

DENON

AV SURROUND RECEIVER

AVR-3802/1082

OPERATING INSTRUCTIONS
BEDIENUNGSANLEITUNG
MODE D'EMPLOI
ISTRUZIONI PER L'USO

INSTRUCCIONES DE OPERACION
GEBRUIKSAANWIJZING
BRUKSANVISNING

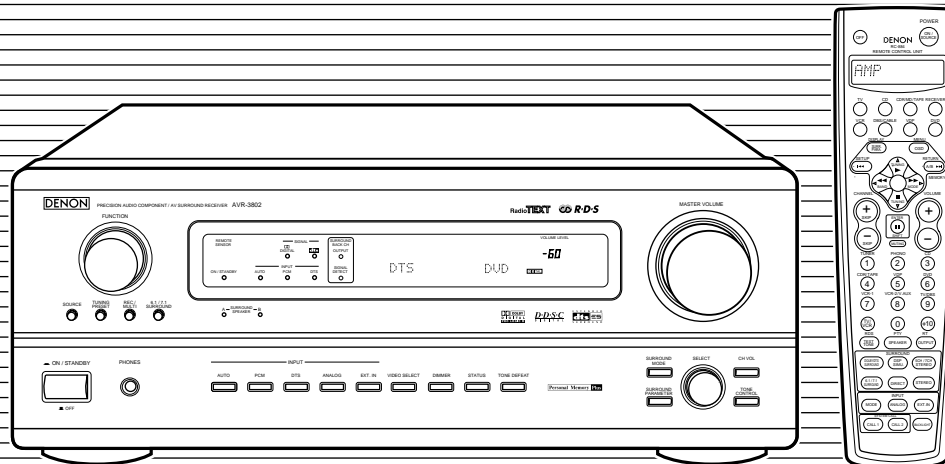

FOR ENGLISH READERS	PAGE	2 ~ PAGE	42
FÜR DEUTSCHE LESER	SEITE	43 ~ SEITE	82
POUR LES LECTEURS FRANCAIS	PAGE	83 ~ PAGE	122
PER IL LETTORE ITALIANO	PAGINA	123 ~ PAGINA	162
PARA LECTORES DE ESPAÑOL	PAGINA	163 ~ PAGINA	202
VOOR NEDERLANDSTALIGE LEZERS	PAGINA	203 ~ PAGINA	242
FOR SVENSKA LÄSARE	SIDA	243 ~ SIDA	282



CAUTION
RISK OF ELECTRIC SHOCK
DO NOT OPEN



CAUTION: TO REDUCE THE RISK OF ELECTRIC SHOCK, DO NOT REMOVE COVER (OR BACK). NO USER SERVICEABLE PARTS INSIDE. REFER SERVICING TO QUALIFIED SERVICE PERSONNEL.



The lightning flash with arrowhead symbol, within an equilateral triangle, is intended to alert the user to the presence of uninsulated "dangerous voltage" within the product's enclosure that may be of sufficient magnitude to constitute a risk of electric shock to persons.



The exclamation point within an equilateral triangle is intended to alert the user to the presence of important operating and maintenance (servicing) instructions in the literature accompanying the appliance.

WARNING: TO REDUCE THE RISK OF FIRE OR ELECTRIC SHOCK, DO NOT EXPOSE THIS APPLIANCE TO RAIN OR MOISTURE.

NOTE ON USE / HINWEISE ZUM GEBRAUCH / OBSERVATIONS RELATIVES A L'UTILISATION / NOTE SULL'USO NOTAS SOBRE EL USO / ALVORENS TE GEBRUIKEN / OBSERVERA

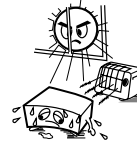

- Avoid high temperatures. Allow for sufficient heat dispersion when installed on a rack.
- Vermeiden Sie hohe Temperaturen. Beachten Sie, daß eine ausreichend Luftzirkulation gewährleistet wird, wenn das Gerät auf ein Regal gestellt wird.
- Eviter des températures élevées. Tenir compte d'une dispersion de chaleur suffisante lors de l'installation sur une étagère.
- Evitate di esporre l'unità a temperature alte. Assicuratevi che ci sia un'adeguata dispersione del calore quando installate l'unità in un mobile per componenti audio.
- Evite altas temperaturas. Permita la suficiente dispersión del calor cuando está instalado en la consola.
- Vermijd hoge temperaturen. Zorg voor een degelijk hitteafvoer indien het apparaat op een rek wordt geplaatst.
- Undvik höga temperaturer. Se till att det finns möjlighet till god värmeavledning vid montering i ett rack.



- Keep the set free from moisture, water, and dust.
- Halten Sie das Gerät von Feuchtigkeit, Wasser und Staub fern.
- Protéger l'appareil contre l'humidité, l'eau et l'apoussièrè.
- Tenete l'unità lontana dall'umidità, dall'acqua e dalla polvere.
- Mantenga el equipo libre de humedad, agua y polvo.
- Laat geen vochtigheid, water of stof in het apparaat binnendringen.
- Utsätt inte apparaten för fukt, vatten och damm.



- Do not let foreign objects in the set.
- Keine fremden Gegenstände in das Gerät kommen lassen.
- Ne pas laisser des objets étrangers dans l'appareil.
- E' importante che nessun oggetto è inserito all'interno dell'unità.
- No deje objetos extraños dentro del equipo.
- Laat geen vreemde voorwerpen in dit apparaat vallen.
- Se till att främmande föremål inte tränger in i apparaten.

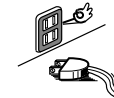

- Unplug the power cord when not using the set for long periods of time.
- Wenn das Gerät eine längere Zeit nicht verwendet werden soll, trennen Sie das Netzkabel vom Netzstecker.
- Débrancher le cordon d'alimentation lorsque l'appareil n'est pas utilisé pendant de longues périodes.
- Disinnestate il filo di alimentazione quando avete l'intenzione di non usare il filo di alimentazione per un lungo periodo di tempo.
- Desconecte el cordón de energía cuando no utilice el equipo por mucho tiempo.
- Neem altijd het netsnoer uit het stopcontact wanneer het apparaat gedurende een lange periode niet wordt gebruikt.
- Koppla ur nätkabeln om apparaten inte kommer att användas i lång tid.



- Do not let insecticides, benzene, and thinner come in contact with the set.
- Lassen Sie das Gerät nicht mit Insektiziden, Benzin oder Verdünnungsmitteln in Berührung kommen.
- Ne pas mettre en contact des insecticides, du benzène et un diluant avec l'appareil.
- Assicuratevi che l'unità non venga in contatto con insetticidi, benzolo o solventi.
- No permita el contacto de insecticidas, gasolina y diluyentes con el equipo.
- Laat geen insektenverdelgende middelen, benzine of verfverdunder met dit apparaat in contact komen.
- Se till att inte insektsmedel på spraybruk, bensen och thinner kommer i kontakt med apparatens hölje.



- Handle the power cord carefully. Hold the plug when unplugging the cord.
- Gehen Sie vorsichtig mit dem Netzkabel um. Halten Sie das Kabel am Stecker, wenn Sie den Stecker herausziehen.
- Manipuler le cordon d'alimentation avec précaution. Tenir la prise lors du débranchement du cordon.
- Maneggiare il filo di alimentazione con cura. Agite per la spina quando scollegate il cavo dalla presa.
- Maneje el cordón de energía con cuidado. Sostenga el enchufe cuando desconecte el cordón de energía.
- Hanteer het netsnoer voorzichtig. Houd het snoer bij de stekker vast wanneer deze moet worden aan- of losgekoppeld.
- Hantera nätkabeln varsamt. Håll i kabeln när den kopplas från el-uttaget.

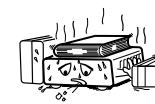

- * (For sets with ventilation holes)
- Do not obstruct the ventilation holes.
- Die Belüftungsöffnungen dürfen nicht verdeckt werden.
- Ne pas obstruer les trous d'aération.
- Non coprite i fori di ventilazione.
- No obstruya los orificios de ventilación.
- De ventilatieopeningen mogen niet worden geblokkeerd.
- Täpp inte till ventilationsöppningarna.



- Never disassemble or modify the set in any way.
- Versuchen Sie niemals das Gerät auseinander zu nehmen oder auf jegliche Art zu verändern.
- Ne jamais démonter ou modifier l'appareil d'une manière ou d'une autre.
- Non smontate mai, né modificate l'unità in nessun modo.
- Nunca desarme o modifique el equipo de ninguna manera.
- Nooit dit apparaat demonteren of op andere wijze modifieren.
- Ta inte isär apparaten och försök inte bygga om den.

DECLARATION OF CONFORMITY

We declare under our sole responsibility that this product, to which this declaration relates, is in conformity with the following standards: EN60065, EN55013, EN55020, EN61000-3-2 and EN61000-3-3. Following the provisions of 73/23/EEC, 89/336/EEC and 93/68/EEC Directive.

ÜBEREINSTIMMUNGSERKLÄRUNG

Wir erklären unter unserer Verantwortung, daß dieses Produkt, auf das sich diese Erklärung bezieht, den folgenden Standards entspricht: EN60065, EN55013, EN55020, EN61000-3-2 und EN61000-3-3. Entspricht den Verordnungen der Direktive 73/23/EEC, 89/336/EEC und 93/68/EEC.

DECLARATION DE CONFORMITE

Nous déclarons sous notre seule responsabilité que l'appareil, auquel se réfère cette déclaration, est conforme aux standards suivants: EN60065, EN55013, EN55020, EN61000-3-2 et EN61000-3-3. D'après les dispositions de la Directive 73/23/EEC, 89/336/EEC et 93/68/EEC.

DICHIARAZIONE DI CONFORMITÀ

Dichiaro con piena responsabilità che questo prodotto, al quale la nostra dichiarazione si riferisce, è conforme alle seguenti normative: EN60065, EN55013, EN55020, EN61000-3-2 e EN61000-3-3. In conformità con le condizioni delle direttive 73/23/EEC, 89/336/EEC e 93/68/EEC. QUESTO PRODOTTO E' CONFORME AL D.M. 28/08/95 N. 548

DECLARACIÓN DE CONFORMIDAD

Declaramos bajo nuestra exclusiva responsabilidad que este producto al que hace referencia esta declaración, está conforme con los siguientes estándares: EN60065, EN55013, EN55020, EN61000-3-2 y EN61000-3-3. Siguiendo las provisiones de las Directivas 73/23/EEC, 89/336/EEC y 93/68/EEC.

EENVORMIGHEIDSVKLRING

Wij verklaren uitsluitend op onze verantwoordelijkheid dat dit product, waarop deze verklaring betrekking heeft, in overeenstemming is met de volgende normen: EN60065, EN55013, EN55020, EN61000-3-2 en EN61000-3-3. Volgens de bepalingen van de Richtlijnen 73/23/EEC, 89/336/EEC en 93/68/EEC.

ÖVERENSSTÄMMELSESINTYG

Härmed intygas helt på eget ansvar att denna produkt, vilken detta intyg avser, uppfyller följande standarder: EN60065, EN55013, EN55020, EN61000-3-2 och EN61000-3-3. Enligt stadgarna i direktiv 73/23/EEC, 89/336/EEC och 93/68/EEC.

- We greatly appreciate your purchase of the AVR-3802.
- To be sure you take maximum advantage of all the features the AVR-3802 has to offer, read these instructions carefully and use the set properly. Be sure to keep this manual for future reference, should any questions or problems arise.

“SERIAL NO. _____
PLEASE RECORD UNIT SERIAL NUMBER ATTACHED TO THE REAR OF THE
CABINET FOR FUTURE REFERENCE”

■ INTRODUCTION

Thank you for choosing the DENON AVR-3802 Digital Surround A / V receiver. This remarkable component has been engineered to provide superb surround sound listening with home theater sources such as DVD, as well as providing outstanding high fidelity reproduction of your favorite music sources. As this product is provided with an immense array of features, we recommend that before you begin hookup and operation that you review the contents of this manual before proceeding.

TABLE OF CONTENTS

1 Before Using.....3	10 Surround.....27~29
2 Cautions on Installation.....3	11 DSP Surround Simulation.....30~32
3 Cautions on Handling.....3	12 Listening to the Radio.....33~35
4 Features.....4	13 Last Function Memory.....36
5 Connections.....4~8	14 Initialization of the Microprocessor.....36
6 Part Names and Functions.....8, 9	15 Troubleshooting.....36, 37
7 Setting up the system.....9~16	16 Additional Information.....37~41
8 Remote Control Unit.....16~22	17 Specifications.....42
9 Operation.....22~26	

■ ACCESSORIES

Check that the following parts are included in addition to the main unit:

- | | |
|--------------------------------------|----------------------------|
| ① Operating instructions.....1 | ⑤ AM loop antenna.....1 |
| ② Service station list.....1 | ⑥ FM indoor antenna.....1 |
| ③ Remote control unit (RC-884).....1 | ⑦ FM antenna adaptor.....1 |
| ④ R6P/AA batteries.....3 | |

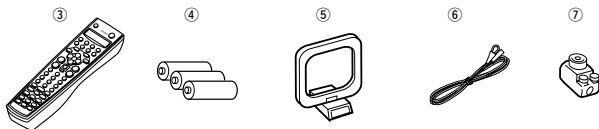

1 BEFORE USING

Pay attention to the following before using this unit:

- **Moving the set**
To prevent short circuits or damaged wires in the connection cords, always unplug the power cord and disconnect the connection cords between all other audio components when moving the set.
- **Store this instructions in a safe place.**
After reading, store this instructions along with the warranty in a safe place.
- **Before turning the power switch on**
Check once again that all connections are proper and that there are not problems with the connection cords. Always set the power switch to the standby position before connecting and disconnecting connection cords.
- **Note that the illustrations in this instructions may differ from the actual set for explanation purposes.**

2 CAUTIONS ON INSTALLATION

Noise or disturbance of the picture may be generated if this unit or any other electronic equipment using microprocessors is used near a tuner or TV. If this happens, take the following steps:

- Install this unit as far as possible from the tuner or TV.
- Set the antenna wires from the tuner or TV away from this unit's power cord and input/output connection cords.
- Noise or disturbance tends to occur particularly when using indoor antennas or 300 Ω/ohms feeder wires. **We recommend using outdoor antennas and 75 Ω/ohms coaxial cables.**

For heat dispersal, leave at least 10 cm of space between the top, back and sides of this unit and the wall or other components.

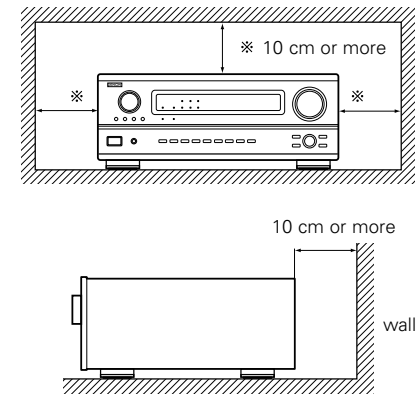

3 CAUTIONS ON HANDLING

- **Switching the input function when input jacks are not connected**
A clicking noise may be produced if the input function is switched when nothing is connected to the input jacks. If this happens, either turn down the MASTER VOLUME control or connect components to the input jacks.
- **Muting of PRE OUT jacks, HEADPHONE jacks and SPEAKER terminals**
The PRE OUT jacks, HEADPHONE jacks and SPEAKER terminals include a muting circuit. Because of this, the output signals are greatly reduced for several seconds after the power switch is turned on or input function, surround mode or any other-set-up is changed. If the volume is turned up during this time, the output will be very high after the muting circuit stops functioning. Always wait until the muting circuit turns off before adjusting the volume.
- **Whenever the power switch is in the OFF state, the apparatus is still connected on AC line voltage.**
Please be sure to unplug the cord when you leave home for, say, a vacation.

4 FEATURES

- Digital Surround Sound Decoding**
 Featuring 32 bit high speed DSP, operating entirely in digital domain, surround sound from digital sources such as DVD, LD, DTV and satellite are faithfully re-created.
- Dolby Pro Logic II decoder**
 Dolby Pro Logic II is a new format for playing multichannel audio signals that offers improvements over conventional Dolby Pro Logic. It can be used to decode not only sources recorded in Dolby Surround but also regular stereo sources into five channels (front left/right, center and surround left/right). In addition, various parameters can be set according to the type of source and the contents, so you can adjust the sound field with greater precision.
- Dolby Digital**
 Using advanced digital processing algorithms, Dolby Digital provides up to 5.1 channels of wide-range, high fidelity surround sound. Dolby Digital is the default digital audio delivery system for North American DVD and DTV.
- DTS (Digital Theater Systems)**
 DTS provides up to 5.1 channels of wide-range, high fidelity surround sound, from sources such as laser disc, DVD and specially-encoded music discs.
- DTS-ES Extended Surround and DTS Neo:6**
 The AVR-3802 is compatible with DTS-ES Extended Surround, a new multi-channel format developed by Digital Theater Systems Inc.
 The AVR-3802 is also compatible with DTS Neo:6, a surround mode allowing 6.1-channel playback of regular stereo sources.
- Wide screen mode for a 7.1-channel sound even with 5.1-channel sources**
 DENON has developed a wide screen mode with a new design which recreates the effects of the multi surround speakers in movie theaters. The result is 7.1-channel sound taking full advantage of surround back speakers, even with Dolby Pro Logic or Dolby Digital/DTS 5.1-channel signals.
- 24 bit D/A Conversion**
 All six channels, including the five main channels and the low frequency effects (LFE) channel benefit from reference, for optimum high fidelity reproduction of music and movie soundtracks.
- Dual Surround Speaker Mode**
 Provides for the first time the ability to optimize surround sound reproduction using two different types of surround sound speakers as well as two different surround speaker positions:

- Movie Surround**
 Motion picture soundtracks use the surround channel(s) to provide the ambient elements of the acoustic environment they want the audience to realize. This is best accomplished by the use of specially-designed surround speakers that offer a wide diffusion pattern (bipolar dispersion) or by using surround speakers that provide broad dispersion with a minimum of on-axis localization (dipolar dispersion). Side wall mounting (closer to the ceiling) of the surround speakers provides the greatest envelopment, minimizing localization of direct sound from the speakers.
 - Music Surround**
 With full range discrete surround channels, as well as three discrete full range front channels, digital formats such as Dolby and DTS offer thrilling surround sound music listening. Producers of multi-channel discrete digital music recordings almost always favor the use of direct radiating (monopolar) surround speakers, placed in the rear corners of the room, since that is how they configure their studios during the mixing/creation process. The DENON AVR-3802 provides the ability to connect two different sets of surround speakers, and place them in the appropriate locations in your AV theater room, so that you can enjoy both movie soundtracks and music listening, with optimum results and no compromise.
- Component Video Switching**
 In addition to composite video and "S" video switching, the AVR-3802 provides 2 sets of component video (Y, PB/CB, PR/CR) inputs for the DVD and TV/DBS inputs, and one set of component video outputs to the television, for superior picture quality.
 - Video Select Function**
 Allow you to watch one source (visual) while listening to another source (audio).
 - Future Sound Format Upgrade Capability via Eight Channel Inputs & Outputs**
 For future multi-channel audio format(s), the AVR-3802 is provided with 7.1 channel (seven main channels, plus one low frequency effects channel) inputs, along with a full set of 7.1 channel pre-amp outputs, controlled by the 8 channel master volume control. This assures future upgrade possibilities for any future multi-channel sound format.

5 CONNECTIONS

- Do not plug in the AC cord until all connections have been completed.
- Be sure to connect the left and right channels properly (left with left, right with right).
- Insert the plugs securely. Incomplete connections will result in the generation of noise.
- Use the AC OUTLET for audio equipment only. Do not use them for hair driers, etc.**
- Note that binding pin plug cords together with AC cords or placing them near a power transformer will result in generating hum or other noise.
- Noise or humming may be generated if a connected audio equipment is used independently without turning the power of this unit on. If this happens, turn on the power of the this unit.

Connecting the audio components

- When making connections, also refer to the operating instructions of the other components.
 The power to this outlet is turned on and off when the power is switched between on and standby from the remote control unit or power switch.

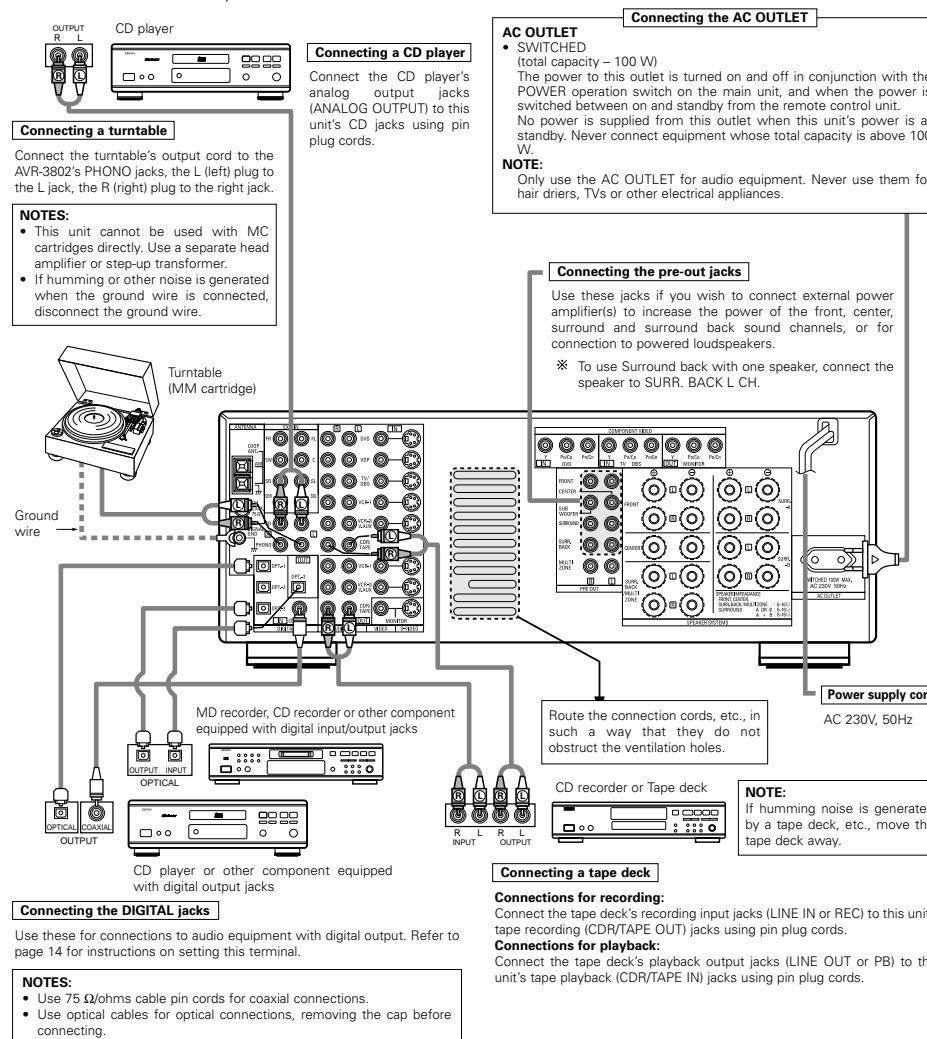

Connecting video components

- To connect the video signal, connect using a 75 Ω/ohms video signal cable cord. Using an improper cable can result in a drop in video quality.
- When making connections, also refer to the operating instructions of the other components.

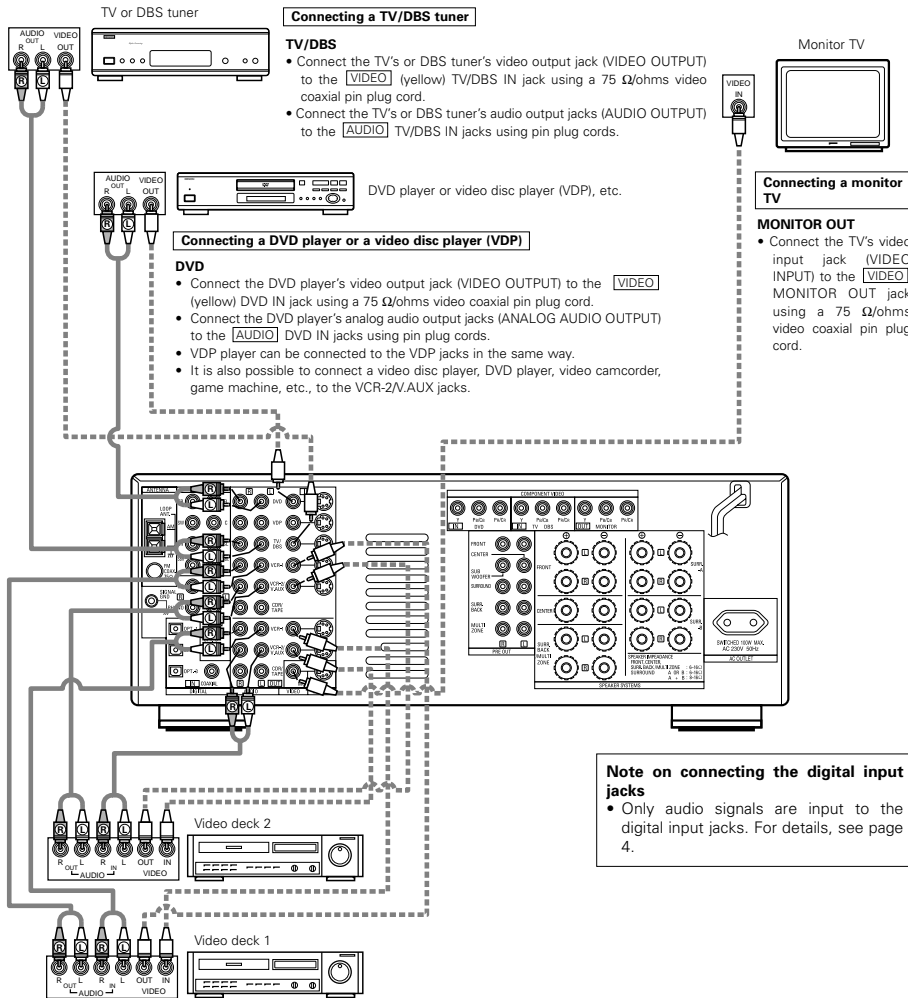

Connecting a video component equipped with S-Video jacks

- When making connections, also refer to the operating instructions of the other components.
- A note on the S input jacks**
The input selectors for the S inputs and pin jack inputs work in conjunction with each other.
- Precaution when using S-jacks**

This unit's S-jacks (input and output) and video pin jacks (input and output) have independent circuit structures, so that video signals input from the S-jacks are only output from the S-jack outputs and video signals input from the pin jacks are only output from the pin jack outputs. When connecting this unit with equipment that is equipped with S-jacks, keep the above point in mind and make connections according to the equipment's instruction manuals.

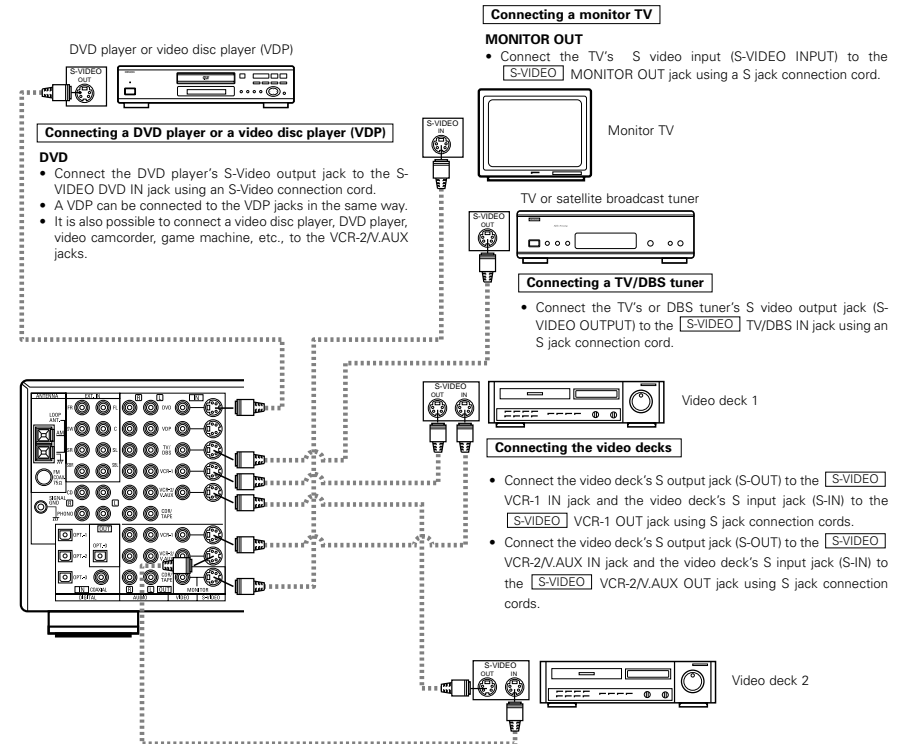

Connecting a video decks

- There are two sets of video deck (VCR) jacks, so two video decks can be connected for simultaneous recording or video copying.

Video input/output connections:

- Connect the video deck's video output jack (VIDEO OUT) to the [VIDEO] (yellow) VCR-1 IN jack, and the video deck's video input jack (VIDEO IN) to the [VIDEO] (yellow) VCR-1 OUT jack using 75 Ω/ohms video coaxial pin plug cords.

Connecting the audio output jacks

- Connect the video deck's audio output jacks (AUDIO OUT) to the [AUDIO] VCR-1 IN jacks, and the video deck's audio input jacks (AUDIO IN) to the [AUDIO] VCR-1 OUT jacks using pin plug cords.

※ Connect the second video deck to the VCR-2/V.AUX jacks in the same way.

Connecting a Video Component Equipped with Color Difference (Component - Y, Pr/CR, Pb/CB) Video Jacks (DVD Player)

- When making connections, also refer to the operating instructions of the other components.
- The signals input to the color difference (component) video jacks are not output from the VIDEO output jack (yellow) or the S-Video output jack. In addition, the video signals input to the VIDEO input (yellow) and S-Video input jacks are not output to the color difference (component) video jacks.
- The AVR-3802's on-screen display signals are not output from the color difference (component) video output jacks (MONITOR OUT).
- Some video sources with component video outputs are labeled Y, Cb, Cr, or Y, Pb, Pr, or Y, R-Y, B-Y. These terms all refer to component video color difference output.

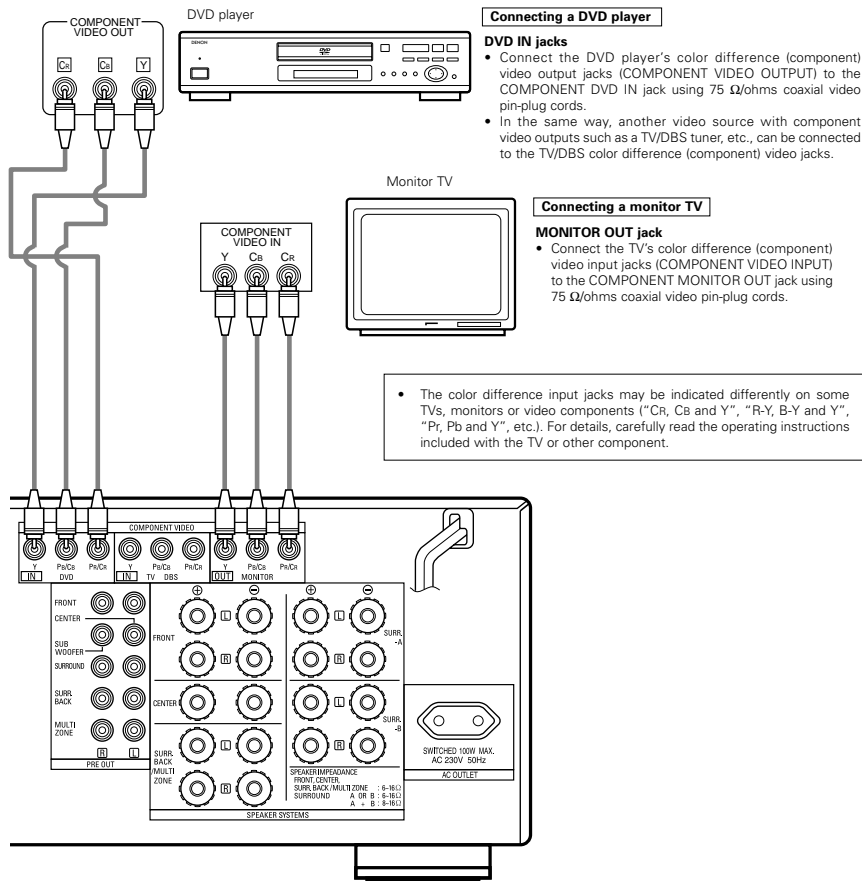

Connecting the antenna terminals

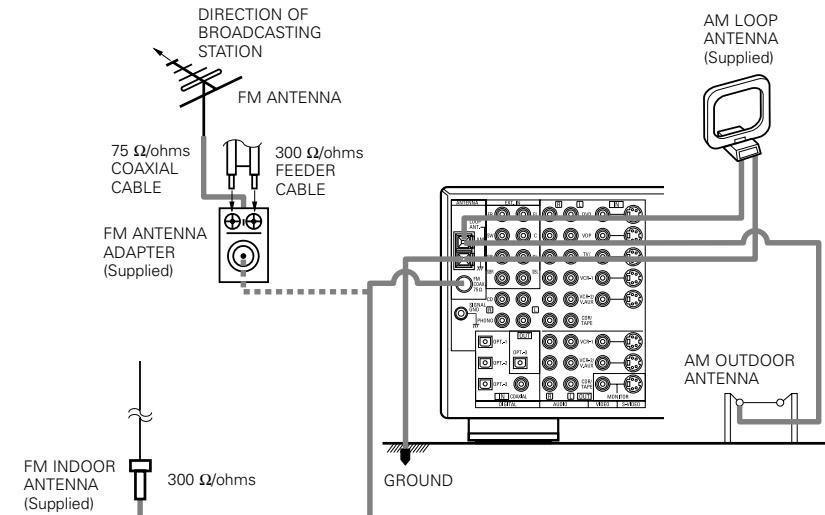

- An F-type FM antenna cable plug can be connected directly.
- If the FM antenna cable's plug is not of the F-type, connect using the included antenna adapter.

AM loop antenna assembly

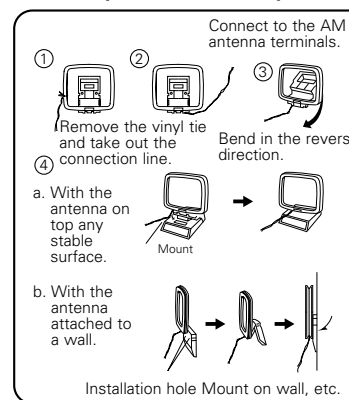

FM antenna adapter assembly

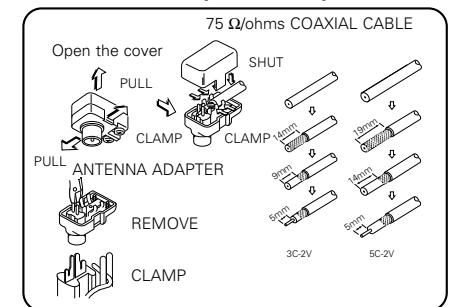

Connection of AM antennas

1. Push the lever.
2. Insert the conductor.
3. Return the lever.

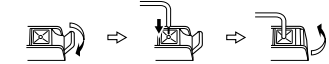

Notes:

- Do not connect two FM antennas simultaneously.
- Even if an external AM antenna is used, do not disconnect the AM loop antenna.
- Make sure AM loop antenna lead terminals do not touch metal parts of the panel.

Connecting the external input (EXT. IN) jacks

- These jacks are for inputting multi-channel audio signals from an outboard decoder, or a component with a different type of multi-channel decoder, such as a DVD Audio player, or a multi-channel SACD player, or other future multi-channel sound format decoder.
- When making connections, also refer to the operating instructions of the other components.

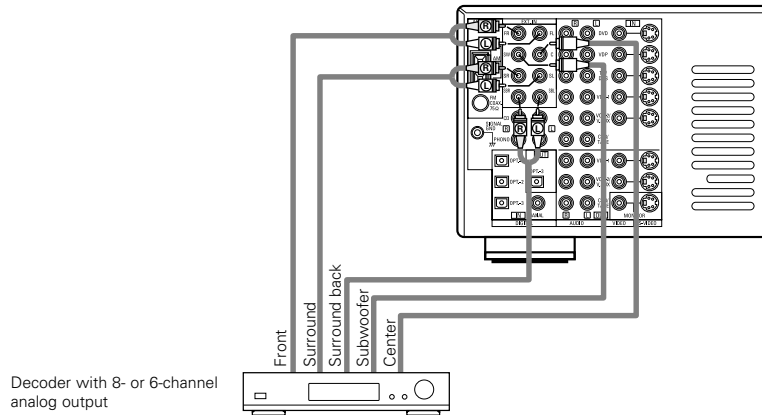

※ For instructions on playback using the external input (EXT. IN) jacks, see page 24.

Connecting the MULTI ZONE jacks

- If another pre-main (integrated) amplifier or power amplifier is connected, the multi-source jacks can be used to play a different program source in another room at the same time.

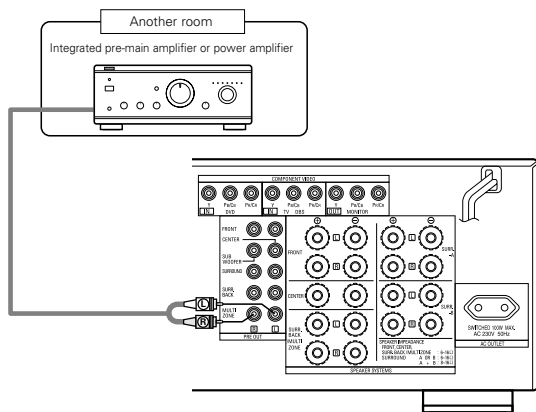

※ For instructions on operations using the MULTI ZONE jacks, see pages 25, 26.

Speaker system connections

- Connect the speaker terminals with the speakers making sure that like polarities are matched (⊕ with ⊕ , ⊖ with ⊖). Mismatching of polarities will result in weak central sound, unclear orientation of the various instruments, and the sense of direction of the stereo being impaired.
- When making connections, take care that none of the individual conductors of the speaker cord come in contact with adjacent terminals, with other speaker cord conductors, or with the rear panel.

Speaker Impedance

- Speakers with an impedance of from 6 to 16 Ω/ohms can be connected for use as front and center speakers.
- Speakers with an impedance of 6 to 16 Ω/ohms can be connected for use as surround and surround back speakers.
- Be careful when using two pairs of surround speakers (A + B) at the same time, since use of speakers with an impedance of less than 8 Ω/ohms will lead to damage.
- The protector circuit may be activated if the set is played for long periods of time at high volumes when speakers with an impedance lower than the specified impedance are connected.

NOTE:
NEVER touch the speaker terminals when the power is on.
Doing so could result in electric shocks.

Connecting the speaker cords

1. Loosen by turning counterclockwise.
2. Insert the cord.
3. Tighten by turning clockwise.

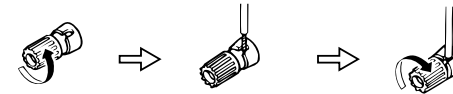

Protector circuit

- This unit is equipped with a high-speed protection circuit. The purpose of this circuit is to protect the speakers under circumstances such as when the output of the power amplifier is inadvertently short-circuited and a large current flows, when the temperature surrounding the unit becomes unusually high, or when the unit is used at high output over a long period which results in an extreme temperature rise. When the protection circuit is activated, the speaker output is cut off and the power supply indicator LED flashes. Should this occur, please follow these steps: be sure to switch off the power of this unit, check whether there are any faults with the wiring of the speaker cables or input cables, and wait for the unit to cool down if it is very hot. Improve the ventilation condition around the unit and switch the power back on. If the protection circuit is activated again even though there are no problems with the wiring or the ventilation around the unit, switch off the power and contact a DENON service center.

Note on speaker impedance

- The protector circuit may be activated if the set is played for long periods of time at high volumes when speakers with an impedance lower than the specified impedance (for example speakers with an impedance of lower than 4 Ω/ohms) are connected. If the protector circuit is activated, the speaker output is cut off. Turn off the set's power, wait for the set to cool down, improve the ventilation around the set, then turn the power back on.

Connections

- When making connections, also refer to the operating instructions of the other components.

Connection jack for subwoofer with built-in amplifier (super woofer), etc.

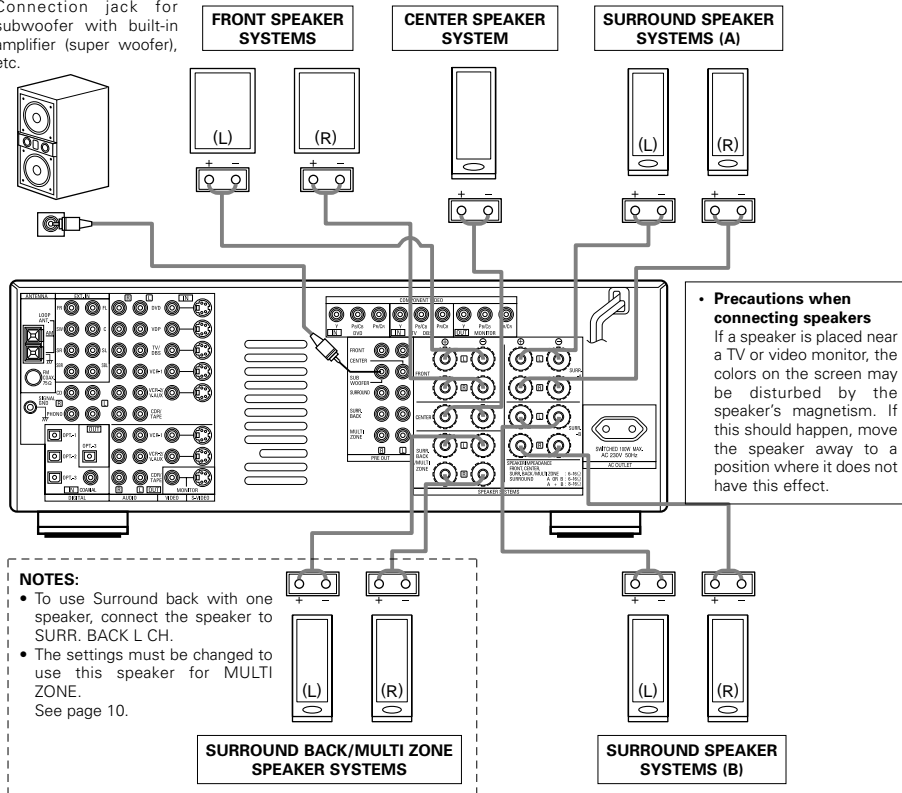

NOTES:

- To use Surround back with one speaker, connect the speaker to SURR. BACK L CH.
- The settings must be changed to use this speaker for MULTI ZONE. See page 10.

6 PART NAMES AND FUNCTIONS

Front Panel

- For details on the functions of these parts, refer to the pages given in parentheses ().

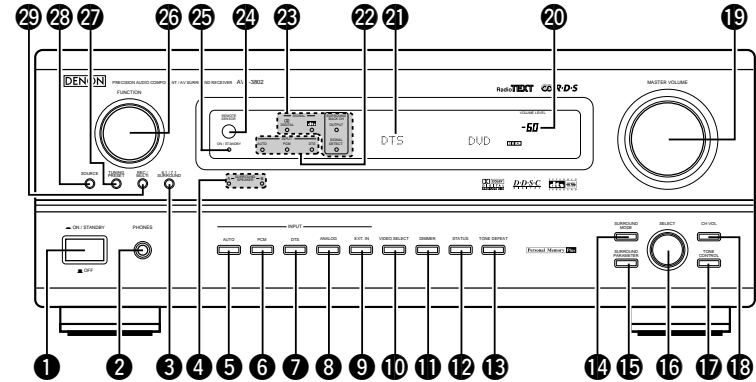

- | | |
|---|--|
| 1 Power operation switch(22) | 16 SELECT knob.....(23) |
| 2 Headphones jack (PHONES)(24) | 17 TONE CONTROL button(24) |
| 3 6.1/7.1 SURROUND button.....(29) | 18 CH VOL button.....(27) |
| 4 Surround speaker system indicators (SURROUND SPEAKER A/B) | 19 MASTER VOLUME control(23) |
| 5 AUTO button(23) | 20 Master volume indicator (VOLUME LEVEL) ..(23) |
| 6 PCM button(23) | 21 Display |
| 7 DTS button(23) | 22 INPUT mode indicators(23) |
| 8 ANALOG button(23) | 23 SIGNAL indicators(23) |
| 9 EXT. IN button(23) | 24 Remote control sensor (REMOTE SENSOR)(16) |
| 10 VIDEO SELECT button(25) | 25 Power indicator(22) |
| 11 DIMMER button(25) | 26 FUNCTION knob.....(23) |
| 12 STATUS button(25) | 27 TUNING PRESET button(34) |
| 13 TONE DEFEAT button(24) | 28 SOURCE selector button(23) |
| 14 SURROUND MODE button.....(23) | 29 REC/MULTI button(25) |
| 15 SURROUND PARAMETER button(28) | |

7 SETTING UP THE SYSTEM

- Once all connections with other AV components have been completed as described in "CONNECTIONS" (see pages 4 to 8), make the various settings described below on the monitor screen using the AVR-3802's on-screen display function.
- These settings are required to set up the listening room's AV system centered around the AVR-3802.
- Use the following buttons to set up the system:

Remote control unit

- For details on the functions of these parts, refer to the pages given in parentheses ().

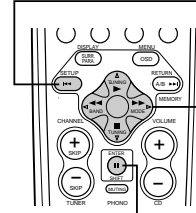
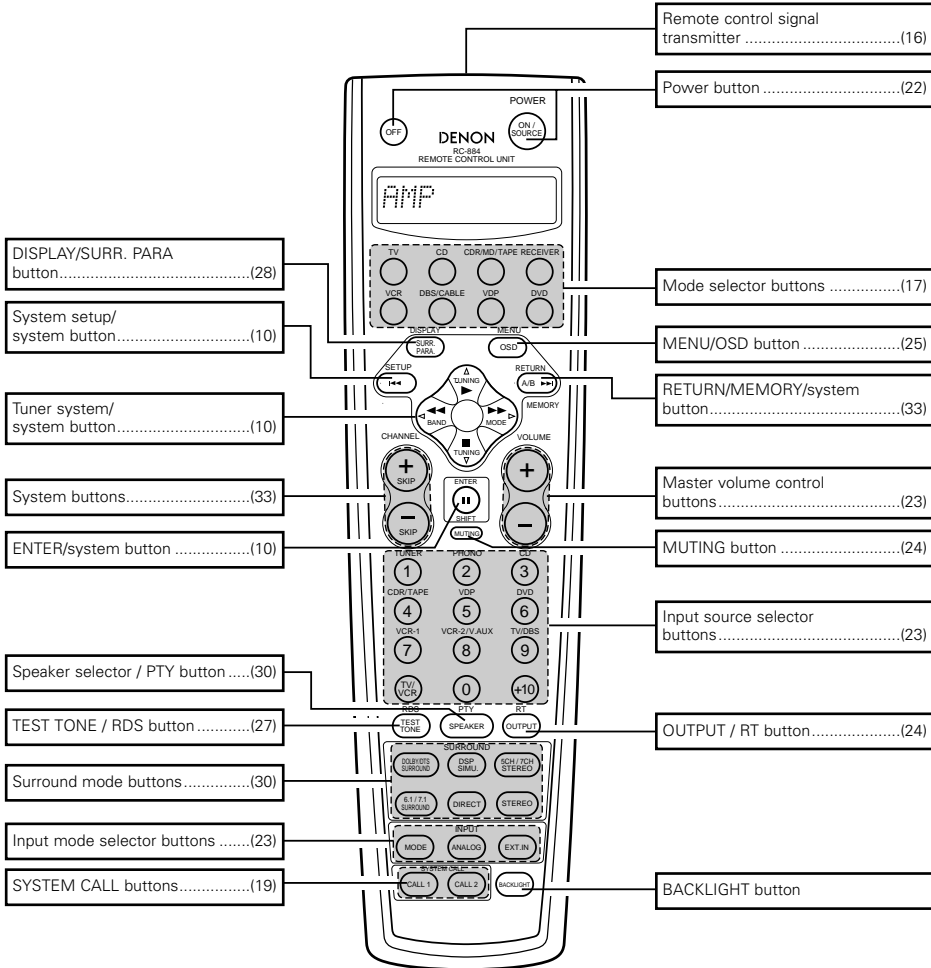

SYSTEM SETUP button
Press this to display the system setup menu.

CURSOR buttons
◀ and ▶: Use these to move the cursors (◀ and ▶) to the left and right on the screen.
△ and ▽: Use these to move the cursors (△ and ▽) to the up and down on the screen.

ENTER button
Press this to switch the display.
Also use this button to complete the setting.

- System setup items and default values (set upon shipment from the factory)

System setup		Default settings									
①	Power AMP Assignment	Set this to switch the surround back channel's power amplifier for use for multi-zone.	Surround Back								
②	Speaker Configuration	Input the combination of speakers in your system and their corresponding sizes (SMALL for regular speakers, LARGE for full-size, full-range) to automatically set the composition of the signals output from the speakers and the frequency response.	Surround mode	Front Sp.	Center Sp.	Sub Woofer	Surround Sp. A/B	Surround Back Sp.			
			Surround speaker	Large	Small	Yes	Small	Small / 2spkr			
②	(Surround Speaker Setting)	Use this function when using multiple surround speaker combinations for more ideal surround sound. Once the combinations of surround speakers to be used for the different surround modes are preset, the surround speakers are selected automatically according to the surround mode.	Surround mode	DOLBY/DTS SURROUND	5CH/7CH STEREO	DSP SIMULATION	EXT. IN	—			
			Surround speaker	A	A	A	A	—			
②	Crossover Frequency	Set the frequency (Hz) below which the bass sound of the various speakers is to be output from the subwoofer.	80 Hz								
	(Subwoofer mode)	This selects the subwoofer speaker for playing deep bass signals.	LFE								
③	SB CH Auto Flag Detect	Set the method of playing the surround backchannel for digital signals.	DTS-ES / 6.1 Source Auto Flag Detect Mode = OFF								
④	Delay Time	This parameter is for optimizing the timing with which the audio signals are produced from the speakers and subwoofer according to the listening position.	Front L & R	Center	Sub Woofer	Surround L & R	SBL & SBR				
			3.6 m (12 ft)	3.6 m (12 ft)	3.6 m (12 ft)	3.0 m (10 ft)	3.0 m (10 ft)				
⑤	Channel Level	This adjusts the volume of the signals output from the speakers and subwoofer for the different channels in order to obtain optimum effects.	Front L	Front R	Center	Surround L	Surround R	Surround Back L	Surround Back R	Subwoofer	
			0 dB	0 dB	0 dB	0 dB	0 dB	0 dB	0 dB	0 dB	
⑥	Digital In Assignment	This assigns the digital input jacks for the different input sources.	Input source	CD	DVD	TV/DBS	CDR /TAPE	VDP	VCR-1	VCR-2	—
			Digital Inputs	COAXIAL	OPTICAL 1	OPTICAL 2	OPTICAL 3	OFF	OFF	OFF	—
⑦	Multi vol. Level	This sets the output level for the multi output jacks.	0 dB								
⑧	On Screen Display	This sets whether or not to display the on-screen display that appears on the monitor screen when the controls on the remote control unit or main unit are operated.	On Screen Display = ON								
⑨	Auto Tuner Preset	FM stations are received automatically and stored in the memory.	A1 ~ A8	87.5 / 89.1 / 98.1 / 108.0 / 90.1 / 90.1 / 90.1 / 90.1 MHz							
			B1 ~ B8	522 / 603 / 999 / 1404 / 1611 kHz, 90.1 / 90.1 MHz							
			C1 ~ C8	90.1 MHz							
			D1 ~ D8	90.1 MHz							
			E1 ~ E8	90.1 MHz							

NOTES:

- The on-screen display signals are not output from the color difference (component) video signal (MONITOR OUT) jacks.
- The on-screen display signals are output with priority to the S-VIDEO MONITOR OUT jack during playback of a video component. For example, if the TV monitor is connected to both the AVR-3802's S-Video and video monitor output jacks and signals are input to the AVR-3802 from a video source (VDP, etc.) connected to both the S-Video and video input jacks, the on-screen display signals are output with priority to the S-Video monitor output. If you wish to output the signals to the video monitor output jack, do not connect a cord to the S-VIDEO MONITOR OUT jack. (For details, see page 16.)
- The AVR-3802's on-screen display function is designed for use with high resolution monitor TVs, so it may be difficult to read small characters on TVs with small screens or low resolutions.
- The setup menu is not displayed when "HEADPHONE ONLY" is selected.

• Speaker system layout

Basic system layout

- The following is an example of the basic layout for a system consisting of eight speaker systems and a television monitor:

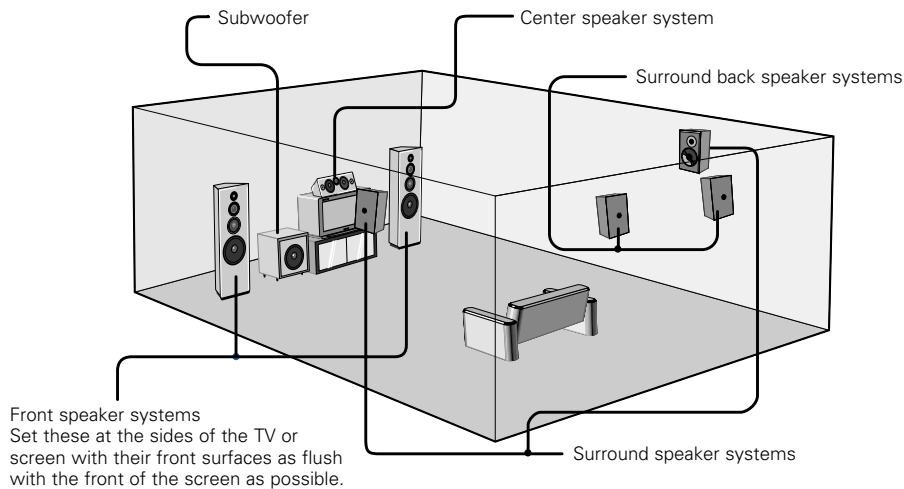

With the AVR-3802 it is also possible to use the surround speaker selector function to choose the best layout for a variety of sources and surround modes.

• Surround speaker selector function

This function makes it possible to achieve the optimum sound fields for different sources by switching between two systems of surround speakers (A and B).

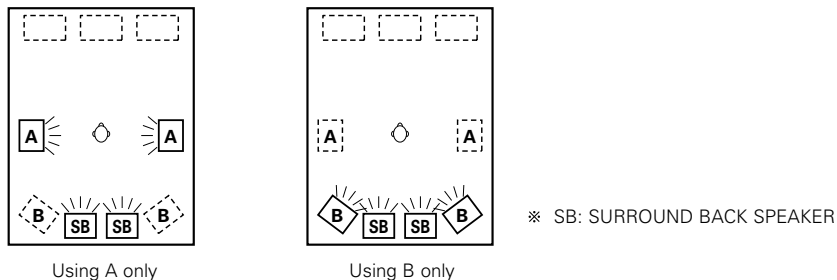

Before setting up the system

1 Check that all the connections are correct, then turn on the main unit's power.

2  Display the System Setup Menu.

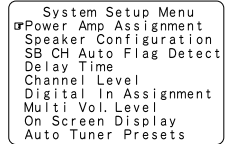

Setting the power amplifier assignment

Make this setting to switch the power amplifier for the surround back channel to Multi.

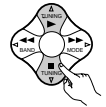
1  At the System Setup Menu, select "Power Amp Assignment" and press the ENTER button.

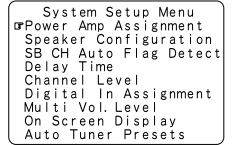

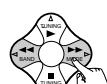
2  Select "Surround Back" to use as the surround back channel, "Multi" to use as multi zone out.

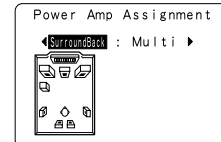

When "Surround Back" is selected

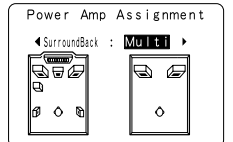

When "Multi" is selected

3  Enter the setting. The System Setup Menu reappears.

Setting the type of speakers

- The composition of the signals output from the different channels and the frequency response are adjusted automatically according to the combination of speakers actually being used.

1  At the System Setup Menu select "Speaker Configuration".

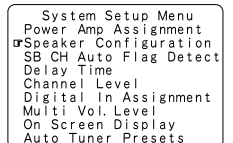

2  Switch to the speaker configuration screen.

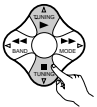
3  Set whether or not speakers are connected and, if so, their size parameters.

- To select the speaker

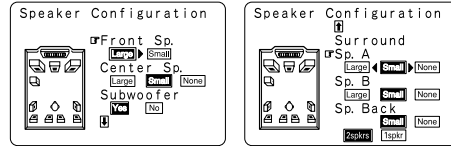

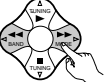
 To select the parameter

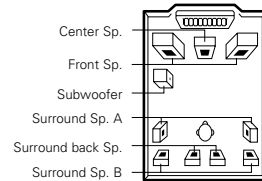

4  Press the ENTER button to finalize the setting.

NOTE:

- Select "Large" or "Small" not according to the actual size of the speaker but according to the speaker's capacity for playing low frequency (bass sound below frequency set for the Crossover Frequency mode and below) signals. If you do not know, try comparing the sound at both settings (setting the volume to a level low enough so as not to damage the speakers) to determine the proper setting.

Parameters

- Large.....Select this when using speakers that have sufficient performance for reproducing bass sound below the frequency set for the Crossover Frequency mode.
- Small.....Select this when using speakers that do not have sufficient performance for reproducing bass sound below the frequency set for the Crossover Frequency mode. When this is set, bass sound with a frequency below the frequency set for the Crossover Frequency mode is sent to the subwoofer. When this setting is selected, low frequencies of below the frequency set for the Crossover Frequency mode are assigned to the subwoofer.
- None.....Select this when no speakers are installed.
- Yes/No.....Select "Yes" when a subwoofer is installed, "No" when a subwoofer is not installed.
- 2spkrs/1spkr.....Set the number of speakers to be used for the surround back channel.

- ※ If the subwoofer has sufficient low frequency playback capacity, good sound can be achieved even when "Small" is set for the front, center and surround speakers.
- ※ For the majority of speaker system configurations, using the Small setting for all five main speakers and Subwoofer On with a connected subwoofer will yield the best results.

Selecting the surround speakers for the different surround modes

This screen is displayed when using both surround speakers A and B.

- At this screen preset the surround speakers to be used in the different surround modes.

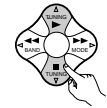
1  When either "Large" or "Small" has been set for both speakers A and B on the System Setup Menu (when using both A and B surround speakers), the surround speaker setting screen appears. Select the surround speakers to be used in the different surround modes.

- To select the surround mode
- To select the surround speaker
- A: When using surround speakers A
- B: When using surround speakers B
- A+B: When using both surround speakers A and B

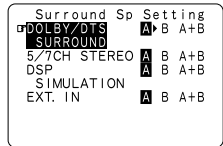

2  Enter the setting. When "Front" is set to "Large" and "Subwoofer" is set to "Yes", the set switches to the subwoofer mode.

※ Speaker type setting when using both surround speakers A and B
If "Small" is set for either surround speakers A or B, the output is the same as when "Small" is set for both A and B.

Setting the Crossover Frequency and Subwoofer mode

This screen is displayed when using a subwoofer.

- Set the crossover frequency and subwoofer mode according to the speaker system being used.

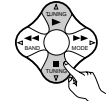
1  Select the "Crossover Frequency" mode.

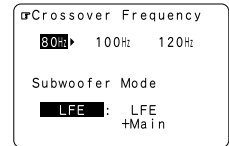

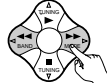
 Select the Frequency.

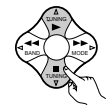
2  Select the "Subwoofer Mode".

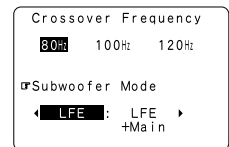

 Select the setting.

3  Enter the setting. The System Setup Menu reappears.

NOTES:

— **Assignment of low frequency signal range —**

- The only signals produced from the subwoofer channel are LFE signals (during playback of Dolby Digital or DTS signals) and the low frequency signal range of channels set to "Small" in the setup menu. The low frequency signal range of channels set to "Large" are produced from those channels.

— **Crossover Frequency —**

- When "Subwoofer" is set to "Yes" at the "Speaker Configuration Setting", set the frequency (Hz) below which the bass sound of the various speakers is to be output from the subwoofer (the crossover frequency).
- For speakers set to "Small", sound with a frequency below the crossover frequency is cut, and the cut bass sound is output from the subwoofer instead.

NOTE: For ordinary speaker systems, we recommend setting the crossover frequency to 80 Hz. When using small speakers, however, setting the crossover frequency to a high frequency may improve frequency response for frequencies near the crossover frequency.

— **Subwoofer mode —**

- The subwoofer mode setting is only valid when "Large" is set for the front speakers and "Yes" is set for the subwoofer in the "Speaker Configuration" settings (see page 10).
- When the "LFE+MAIN" playback mode is selected, the low frequency signal range of channels set to "Large" are produced simultaneously from those channels and the subwoofer channel. In this playback mode, the low frequency range expand more uniformly through the room, but depending on the size and shape of the room, interference may result in a decrease of the actual volume of the low frequency range.
- Selection of the "LFE" play mode will play the low frequency signal range of the channel selected with "Large" from that channel only. Therefore, the low frequency signal range that are played from the subwoofer channel are only the low frequency signal range of LFE (only during Dolby Digital or DTS signal playback) and the channel specified as "Small" in the setup menu.
- Select the play mode that provides bass reproduction with body.
- When the subwoofer is set to "Yes", bass sound is output from the subwoofer regardless of the subwoofer mode setting in surround modes other than Dolby/DTS.

- ② **Non-Flag Source SBCh Output**
MTRX ON: Sources are played using the surround back speaker(s). The surround back channel is played with digital matrix processing.
NON-MTRX: Sources are played using the surround back speaker(s). The same signals as those of the surround channel are output from the surround back speaker(s).
OFF: Sources are played without using the surround back speaker(s).

3



Enter the setting.
The System Setup Menu reappears.

NOTES:

- The "SB CH Auto Flag Detect" setting screen is displayed when the surround back speaker is set to "Large" or "Small" at "Speaker Configuration".
- The surround back speakers can also be turned on and off using the "6.1/7.1 Surround" surround parameter. (See page 29.)

Setting the delay time

- Input the distance between the listening position and the different speakers to set the delay time for the surround mode.
- The delay time can be set separately for surround speakers A and B.

Preparations:

Measure the distances between the listening position and the speakers (L1 to L5 on the diagram at the right).

- L1: Distance between center speaker and listening position
- L2: Distance between front speakers and listening position
- L3: Distance between surround speakers and listening position
- L4: Distance between surround back speakers and listening position
- L5: Distance between subwoofer and listening position

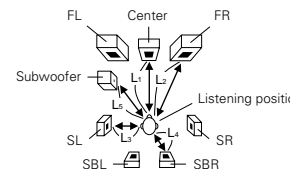

Setting the SB CH Auto Flag Detect

Set the operation for the digital signals when playing in the 6.1 SURROUND and DTS-ES surround modes.

1

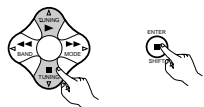

At the System Setup Menu select "SB CH Auto Flag Detect" and press the ENTER button.

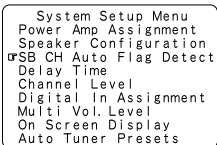

2

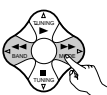

Select the desired setting.
 * We recommend setting this to "OFF".
 When set to "ON", the operation for software for which no identification signals are recorded is set.

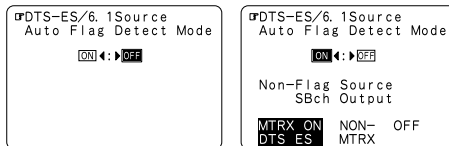

1

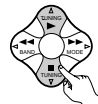

At the System Setup Menu select "Delay Time".

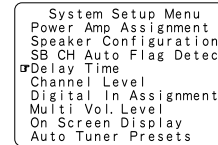

2



Switch to the Delay Time screen.

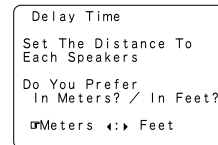

3



Select the desired unit, meters or feet.
 Select (darken) the desired units, "Meters" or "Feet".

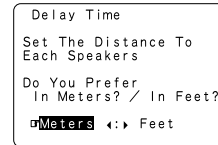

Example: When "Meters" is selected

Setting

- ① **Auto Flag Detect Mode (AFDM)**
ON: This function only works for sources containing DTS-ES or 6.1-channel surround identification signals. When this function is used, sources that have been recorded in 6.1-channel surround or DTS-ES are automatically played in the 6.1-channel surround mode using the surround back speaker(s). (Refer to ② for the method of playback of the surround back speaker in this case.)
OFF: Set this mode if you wish to play normal 5.1-channel sources or sources not containing the identification signals described below in the 6.1-channel mode.

4 Once "Meter" or "Feet" is selected in Step 3, the Delay Time screen appears automatically.

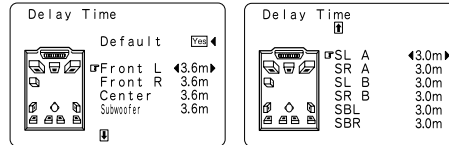

5 Select the speaker to be set.

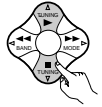

6 Set the distance between the center speaker and listening position. The distance changes in units of 0.1 meters (1 foot) each time the button is pressed. Select the value closest to the measured distance.

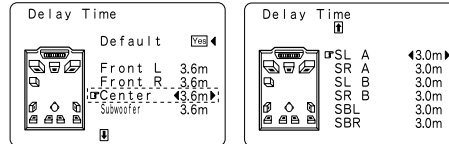

Example: When the distance is set to 3.6 m for the center speaker

※ If "Yes" is selected for "Default", the settings are automatically reset to the default values.

Please note that the difference of distance for every speaker should be 4.5 m (15 ft) or less. If you set an invalid distance, a CAUTION notice, such as screen right will appear. In this case, please relocate the blinking speaker(s) so that its distance is no larger than the value shown in highlighted line.

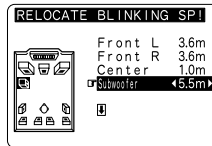

7 Enter the setting. The System Setup Menu reappears. The AVR-3802 automatically sets the optimum surround delay time for the listening room.

NOTES:

- If the distance unit is changed after the delay time is set, the settings are reset to the factory default values (see page 9).

Setting the channel level

- Use this setting to adjust so that the playback level between the different channels is equal.
- From the listening position, listen to the test tones produced from the speakers to adjust the level.
- The level can also be adjusted directly from the remote control unit. (For details, see page 27.)
- When using both surround speakers A and B, their playback levels can be adjusted separately.

1 At the System Setup Menu select "Channel Level".

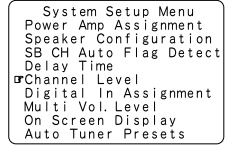
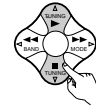

2 Switch to the Channel Level screen.

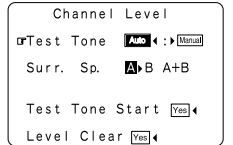

3 Select "Test Tone Mode".

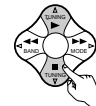

4 Select the mode. Select "Auto" or "Manual".

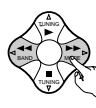

- Auto: Adjust the level while listening to the test tones produced automatically from the different speakers.
- Manual: Select the speaker from which you want to produce the test tone to adjust the level.

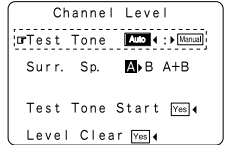

Example: When the "Auto" mode is selected

5 Select "Surr. Sp.", then select the surround speaker(s) from which you want to produce the test tone (A, B or A+B).

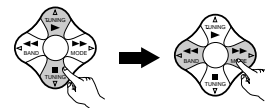

- Surr. Sp.: A Adjusts the balance of the playback level between the channels when using surround speaker A.
- Surr. Sp.: B Adjusts the balance of the playback level between the channels when using surround speaker B.
- Surr. Sp.: A+B Adjusts the balance of the playback level between the channels when using surround speakers A and B at the same time.

※ The "Surr. Sp." can only be selected when both surround speakers A and B have been selected at the "Speaker Configuration" (when both A and B have been set to "Large" or "Small").

6 Select "Test Tone Start".

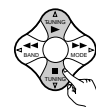

7



Select "Yes".



8

a. If the "Auto" mode is selected:
Test tones are automatically emitted from the different speakers.
The test tones are emitted from the different speakers in the following order, at 4-second intervals the first time and second time around, 2-second intervals the third time around and on:

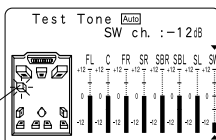

Flashing

Example: When the volume is set to -12 dB while the test tone is being produced from the subwoofer

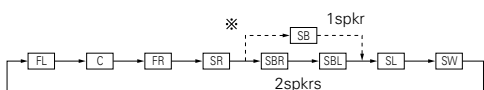

※ When the surround back speaker setting is set to "1spkr" for "Speaker Configuration", this is set to "SB".

Use the CURSOR buttons to adjust all the speakers to the same volume.
The volume can be adjusted between -12 dB and +12 dB in units of 1 dB.

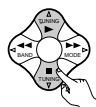

b. When the "Manual" mode is selected
Use the CURSOR left and right to select the speaker for which you want to output test tones, then use the CURSOR up and down to adjust so that the volume of the test tones from the various speakers is the same.

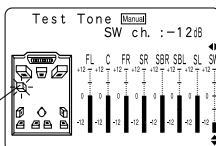

Flashing

Example: When the volume is set to -12 dB while the subwoofer is selected

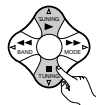

9



After the above settings are completed, press the ENTER button.
The "Channel Level" screen reappears.

※ To cancel the settings, select "Level Clear" and "Yes" on the "Channel Level" screen, then make the settings again.

The level of each channel should be adjusted to 75 dB (C-weighted, slow meter mode) on a sound level meter at the listening position.

If a sound level meter is not available adjust the channels by ear so the sound levels are the same. Because adjusting the subwoofer level test tone by ear is difficult, use a well known music selection and adjust for natural balance.

NOTE: When adjusting the level of an active subwoofer system, you may also need to adjust the subwoofer's own volume control.

- ※ When you adjust the channel levels while in the SYSTEM SETUP CHANNEL LEVEL mode, the channel level adjustments made will affect ALL surround modes. Consider this mode a Master Channel Level adjustment mode.
- ※ After you have completed the SYSTEM SETUP CHANNEL LEVEL adjustments, you can then activate the individual surround modes and adjust channel levels that will be remembered for each of those modes. Then, whenever you activate a particular surround sound mode, your preferred channel level adjustments for just that mode will be recalled. Check the instructions for adjusting channel levels within each surround mode on page 27.
- ※ You can adjust the channel levels for each of the following surround modes: DIRECT, STEREO, 5/7 CH STEREO, DOLBY/DTS SURROUND, WIDE SCREEN, ROCK ARENA, JAZZ CLUB, VIDEO GAME, MONO MOVIE, and MATRIX.
- ※ When using either surround speakers A or B, or when using surround speakers A and B at the same time, be sure to adjust the balance of playback levels between each channel for the various selections of "A or B" and "A and B".

Setting the Digital In Assignment

- This setting assigns the digital input jacks of the AVR-3802 for the different input sources.

1

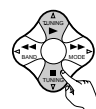

At the System Setup Menu select "Digital In Assignment".

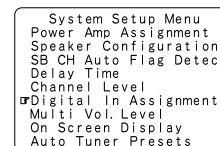

2



Switch to the Digital In Assignment screen.

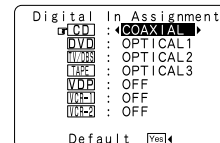

3

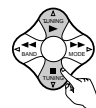

Select the digital input jack to be assigned to the input source.

- To select the input source
 - To select the digital input jack
- Select "OFF" for input sources for which no digital input jacks are used.

※ If "Yes" is selected for "Default", the settings are automatically reset to the default values.

4



Enter the setting.
The System Setup Menu reappears.

NOTES:

- The OPTICAL 3 jacks on the AVR-3802's rear panel are equipped with an optical digital output jack for recording digital signals on a CD recorder, MD recorder or other digital recorder. Use this for digital recording between a digital audio source (stereo - 2 channel) and a digital audio recorder.
- Do not connect the output of the component connected to the OPTICAL 3 OUT jack on the AVR-3802's rear panel to any jack other than the OPTICAL 3 IN jack.
- "PHONO" and "TUNER" cannot be selected on the Digital In Assignment screen.

Setting the multi vol. level

Set the multi pre-out output level adjustment.

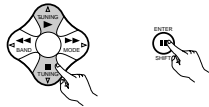
- 1**  At the "System Setup Menu" screen, select "Multi Vol. Level" and press the ENTER button.

System Setup Menu
 Power Amp Assignment
 Speaker Configuration
 SB CH Auto Flag Detect
 Delay Time
 Channel Level
 Digital In Assignment
 Multi Vol. Level
 On Screen Display
 Auto Tuner Presets

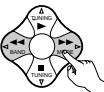
- 2**  Select the desired setting.

0 dB, -40 dB:
 The output level is fixed at the set level and the volume can no longer be adjusted.

Variable:
 The level can be adjusted freely using the buttons on the remote control unit.

Multi Vol. Level
 0dB ▶ -40dB Variable

- 3**  Enter the setting.
 The "System Setup Menu" reappears.

Setting the on-screen display (OSD)

• Use this to turn the on-screen display (messages other than the menu screens) on or off.

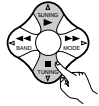
- 1**  At the System Setup Menu select "On Screen Display".

System Setup Menu
 Power Amp Assignment
 Speaker Configuration
 SB CH Auto Flag Detect
 Delay Time
 Channel Level
 Digital In Assignment
 Multi Vol. Level
 On Screen Display
 Auto Tuner Presets

- 2**  Switch to the On Screen Display screen.

On Screen Display
 ON : OFF

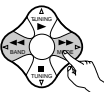
- 3**  Select "ON" or "OFF".

- 4**  Enter the setting.
 The System Setup Menu reappears.

Auto tuner preset

Use this to automatically search for FM broadcasts and store up to 40 stations at preset channels A1 to 8, B1 to 8, C1 to 8, D1 to 8 and E1 to 8.

NOTE:

- If an FM station cannot be preset automatically due to poor reception, use the "Manual tuning" operation to tune in the station, then preset it using the manual "Preset memory" operation.

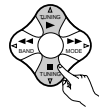
- 1**  Use the CURSOR buttons to specify "Auto Tuner Presets" from the "System Setup Menu" screen.

System Setup Menu
 Power Amp Assignment
 Speaker Configuration
 SB CH Auto Flag Detect
 Delay Time
 Channel Level
 Digital In Assignment
 Multi Vol. Level
 On Screen Display
 Auto Tuner Presets

- 2**  Press the ENTER button.
 The "Auto Preset Memory" screen appears.

Auto Preset Memory
 Auto Tuning &
 Preset Station Memory
 Storing Preset Memory
 Start Yes

- 3**  Use the CURSOR button to select "Yes".
 "Search" flashes on the screen and searching begins.
 "Completed" appears once searching is completed.
 The display automatically switches to screen.

※ This completes system setup. Once these settings are made, there is no need to change them unless different AV components are connected or the speakers are repositioned.

After completing system setup

This button can be pressed at any time during the system setup process to complete the process.



At the System Setup Menu, press the SYSTEM SETUP button.
 ※ The changed settings are entered and the on-screen display turns off.

On-screen display signals

	Signals input to the AVR-3802		On-screen display signal output	
	VIDEO signal input jack (yellow)	S-video signal input jack	VIDEO MONITOR OUT video signal output jack (yellow)	S-video MONITOR OUT video signal output jack
1	×	×	○	○
2	○	×	○	×
3	×	○	×	○
4	○	○	×	○

(○: Signal ×: No signal) (○: On-screen signals output ×: On-screen signals not output)

NOTES:

- The on-screen display signals are not output from the color difference (component) video signal MONITOR OUT jacks.
- For 4 above, the on-screen display signals are output to the VIDEO MONITOR OUT video signal output jack (yellow) if the monitor TV is not connected to the S-video MONITOR OUT video signal output jack.

8 REMOTE CONTROL UNIT

- The included remote control unit (RC-884) can be used to operate not only the AVR-3802 but other remote control compatible DENON components as well. In addition, the memory contains the control signals for other remote control units, so it can be used to operate non-Denon remote control compatible products.

Inserting the batteries

① Remove the remote control unit's rear cover.

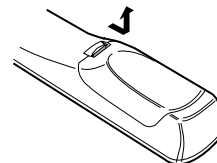

② Set three R6P/AA batteries in the battery compartment in the indicated direction.

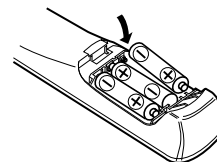

③ Put the rear cover back on.

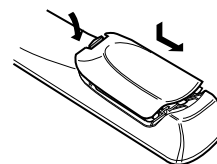

Notes on Batteries

- Use R6P/AA batteries in the remote control unit.
- The batteries should be replaced with new ones approximately once a year, though this depends on the frequency of usage.
- Even if less than a year has passed, replace the batteries with new ones if the set does not operate even when the remote control unit is operated nearby the set. (The included battery is only for verifying operation. Replace it with a new battery as soon as possible.)
- When inserting the batteries, be sure to do so in the proper direction, following the "⊕" and "⊖" marks in the battery compartment.
- To prevent damage or leakage of battery fluid:
 - Do not use a new battery together with an old one.
 - Do not use two different types of batteries.
 - Do not short-circuit, disassemble, heat or dispose of batteries in flames.
- Remove the batteries from the remote control unit when you do not plan to use it for an extended period of time.
- If the battery fluid should leak, carefully wipe the fluid off the inside of the battery compartment and insert new batteries.
- When replacing the batteries, have the new batteries ready and insert them as quickly as possible.

Using the remote control unit

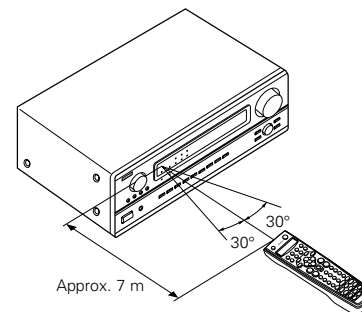

- Point the remote control unit at the remote sensor on the main unit as shown on the diagram.
- The remote control unit can be used from a straight distance of approximately 7 meters from the main unit, but this distance will be shorter if there are obstacles in the way or if the remote control unit is not pointed directly at the remote sensor.
- The remote control unit can be operated at a horizontal angle of up to 30 degrees with respect to the remote sensor.

NOTES:

- It may be difficult to operate the remote control unit if the remote sensor is exposed to direct sunlight or strong artificial light.
- Do not press buttons on the main unit and remote control unit simultaneously. Doing so may result in malfunction.
- Neon signs or other devices emitting pulse-type noise nearby may result in malfunction, so keep the set as far away from such devices as possible.

Operating DENON audio components

1 Use the mode selector buttons to select the component you want to operate.

※ The mode switches between "AMP", "TUNER" and "MULTI" each time the RECEIVER button is pressed, between "CDR", "MD" and "TAPE" each time the CDR/MD/TAPE button is pressed, between "DBS" and "CABLE" each time the DBS/CABLE button is pressed, and between "DVD" and "DVD SETUP" each time the DVD button is pressed, and between "VCR" and "VCR2" each time the VCR button is pressed.

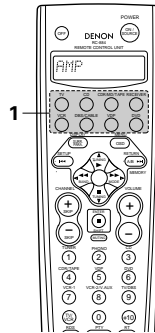

2 Operate the audio component.
 • For details, refer to the component's operating instructions.
 ※ It may not be possible to operate some models.

1. CD player (CD) system buttons

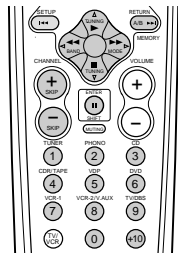

◀▶ : Manual search (forward and reverse)
 ■ : Stop
 ▶ : Play
 ◀▶▶ : Auto search (to beginning of track)
 || : Pause
 SKIP +, - : (for CD changers only)
 0-9, +10 : 10 key

2. Tape deck (TAPE) system buttons

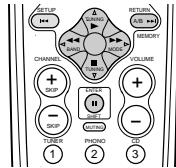

◀▶ : Rewind
 ▶▶▶ : Fast forward
 ■ : Stop
 ▶▶ : Forward play
 || : Pause
 ▶▶▶ : Reverse play
 A/B : Switch between sides A and B

3. MD recorder (MD), CD recorder (CDR) system buttons

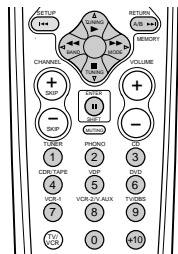

◀▶▶ : Manual search (forward and reverse)
 ■ : Stop
 ▶ : Play
 ◀▶▶ : Auto search (to beginning of track)
 || : Pause
 0-9, +10 : 10 key

4. Tuner system buttons

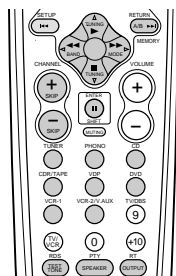

TUNING Δ, ∇ : Tuning up/down
 BAND : Switch between AM and FM bands
 MODE : Switch between AUTO and MONO
 MEMORY : Preset memory
 SHIFT : Switch preset channel range
 CHANNEL +, - : Preset channel up/down
 1-8 : 10 key
 RDS : RDS search
 PTY : PTY search
 RT : Radio Text

Preset memory

By using the preset memory, the included remote control unit can be used to control other makes of video equipment. Note that this is not possible for some models, however. In such cases, use the learning function (see page 19) to store the remote control signals in the remote control unit's memory. See page 20 for instructions on resetting the data stored in the preset memory.

1 Press the power ON/SOURCE button and the OFF button at the same time.

• "SET UP" appears on the remote control unit's display.



2 Press the ENTER button.



3 Use the Δ and ∇ cursor buttons to display "ENTER CODE" on the remote control unit, then press the ENTER button.

※ The remote control unit's display switches as follows each time the Δ and ∇ cursor buttons are pressed.

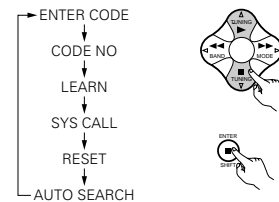

4 After "SEL MODE" is displayed, the last selected mode is set. Use the Δ and ∇ cursor buttons to display the component whose codes you want to store in the memory, then press the ENTER button.



※ The display switches as shown below each time the Δ and ∇ cursor buttons are pressed.

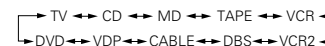

NOTES:

- The signals for the pressed buttons are emitted while setting the preset memory. To avoid accidental operation, cover the remote control unit's transmitting window while setting the preset memory.
- Depending on the model and year of manufacture, this function cannot be used for some models, even if they are of makes listed on the included list of preset codes.
- Some manufacturers use more than one type of remote control code. Refer to the included list of preset codes to change the number and check.

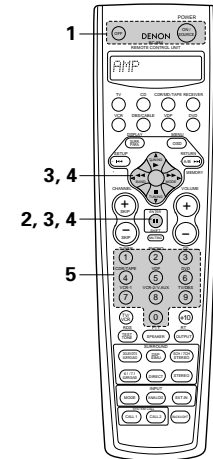

5 Referring to the included List of Preset Codes, use the number buttons to input the preset code (a 4-digit number) for the manufacturer of the component whose signals you want to store in the memory.

6 "OK" is displayed when the signals are registered and the mode is terminated.

7 To store the codes of another component in the memory, repeat steps 1 to 6.

The preset codes are as follows upon shipment from the factory and after resetting:
 TV, VCR.....HITACHI
 CD, MD, TAPE, CDR, VDP, DVD, DVD SETUPDENON
 DBSGENERAL INSTRUMENT
 CABLEJERROLD

Checking the preset memory settings

1 Press the power ON/SOURCE button and the OFF button at the same time.
 • "SET UP" appears on the remote control unit's display.



2 Press the ENTER button.



3 Use the Δ and ∇ cursor buttons to display "CODE NO" on the remote control unit, then press the ENTER button.



4 Press the Δ and ∇ cursor buttons to display the registered preset memory on the remote control unit's display and check.

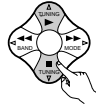

5 Press the ENTER button to terminate.



Operating a component stored in the preset memory

1 Press the mode selector button for the component you want to operate.

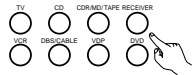

NOTE:
 • For the DVD player remote control buttons, function names may differ depending on the make. Compare with the remote control operation of the various components.

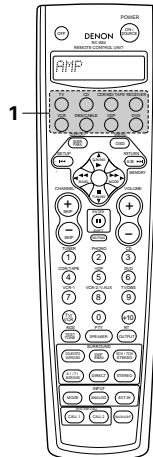

2 Operate the component.
 • For details, refer to the component's operating instructions.
 ※ Some models cannot be operated with this remote control unit.

1. Digital video disc player (DVD, DVD SETUP) system buttons

POWER : Power on/standby (ON/SOURCE)
 \lll \lll \ggg \ggg : Manual search (forward and reverse)
 \blacksquare : Stop
 \blacktriangleright : Play
 \lll \lll \ggg \ggg : Auto search (to beginning of track)
 \parallel : Pause
 0 ~ 9, +10 : 10 key
 skip +, - : Disc skip (for DVD changer only)
 DISPLAY : Display
 MENU : Menu
 RETURN : Return
 SETUP : Setup

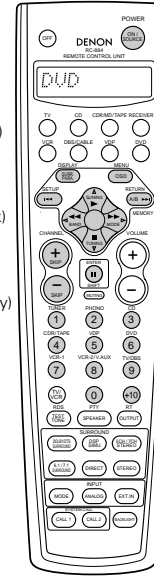

2. Video disc player (VDP) system buttons

POWER : Power on/standby (ON/SOURCE)
 \lll \lll \ggg \ggg : Manual search (forward and reverse)
 \blacksquare : Stop
 \blacktriangleright : Play
 \lll \lll \ggg \ggg : Auto search (cue)
 \parallel : Pause
 0~9, +10 : 10 key

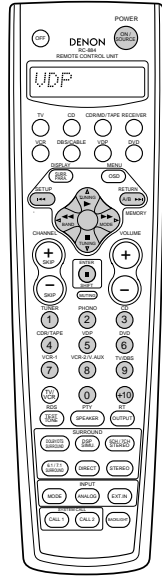

3. Video deck (VCR/VCR-2) system buttons

POWER : Power on/standby (ON/SOURCE)
 \lll \lll \ggg \ggg : Manual search (forward and reverse)
 \blacksquare : Stop
 \blacktriangleright : Play
 \parallel : Pause
 Channel +, - : Channels

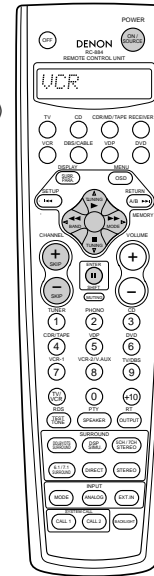

4. Monitor TV (TV), digital broadcast satellite (DBS) tuner and cable (CABLE) system buttons

POWER : Power on/standby (ON/SOURCE)
 SETUP : Setup
 RETURN : Menu
 Δ , ∇ , \triangleleft , \triangleright : Cursor up, down, left and right
 ENTER : Enter
 CHANNEL : Switch channels
 +, - : Channels
 0~9, +10 : Channels
 TV/VCR : Switch between TV and video player

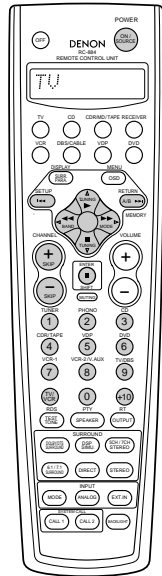

Learning function

If your AV component is not a Denon product or if it cannot be operated using the preset memory, it can be controlled with the included remote control unit by storing its remote control signals in the remote control unit.

- 1 Press the power ON/SOURCE button and the OFF button simultaneously.
 - "SET UP" appears on the remote control unit's display.



- 2 Press the ENTER button.



- 3 Use the Δ and ∇ cursor buttons to display "LEARN" on the remote control unit's display, then press the ENTER button.
 - "SEL MODE" is displayed.



- 4 Use the Δ and ∇ cursor buttons to select the mode for the button to be "learned", then press the ENTER button.
 - "SELECT KEY" is displayed.



- 5 Press the button to be "learned" while "SELECT KEY" is displayed. "NOW LEARN" appears.
 - "NOT VALID" is displayed if a button that cannot be "learned" is pressed.
 - To cancel, press the power ON/SOURCE button and the OFF button simultaneously.



- 6 Point the remote control units directly at each other and press and hold in the button on the other remote control unit which you want to "learn".

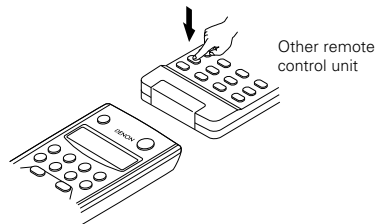

- 7 "COMPLETE" appears on the remote control unit's display and learning is completed.
 - "SELECT KEY" is displayed. Other keys can be "learned" by repeating steps 5 to 7.

- 8 To cancel the learning mode, press the power ON/SOURCE button and the OFF button simultaneously again. Registering is not possible in the receiver mode.

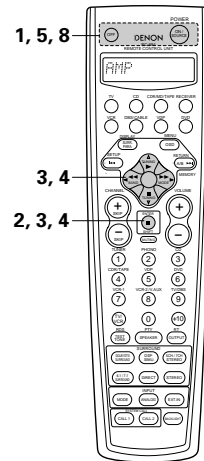

System call

The included remote control unit is equipped with a system call function allowing a series of remote control signals to be transmitted by pressing a single button. This function can be used for example to turn on the amplifier's power, select the input source, turn on the monitor TV's power, turn on the source component's power and set the source to the play mode, all at the touch of a button.

(1) System call buttons

The buttons that can be used for the system call function are shown on the diagram at the right. System call signals can be stored at different buttons according to the mode. System call signals can be stored at a maximum of 6 buttons other than the CALL 1 and CALL 2 buttons. 29 successive operations can be set at each of these buttons.

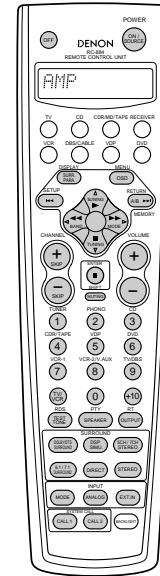

(2) Storing system call signals

- 1 Press the power ON/SOURCE button and the OFF button at the same time. "SET UP" appears on the remote control unit's display.

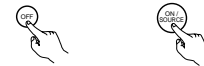

- 2 Press the ENTER button.



- 3 Use the Δ and ∇ cursor buttons to display "SYS CALL" on the remote control unit, then press the ENTER button.
 - Display "SYS MODE" on the remote control unit's display.

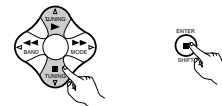

- 4 When "SYS MODE" is displayed, the remote control unit's display switches as shown below each time the Δ and ∇ cursor buttons are pressed.

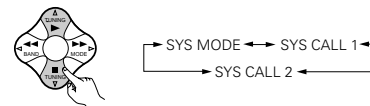

When "SYS CALL 1" or "SYS CALL 2" is selected, the signals are stored at the SYSTEM CALL 1 and CALL 2 buttons (green), regardless of the mode. When the enter button is pressed, the button registering mode (step 6) is set. To register at other buttons, select "SYS MODE" then press the enter button.

- After "SEL MODE" is displayed on the remote control unit's display, the mode last set is displayed.

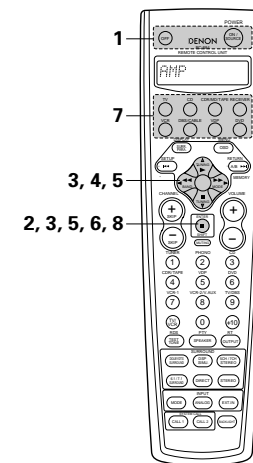

5 Use the Δ and ∇ cursor buttons to select the mode for the button at which the system call signals are to be registered, then press the ENTER button.



6 "SELECT KEY" is displayed. Press the button at which the system call signals are to be registered, then press the ENTER button.
 • "ENTER KEYS" is displayed, then the mode display appears.



NOTES:

- The remote control signals of the buttons pressed while registering the system call signals are emitted, so be careful not to operate the components accidentally (cover the remote sensors, for example).
- If you exceed the number of signals that can be registered, "FULL" appears on the remote control unit's display and only the number of signals that can be registered are registered (up to 29 operations).

(3) Using the system call function

1 Press the button at which the system call signals have been stored.
 • The stored signals are transmitted successively.

Resetting

(1) Resetting the system call buttons

1 Press the power ON/SOURCE button and the OFF button at the same time.
 • "SET UP" appears on the remote control unit's display.

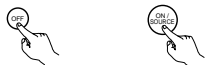

2 Press the ENTER button.



3 Use the Δ and ∇ cursor buttons to display "RESET" on the remote control unit, then press the ENTER button.



7 ① Press the mode selector button according to the button with the remote control signals to be registered.

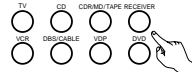

② Press the buttons with the remote control signals to be registered one at a time.

8 Press the ENTER button.
 • "COMPLETE" appears on the remote control unit's display and registration is completed.



4 Use the Δ and ∇ cursor buttons to display "RESET SYS" on the remote control unit, then press the ENTER button.
 • "SYS SEL" appears on the remote control unit's display.

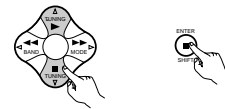

※ The remote control unit's display switches as shown below each time the Δ and ∇ cursor buttons are pressed.

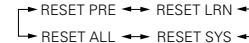

5 Press the Δ and ∇ cursor buttons to select the system call setting to be reset.

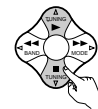

※ The remote control unit's display switches as shown below each time the Δ and ∇ cursor buttons are pressed.

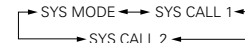

① To reset CALL 1 or CALL 2, select "SYS CALL 1" or "SYS CALL 2", then press the ENTER button.



② To reset system call settings registered at other buttons, select "SYS MODE", press the ENTER button, press the mode button at which the button is registered, then press the ENTER button again.



6 "CONFIRM" is displayed. To reset the setting, press the ENTER button while "CONFIRM" is displayed.
 • "SYS SEL" appears on the remote control unit's display.



(2) Resetting the preset memory

1 Press the power ON/SOURCE button and the OFF button at the same time.
 • "SET UP" appears on the remote control unit's display.



2 Press the ENTER button.



3 Use the Δ and ∇ cursor buttons to display "RESET" on the remote control unit, then press the ENTER button.

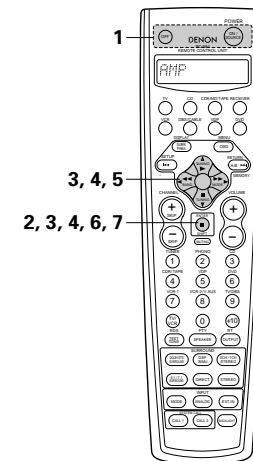
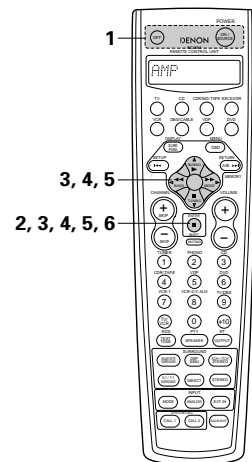
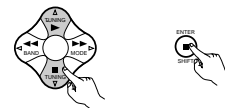

- 4** Use the Δ and ∇ cursor buttons to display "RESET PRE" on the remote control unit, then press the ENTER button.
- After "SEL PRE" is displayed on the remote control unit's display, the registered preset memory is displayed on the remote control unit's display.



- 5** Use the Δ and ∇ cursor buttons to select the code to be reset.

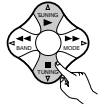

(3) Resetting "learned" buttons

- 1** Press the power ON/SOURCE button and the OFF button at the same time.
- "SET UP" appears on the remote control unit's display.



- 2** Press the ENTER button.



- 3** Use the Δ and ∇ cursor buttons to display "RESET" on the remote control unit's display, then press the ENTER button.
- "RESET PRE" is displayed.



- 4** Use the Δ and ∇ cursor buttons to display "RESET LRN" on the remote control unit's display, then press the ENTER button.
- "SEL MODE" is displayed, then "TV" appears.



- 6** When the mode you want to reset is shown on the remote control unit's display, press the ENTER button to reset the preset memory.



- 7** "CONFIRM" is displayed. To reset the preset memory, press the ENTER button while "CONFIRM" is displayed.
- "COMPLETE" appears on the remote control unit's display.

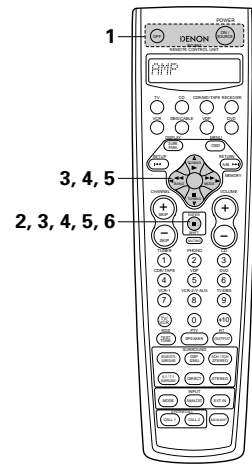

(4) All reset function

- This function is for resetting all the settings to the factory defaults.

- 1** Press the power ON/SOURCE button and the OFF button at the same time. "SET UP" appears on the remote control unit's display.



- 2** Press the ENTER button.



- 3** Use the Δ and ∇ cursor buttons to display "RESET" on the remote control unit, then press the ENTER button.



- 4** Use the Δ and ∇ cursor buttons to display "RESET ALL" on the remote control unit, then press the ENTER button.



- 5** "CONFIRM" is displayed. To reset, press the ENTER button while "CONFIRM" is displayed.
- "BUSY" is displayed during the resetting operation, and "COMPLETE" is displayed once resetting is completed.

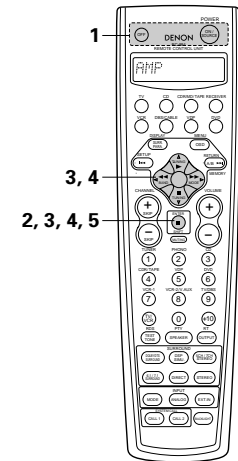

Auto search function

The set is equipped with a function for searching for the registration number if you do not know the preset code (a 4-digit number) when setting the preset memory.

1 For TV, DBS or CABLE components, turn on the component's power. For CD, MD, TAPE, DVD, VCR and VDP component's, turn on the component's power and load a disc or tape.

2 Press the power ON/SOURCE button and the OFF button simultaneously.

- "SET UP" appears on the remote control unit's display.



3 Press the ENTER button.



4 Use the Δ and ∇ cursor buttons to display "AUTOSEARCH" on the remote control unit, then press the ENTER button.



5 Use the Δ and ∇ cursor buttons to display the mode of the component to be searched for on the remote control unit's display, then press the ENTER button.

- The registration codes are transmitted in order.



6 When the component operates, press the POWER OFF button.

- The mode and the registered number appear on the remote control unit's display.

The channel switches on the TV, DBS or CABLE device and playback stops on a CD, MD, tape, DVD, VCR or VDP player.

7 Press the ENTER button.

- "COMPLETE" is displayed on the remote control unit's display and the selected code is preset.

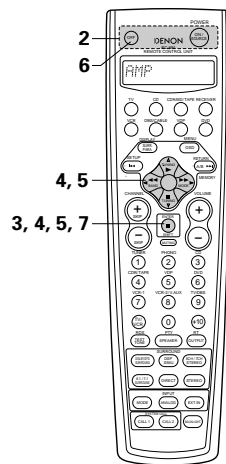

※ If you press the power OFF button late at step 6, press the Δ and ∇ cursor button once to move to the next code or back to the previous code one step at a time.

- Δ button: Next code
- ∇ button: Previous code

Auto search resumes when you move ahead from the code at which you stopped.

9 OPERATION

Before operating

1 Refer to "CONNECTIONS" (pages 4 to 8) and check that all connections are correct.

2 Select "AMP" using the RECEIVER button. (only when operating with the remote control unit)



(Remote control unit)

3 Turn on the power. Press the POWER operation switch (button).

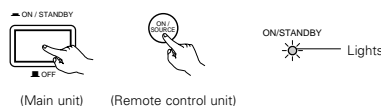

(Main unit) (Remote control unit)

- **ON/STANDBY**
The power turns on and "ON/STANDBY" indicator is light. Several seconds are required from the time the power operation switch is set to the "ON/STANDBY" position until sound is output. This is due to the built-in muting circuit that prevents noise when the power switch is turned on and off. Set the power operation switch to this position to turn the power on and off from the included remote control unit (RC-884).
- **OFF**
The power turns off and "ON/STANDBY" indicator is off. In this position, the power cannot be turned on and off from the remote control unit (RC-884).

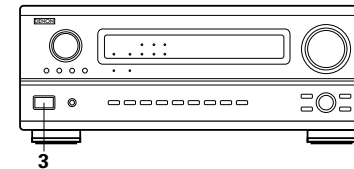

3

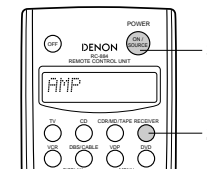

3

2

Playing the input source

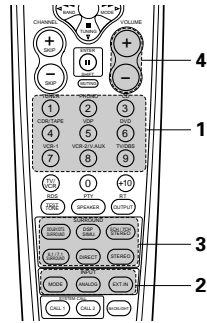
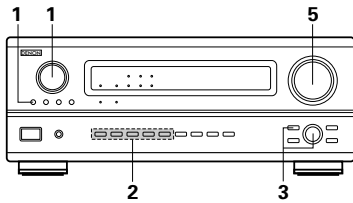

1 Select the input source to be played.

Example: CD

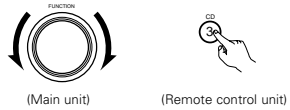

※ To select the input source when REC MULTI OUT or TUNING PRESET is selected, press the SOURCE button then operate the input function selector.

2 Select the input mode.

• Selecting the analog mode
Press the ANALOG button to switch to the analog input.

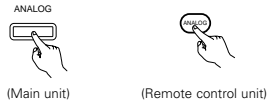

• Selecting the external input (EXT. IN) mode
Press the EXT. IN (on the EXT. IN button on the remote control unit) to switch the external input.



• Selecting the AUTO, PCM and DTS modes
The mode switches as shown below each time the INPUT MODE button is pressed.

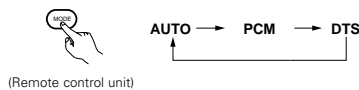

• Selecting the AUTO mode
Press the AUTO button to switch to the auto mode.



Input mode selection function

Different input modes can be selected for the different input sources. The selected input modes for the separate input sources are stored in the memory.

① AUTO (auto mode)

In this mode, the types of signals being input to the digital and analog input jacks for the selected input source are detected and the program in the AVR-3802's surround decoder is selected automatically upon playback. This mode can be selected for all input sources other than PHONO and TUNER.

The presence or absence of digital signals is detected, the signals input to the digital input jacks are identified and decoding and playback are performed automatically in DTS, Dolby Digital or PCM (2 channel stereo) format. If no digital signal is being input, the analog input jacks are selected.

Use this mode to play Dolby Digital signals.

② PCM (exclusive PCM signal playback mode)

Decoding and playback are only performed when PCM signals are being input.

Note that noise may be generated when using this mode to play signals other than PCM signals.

③ DTS (exclusive DTS signal playback mode)

Decoding and playback are only performed when DTS signals are being input.

④ ANALOG (exclusive analog audio signal playback mode)

The signals input to the analog input jacks are decoded and played.

⑤ EXT. IN (external decoder input jack selection mode)

The signals being input to the external decoder input jacks are played without passing through the surround circuitry.

NOTE:

• Note that noise will be output when CDs or LDs recorded in DTS format are played in the "PCM" (exclusive PCM signal playback) or "ANALOG" (exclusive PCM signal playback) mode. Select the AUTO or DTS mode when playing signals recorded in DTS from a laser disc player or CD player.

Note on playing a source encoded with DTS

• Noise may be generated at the beginning of playback and while searching during DTS playback in the AUTO mode. If so, play in the DTS mode.

• Selecting the PCM mode
Press the PCM button to switch to the PCM signal input.



• Selecting the DTS mode
Press the DTS button to switch to the DTS signal input.



3 Select the play mode.

Example: Stereo

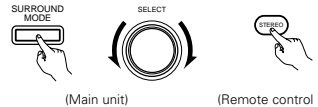

※ To select the surround mode while adjusting the surround parameters, channel volume or tone control, press the surround mode button then operate the selector.

4 Start playback on the selected component.

• For operating instructions, refer to the component's manual.

5 Adjust the volume.

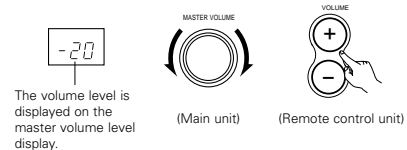

※ The volume can be adjusted within the range of -70 to 0 to 18 dB, in steps of 1 dB. However, when the channel level is set as described on page 13 or page 27, if the volume for any channel is set at +1 dB or greater, the volume cannot be adjusted up to 18 dB. (In this case the maximum volume adjustment range is "18 dB — (Maximum value of channel level)".)

Input mode when playing DTS sources

• Noise will be output if DTS-compatible CDs or LDs are played in the "ANALOG" or "PCM" mode. When playing DTS-compatible sources, be sure to connect the source component to the digital input jacks (OPTICAL/COAXIAL) and set the input mode to "DTS".

Input mode display

- In the AUTO mode
- In the DIGITAL PCM mode
- In the DIGITAL DTS mode
- In the ANALOG mode

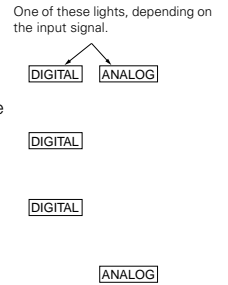

Input signal display

- DOLBY DIGITAL
- DTS
- PCM

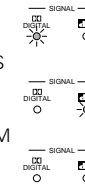

※ The DIGITAL indicator lights when digital signals are being input properly. If the DIGITAL indicator does not light, check whether the digital input component setup (page 14) and connections are correct and whether the component's power is turned on.

NOTE:

• The DIGITAL indicator will light when playing CD-ROMs containing data other than audio signals, but no sound will be heard.

Playback using the external input (EXT. IN) jacks

- 1** Set the external input (EXT. IN) mode.
Press the EXT. IN to switch the external input.



Once this is selected, the input signals connected to the FL (front left), FR (front right), C (center), SL (surround left), SR (surround right), SBL (surround back left) and SBR (surround back right) channels of the EXT. IN jacks are output directly to the front (left and right), center, surround (left and right) and surround back (left and right) speaker systems as well as the pre-out jacks without passing through the surround circuitry.
In addition, the signal input to the SW (subwoofer) jack is output to the PRE OUT SUBWOOFER jack.

- 2** Cancelling the external input mode
To cancel the external input (EXT. IN) setting, press the input mode (AUTO, PCM, DTS) or ANALOG button to switch to the desired input mode. (See page 23.)

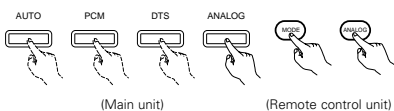

- When the input mode is set to the external input (EXT. IN), the play mode (DIRECT, STEREO, DOLBY/DTS SURROUND, 5/7CH STEREO, WIDE SCREEN or DSP SIMULATION) cannot be set.

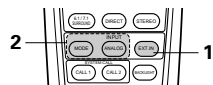
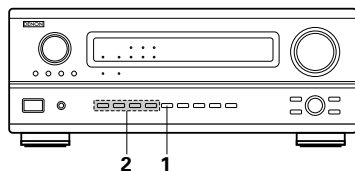

NOTES:

- In play modes other than the external input mode, the signals connected to these jacks cannot be played. In addition, signals cannot be output from channels not connected to the input jacks.
- The external input mode can be set for any input source. To watch video while listening to sound, select the input source to which the video signal is connected, then set this mode.

After starting playback

- [1] Adjusting the sound quality (TONE)**
The tone control function will not work in the Direct mode.

- 1** The tone switches as follows each time the TONE CONTROL button is pressed.

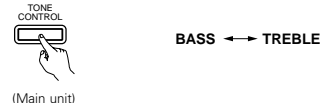

- 2** With the name of the volume to be adjusted selected, turn the SELECT knob to adjust the level.

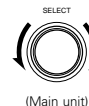

- To increase the bass or treble: Turn the control clockwise. (The bass or treble sound can be increased to up to +12 dB in steps of 2 dB.)
- To decrease the bass or treble: Turn the control clockwise. (The bass or treble sound can be decreased to up to -12 dB in steps of 2 dB.)

[2] Listening over headphones

- 1** Connect the headphones to the PHONES jack of the front panel.



- 2** Press the OUTPUT button to play the sound over the headphones only.



- The output to the speaker and pre-out jacks is turned off and no sound is produced from the speakers.

※ **Caution:** Switching off the power of the unit and the unit will cancel the settings.

[3] Turning the sound off temporarily (MUTING)

- 1** Use this to turn off the audio output temporarily.
Press the MUTING button.
※ Cancelling MUTING mode.
Press the MUTING button again.

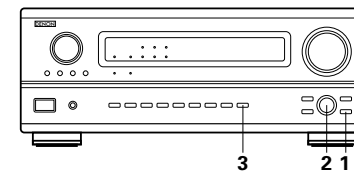
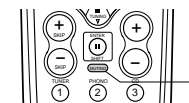

- 3** If you do not want the bass and treble to be adjusted, turn on the tone defeat mode.



※ The signals do not pass through the bass and treble adjustment circuits, providing higher quality sound.

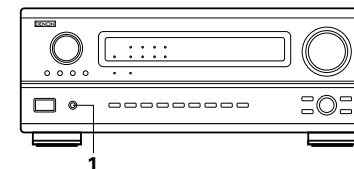

NOTE:
To prevent hearing loss, do not raise the volume level excessively when using headphones.

[4] Combining the currently playing sound with the desired image

1 Simulcast playback
Use this switch to monitor a video source other than the audio source.
Press the VIDEO SELECT button repeatedly until the desired source appears on the display.

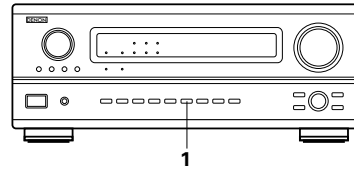

- ※ Cancelling simulcast playback.
- Select "SOURCE" using the VIDEO SELECT button.
 - Switch the program source to the component connected to the video input.

[5] Checking the currently playing program source, etc.

1 On screen display
• Each time an operation is performed, a description of that operation appears on the unit's VIDEO MONITOR OUT jack.

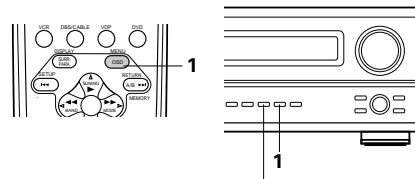

Also, the unit's operating status can be checked during playback by pressing the remote control unit's OSD button.
Such information as the position of the input selector and the surround parameter settings is output in sequence.

Using the dimmer function
• Use this to change the brightness of the display.



The display brightness changes in four steps (bright, medium, dim and off) by pressing the remote control unit's DIMMER button repeatedly.

- ※ The brightness changes in 3 steps each time the button is pressed, and finally the display turns off.

Front panel display
• Descriptions of the unit's operations are also displayed on the front panel display.
In addition, the display can be switched to check the unit's operating status while playing a source by pressing the STATUS button.



Multi-source recording/playback

[1] Playing one source while recording another (REC OUT mode)

1 Press the REC/MULTI button.



2 With "RECOUT SOURCE" displayed, turn the FUNCTION knob to select the source you wish to record.
• The "REC" indicator and the indicator of the selected source light.

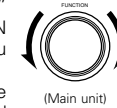

3 Set the recording mode.
• For operating instructions, refer to the manual of the component on which you want to record.

4 To cancel, turn the function knob and select "SOURCE".
• When "SOURCE" is selected, the "REC" indicator turns off.

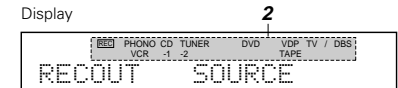
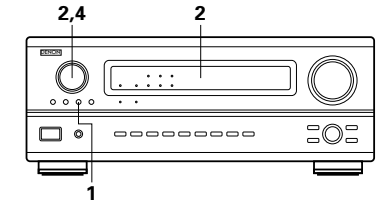
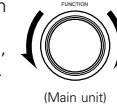

- NOTES:**
- Recording sources other than digital inputs selected in the REC OUT mode are also output to the multi source audio output jacks.
 - Digital signals are not output from the REC SOURCE or audio output jacks.

[2] Outputting a program source to an amplifier, etc., in a different room (MULTI mode)

1 Press the REC/MULTI button.
The display switches as follows each time the button is pressed.



2 With "M-SOURCE SOURCE" displayed, turn the FUNCTION knob and select the source you wish to output.
• The "MULTI" indicator and the indicator of the selected source light.

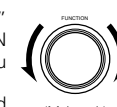

3 Start playing the source to be output.
• For operating instructions, refer to the manuals of the respective components.

4 To cancel, turn the function knob and select "SOURCE".
• When "SOURCE" is selected, the "MULTI" indicator turns off.

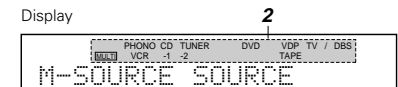
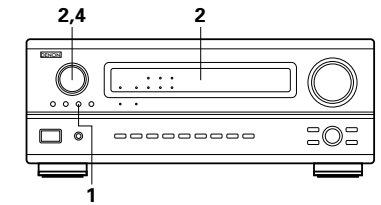
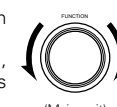

- NOTES:**
- The signals of the source selected in the MULTI mode are also output from the VCR-1, VCR-2/V.AUX and CDR/TAPE recording output terminals.
 - Digital signals are not output from the multi source audio output jacks.

[3] Remote control unit operations during multi-source playback (selecting the input source)

This operation is possible when Multi mode is selected.
This operation is not possible in the REC OUT mode.

- 1 Select "MULTI" using the RECEIVER button.  (Remote Control unit)

- 2 Press the input source button. **Example: CD**  (Remote Control unit)

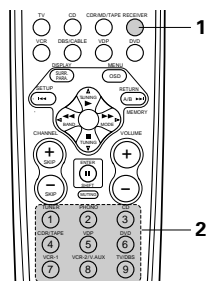

[4] Remote control unit operation during multi-source playback (adjusting the volume level)

- 1 Select "MULTI" using the RECEIVER button.  (Remote Control unit)

- 2 Use the VOLUME buttons to adjust the volume level.  (Remote Control unit)

NOTE:
MULTI VOLUME functions when "Variable" is selected for SYSTEM SETUP MENU "Multi Vol. Level". (See page 15.)

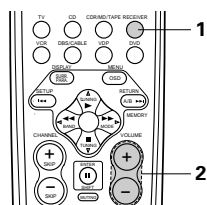

Multi-source and multi-zone playback

MULTI ZONE MUSIC ENTERTAINMENT SYSTEM

- When the outputs of the MULTI ZONE PRE OUT terminals are wired and connected to integrated amplifiers installed in other rooms, different sources can be played in rooms other than the main room in which this unit and the playback devices are installed. (Refer to ANOTHER ROOM on the diagram below.)
- MULTI ZONE SPEAKER OUT can be used when "Multi" is selected at System Setup Menu "Power Amp Assignment". In this case, Surround Back Speaker OUT cannot be used for MAIN ROOM. (See page 10.)

NOTE:

- For the AUDIO output, use high quality pin-plug cords and wire in such a way that there is no humming or noise.

■ MULTI ZONE MUSIC ENTERTAINMENT SYSTEM (When using PREOUT)

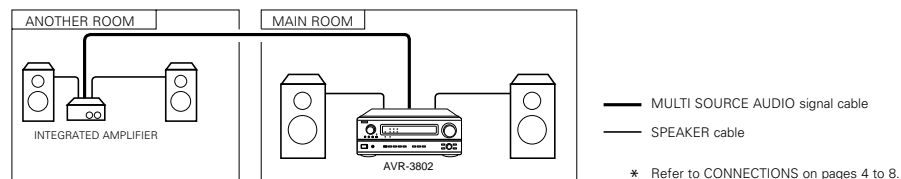

■ MULTI ZONE MUSIC ENTERTAINMENT SYSTEM (When using SPEAKER OUT)

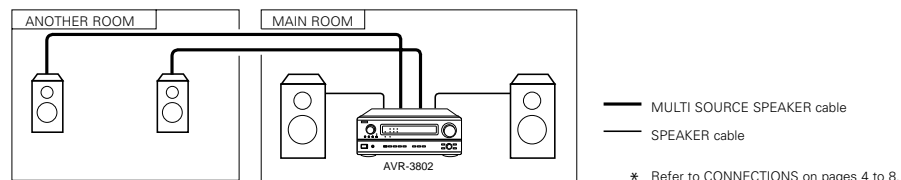

10 SURROUND

Before playing with the surround function

- Before playing with the surround function, be sure to use the test tones to adjust the playback level from the different speakers. This adjustment can be performed with the system setup (see page 13) or from the remote control unit, as described below.
- Adjusting with the remote control unit using the test tones is only possible in the "Auto" mode and only effective in the DOLBY/DTS SURROUND modes. The adjusted levels for the different modes are automatically stored in the memory.

- 

Press the TEST TONE button.

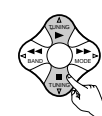
(Remote control unit)
- 

Test tones are output from the different speakers. Use the channel volume adjust buttons to adjust so that the volume of the test tones is the same for all the speakers.

(Remote control unit)
- 

After completing the adjustment, press the TEST TONE button again.

(Remote control unit)

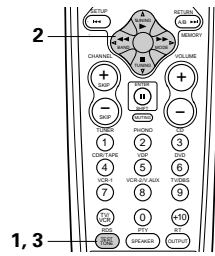

- After adjusting using the test tones, adjust the channel levels either according to the playback sources or to suit your tastes, as described below.

- Select the speaker whose level you want to adjust.



(Main unit) (Remote control unit)

The channel switches as shown below each time the button is pressed.

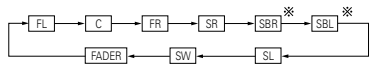
- Adjust the level of the selected speaker.

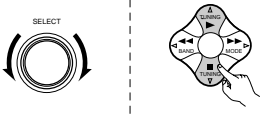

(Main unit) (Remote control unit)

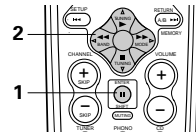
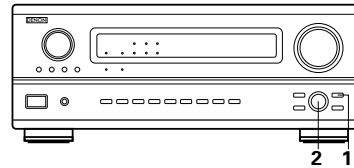

NOTES:

- The adjustment range for the different channels is +12 dB to -12 dB.
- When using the DIRECT mode, the sound from the subwoofer can be cut by lowering the SW (subwoofer) setting one step from -12 dB (setting it to "OFF").

※ When the surround back speaker setting is set to "1spkr" for "Speaker Configuration", this is set to "SB".

Fader function

- This function makes it possible to lower the volume of the front channels (FL, C and FR) or the rear channels (SL, SR, SBL and SBR) together. Use it for example to adjust the balance of the sound from the different positions when playing multi-channel music sources.

- Select "FADER".



(Main unit) (Remote control unit)

The channel switches in the order shown below each time this button is pressed.

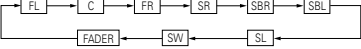
- Press the Δ button to reduce the volume of the front channels, the ∇ button to reduce the volume of the rear channels.

※ The fader function does not affect the SW channel.

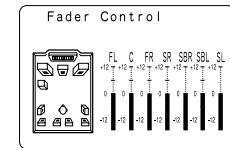
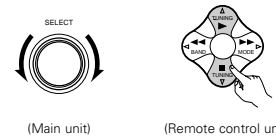
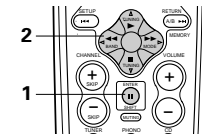
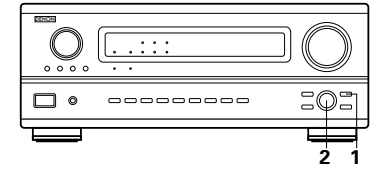

This is only displayed when setting the fader control.



- ※ The channel whose channel level is adjusted lowest can be faded to -12 dB using the fader function.
- ※ If the channel levels are adjusted separately after adjusting the fader, the fader adjustment values are cleared, so adjust the fader again.

Dolby Surround Pro Logic II mode

- Select the Dolby Surround Pro Logic II mode.

 - The Dolby Pro Logic indicator lights.

(Main unit) (Remote control unit)

- Play a program source with the  mark.

 - For operating instructions, refer to the manuals of the respective components.

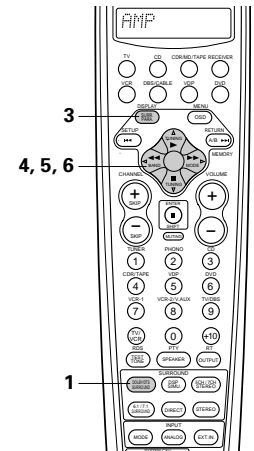
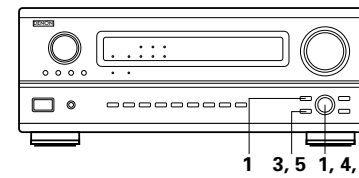

3 Set the surround parameter mode.

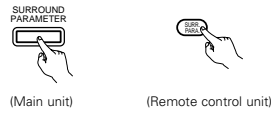

Display

MODE CINEMA

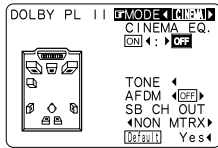

※ The on-screen display differs according to whether the operation is performed from the main unit or the remote control unit.

4 Select the play mode.

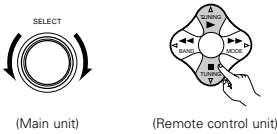

Display

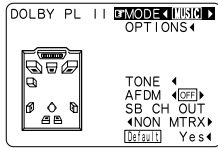
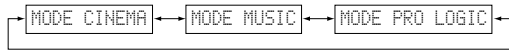

5 Select the various parameters. (See "Surround parameters ①" for a description of the various parameters.)

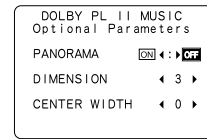
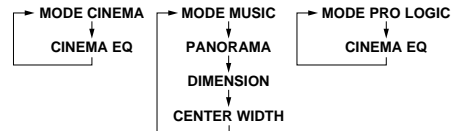
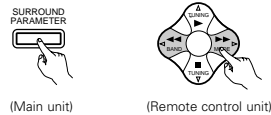

※ When set with the on-screen display using the remote control unit while in the MUSIC mode, set the "OPTION" mark to "OPTION" using the Δ and ∇ cursor buttons, then press the \blacktriangleleft cursor button. Press the ENTER button to return to the previous screen.

6 Set the various surround parameters.

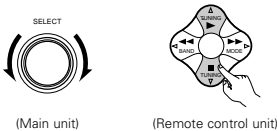

7 When the surround parameters are set using the buttons on the main unit, stop operating buttons after completing the settings. The settings are automatically finalized and the normal display reappears after several seconds.

When the settings are made using the buttons on the remote control unit, press the SURR. PARA. button to finish.

NOTE:

- There are four Dolby Surround Pro Logic modes (NORMAL, PHANTOM, WIDE and 3 STEREO). The AVR-3802 sets the mode automatically according to the types of speakers set during the system setup process (page 10).

Surround parameters ①

Pro Logic II Mode:

The Cinema mode is for use with stereo television shows and all programs encoded in Dolby Surround. The Music mode is recommended as the standard mode for autosound music systems (no video), and is optional for A/V systems. The Pro Logic mode offers the same robust surround processing as original Pro Logic in case the source contents is not of optimum quality. Select one of the modes ("Cinema", "Music" or "Pro Logic").

Panorama Control:

This mode extends the front stereo image to include the surround speakers for an exciting "wraparound" effect with side wall imaging. Select "OFF" or "ON".

Dimension Control:

This control gradually adjust the soundfield either towards the front or towards the rear. The control can be set in 7 steps from 0 to 6.

Center Width Control:

This control adjust the center image so it may be heard only from the center speaker; only from the left/right speakers as a phantom image; or from all three front speakers to varying degrees. The control can be set in 8 steps from 0 to 7.

Dolby Digital mode (only with digital input) and DTS Surround mode (only with digital input)

1 Select the input source.

Playback with digital input

① Select an input source set to digital (COAXIAL/OPTICAL) (see page 14).

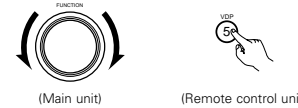

② Set the input mode to "AUTO" or "DTS".

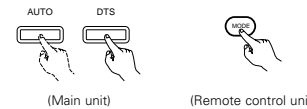

2 Select the Dolby/DTS Surround mode.

(Remote control unit)

When performing this operation from the main unit's panel, press the SURROUND MODE button, then turn the SELECT knob and select Dolby Pro logic or DTS NEO:6.

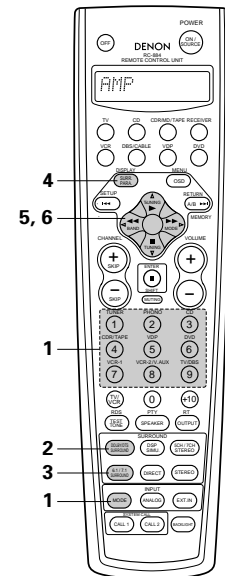
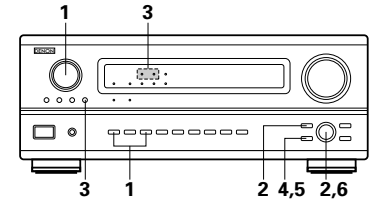

3 Play a program source with the **DOLBY DIGITAL**, **mark**.

- Light • The Dolby Digital indicator lights when playing Dolby Digital sources.
- Light • The DTS indicator lights when playing DTS sources.
- Light • The SIGNAL DETECT indicator lights when playing DTS-ES/6.1-channel surround sources containing the identification signal.

※ When the SIGNAL DETECT indicator is lit, we recommend turning the surround back channel using the 6.1/7.1 Surround button on the remote control unit and main unit during playback.

Operate the 6.1/7.1 Surround button to switch Surround Back CH ON/OFF.



- Light • Lights when the 6.1/7.1 Surround mode is on.

4 Display the surround parameter menu.

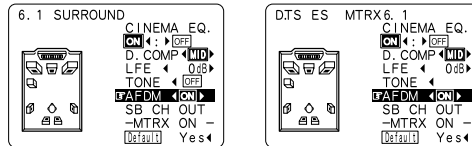

NOTE: The display on the screen differs depending on whether you are performing the operation from the main unit or the remote control unit.

5 Select the various parameters.

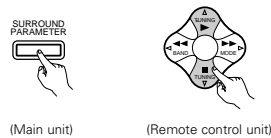

6 Adjust the parameter settings.

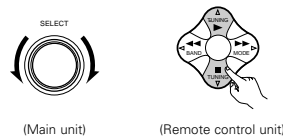

■ Dialogue Normalization

The dialogue normalization function is activated automatically when playing Dolby Digital program sources. Dialogue normalization is a basic function of Dolby Digital which automatically normalizes the dialog level (standard level) of the signals which are recorded at different levels for different program sources, such as DVD, DTV and other future formats that will use Dolby Digital. These contents can be verified with the STATUS button.



The number indicates the normalization level when the currently playing program is normalized to the standard level.

NOTE: When "Default" is selected and the cursor button is pressed, "CINEMA EQ." and "D.COMP." are automatically turned off, "LFE" is reset, and the tone is set to the default value.

Surround parameters ②

CINEMA EQ. (Cinema Equalizer):

The Cinema EQ function gently decreases the level of the extreme high frequencies, compensating for overly-bright sounding motion picture soundtracks. Select this function if the sound from the front speakers is too bright.

This function only works in the Dolby Pro Logic, Dolby Digital, DTS Surround and WIDE SCREEN modes. (The same contents are set for all operating modes.)

D.COMP. (Dynamic Range Compression):

Motion picture soundtracks have tremendous dynamic range (the contrast between very soft and very loud sounds). For listening late at night, or whenever the maximum sound level is lower than usual, the Dynamic Range Compression allows you to hear all of the sounds in the soundtrack (but with reduced dynamic range). (This only works when playing program sources recorded in Dolby Digital or DTS.) Select one of the four parameters ("OFF", "LOW", "MID" (middle) or "HI" (high)). Set to OFF for normal listening.

LFE (Low Frequency Effect):

This sets the level of the LFE (Low Frequency Effect) sounds included in the source when playing program sources recorded in Dolby Digital or DTS.

If the sound produced from the subwoofer sounds distorted due to the LFE signals when playing Dolby Digital or DTS sources when the peak limiter is turned off with the subwoofer peak limit level setting (system setup menu), adjust the level as necessary.

Program source and adjustment range:

- Dolby Digital: -10 dB to 0 dB
- DTS Surround: -10 dB to 0 dB

※ When DTS encoded movie software is played, it is recommended that the LFE LEVEL be set to 0 dB for correct DTS playback.

※ When DTS encoded music software is played, it is recommended that the LFE LEVEL be set to -10 dB for correct DTS playback.

TONE:

This adjusts the tone control. (See "Surround parameters ③" on page 32.)

AFDM (Auto Flag Detect Mode):

Turns the auto flag detect mode on and off.

For 5-channel Dolby Digital/DTS sources:

The surround back channel play mode can be selected when the **AFDM** (Auto Flag Detect Mode) is set to "OFF". The parameters that can be selected are the same as the "Non-Flag Source SBch Output" settings.

When the **AFDM** (Auto Flag Detect Mode) is set to "ON", the setting selected at "Non-Flag Source SBch Output" are displayed. (See page 12.)

If you wish to change the setting, set the AFDM (Auto Flag Detect Mode) to "OFF".

SB CH OUT (6.1/7.1 Surround):

(1) Dolby Digital/DTS source

"OFF"Playback is conducted without using the surround back speaker.

"NON MTRX"Playback is conducted using the surround back speaker.

The same signals those of the surround channels are output from the surround back channels.

"MTRX ON"Playback is conducted using the surround back speaker.

Surround back channel is reproduced using digital matrix processing.

(2) Other source

"OFF"Playback is conducted without using the surround back speaker.

"ON"Playback is conducted using the surround back speaker.

NOTE: This operation can be performed directly using the "6.1/7.1 Surround" button on the main unit's panel.

11 DSP SURROUND SIMULATION

- The AVR-3802 is equipped with a high performance DSP (Digital Signal Processor) which uses digital signal processing to synthetically recreate the sound field. One of seven preset surround modes can be selected according to the program source and the parameters can be adjusted according to the conditions in the listening room to achieve a more realistic, powerful sound. These surround modes can also be used for program sources not recorded in Dolby Surround Pro Logic or Dolby Digital.

DSP surround simulation

- To operate the surround mode and surround parameters from the remote control unit.

1 Select the surround mode for the input channel.

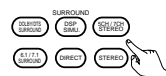

(Remote control unit)

The surround mode switches in the following order each time the DSP SIMULATION button is pressed:

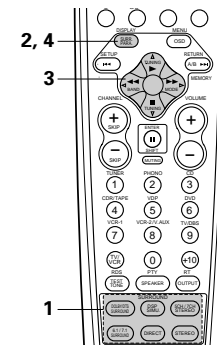

2 Display the surround parameter screen on the monitor.
 ※ The screen for the selected surround mode appears.



(Remote control unit)

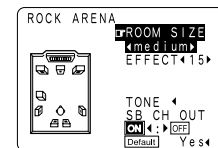

3 Set the parameters.



(Remote control unit)

4 To end the setting mode, press the surround parameter button again.



(Remote control unit)

Surround modes and their features

1	WIDE SCREEN	Select this to achieve an atmosphere like that of a movie theater with a large screen. In this mode, all signal sources are played in the 7.1-channel mode, including Dolby Pro Logic and Dolby Digital 5.1-channel sources. Effects simulating the multi surround speakers of movie theaters are added to the surround channels.
2	ROCK ARENA	Use this mode to achieve the feeling of a live concert in an arena with reflected sounds coming from all directions.
3	JAZZ CLUB	This mode creates the sound field of a live house with a low ceiling and hard walls. This mode gives jazz a very vivid realism.
4	VIDEO GAME	Use this to enjoy video game sources.
5	MATRIX	Select this to emphasize the sense of expansion for music sources recorded in stereo. Signals consisting of the difference component of the input signals (the component that provides the sense of expansion) processed for delay are output from the surround channel.
6	MONO MOVIE (NOTE 1)	Select this when watching monaural movies for a greater sense of expansion.
7	5CH/7CH STEREO	In this mode, the signals of the front left channel are output from the left surround channel, the signals of the front right channel are output from the right surround channel, and the same (in-phase) component of the left and right channels is output from the center channel. This mode provides all speaker surround sound, but without directional steering effects, and works with any stereo program source.

※ Depending on the program source being played, the effect may not be very noticeable. In this case, try other surround modes, without worrying about their names, to create a sound field suited to your tastes.

NOTE 1: When playing sources recorded in monaural, the sound will be one-sided if signals are only input to one channel (left or right), so input signals to both channels. If you have a source component with only one audio output (monophonic camcorder, etc.) obtain a "Y" adaptor cable to split the mono output to two outputs, and connect to the L and R inputs.

NOTES:

- The surround speaker setting can also be changed with the SPEAKER button on the remote control unit.
- When "Default" is selected and the < cursor button is pressed, "CINEMA EQ." and "D.COMP." are automatically turned off, "ROOM SIZE" is set to "medium", "EFFECT LEVEL" to "10", "DELAY TIME" to "30ms" and "LFE" to "0 dB".
- The "ROOM SIZE" expresses the expansion effect for the different surround modes in terms of the size of the sound field, not the actual size of the listening room.

NOTE:
 Only the DIRECT and 5CH/7CH STEREO modes can be used when playing PCM signals with a sampling frequency of 96 kHz (such as from DVD-Video discs that contain 24 bit, 96 kHz audio). If such signals are input during playback in one of the other surround modes, the mode automatically switches to DIRECT.

Personal Memory Plus
 This set is equipped with a personal memorize function that automatically memorizes the surround modes and input modes selected for the input different sources. When the input source is switched, the modes set for that source last time it was used are automatically recalled.
 ※ The surround parameters, tone control settings and playback level balance for the different output channels are memorized for each surround mode.

- Operating the surround mode and surround parameters from the main unit's panel.

1 Turn the SELECT knob to select the surround mode.

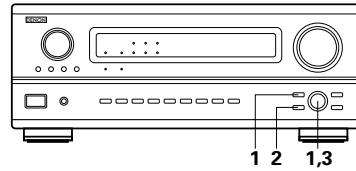
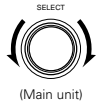

- When turned clockwise

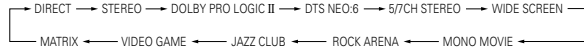

- When turned counterclockwise

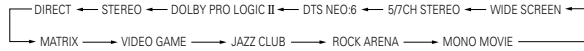

- ※ To select the surround mode while adjusting the surround parameters, channel volume or tone control, press the surround mode button then operate the selector.

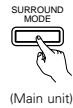

2 Press the SURROUND PARAMETER button.



- Press and hold in the surround parameter button to select the parameter you want to set.
- The parameters which can be set differ for the different surround modes. (Refer to "Surround Modes and Parameters" on page 32.)

3 Display the parameter you want to adjust, then turn the SELECT knob to set it.

NOTE:

- When playing PCM digital signals or analog signals in the DOLBY PRO LOGIC, DTS NEO:6 modes and the input signal switches to a digital signal encoded in Dolby Digital, the Dolby surround mode switches automatically. When the input signal switches to a DTS signal, the mode automatically switches to DTS surround.

Tone control setting

- Use the tone control setting to adjust the bass and treble as desired.
- To operate the tone control from the remote control unit.

1 (Remote control unit)

Display the surround parameter screen on the monitor.
 ※ The screen for the selected surround mode appears. "TONE" cannot be selected in the Direct mode.

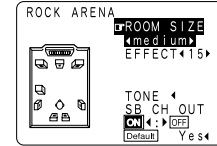

2 (Remote control unit)

Select "TONE".

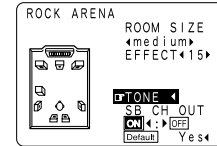

3 (Remote control unit)

Switch to the Tone Control screen.



4 (Remote control unit)

To select Bass or Treble.

To set the level.

5 (Remote control unit)

Enter the setting. The surround menu screen re-appears.

6 (Remote control unit)

To end the setting mode, press the surround parameter button again.

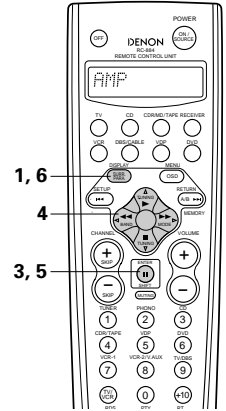

- To operate the tone control from the main unit.

1 (Main unit)

The tone switches as follows each time the TONE CONTROL button is pressed.



2 (Main unit)

- With the name of the volume to be adjusted selected, turn the SELECT knob to adjust the level.
- To increase the bass or treble: Turn the control clockwise. (The bass or treble sound can be increased up to +12 dB in steps of 2 dB.)
 - To decrease the bass or treble: Turn the control counterclockwise. (The bass or treble sound can be decreased up to -12 dB in steps of 2 dB.)

Surround parameters ③

MODE: (DTS NEO:6)

• **Cinema**

This mode is optimum for playing movies. Decoding is performed with emphasis on separation performance to achieve the same atmosphere with 2-channel sources as with 6.1-channel sources. This mode is effective for playing sources recorded in conventional surround formats as well, because the in-phase component is assigned mainly to the center channel (C) and the reversed phase component to the surround (SL, SR and SB channels).

• **Music**

This mode is suited mainly for playing music. The front channel (FL and FR) signals bypass the decoder and are played directly so there is no loss of sound quality, and the effect of the surround signals output from the center (C) and surround (SL, SR and SB) channels add a natural sense of expansion to the sound field.

ROOM SIZE:

This sets the size of the sound field. There are five settings: "small", "med.s" (medium-small), "medium", "med.l" (medium-large) and "large". "small" recreates a small sound field, "large" a large sound field.

EFFECT LEVEL:

This sets the strength of the surround effect. The level can be set in 15 steps from 1 to 15. Lower the level if the sound seems distorted.

DELAY TIME:

In the matrix mode only, the delay time can be set within the range of 0 to 300 ms.

TONE CONTROL:

This can be set individually for the separate surround modes other than Direct. However, the same contents are set for DOLBY/DTS modes.

■ **Surround modes and parameters**

Mode	Channel output					When playing Dolby Digital Signals	When playing DTS signals	When playing PCM signals	When playing ANALOG signals
	Front L/R	CENTER	SURROUND L/R	SUB-WOOFER	SURROUND BACK L/R				
DIRECT	○	×	×	⊗	×	○	○	○	○
STEREO	○	×	×	⊗	×	○	○	○	○
EXTERNAL INPUT	○	⊗	⊗	⊗	⊗	×	×	×	○
DOLBY PRO LOGIC II	○	⊗	⊗	⊗	⊗	* ○	×	○	○
DTS NEO:6	○	⊗	⊗	⊗	⊗	×	×	○	○
DOLBY DIGITAL (6.1 SURROUND)	○	⊗	⊗	⊗	⊗	○	×	×	×
DTS SURROUND (DTS ES MTRX 6.1)	○	⊗	⊗	⊗	⊗	×	○	×	×
5/7CH STEREO	○	⊗	⊗	⊗	⊗	○	○	○	○
WIDE SCREEN	○	⊗	⊗	⊗	⊗	○	○	○	○
ROCK ARENA	○	⊗	⊗	⊗	⊗	○	○	○	○
JAZZ CLUB	○	⊗	⊗	⊗	⊗	○	○	○	○
VIDEO GAME	○	⊗	⊗	⊗	⊗	○	○	○	○
MONO MOVIE	○	⊗	⊗	⊗	⊗	○	○	○	○
MATRIX	○	⊗	⊗	⊗	⊗	○	○	○	○

○: Signal
 ×: No signal
 ⊗: Turned on or off by speaker configuration setting

○: Able
 ×: Unable
 * Only for 2 ch contents

Mode	Parameter (default values are shown in parentheses)												When playing Dolby Digital / DTS signals	
	TONE CONTROL	MODE	CINEMA EQ	EFFECT	LEVEL	ROOM SIZE	EFFECT LEVEL	DELAY TIME	SURROUND BACK	PRO LOGIC II MUSIC MODE ONLY			D.COMP	LFE
										PANORAMA	DIMENSION	CENTER WIDE		
DIRECT	×	×	×	×	×	×	×	×	×	×	×	×	○ (OFF)	○ (0dB)
STEREO	○ (0dB)	×	×	×	×	×	×	×	×	×	×	×	○ (OFF)	○ (0dB)
EXTERNAL INPUT	○ (0dB)	×	×	×	×	×	×	×	×	×	×	×	×	×
DOLBY PRO LOGIC II	○ (0dB)	○ (CINEMA)	○ (OFF)	×	×	×	×	×	○ (NON MTRX)	○ (OFF)	○ (3)	○ (0)	○ (OFF)	○ (0dB)
DTS NEO:6	○ (0dB)	○ (CINEMA)	○ (OFF)	×	×	×	×	×	○ (NON MTRX)	×	×	×	×	×
DOLBY DIGITAL (6.1 SURROUND)	○ (0dB)	×	○ (OFF)	×	×	×	×	×	○ (MTRX ON)	×	×	×	○ (OFF)	○ (0dB)
DTS SURROUND (DTS ES MTRX 6.1)	○ (0dB)	×	○ (OFF)	×	×	×	×	×	○ (MTRX ON)	×	×	×	○ (OFF)	○ (0dB)
5/7CH STEREO	○ (0dB)	×	×	×	×	×	×	×	×	×	×	×	○ (OFF)	○ (0dB)
WIDE SCREEN	○ (0dB)	×	○ (OFF)	○ (ON)	○ (10)	×	×	×	×	×	×	×	○ (OFF)	○ (0dB)
ROCK ARENA	○ (0dB)	×	×	×	×	○ (Medium)	○ (10)	×	×	×	×	×	○ (OFF)	○ (0dB)
JAZZ CLUB	○ (0dB)	×	×	×	×	○ (Medium)	○ (10)	×	×	×	×	×	○ (OFF)	○ (0dB)
VIDEO GAME	○ (0dB)	×	×	×	×	○ (Medium)	○ (10)	×	×	×	×	×	○ (OFF)	○ (0dB)
MONO MOVIE	○ (0dB)	×	×	×	×	○ (Medium)	○ (10)	×	×	×	×	×	○ (OFF)	○ (0dB)
MATRIX	○ (0dB)	×	×	×	×	×	×	○ (30msec)	×	×	×	×	○ (OFF)	○ (0dB)

○: Adjustable
 ×: Not adjustable

12 LISTENING TO THE RADIO

Auto tuning

1 Set the input function to "TUNER".



2 Press the RECEIVER button on the remote control unit to select "TUNER".



3 Watching the display, press the BAND button to select the desired band (AM or FM).

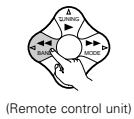

4 Press the MODE button to set the auto tuning mode. "Auto" appears on the display.

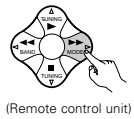

5 Press the TUNING UP or DOWN button. Automatic searching begins, then stops when a station is tuned in.

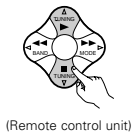

If tuning does not stop at the desired station, use to the "Manual tuning" operation.

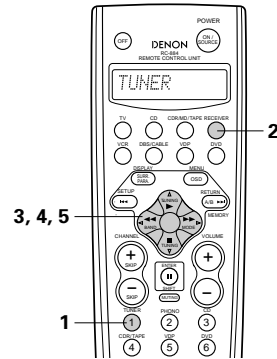
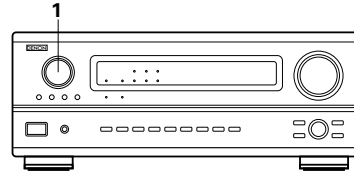

5 Press the TUNING UP or DOWN button to tune in the desired station. The frequency changes continuously when the button is held in.

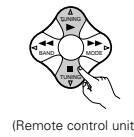

NOTES:

- When in the auto tuning mode on the FM band, the "STEREO" indicator lights on the display when a stereo broadcast is tuned in. At open frequencies, the noise is muted and the "TUNED" and "STEREO" indicators turn off.
- When the manual tuning mode is set, FM stereo broadcasts are received in monaural and the "STEREO" indicator turns off.

Preset memory

1 Use the "Auto tuning" or "Manual tuning" operation to tune in the station to be preset in the memory.

2 Press the MEMORY button.

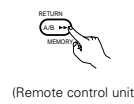

3 Press the SHIFT button and select the desired memory block (A to E).



4 Press the CHANNEL + (UP) or - (DOWN) button to select the desired preset channel (1 to 8).

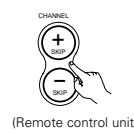

5 Press the MEMORY button again to store the station in the preset memory.

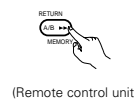

To preset other channels, repeat steps 2 to 5. A total of 40 broadcast stations can be preset — 8 stations (channels 1 to 8) in each of blocks A to E.

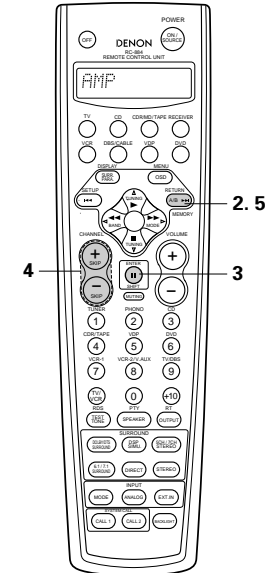

Manual tuning

1 Set the input function to "TUNER".



2 Press the RECEIVER button on the remote control unit to select "TUNER".

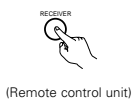

3 Watching the display, press the BAND button to select the desired band (AM or FM).

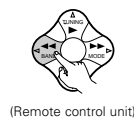

4 Press the MODE button to set the manual tuning mode. Check that the display's "AUTO" indicator turns off.

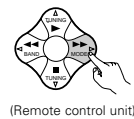

Checking the preset stations

The preset broadcast stations can be checked on the on screen display.

1 Press the OSD button repeatedly until the "Tuner Preset Stations" screen appears on the on screen display.

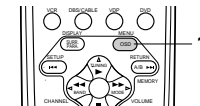

Tuner Preset Stations	
A1FM	87.50MHz
A2FM	89.10MHz
A3FM	90.10MHz
A4FM	90.80MHz
A5FM	90.10MHz
A6FM	90.10MHz
A7FM	90.10MHz
A8FM	90.10MHz

OSD-7

Recalling preset stations

- To call out preset stations from the remote control unit.

1  Watching the display, press the SHIFT button to select the preset memory block.

(Remote control unit)

2  Watching the display, press the CHANNEL + or - button to select the desired preset channel.

(Remote control unit)

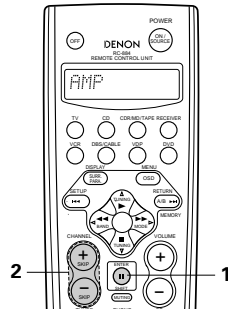

- Calling out preset stations from the main unit's panel.

1  Press the TUNING PRESET button.

(Main unit)

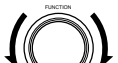
2  Turn the FUNCTION knob and select the desired station.

(Main unit)

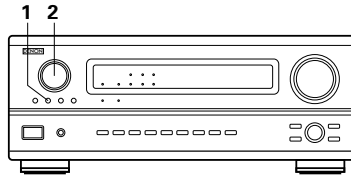

RDS (Radio Data System)

RDS (works only on the FM band) is a broadcasting service which allows station to send additional information along with the regular radio program signal. The following three types of RDS information can be received on this unit:

Program Type (PTY)

PTY identifies the type of RDS program. The program types and their displays are as follows:

NEWS	News	ROCK M	Rock Music	PHONE IN	Phone In
AFFAIRS	Current Affairs	EASY M	Easy Listening Music	TRAVEL	Travel
INFO	Information	LIGHT M	Light Classical	LEISURE	Leisure
SPORT	Sports	CLASSICS	Serious Classical	JAZZ	Jazz Music
EDUCATE	Education	OTHER M	Other Music	COUNTRY	Country Music
DRAMA	Drama	WEATHER	Weather	NATION M	National Music
CULTURE	Culture	FINANCE	Finance	OLDIES	Oldies Music
SCIENCE	Science	CHILDREN	Children's programmes	FOLK M	Folk Music
VARIED	Varied	SOCIAL	Social Affairs	DOCUMENT	Documentary
POP M	Pop Music	RELIGION	Religion		

Traffic Program (TP)

TP identifies programs that carry traffic announcements. This allows you to easily find out the latest traffic conditions in your area before you leaving home.

Radio Text (RT)

RT allows the RDS station to send text messages that appear on the display.

NOTE: The operations described below using the RDS, PTY and RT buttons will not function in areas in which there are no RDS broadcasts.

RDS search

Use this function to automatically tune to FM stations that provide RDS service.

1  Set the input function to "TUNER".

(Remote control unit)

2  Press the RECEIVER button on the remote control unit to select "TUNER".

(Remote control unit)

3  Press the RDS button until "RDS SEARCH" appears on the display.

(Remote control unit)

4  Press the CHANNEL + (UP) or - (DOWN) button to automatically begin the RDS search operation.

(Remote control unit)

If no RDS stations is found with above operation, all the reception band are searched.



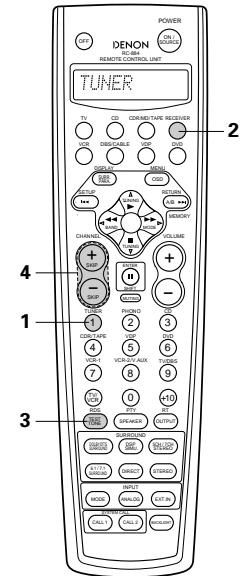

5 When a broadcast station is found, that station's name appears on the display.

6 To continue searching, repeat step 4. If no other RDS station is found when all the frequencies are searched, "NO RDS" is displayed.



PTY search

Use this function to find RDS stations broadcasting a designated program type (PTY). For a description of each program type, refer to "Program Type (PTY)".



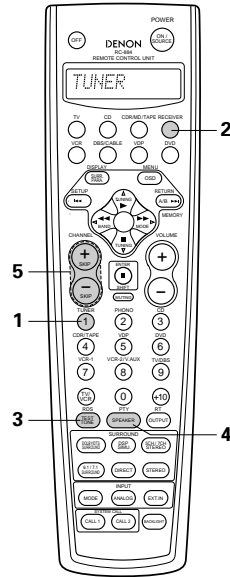

- 1**  Set the input function to "TUNER".
(Remote control unit)
- 2**  Press the RECEIVER button on the remote control unit to select "TUNER".
(Remote control unit)
- 3**  Press the RDS button until "PTY SEARCH" appears on the display.
(Remote control unit)
- 4**  Watching the display, press the PTY button to call out the desired program type.
(Remote control unit)
- 5**  Press the CHANNEL + (UP) or - (DOWN) button to automatically begin the PTY search operation.
(Remote control unit)

If there is no station broadcasting the designated program type with above operation, all the reception bands are searched.
- 6** The station name is displayed on the display after searching stops.
- 7** To continue searching, repeat step 5. If no other station broadcasting the designated program type is found when all the frequencies are searched, "NO PROGRAMME" is displayed.



TP search

Use this function to find RDS stations broadcasting traffic program (TP stations).

- 1**  Set the input function to "TUNER".
(Remote control unit)
- 2**  Press the RECEIVER button on the remote control unit to select "TUNER".
(Remote control unit)
- 3**  Press the RDS button until "TP SEARCH" appears on the display.
(Remote control unit)
- 4**  Press the CHANNEL + (UP) or - (DOWN) button TP search begins.
(Remote control unit)

If no TP station is found with above operation, all the reception bands are searched.
- 5** The station name is displayed on the display after searching stops.
- 6** To continue searching, repeat step 4. If no other TP station is found when all the frequencies are searched, "NO PROGRAMME" is displayed.

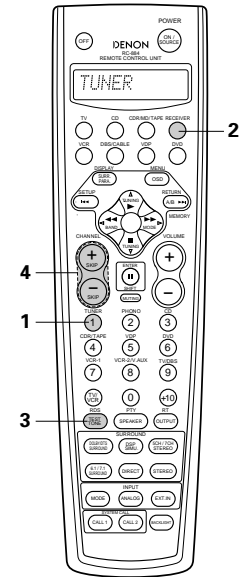

RT (Radio Text)

"RT" appears on the display when radio text data is received. When the RT button is pressed while receiving an RDS broadcast station, the text data broadcast from the station is displayed. To turn the display off, press the RT button again. If no text data is being broadcast, "NO TEXT DATA" is displayed.



13 LAST FUNCTION MEMORY

- This unit is equipped with a last function memory which stores the input and output setting conditions as they were immediately before the power is switched off. This function eliminates the need to perform complicated resettings when the power is switched on.
- The unit is also equipped with a back-up memory. This function provides approximately one week of memory storage when the main unit's power switch is off and with the power cord disconnected.

14 INITIALIZATION OF THE MICROPROCESSOR

When the indication of the display is not normal or when the operation of the unit does not shows the reasonable result, the initialization of the microprocessor is required by the following procedure.

- 1 Switch off the unit using the main unit's power operation switch.
- 2 Hold the following AUTO button and PCM button, and turn the main unit's power operation switch on.
- 3 Check that the entire display is flashing with an interval of about 1 second, and release your fingers from the 2 buttons and the microprocessor will be initialized.

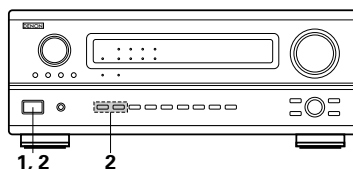

NOTES:

- If step 3 does not work, start over from step 1.
- If the microprocessor has been reset, all the button settings are reset to the default values (the values set upon shipment from the factory).

15 TROUBLESHOOTING

If a problem should arise, first check the following.

1. Are the connections correct ?
2. Have you operated the receiver according to the Operating Instructions ?
3. Are the speakers, turntable and other components operating properly ?

If this unit is not operating properly, check the items listed in the table below. Should the problem persist, there may be a malfunction.

Disconnect the power immediately and contact your store of purchase.

	Symptom	Cause	Measures	Page
Common problems when listening to the CD, records, tapes and FM broadcasts, etc.	DISPLAY not lit and sound not produced when power switch set to on.	<ul style="list-style-type: none"> • Power cord not plugged in securely. 	<ul style="list-style-type: none"> • Check the insertion of the power cord plug. • Turn the power on with the remote control unit after turning the POWER switch on. 	4 22
	DISPLAY lit but sound not produced.	<ul style="list-style-type: none"> • Speaker cords not securely connected. • Improper position of the audio function button. • Volume control set to minimum. • MUTING is on. • Digital signals not input Digital input selected. 	<ul style="list-style-type: none"> • Connect securely. • Set to a suitable position. • Turn volume up to suitable level. • Switch off MUTING. • Input digital signals or select input jacks to which digital signals are being input. 	8 23 23 24 23
	DISPLAY not lit and power indicator is flashing rapidly.	<ul style="list-style-type: none"> • Speaker terminals are short-circuited. • Block the ventilation holes of the set. • The unit is operating at continuous high power conditions and/or inadequate ventilation. 	<ul style="list-style-type: none"> • Switch power off, connect speakers properly, then switch power back on. • Turn off the set's power, then ventilate it well to cool it down. Once the set is cooled down, turn the power back on. • Turn off the set's power, then ventilate it well to cool it down. Once the set is cooled down, turn the power back on. 	8 3, 7 3, 7
	Sound produced only from one channel.	<ul style="list-style-type: none"> • Incomplete connection of speaker cords. • Incomplete connection of input/output cords. 	<ul style="list-style-type: none"> • Connect securely. • Connect securely. 	8 4 ~ 8
Common problems when listening to the CD, records, tapes and FM broadcasts, etc.	Positions of instruments reversed during stereo playback.	<ul style="list-style-type: none"> • Reverse connections of left and right speakers or left and right input/output cords. 	<ul style="list-style-type: none"> • Check left and right connections. 	8
	The on screen display is not displayed.	<ul style="list-style-type: none"> • "On screen display" is set to off on the system setup menu screen. 	<ul style="list-style-type: none"> • Set "on screen display" on the system setup menu screen to on. 	15
When playing records	Humming noise produced when record is playing.	<ul style="list-style-type: none"> • Ground wire of turntable not connected properly. • Incomplete PHONO jack connection. • TV or radio transmission antenna nearby. 	<ul style="list-style-type: none"> • Connect securely. • Connect securely. • Contact your store of purchase. 	4 4 —
	Howling noise produced when volume is high.	<ul style="list-style-type: none"> • Turntable and speaker systems too close together. • Floor is unstable and vibrates easily. 	<ul style="list-style-type: none"> • Separate as much as possible. • Use cushions to absorb speaker vibrations transmitted by floor. If turntable is not equipped with insulators, use audio insulators (commonly available). 	— —
	Sound is distorted.	<ul style="list-style-type: none"> • Stylus pressure too weak. • Dust or dirt on stylus. • Cartridge defective. 	<ul style="list-style-type: none"> • Apply proper stylus pressure. • Check stylus. • Replace cartridge. 	— — —
	Volume is weak.	<ul style="list-style-type: none"> • MC cartridge being used. 	<ul style="list-style-type: none"> • Replace with MM cartridge or use a head amplifier or step-up transformer. 	4

	Symptom	Cause	Measures	Page
Remote control unit	This unit does not operate properly when remote control unit is used.	• Batteries dead.	• Replace with new batteries.	16
		• Remote control unit too far from this unit.	• Move closer.	16
		• Obstacle between this unit and remote control unit.	• Remove obstacle.	—
		• Different button is being pressed.	• Press the proper button.	16
		• ⊕ and ⊖ ends of battery inserted in reverse.	• Insert batteries properly.	16

16 ADDITIONAL INFORMATION

Optimum surround sound for different sources

There are currently various types of multi-channel signals (signals or formats with more than two channels).

Types of multi-channel signals

Dolby Digital, Dolby Pro Logic, DTS, high definition 3-1 signals (Japan MUSE Hi-Vision audio), DVD-Audio, SACD (Super Audio CD), MPEG multi-channel audio, etc.

“Source” here does not refer to the type of signal (format) but the recorded content. Sources can be divided into two major categories.

Types of sources

- **Movie audio** Signals created to be played in movie theaters. In general sound is recorded to be played in movie theaters equipped with multiple surround speakers, regardless of the format (Dolby Digital, DTS, etc.).

Movie theater sound field

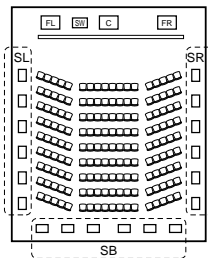

Multiple surround speakers
(For 6.1-channel system)

Listening room sound field

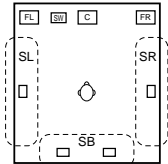

In this case it is important to achieve the same sense of expansion as in a movie theater with the surround channels. To do so, in some cases the number of surround speakers is increased (to four or eight) or speakers with bipolar or dipolar properties are used.

(SL: Surround L channel
SR: Surround R channel
SB: Surround back channel

- **Other types of audio** These signals are designed to recreate a 360° sound field using three to five speakers.

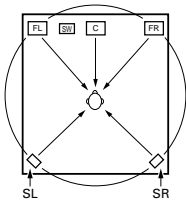

In this case the speakers should surround the listener from all sides to create a uniform sound field from 360°. Ideally the surround speakers should function as “point” sound sources in the same way as the front speakers.

These two types of sources thus have different properties, and different speaker settings, particularly for the surround speakers, are required in order to achieve the ideal sound.

The AVR-3802's surround speaker selection function makes it possible to change the settings according to the combination of surround speakers being used and the surrounding environment in order to achieve the ideal surround sound for all sources. This means that you can connect a pair of bipolar or dipolar surround speakers (mounted on either side of the prime listening position), as well as a separate pair of direct radiating (monopolar) speakers placed at the rear corners of the listening room.

Surround back speakers

A 6.1-channel system is a conventional 5.1-channel system to which the “surround back” (SB) channel has been added. This makes it easy to achieve sound positioned directly behind the listener, something that was previously difficult with sources designed for conventional multi surround speakers. In addition, the acoustic image extending between the sides and the rear is narrowed, thus greatly improving the expression of the surround signals for sounds moving from the sides to the back and from the front to the point directly behind the listening position.

Change of positioning and acoustic image with 5.1-channel systems

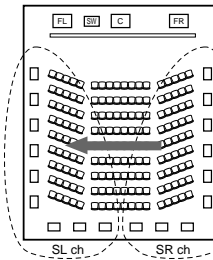

Movement of acoustic image from SR to SL

Change of positioning and acoustic image with 6.1-channel systems

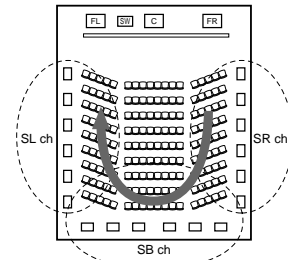

Movement of acoustic image from SR to SB to SL

With this set, speaker(s) for 1 or 2 channels are required to achieve a 6.1-channel system (DTS-ES, etc.). Adding these speakers, however, increases the surround effect not only with sources recorded in 6.1 channels but also with conventional 2- to 5.1-channel sources. The WIDE SCREEN mode is a mode for achieving surround sound with up to 7.1 channels using surround back speakers, for sources recorded in conventional Dolby Surround as well as Dolby Digital 5.1-channel and DTS Surround 5.1-channel sources. Furthermore, all the Denon original surround modes (see page 30) are compatible with 7.1-channel playback, so you can enjoy 7.1-channel sound with any signal source.

Number of surround back speakers

Though the surround back channel only consists of 1 channel of playback signals for 6.1-channel sources (DTS-ES, etc.), we recommend using two speakers. When using speakers with dipolar characteristics in particular, it is essential to use two speakers.

Using two speakers results in a smoother blend with the sound of the surround channels and better sound positioning of the surround back channel when listening from a position other than the center.

Placement of the surround left and right channels when using surround back speakers

Using surround back speakers greatly improves the positioning of the sound at the rear. Because of this, the surround left and right channels play an important role in achieving a smooth transition of the acoustic image from the front to the back. As shown on the diagram above, in a movie theater the surround signals are also produced from diagonally in front of the listeners, creating an acoustic image as if the sound were floating in space.

To achieve these effects, we recommend placing the speakers for the surround left and right channels slightly more towards the front than with conventional surround systems. Doing so sometimes increases the surround effect when playing conventional 5.1-channel sources in the 6.1 surround or DTS-ES Matrix 6.1 mode. Check the surround effects of the various modes before selecting the surround mode.

Speaker setting examples

Here we describe a number of speaker settings for different purposes. Use these examples as guides to set up your system according to the type of speakers used and the main usage purpose.

1. DTS-ES compatible system (using surround back speakers)

(1) Basic setting for primarily watching movies

This is recommended when mainly playing movies and using regular single way or 2-way speakers for the surround speakers.

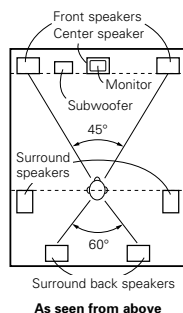

- Set the front speakers with their front surfaces as flush with the TV or monitor screen as possible. Set the center speaker between the front left and right speakers and no further from the listening position than the front speakers.
- Consult the owner's manual for your subwoofer for advice on placing the subwoofer within the listening room.
- If the surround speakers are direct-radiating (monopolar) then place them slightly behind and at an angle to the listening position and parallel to the walls at a position 60 to 90 centimeters (2 to 3 feet) above ear level at the prime listening position.
- When using two surround back speakers, place them at the back facing the front at a narrower distance than the front left and right speakers. When using one surround back speaker, place it at the rear center facing the front at a slightly higher position (0 to 20 cm) than the surround speakers.
- We recommend installing the surround back speaker(s) at a slightly downward facing angle. This effectively prevents the surround back channel signals from reflecting off the monitor or screen at the front center, resulting in interference and making the sense of movement from the front to the back less sharp.
- Connect the surround speakers to the surround speaker A jacks on the AVR-3802 and set all settings on the setup menu to "A". (This is the factory default setting. For details, see page 9.)

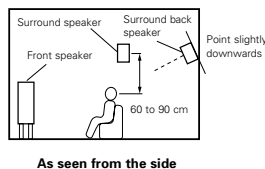

(3) When using different surround speakers for movies and music

To achieve more effective surround sound for both movies and music, use different sets of surround speakers and different surround modes for the two types of sources.

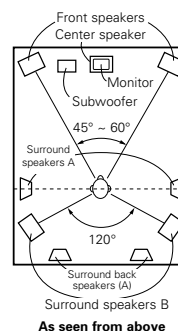

- Set the front speakers slightly wider apart than the setup for watching movies only and point them toward the listening position in order assure clear positioning of the sound.
- Set the center speaker in the same positions as in example (1).
- Set surround speakers A for watching movies in the positions described in example (1) or (2), depending on the types of speakers used.
- Set surround speakers B for playing multi-channel music at the same height as the front speakers and slightly at an angle to the rear of the listening position.
- Connect the surround speakers for watching movies to the surround speaker A jacks on the AVR-3802, the surround speakers for playing multi-channel music to the surround speaker B jacks. Set the surround speaker selection on the setup menu. (For instructions, see page 10.)

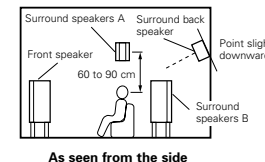

(2) Setting for primarily watching movies using diffusion type speakers for the surround speakers

For the greatest sense of surround sound envelopment, diffuse radiation speakers such as bipolar types, or dipolar types, provide a wider dispersion than is possible to obtain from a direct radiating speaker (monopolar). Place these speakers at either side of the prime listening position, mounted above ear level.

Path of the surround sound from the speakers to the listening position

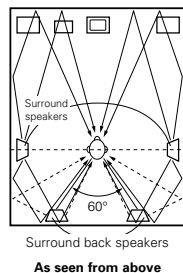

- Set the front speakers, center speaker and subwoofer in the same positions as in example (1).
- It is best to place the surround speakers directly at the side or slightly to the front of the viewing position, and 60 to 90 cm above the ears.
- Same as surround back speaker installation method (1). Using dipolar speakers for the surround back speakers as well is more effective.
- Connect the surround speakers to the surround speaker A jacks on the AVR-3802 and set all settings on the setup menu to "A". (This is the factory default setting. For details, see page 9.)
- The signals from the surround channels reflect off the walls as shown on the diagram at the left, creating an enveloping and realistic surround sound presentation. For multi-channel music sources however, the use of bipolar or dipolar speakers mounted at the sides of the listening position may not be satisfactory in order to create a coherent 360 degree surround sound field. Connect another pair of direct radiating speakers as described in example (3) and place them at the rear corners of the room facing towards the prime listening position.

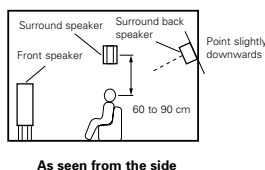

2. When not using surround back speakers

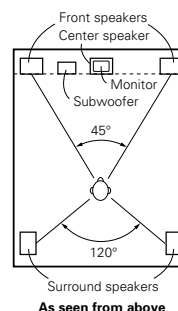

- Set the front speakers with their front surfaces as flush with the TV or monitor screen as possible. Set the center speaker between the front left and right speakers and no further from the listening position than the front speakers.
- Consult the owner's manual for your subwoofer for advice on placing the subwoofer within the listening room.
- If the surround speakers are direct-radiating (monopolar) then place them slightly behind and at an angle to the listening position and parallel to the walls at a position 60 to 90 centimeters above ear level at the prime listening position.
- Connect the surround speakers to the surround speaker A jacks on the AVR-3802 and set all settings on the setup menu to "A". (This is the factory default setting. For details, see page 9.)

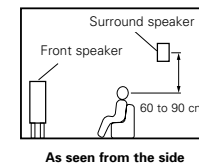

Surround

The AVR-3802 is equipped with a digital signal processing circuit that lets you play program sources in the surround mode to achieve the same sense of presence as in a movie theater.

Dolby Surround

(1) Dolby Digital (Dolby Surround AC-3)

Dolby Digital is the multi-channel digital signal format developed by Dolby Laboratories. Dolby Digital consists of up to "5.1" channels - front left, front right, center, surround left, surround right, and an additional channel exclusively reserved for additional deep bass sound effects (the Low Frequency Effects – LFE – channel, also called the ".1" channel, containing bass frequencies of up to 120 Hz). Unlike the analog Dolby Pro Logic format, Dolby Digital's main channels can all contain full range sound information, from the lowest bass, up to the highest frequencies – 22 kHz. The signals within each channel are distinct from the others, allowing pinpoint sound imaging, and Dolby Digital offers tremendous dynamic range from the most powerful sound effects to the quietest, softest sounds, free from noise and distortion.

■ Dolby Digital and Dolby Pro Logic

Comparison of home surround systems	Dolby Digital	Dolby Pro Logic
No. recorded channels (elements)	5.1 ch	2 ch
No. playback channels	5.1 ch	4 ch
Playback channels (max.)	L, R, C, SL, SR, SW	L, R, C, S (SW - recommended)
Audio processing	Digital discrete processing Dolby Digital (AC-3) encoding/decoding	Analog matrix processing Dolby Surround
High frequency playback limit of surround channel	20 kHz	7 kHz

■ Dolby Digital compatible media and playback methods

Marks indicating Dolby Digital compatibility:  and .

The following are general examples. Also refer to the player's operating instructions.

Media	Dolby Digital output jacks	Playback method (reference page)
LD (VDP)	Coaxial Dolby Digital RF output jack ※ 1	Set the input mode to "AUTO". (Page 23)
DVD	Optical or coaxial digital output (same as for PCM) ※ 2	Set the input mode to "AUTO". (Page 23)
Others (satellite broadcasts, CATV, etc.)	Optical or coaxial digital output (same as for PCM)	Set the input mode to "AUTO". (Page 23)

- ※ 1 Please use a commercially available adapter when connecting the Dolby Digital RF (AC-3RF) output jack of the LD player to the digital input jack.
Please refer to the instruction manual of the adapter when making connection.
- ※ 2 Some DVD digital outputs have the function of switching the Dolby Digital signal output method between "bit stream" and "(convert to) PCM". When playing in Dolby Digital surround on the AVR-3802, switch the DVD player's output mode to "bit stream". In some cases players are equipped with both "bit stream + PCM" and "PCM only" digital outputs. In this case connect the "bit stream + PCM" jacks to the AVR-3802.

(2) Dolby Pro Logic II

- Dolby Pro-Logic II is a new multi-channel playback format developed by Dolby Laboratories using feedback logic steering technology and offering improvements over conventional Dolby Pro Logic circuits.
- Dolby Pro Logic II can be used to decode not only sources recorded in Dolby Surround (※) but also regular stereo sources into five channels (front left, front right, center, surround left and surround right) to achieve surround sound.
- Whereas with conventional Dolby Pro Logic the surround channel playback frequency band was limited, Dolby Pro Logic II offers a wider band range (20 Hz to 20 kHz or greater). In addition, the surround channels were monaural (the surround left and right channels were the same) with previous Dolby Pro Logic, but Dolby Pro Logic II they are played as stereo signals.
- Various parameters can be set according to the type of source and the contents, so it is possible to achieve optimum decoding (see page 27).

※ Sources recorded in Dolby Surround
These are sources in which three or more channels of surround have been recorded as two channels of signals using Dolby Surround encoding technology. Dolby Surround is used for the sound tracks of movies recorded on DVDs, LDs and video cassettes to be played on stereo VCRs, as well as for the stereo broadcast signals of FM radio, TV, satellite broadcasts and cable TV. Decoding these signals with Dolby Pro Logic makes it possible to achieve multi-channel surround playback. The signals can also be played on ordinary stereo equipment, in which case they provide normal stereo sound.

There are two types of DVD Dolby surround recording signals.

- ① 2-channel PCM stereo signals
- ② 2-channel Dolby Digital signals

When either of these signals is input to the AVR-3802, the surround mode is automatically set to Dolby Pro Logic II when the "DOLBY/DTS SURROUND" mode is selected.

■ Sources recorded in Dolby Surround are indicated with the logo mark shown below.

Dolby Surround support mark: 



Manufactured under license from Dolby Laboratories. "Dolby", "Pro Logic" and the double-D symbol are trademarks of Dolby Laboratories. Confidential unpublished works, ©1992-1999 Dolby Laboratories. All rights reserved.

DTS Digital Surround

Digital Theater Surround (also called simply DTS) is a multi-channel digital signal format developed by Digital Theater Systems.

DTS offers the same "5.1" playback channels as Dolby Digital (front left, front right and center, surround left and surround right) as well as the stereo 2-channel mode. The signals for the different channels are fully independent, eliminating the risk of deterioration of sound quality due to interference between signals, crosstalk, etc. DTS features a relatively higher bit rate as compared to Dolby Digital (1234 kbps for CDs and LDs, 1536 kbps for DVDs) so it operates with a relatively low compression rate. Because of this the amount of data is great, and when DTS playback is used in movie theaters, a separate CD-ROM synchronized with the film is played. With LDs and DVDs, there is of course no need for an extra disc; the pictures and sound can be recorded simultaneously on the same disc, so the discs can be handled in the same way as discs with other formats. There are also music CDs recorded in DTS. These CDs include 5.1-channel surround signals (compared to two channels on current CDs). They do not include picture data, but they offer surround playback on CD players that are equipped with digital outputs (PCM type digital output required). DTS surround track playback offers the same intricate, grand sound as in a movie theater, right in your own listening room.

■ **DTS compatible media and playback methods**

Marks indicating DTS compatibility:  and .

The following are general examples. Also refer to the player's operating instructions.

Media	Dolby Digital output jacks	Playback method (reference page)
CD	Optical or coaxial digital output (same as for PCM) ※ 2	Set the input mode to "AUTO" or "DTS" (page 23). Never set the mode to "ANALOG" or "PCM". ※ 1
LD (VDP)	Optical or coaxial digital output (same as for PCM) ※ 2	Set the input mode to "AUTO" or "DTS" (page 23). Never set the mode to "ANALOG" or "PCM". ※ 1
DVD	Optical or coaxial digital output (same as for PCM) ※ 3	Set the input mode to "AUTO" or "DTS" (page 23).

- ※ 1 DTS signals are recorded in the same way on CDs and LDs as PCM signals. Because of this, the undecoded DTS signals are output as random "hissy" noise from the CD or LD player's analog outputs. If this noise is played with the amplifier set at a very high volume, it may possibly cause damage to the speakers. To avoid this, be sure to switch the input mode to "AUTO" or "DTS" before playing CDs or LDs recorded in DTS. Also, never switch the input mode to "ANALOG" or "PCM" during playback. The same holds true when playing CDs or LDs on a DVD player or LD/DVD compatible player. For DVDs, the DTS signals are recorded in a special way so this problem does not occur.
- ※ 2 The signals provided at the digital outputs of a CD or LD player may undergo some sort of internal signal processing (output level adjustment, sampling frequency conversion, etc.). In this case the DTS-encoded signals may be processed erroneously, in which case they cannot be decoded by the AVR-3802, or may only produce noise. Before playing DTS signals for the first time, turn down the master volume to a low level, start playing the DTS disc, then check whether the DTS indicator on the AVR-3802 (see page 29) lights before turning up the master volume.
- ※ 3 A DVD player with DTS-compatible digital output is required to play DTS DVDs. A DTS Digital Output logo is featured on the front panel of compatible DVD players. Recent DENON DVD player models feature DTS-compatible digital output – consult the player's owner's manual for information on configuring the digital output for DTS playback of DTS-encoded DVDs.

Manufactured under license from Digital Theater Systems, Inc. US Pat. No. 5,451,942, 5,956,674, 5,974,380, 5,978,762 and other world-wide patents issued and pending. "DTS", "DTS-ES Extended Surround" and "Neo:6" are trademarks of Digital Theater Systems, Inc. ©1996, 2000 Digital Theater Systems, Inc. All Rights Reserved.

DTS-ES Extended Surround™

DTS-ES Extended Surround is a new multi-channel digital signal format developed by Digital Theater Systems Inc. While offering high compatibility with the conventional DTS Digital Surround format, DTS-ES Extended Surround greatly improves the 360-degree surround impression and space expression thanks to further expanded surround signals. This format has been used professionally in movie theaters since 1999.

In addition to the 5.1 surround channels (FL, FR, C, SL, SR and LFE), DTS-ES Extended Surround also offers the SB (Surround Back, sometimes also referred to as "surround center") channel for surround playback with a total of 6.1 channels. DTS-ES Extended Surround includes two signal formats with different surround signal recording methods, as described below.

■ **DTS-ES™ Discrete 6.1**

DTS-ES™ Discrete 6.1 is the newest recording format. With it, all 6.1 channels (including the SB channel) are recorded independently using a digital discrete system. The main feature of this format is that because the SL, SR and SB channels are fully independent, the sound can be designed with total freedom and it is possible to achieve a sense that the acoustic images are moving about freely among the background sounds surrounding the listener from 360 degrees.

Though maximum performance is achieved when sound tracks recorded with this system are played using a DTS-ES decoder, when played with a conventional DTS decoder the SB channel signals are automatically down-mixed to the SL and SR channels, so none of the signal components are lost.

■ **DTS-ES™ Matrix 6.1**

With this format, the additional SB channel signals undergo matrix encoding and are input to the SL and SR channels beforehand. Upon playback they are decoded to the SL, SR and SB channels. The performance of the encoder used at the time of recording can be fully matched using a high precision digital matrix decoder developed by DTS, thereby achieving surround sound more faithful to the producer's sound design aims than with conventional 5.1- or 6.1-channel systems.

In addition, the bit stream format is 100% compatible with conventional DTS signals, so the effect of the Matrix 6.1 format can be achieved even with 5.1-channel signal sources. Of course it is also possible to play DTS-ES Matrix 6.1 encoded sources with a DTS 5.1-channel decoder.

When DTS-ES Discrete 6.1 or Matrix 6.1 encoded sources are decoded with a DTS-ES decoder, the format is automatically detected upon decoding and the optimum playing mode is selected. However, some Matrix 6.1 sources may be detected as having a 5.1-channel format, so the DTS-ES Matrix 6.1 mode must be set manually to play these sources.

(For instructions on selecting the surround mode, see page 30.)

The DTS-ES decoder includes another function, the DTS Neo:6 surround mode for 6.1-channel playback of digital PCM and analog signal sources.

■ **DTS Neo:6™ surround**

This mode applies conventional 2-channel signals to the high precision digital matrix decoder used for DTS-ES Matrix 6.1 to achieve 6.1-channel surround playback. High precision input signal detection and matrix processing enable full band reproduction (frequency response of 20 Hz to 20 kHz or greater) for all 6.1 channels, and separation between the different channels is improved to the same level as that of a digital discrete system.

DTS Neo:6 surround includes two modes for selecting the optimum decoding for the signal source.

• **DTS Neo:6 Cinema**

This mode is optimum for playing movies. Decoding is performed with emphasis on separation performance to achieve the same atmosphere with 2-channel sources as with 6.1-channel sources.

This mode is effective for playing sources recorded in conventional surround formats as well, because the in-phase component is assigned mainly to the center channel (C) and the reversed phase component to the surround (SL, SR and SB channels).

• **DTS Neo:6 Music**

This mode is suited mainly for playing music. The front channel (FL and FR) signals bypass the decoder and are played directly so there is no loss of sound quality, and the effect of the surround signals output from the center (C) and surround (SL, SR and SB) channels add a natural sense of expansion to the sound field.

System setup items and default values (set upon shipment from the factory)

System setup			Default settings								
①	Power AMP Assignment	Set this to switch the surround back channel's power amplifier for use for multi-zone.	Surround Back								
	Speaker Configuration	Input the combination of speakers in your system and their corresponding sizes (SMALL for regular speakers, LARGE for full-size, full-range) to automatically set the composition of the signals output from the speakers and the frequency response.	Front Sp.	Center Sp.	Sub Woofer	Surround Sp. A/B		Surround Back Sp.			
			Large	Small	Yes	Small		Small / 2spkrs			
②	(Surround Speaker Setting)	Use this function when using multiple surround speaker combinations for more ideal surround sound. Once the combinations of surround speakers to be used for the different surround modes are preset, the surround speakers are selected automatically according to the surround mode.	Surround mode	DOLBY/DTS SURROUND	5CH/7CH STEREO	DSP SIMULATION	EXT. IN	—	—		
			Surround speaker	A	A	A	A	—	—		
	Crossover Frequency	Set the frequency (Hz) below which the bass sound of the various speakers is to be output from the subwoofer.	80 Hz								
	(Subwoofer mode)	This selects the subwoofer speaker for playing deep bass signals.	LFE								
③	SB CH Auto Flag Detect	Set the method of playing the surround backchannel for digital signals.	DTS-ES / 6.1 Source Auto Flag Detect Mode = OFF								
④	Delay Time	This parameter is for optimizing the timing with which the audio signals are produced from the speakers and subwoofer according to the listening position.	Front L & R	Center	Sub Woofer	Surround L & R		SBL & SBR			
			3.6 m (12 ft)	3.6 m (12 ft)	3.6 m (12 ft)	3.0 m (10 ft)		3.0 m (10 ft)			
⑤	Channel Level	This adjusts the volume of the signals output from the speakers and subwoofer for the different channels in order to obtain optimum effects.	Front L	Front R	Center	Surround L	Surround R	Surround Back L	Surround Back R	Subwoofer	
			0 dB	0 dB	0 dB	0 dB	0 dB	0 dB	0 dB	0 dB	0 dB
⑥	Digital In Assignment	This assigns the digital input jacks for the different input sources.	Input source	CD	DVD	TV/DBS	CDR /TAPE	VDP	VCR-1	VCR-2	—
			Digital Inputs	COAXIAL	OPTICAL 1	OPTICAL 2	OPTICAL 3	OFF	OFF	OFF	OFF
⑦	Multi vol. Level	This sets the output level for the multi output jacks.	0 dB								
⑧	On Screen Display	This sets whether or not to display the on-screen display that appears on the monitor screen when the controls on the remote control unit or main unit are operated.	On Screen Display = ON								
⑨	Auto Tuner Preset	FM stations are received automatically and stored in the memory.	A1 ~ A8	87.5 / 89.1 / 98.1 / 108.0 / 90.1 / 90.1 / 90.1 / 90.1 MHz							
			B1 ~ B8	522 / 603 / 999 / 1404 / 1611 kHz, 90.1 / 90.1 MHz							
			C1 ~ C8	90.1 MHz							
			D1 ~ D8	90.1 MHz							
			E1 ~ E8	90.1 MHz							

Surround modes and parameters

Mode	Channel output					When playing Dolby Digital Signals	When playing DTS signals	When playing PCM signals	When playing ANALOG signals
	Front L/R	CENTER	SURROUND L/R	SUB-WOOFER	SURROUND BACK L/R				
DIRECT	○	×	×	⊗	×	○	○	○	○
STEREO	○	×	×	⊗	×	○	○	○	○
EXTERNAL INPUT	○	⊗	⊗	⊗	⊗	×	×	×	○
DOLBY PRO LOGIC II	○	⊗	⊗	⊗	⊗	* ○	×	○	○
DTS NEO:6	○	⊗	⊗	⊗	⊗	×	×	○	○
DOLBY DIGITAL (6.1 SURROUND)	○	⊗	⊗	⊗	⊗	○	×	×	×
DTS SURROUND (DTS ES MTRX 6.1)	○	⊗	⊗	⊗	⊗	×	○	×	×
5/7CH STEREO	○	⊗	⊗	⊗	⊗	○	○	○	○
WIDE SCREEN	○	⊗	⊗	⊗	⊗	○	○	○	○
ROCK ARENA	○	⊗	⊗	⊗	⊗	○	○	○	○
JAZZ CLUB	○	⊗	⊗	⊗	⊗	○	○	○	○
VIDEO GAME	○	⊗	⊗	⊗	⊗	○	○	○	○
MONO MOVIE	○	⊗	⊗	⊗	⊗	○	○	○	○
MATRIX	○	⊗	⊗	⊗	⊗	○	○	○	○

○: Signal
 ×: No signal
 ⊗: Turned on or off by speaker configuration setting

○: Able
 ×: Unable
 * Only for 2 ch contents

Mode	Parameter (default values are shown in parentheses)													
	TONE CONTROL	MODE	CINEMA EQ	EFFECT	LEVEL	ROOM SIZE	EFFECT LEVEL	DELAY TIME	SURROUND BACK	PRO LOGIC II MUSIC MODE ONLY			When playing Dolby Digital / DTS signals	
										PANORAMA	DIMENSION	CENTER WIDE	D. COMP	LFE
DIRECT	×	×	×	×	×	×	×	×	×	×	×	×	○ (OFF)	○ (0dB)
STEREO	○ (0dB)	×	×	×	×	×	×	×	×	×	×	×	○ (OFF)	○ (0dB)
EXTERNAL INPUT	○ (0dB)	×	×	×	×	×	×	×	×	×	×	×	×	×
DOLBY PRO LOGIC II	○ (0dB)	○ (CINEMA)	○ (OFF)	×	×	×	×	×	○ (NON MTRX)	○ (OFF)	○ (3)	○ (0)	○ (OFF)	○ (0dB)
DTS NEO:6	○ (0dB)	○ (CINEMA)	○ (OFF)	×	×	×	×	×	○ (NON MTRX)	×	×	×	×	×
DOLBY DIGITAL (6.1 SURROUND)	○ (0dB)	×	○ (OFF)	×	×	×	×	×	○ (MTRX ON)	×	×	×	○ (OFF)	○ (0dB)
DTS SURROUND (DTS ES MTRX 6.1)	○ (0dB)	×	○ (OFF)	×	×	×	×	×	○ (MTRX ON)	×	×	×	○ (OFF)	○ (0dB)
5/7CH STEREO	○ (0dB)	×	×	×	×	×	×	×	×	×	×	×	○ (OFF)	○ (0dB)
WIDE SCREEN	○ (0dB)	×	○ (OFF)	○ (ON)	○ (10)	×	×	×	×	×	×	×	○ (OFF)	○ (0dB)
ROCK ARENA	○ (0dB)	×	×	×	×	○ (Medium)	○ (10)	×	×	×	×	×	○ (OFF)	○ (0dB)
JAZZ CLUB	○ (0dB)	×	×	×	×	○ (Medium)	○ (10)	×	×	×	×	×	○ (OFF)	○ (0dB)
VIDEO GAME	○ (0dB)	×	×	×	×	○ (Medium)	○ (10)	×	×	×	×	×	○ (OFF)	○ (0dB)
MONO MOVIE	○ (0dB)	×	×	×	×	○ (Medium)	○ (10)	×	×	×	×	×	○ (OFF)	○ (0dB)
MATRIX	○ (0dB)	×	×	×	×	×	×	○ (30msec)	×	×	×	×	○ (OFF)	○ (0dB)

○: Adjustable
 ×: Not adjustable

17 SPECIFICATIONS

■ Audio section

• Power amplifier

Rated output:	Front:	105 W + 105 W	(8 Ω/ohms, 20 Hz ~ 20 kHz with 0.05% T.H.D.)
		150 W + 150 W	(6 Ω/ohms, 1 kHz with 0.7% T.H.D.)
Center:		105 W	(8 Ω/ohms, 20 Hz ~ 20 kHz with 0.05% T.H.D.)
		150 W	(6 Ω/ohms, 1 kHz with 0.7% T.H.D.)
Surround:		105 W + 105 W	(8 Ω/ohms, 20 Hz ~ 20 kHz with 0.05% T.H.D.)
		150 W + 150 W	(6 Ω/ohms, 1 kHz with 0.7% T.H.D.)
Surround back:		105 W + 105 W	(8 Ω/ohms, 20 Hz ~ 20 kHz with 0.05% T.H.D.)
		150 W + 150 W	(6 Ω/ohms, 1 kHz with 0.7% T.H.D.)

Dynamic power:	140 W x 2 ch	(8 Ω/ohms)
	210 W x 2 ch	(4 Ω/ohms)
	240 W x 2 ch	(2 Ω/ohms)

Output terminals:	Front, Center, Surr. Back/Multi Zone:	6 ~ 16 Ω/ohms
	Surround:	A or B 6 ~ 16 Ω/ohms
		A + B 8 ~ 16 Ω/ohms

• Analog

Input sensitivity / input impedance:	200 mV / 47 kΩ/kohms
Frequency response:	10 Hz ~ 100 kHz: +0, -3 dB (DIRECT mode)
S/N:	102 dB (DIRECT mode)
Distortion:	0.005% (20 Hz ~ 20 kHz) (DIRECT mode)
Rated output:	1.2 V

• Digital

D/A output:	Rated output — 2 V (at 0 dB playback)
	Total harmonic distortion — 0.008% (1 kHz, at 0 dB)
	S/N ratio — 102 dB
	Dynamic range — 96 dB
	Format — Digital audio interface

Digital input:

• Phono equalizer (PHONO input — REC OUT)

Input sensitivity:	2.5 mV
RIAA deviation:	±1 dB (20 Hz to 20 kHz)
Signal-to-noise ratio:	74 dB (A weighting, with 5 mV input)
Rated output / Maximum output:	150 mV / 8 V
Distortion factor:	0.03% (1 kHz, 3 V)

■ Video section

• Standard video jacks

Input / output level and impedance:	1 Vp-p, 75 Ω/ohms
Frequency response:	5 Hz ~ 10 MHz — +0, -3 dB

• S-video jacks

Input / output level and impedance:	Y (brightness) signal — 1 Vp-p, 75 Ω/ohms
	C (color) signal — 0.286 Vp-p, 75 Ω/ohms
Frequency response:	5 Hz ~ 10 MHz — +0, -3 dB

• Color component video terminal

Input / output level and impedance:	Y (brightness) signal — 1 Vp-p, 75 Ω/ohms
	P _B /C _B (blue) signal — 0.7 Vp-p, 75 Ω/ohms
	P _R /C _R (red) signal — 0.7Vp-p, 75 Ω/ohms
Frequency response:	5 Hz ~ 27 MHz — +0, -3 dB

■ Tuner section

Reseiving Range:	[FM] (note: μV at 75 Ω/ohms, 0 dBf=1 x 10 ⁻¹⁵ W)	[AM]
Usable Sensitivity:	87.50 MHz ~ 108.00 MHz	522 kHz ~ 1611 kHz
50 dB Quieting Sensitivity:	1.0 μV (11.2 dBf)	18 μV
S/N (IHF-A):	MONO 1.6 μV (15.3 dBf)	
	STEREO 23 μV (38.5 dBf)	
Total Harmonic Distortion (at 1 kHz):	MONO 80 dB	
	STEREO 75 dB	
	MONO 0.4%	
	STEREO 0.5%	

■ General

Power supply:	AC 230 V, 50 Hz
Power consumption:	400 W
	2 W (Standby)
Maximum external dimensions:	434 (W) x 171 (H) x 416 (D) mm
Mass:	16.5 kg

■ Remote control unit (RC-884)

Batteries:	R6P/AA Type (three batteries)
External dimensions:	61 (W) x 230 (H) x 34 (D) mm
Mass:	200 g (not including batteries)

* For purposes of improvement, specifications and design are subject to change without notice.

Free Manuals Download Website

<http://myh66.com>

<http://usermanuals.us>

<http://www.somanuals.com>

<http://www.4manuals.cc>

<http://www.manual-lib.com>

<http://www.404manual.com>

<http://www.luxmanual.com>

<http://aubethermostatmanual.com>

Golf course search by state

<http://golfingnear.com>

Email search by domain

<http://emailbydomain.com>

Auto manuals search

<http://auto.somanuals.com>

TV manuals search

<http://tv.somanuals.com>