

DENON

AM-FM STEREO TUNER

TU-1500RD

OPERATING INSTRUCTIONS

MODE D'EMPLOI

INSTRUCCIONES DE OPERACION

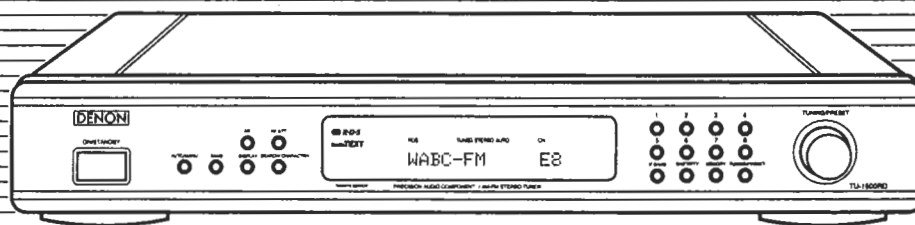

FOR ENGLISH READERS	PAGE	2 ~ 10, 23
POUR LES LECTEURS FRANCAIS	PAGE	2, 4, 5, 11 ~ 16, 23
PARA LECTORES DE ESPAÑOL	PAGINA	2, 4, 5, 17 ~ 22, 23

"SERIAL NO. _____

PLEASE RECORD UNIT SERIAL NUMBER ATTACHED TO THE REAR OF THE CABINET FOR FUTURE REFERENCE"

Download from [Www.Somanuals.com](http://www.Somanuals.com). All Manuals Search And Download.



CAUTION
RISK OF ELECTRIC SHOCK
DO NOT OPEN



CAUTION: TO REDUCE THE RISK OF ELECTRIC SHOCK, DO NOT REMOVE COVER (OR BACK). NO USER SERVICEABLE PARTS INSIDE. REFER SERVICING TO QUALIFIED SERVICE PERSONNEL.



The lightning flash with arrowhead symbol, within an equilateral triangle, is intended to alert the user to the presence of uninsulated "dangerous voltage" within the product's enclosure that may be of sufficient magnitude to constitute a risk of electric shock to persons.



The exclamation point within an equilateral triangle is intended to alert the user to the presence of important operating and maintenance (servicing) instructions in the literature accompanying the appliance.

WARNING: TO REDUCE THE RISK OF FIRE OR ELECTRIC SHOCK, DO NOT EXPOSE THIS APPLIANCE TO RAIN OR MOISTURE.

• **FOR U.S.A. & CANADA MODEL ONLY**

CAUTION

TO PREVENT ELECTRIC SHOCK, DO NOT USE THIS (POLARIZED) PLUG WITH AN EXTENSION CORD, RECEPTACLE OR OTHER OUTLET UNLESS THE BLADES CAN BE FULLY INSERTED TO PREVENT BLADE EXPOSURE.

• **POUR LES MODELES AMERICAINS ET CANADIENS UNIQUEMENT**

ATTENTION

POUR PREVENIR LES CHOCS ELECTRIQUES NE PAS UTILISER CETTE FICHE POLARISEE AVEC UN PROLONGATEUR, UNE PRISE DE COURANT OU UNE AUTRE SORTIE DE COURANT, SAUF SI LES LAMES PEUVENT ETRE INSEREES A FOND SANS EN LAISSER AUCUNE PARTIE A DECOUVERT.

This device complies with Part 15 of the FCC Rules. Operation is subject to the following two conditions: (1) This device may not cause harmful interference, and (2) this device must accept any interference received, including interference that may cause undesired operation.

This Class B digital apparatus meets all requirements of the Canadian Interference-Causing Equipment Regulations.







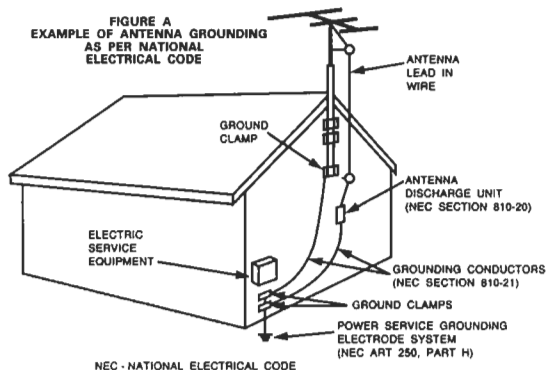

Cet appareil numérique de la classe B respecte toutes les exigences du Règlement sur le matériel brouilleur du Canada.

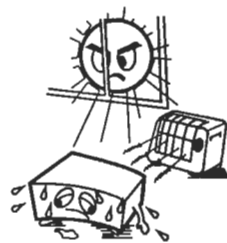
SAFETY INSTRUCTIONS

1. Read Instructions – All the safety and operating instructions should be read before the appliance is operated.
2. Retain Instructions – The safety and operating instructions should be retained for future reference.
3. Heed Warning – All warnings on the appliance and in the operating instructions should be adhered to.
4. Following Instructions – All operating and use instructions should be followed.
5. Water and Moisture – The appliance should not be used near water – for example, near a bathtub, washbowl, kitchen sink, laundry tub, in a wet basement, or near a swimming pool, and the like.
6. Carts and Stands – The appliance should be used only with a cart or stand that is recommended by the manufacturer.
- 6A. An appliance and cart combination should be moved with care. Quick stops, excessive force, and uneven surfaces may cause the appliance and cart combination to overturn.
7. Wall or Ceiling Mounting – The appliance should be mounted to a wall or ceiling only as recommended by the manufacturer.
8. Ventilation – The appliance should be situated so that its location or position does not interfere with its proper ventilation. For example, the appliance should not be situated on a bed, sofa, rug, or similar surface that may block the ventilation openings; or, placed in a built-in installation, such as a bookcase or cabinet that may impede the flow of air through the ventilation openings.
9. Heat – The appliance should be situated away from heat sources such as radiators, heat registers, stoves, or other appliances (including amplifiers) that produce heat.
10. Power Sources – The appliance should be connected to a power supply only of the type described in the operating instructions or as marked on the appliance.
11. Grounding or Polarization – Precautions should be taken so that the grounding or polarization means of an appliance is not defeated.
12. Power-Cord Protection – Power-supply cords should be routed so that they are not likely to be walked on or pinched by items placed upon or against them, paying particular attention to cords at plugs, convenience receptacles, and the point where they exit from the appliance.
14. Cleaning – The appliance should be cleaned only as recommended by the manufacturer.
15. Power Lines – An outdoor antenna should be located away from power lines.
16. Outdoor Antenna Grounding – If an outside antenna is connected to the receiver, be sure the antenna system is grounded so as to provide some protection against voltage surges and built-up static charges. Article 810 of the National Electrical Code, ANSI/NFPA 70, provides information with regard to proper grounding of the mast and supporting structure, grounding of the lead-in wire to an antenna-discharge unit, size of grounding conductors, location of antenna-discharge unit, connection to grounding electrodes, and requirements for the grounding electrode. See Figure A.
17. Nonuse Periods – The power cord of the appliance should be unplugged from the outlet when left unused for a long period of time.
18. Object and Liquid Entry – Care should be taken so that objects do not fall and liquids are not spilled into the enclosure through openings.
19. Damage Requiring Service – The appliance should be serviced by qualified service personnel when:
 - A. The power-supply cord or the plug has been damaged; or
 - B. Objects have fallen, or liquid has been spilled into the appliance; or
 - C. The appliance has been exposed to rain; or
 - D. The appliance does not appear to operate normally or exhibits a marked change in performance; or
 - E. The appliance has been dropped, or the enclosure damaged.
20. Servicing – The user should not attempt to service the appliance beyond that described in the operating instructions. All other servicing should be referred to qualified service personnel.

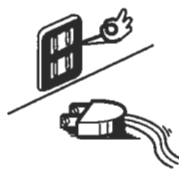

NOTE ON USE / OBSERVATIONS RELATIVES A L'UTILISATION / NOTAS SOBRE EL USO

 <ul style="list-style-type: none"> • Avoid high temperatures. Allow for sufficient heat dispersion when installed on a rack. • Eviter des températures élevées. Tenir compte d'une dispersion de chaleur suffisante lors de l'installation sur une étagère. • Evite altas temperaturas. Permite la suficiente dispersión del calor cuando está instalado en la consola. 	 <ul style="list-style-type: none"> • Keep the set free from moisture, water, and dust. • Protéger l'appareil contre l'humidité, l'eau et la poussière. • Mantenga el equipo libre de humedad, agua y polvo. 	 <ul style="list-style-type: none"> • Do not let foreign objects in the set. • Ne pas laisser des objets étrangers dans l'appareil. • No deje objetos extraños dentro del equipo.
 <ul style="list-style-type: none"> • Handle the power cord carefully. Hold the plug when unplugging the cord. • Manipuler le cordon d'alimentation avec précaution. Tenir la prise lors du débranchement du cordon. • Maneje el cordón de energía con cuidado. Sostenga el enchufe cuando desconecte el cordón d'energía. 	 <ul style="list-style-type: none"> • Unplug the power cord when not using the set for long periods of time. • Débrancher le cordon d'alimentation lorsque l'appareil n'est pas utilisé pendant de longues périodes. • Desconecte el cordón de energía cuando no utilice el equipo por mucho tiempo. 	 <ul style="list-style-type: none"> • Do not let insecticides, benzene, and thinner come in contact with the set. • Ne pas mettre en contact des insecticides, du benzène et un diluant avec l'appareil. • No permita el contacto de insecticidas, gasolina y diluyentes con el equipo.
 <ul style="list-style-type: none"> • Handle the power cord carefully. Hold the plug when unplugging the cord. • Manipuler le cordon d'alimentation avec précaution. Tenir la prise lors du débranchement du cordon. • Maneje el cordón de energía con cuidado. Sostenga el enchufe cuando desconecte el cordón d'energía. 	 <p>* (For sets with ventilation holes)</p> <ul style="list-style-type: none"> • Do not obstruct the ventilation holes. • Ne pas obstruer les trous d'aération. • No obstruya los orificios de ventilación. 	 <ul style="list-style-type: none"> • Never disassemble or modify the set in any way. • Ne jamais démonter ou modifier l'appareil d'une manière ou d'une autre. • Nunca desarme o modifique el equipo de ninguna manera.

ENGLISH

Please check to make sure the following items are included with the main unit in the carton:

- (1) Operating Instructions 1
- (2) AC Cord 1
- (3) Connecting Cord 1
- (4) AM Loop Antenna 1
- (5) FM Indoor Antenna 1
- (6) Service Station List 1

FRANCAIS

Veuillez contrôler que les articles suivants sont bien joints à l'appareil principal dans le carton:

- (1) Mode d'emploi 1
- (2) Cordon Secteur 1
- (3) Cordon de connexion 1
- (4) Antenne Cadre AM 1
- (5) Antenne FM Interieure 1
- (6) Liste des stations techniques agréées 1

ESPAÑOL

Por favor verifique asegurandose de que los siguientes articulos son empacados en la caja pero separados de la unidad principal.

- (1) Instrucciones de operación 1
- (2) Cable de alimentación 1
- (3) Cordón de concección 1
- (4) Antena AM de Cuadro 1
- (5) Antena FM Interior 1
- (6) Lista de estaciones de servicio 1

Table of characters

The characters are input in the order shown below. Use the TUNING/PRESET control 7 to select the desired characters.

Table des caractères

Les caractères sont introduits dans l'ordre indiqué ci-dessous. Utiliser la commande TUNING/PRESET 7 pour sélectionner les caractères désirés.

Tabla de caracteres

Los caracteres se ingresan en el orden que se indica abajo. Utilice el control TUNING/PRESET 7 para seleccionar los caracteres deseados.

A,B,C,D,E,F,G,H,I,J,K,L,M,N,O,P,Q,R,S,T,U,V,W,X,
 Y,Z,0,1,2,3,4,5,6,7,8,9,[,\,],^,_,!,",#,\$,%,&,' ,
 (,)*,+,-,.,/,:;, < , = , > , ? , (space)

**CONNECTIONS
CONNEXIONS
CONEXIONES**

DIRECTION OF BROADCASTING STATION
DIRECTION DE LA STATION EMETTRICE
DIRECCIÓN DE LA ESTACIÓN TRANSMISORA

Note to CATV system installer:
This reminder is provided to call the CATV system installer's attention to Article 820-40 of the NEC, which provides guidelines for proper grounding and, in particular, specifies that the cable ground shall be connected to the grounding system of the building, as close to the point of cable entry as practical.

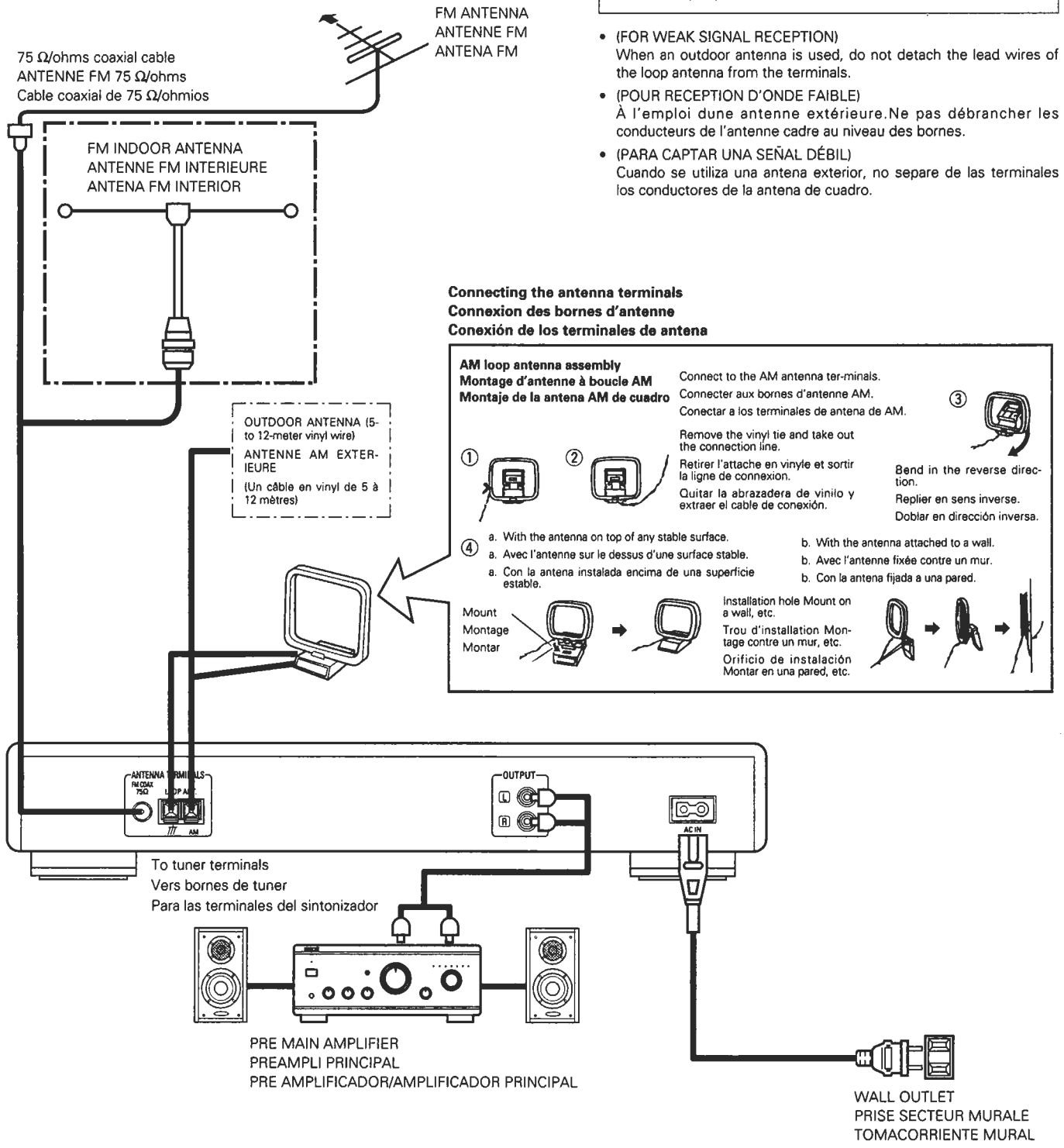

- (FOR WEAK SIGNAL RECEPTION)
When an outdoor antenna is used, do not detach the lead wires of the loop antenna from the terminals.
- (POUR RECEPTION D'ONDE FAIBLE)
À l'emploi d'une antenne extérieure. Ne pas débrancher les conducteurs de l'antenne cadre au niveau des bornes.
- (PARA CAPTAR UNA SEÑAL DÉBIL)
Cuando se utiliza una antena exterior, no separe de las terminales los conductores de la antena de cuadro.

**Connecting the antenna terminals
Connexion des bornes d'antenne
Conexión de los terminales de antena**

AM loop antenna assembly
Montage d'antenne à boucle AM
Montaje de la antena AM de cuadro

Connect to the AM antenna terminals.
Connecter aux bornes d'antenne AM.
Conectar a los terminales de antena de AM.

Remove the vinyl tie and take out the connection line.
Retirer l'attache en vinyle et sortir la ligne de connexion.
Quitar la abrazadera de vinilo y extraer el cable de conexión.

Bend in the reverse direction.
Replier en sens inverse.
Doblar en dirección inversa.

1. With the antenna on top of any stable surface.
1. Avec l'antenne sur le dessus d'une surface stable.
1. Con la antena instalada encima de una superficie estable.

2. With the antenna attached to a wall.
2. Avec l'antenne fixée contre un mur.
2. Con la antena fijada a una pared.

3. Installation hole Mount on a wall, etc.
3. Trou d'installation Montage contre un mur, etc.
3. Orificio de instalación Montar en una pared, etc.

Mount
Montage
Montar

Note:

- Please keep away AM loop antenna from the metal parts of the back panel.

Remarque:

- Eloigner l'antenne en boucle AM de toute partie métallique du panneau arrière.

Nota:

- Por favor, mantenga alejada la antena de cuadro AM, de las partes metálicas del panel posterior.

DESIGNATIONS AND FUNCTIONS OF PANEL CONTROLS

FRONT PANEL

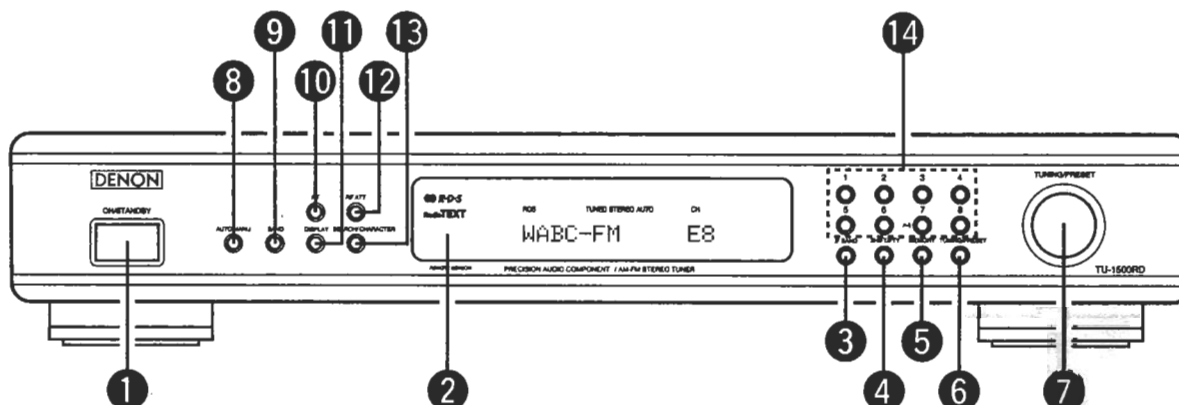

REAR PANEL

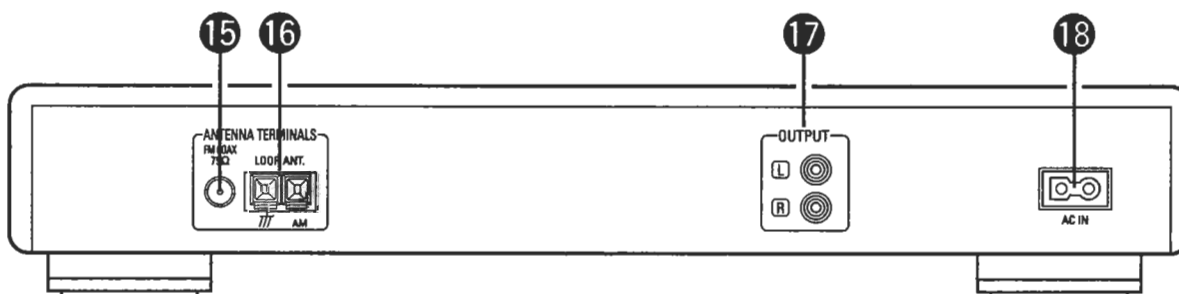

FRONT PANEL

① ON/STANDBY button

The unit works 2-3 seconds after this switch is turned on. Whenever the power switch is in the STANDBY state, the apparatus is still connected on AC line voltage. Please be sure to unplug the cord when you leave home for, say, a vacation.

② REMOTE SENSOR (Remote control sensor)

This sensor receives the infrared light transmitted from the wireless remote control unit. For remote control, point the wireless remote control unit to the sensor. Some of the functions can be operated with the remote control units included with DENON pre-main amplifiers and AV surround amplifiers.

③ IF BAND button

Use this button to select the bandwidth of the FM intermediate frequency amplifier "WIDE" or "NARROW". The wide or narrow position is indicated by the WIDE/NARROW indicator ④.

④ SHIFT/PTY button

Use this button to select the memory blocks, A (1 to 8), B (1 to 8), C (1 to 8), D (1 to 8), or E (1 to 8). For PTY search, use this button to select the program type. When writing station names, use this button to set the writing position.

⑤ MEMORY button

Frequencies and station names can be stored in the memory. When this button is pressed, the "MEMO" and "CH" indicator on the display flashes for 10 seconds. Use the SHIFT/PTY button and the preset channel buttons during this time to designate the desired preset channel.

⑥ TUNING/PRESET button

Each press of this button toggles the operation mode of the TUNING/PRESET control ⑦.

In the TUNING mode, the "TUNING" indication of the fluorescent display tube is lit. In the PRESET mode, the "PRESET" indication of the fluorescent display tube is lit.

⑦ TUNING/PRESET control

This control is used in conjunction with the TUNING/PRESET button ⑥.

CAUTION:

- Whenever the ON/STANDBY button is in the STANDBY position, the unit is still connected on AC line voltage. Please be sure to unplug the cord when you leave home for, say, a vacation.
- Noise may be generated if a near-by television set is on during MW (AM), FM broadcasting reception. The tuner should be used as far away from a television as possible.
- Effective period of memory back-up is about a month under normal temperature.

In the TUNING mode (when "TUNING" is lit in the fluorescent display tube), the reception frequency is tuned up or down. Turning the control in the clockwise direction tunes the frequency up. Turning the control in the counterclockwise direction tunes the reception frequency down.

In the PRESET mode (when "PRESET" is lit in the fluorescent display tube), the selection of the preset channel is moved up or down. The AUTO TUNING operation cannot be used when in this mode.

When writing station names, use this control to select the letters. (Refer to Page 4.)

8 Tuning mode button (AUTO/MANU)

This switches between auto and manual tuning. Auto tuning: (The "AUTO" indicator lights.) Auto tuning is used to receive FM broadcasts in stereo. Depending on the mode of the broadcast and the strength of the signal, auto tuning will automatically switch the receiving mode to stereo or monaural. During tuning, the frequency is automatically tuned up or down.

Manual tuning: The broadcast is received in monaural regardless of the mode of the FM broadcast. The reception mode should be set to "MANUAL" when there is noisy reception of stereo broadcasts (which are indicated by the lighting of "AUTO") and also when the signal is weak. During tuning, the reception frequency is tuned up or down only when the tuning mode control (marked TUNING/PRESET) is used.

9 BAND button

Selects FM or MW (AM).

10 Radio Text button (RT)

This button is used for displaying radio text messages. When this button is pressed while the station currently tuned in is offering a radio text message service, the message scrolls on the display.

This mode turns on and off each time the button is pressed.

11 Display mode selector button (DISPLAY)

This button is used to select the display mode.

REAR PANEL

15 FM antenna terminals (ANTENNA TERMINAL FM)

75-Ω/ohms coaxial cables can be connected to these terminals. For the connection procedure, see the section "CONNECTIONS". (Refer to Page 5.)

16 AM antenna terminals (ANTENNA TERMINAL AM/)

Connect the included AM loop antenna. (Refer to Page 5 for connections.) Connect with this terminal when a medium wave outdoor antenna is used.

The mode changes as follows each time the button is pressed:

- Tuning frequency
- Input character
- Programme service name (PS)
- Programme type (PTY)
- Clock time (CT)

The following may be displayed if the signals are weak or no RDS service is available. This is not a malfunction.

"NO PS"

"NO PTY"

"NO TIME DATA"

NOTE: The programme type, programme service name and clock time are not displayed in the MW (AM) band.

"NO TIME DATA" may be displayed within the first minute after a station is tuned in, but this is not a malfunction. If time data is being broadcast, the time can be displayed after one minute has passed.

12 RF attenuator button (RF ATT)

This button turns the RF attenuator on and off. When the RF attenuator is on, the "RF ATT" indicator on the display lights, and the antenna input signals are attenuated before entering the front end. Turn the RF attenuator on to receive local stations and when connecting to a cable system. Turn the RF attenuator off to receive weak signals.

This mode only functions in the FM band.

This mode setting is stored in the preset memory.

13 Search character mode button (SEARCH/CHARACTER)

This button is used for the RDS search (refer to Page 9), PTY search (refer to Page 9) and TP search (refer to Page 9, 10) operations, and to input the station name (refer to Page 8, 9).

14 Preset channel button (1-8)

Use these when presetting and recalling stations. Also use these with the SHIFT/PTY button to use a total of 40 preset channels, A (1~8), B (1~8), ... E (1~8).

17 Output terminals (OUTPUT)

Connect these to the TUNER input terminals on the pre-main amplifier.

18 AC Inlet

Connect the included AC cord here.

DISPLAY

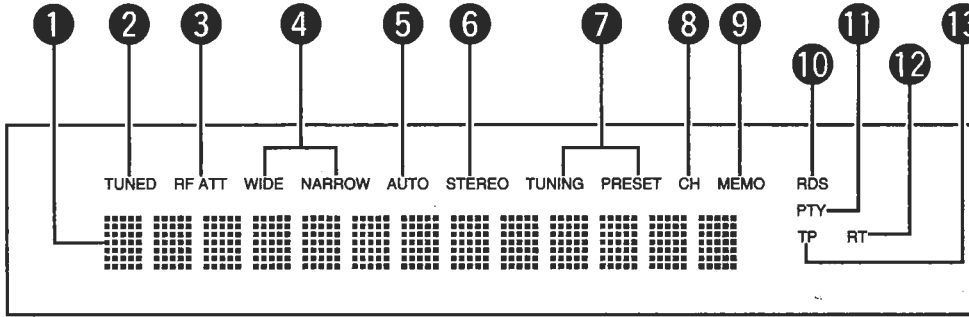

- 1 5 x 7 dot matrix display**
This displays the frequency, station name, program type, etc.
- 2 TUNED indicator**
This lights when a station is properly tuned in.
- 3 RF ATT indicator**
This lights when the RF attenuator is turned on (RF ATT 12).
- 4 WIDE/NARROW indicator**
This lights whether if amplifier stage is wide or narrow.
- 5 AUTO indicator**
This indicates the tuning mode. It lights in the auto mode, and remains off in the manual mode.
- 6 STEREO indicator**
This lights when receiving stereo broadcasts. It remains off when receiving AM broadcasts.
- 7 TUNING/PRESET indicator**
This displays the operation mode of TUNING/PRESET button 6.

- 8 CH indicator**
This lights when the preset channel number is displayed, and flashes during the auto preset memory operation and memory operation.
- 9 MEMO indicator**
This flashes for 10 seconds when the MEMORY button 5 is pressed, and flashes during the auto preset memory operation.
- 10 RDS indicator**
This lights when receiving RDS broadcasts, and flashes during the RDS search.
- 11 PTY indicator**
Flashes during the PTY search operation.
- 12 RT indicator**
This lights when the RT button 10 is pressed.
- 13 TP indicator**
This lights when receiving a station broadcasting traffic announcements and flashes during the TP search operation.

Using the Various Functions

1. Using the auto preset memory function

This function automatically stores the FM stations which can be received in the area in which the set is being used in the preset memory. Use this function so that the RDS functions can be used more effectively. Also note that the channel memories can be changed at will even after the preset stations have been stored with this function.

Operation

1. Connect the FM antenna and set it so that FM stations can be received.
2. Press the ON/STANDBY button to turn on the power while holding in the MEMORY button.
3. Searching begins automatically, and stations are stored in the preset memory in order, beginning from channel A1. (The operation automatically stops once 40 stations have been set in the memory.)

2. Storing new stations at the preset channels

The reception frequency, RDS service information, Tuning mode, RF ATT mode and input characters can be stored at the different channel memories.

When this operation is performed, the station already stored in that channel memory using the auto preset memory function is cleared.

Operation

1. Press the MEMORY button. (The CH and MEMO indicator flash.)
2. Use the SHIFT/PTY button to select the block, A to E.
3. Use buttons 1 to 8 to select the channel at which the station is to be stored.

3. Recalling preset channels

Use the following operation to recall preset channels:

Operation

1. Use the SHIFT/PTY button to select the block, A to E.
2. Use buttons 1 to 8 to select the channel at which to store the station.

4. Inputting characters

Some characters can be input (up to 8 characters). The input characters can be stored at the preset channels.

Operation

1. Press the SEARCH/CHARACTER button four times. (The cursor flashes at the first place.)

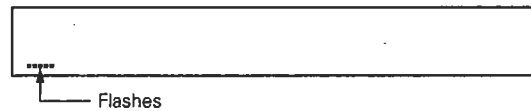

2. Use the TUNING/PRESET control to select the character for the first place. (The selected character flashes.)



- Press the SHIFT/PTY button to move the cursor to the next place.
(The cursor flashes at the second place.)

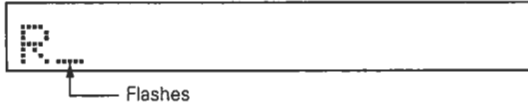

- Repeat steps 2 and 3 above to input up to 8 characters.

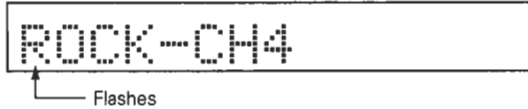

- The characters are set five seconds after the input procedure is finished. The input characters can be stored in the memory.
To keep the input characters, be sure to store them in a channel memory.

6. Clearing characters

- Recall the character you want to clear.
- Press the SEARCH/CHARACTER button 4 times until the character at the first place flashes.
- Then press the SHIFT/PTY button for at least 2 seconds.
The current character will then be cleared.

5. Initialization of the Microprocessor

In the rare event of an incorrect display or erroneous operation, the microprocessor can be initialized in order to return the system to normal. Note that the contents of the preset memory will be lost when this operation is conducted.

Operation

- Disconnect the AC power cord and then reconnect it while depressing buttons 1 and 7 of the set.
- Check that the display changes repeatedly and release your fingers from the buttons.
- Then entire memory contents will be lost and the microprocessor will be initialized.

Using the RDS Functions (for FM only)

1. RDS Search

Use this to automatically search and stop at stations offering RDS services.

Operation

- Press the SEARCH/CHARACTER button once.

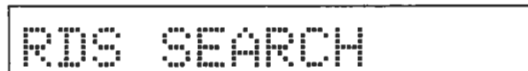

- Turn the TUNING/PRESET control clockwise or counterclockwise. (Searching begins.)



- Searching starts again when the TUNING/PRESET control is turned clockwise or counterclockwise while the RDS indicator is flashing.



- If no other RDS station is found when all the frequencies are searched, "NO RDS" is displayed.

2. PTY Search

Use this to automatically search and stop at stations broadcasting the specified programme type (PTY).

Operation

- Press the SEARCH/CHARACTER button twice.

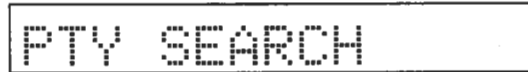

- Use the SHIFT/PTY button to select the programme type.



- Turn the TUNING/PRESET control clockwise or counterclockwise. (Searching begins.)

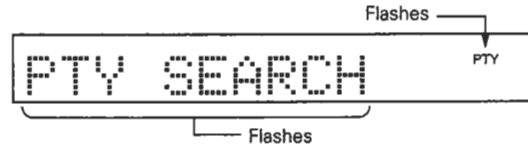

- Searching starts again when the TUNING/PRESET control is turned clockwise or counterclockwise while the PTY indicator is flashing.

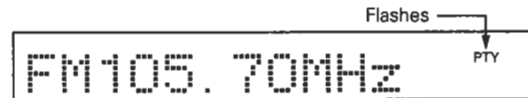

- If no other station broadcasting the designated programme type is found when all the frequencies are searched, "NO PROGRAMME" is displayed.

List of PTY (Programme Type) Displays

- | | |
|----------------|-----------------|
| 1. NEWS | 13. NOSTALGIA |
| 2. INFORMATION | 14. JAZZ |
| 3. SPORTS | 15. CLASSICAL |
| 4. TALK | 16. R+B |
| 5. ROCK | 17. SOFT R+B |
| 6. CLS ROCK | 18. LANGUAGE |
| 7. ADULT HITS | 19. REL MUSIC |
| 8. SOFT ROCK | 20. REL TALK |
| 9. TOP 40 | 21. PERSONALITY |
| 10. COUNTRY | 22. PUBLIC |
| 11. OLDIES | 31. ALERT |
| 12. SOFT | |

NOTE: 1. "ALERT" will flash on the display when the unit receives the Emergency Programme Type Code (PTY31) from an RDS station.

This feature may not operate properly if the signal from the RDS station is too weak or is subjected to interference.

2. "ALERT" cannot be selected during the PTY search operation.

3. TP Search

Use this to automatically search and stop at stations which broadcast traffic announcements (even if the station is not currently broadcasting a traffic announcement).

Operation

- Press the SEARCH/CHARACTER button three times.



- Turn the TUNING/PRESET control clockwise or counterclockwise. (Searching begins.)

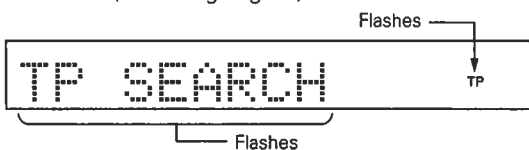

- Searching starts again when the TUNING/PRESET control is turned clockwise or counterclockwise while the TP indicator is flashing.



- If no other TP station is found when all the frequencies are searched, "NO PROGRAMME" is displayed.

4. Radio Text (RT)

When this button is pressed while the station currently tuned in is offering a radio text message service, the message scrolls on the display. (The RT indicator lights when the RT button is pressed.)



("NO TEXT DATA" is displayed if no radio text message is being broadcast.)

NOTE: 1. Since the RDS services offered differ from station to station, some RDS functions may not operate for some stations, but this is not a malfunction.

- This unit may not identify RDS stations as such if the paging station provides multiple RDS data. Tuning may not stop at such stations during the RDS search, PTY search and TP search operations.

RDS Emergency Alert Feature

The RDS Emergency Alert Feature is activated by a signal sent at the sole discretion of the RDS broadcaster. The RDS Emergency Alert Feature is included in this product for the convenience of the consumer, and is not intended to augment or replace the Official Emergency Broadcast System as administered by the Federal Communications Commission. For this reason, Nippon Columbia Co. and its Subsidiaries, refuse all Warranties, claims of merchantability or fitness, or liabilities, whether incidental, consequential or otherwise, related to, either directly or indirectly, the operation or lack of operation of this feature. This exclusion applies to any and/or all Nippon Columbia Co. Products, whether present or future, that implement, in any form or variation, the RDS Emergency Alert Feature.

TROUBLESHOOTING

Check the following before assuming there is a problem with the set.

- Are all connections proper ?
- Is the set being operated as described in the operating instructions ?
- Are the speakers and input components being operated properly ?

If the set does not seem to be operating properly, check the points listed below. If these points do not apply, the set may be damaged. Turn off the power immediately and contact your store of purchase.

Symptom	Cause	Measures	Page
Power does not turn on when ON/STANDBY button is pressed.	<ul style="list-style-type: none"> Power cord's plug is not plugged in to wall outlet. 	<ul style="list-style-type: none"> Plug the power cord in properly. 	5
Hissing noise is heard on FM broadcasts.	<ul style="list-style-type: none"> Antenna cable is not properly connected. Antenna is not pointing in the right direction. Radio waves are weak. 	<ul style="list-style-type: none"> Connect the leads properly. Point the antenna in the right direction. Install an outdoor antenna. 	5 5 5
Hissing or buzzing sound is heard on AM or FM broadcasts.	<ul style="list-style-type: none"> Noise from a TV or interference in the signals sent from the broadcast station. 	<ul style="list-style-type: none"> Turn off the TV. Change the position of the loop antenna. Install an outdoor antenna. 	5, 6 5, 6 5
Booming sound (humming) is heard in AM broadcasts.	<ul style="list-style-type: none"> Signals transmitted over the power cord are modulated by the power source frequency. 	<ul style="list-style-type: none"> Insert the plug in the opposite direction. Install an outdoor antenna. 	5 5

Technical Data (typical value)	Caractéristiques techniques (valeur caractéristique)	Datos Técnicos (Valor típico)	
<ul style="list-style-type: none"> • FM SECTION Frequency Range Antenna Terminals Usable Sensitivity S/N 50 dB Sensitivity Monoaural Stereo (μV is at 75 Ω/ohms 0 dBf = 10^{-15}W) Image Interference Ratio IF Interference Ratio AM Suppression Ratio Effective Selectivity WIDE NARROW Capture Ratio Frequency Characteristics Signal-to-noise Ratio Monoaural Stereo Total Harmonic Distortion (WIDE) Mono 1 kHz (at 75 kHz dev.) Stereo 1 kHz (at 67.5 kHz dev.) Stereo Separation 1 kHz (WIDE) • AM (MW) SECTION Frequency Range Antenna Terminals Usable Sensitivity Signal-to-noise Ratio • OTHERS Power Supply Power Consumption Dimensions (W) x (H) x (D) Net Weight 	<ul style="list-style-type: none"> • SECTION FM Plage de fréquence Bornes d'Antenne Sensibilité Pratique Sensibilité S/B à 50 dB Mono Stéréo (μV à 75 Ω/ohms 0 dBf = 10^{-15}W) Rapport d'Interférence Image Rapport d'interférence IF Rapport de Suppression AM Sélectivité Effective WIDE NARROW Rapport de Captage Caractéristique de Fréquence Rapport de Signal-à Bruit Mono Stéréo Distorsion Harmonique Totale (WIDE) Mono 1 kHz (à unedév, de 75 kHz) Stéréo 1 kHz (à unedév, de 67,5 kHz) Séparation Stéréo 1 kHz (WIDE) • SECTION AM Plage de fréquence Bornes d'Antenne Sensibilité Utilisable Rapport de signal-à-Bruit • AUTRES Alimentation Puissance absorbée Dimensions (L) x (H) x (D) Poids 	<ul style="list-style-type: none"> • SECCION DE FM Rango de frecuencia Terminales de antena Sensibilidad de uso Sensibilidad de S/N 50 dB Monoaural Estéreo (μV è a 75 Ω/ohmios 0 dBf = 10^{-15}W) Relación de interferencia de imagen Relación de interferencia de IF Relación de supresión AM Selectividad efectiva ANCHO ESTRECHO Relación de captura Características de frecuencia Relación de señal a ruido Monoaural Estéreo Distorsión armónica total (ANCHO) Mono 1 kHz (a 75 kHz dev.) Estéreo 1 kHz (a 67,5 kHz dev.) Estéreo separación 1 kHz (ANCHO) • SECCION DE AM Rango de frecuencia Terminal de antena Sensibilidad de uso Relación de señal a ruido • OTROS Fuente de energía Consumo de energía Dimensiones (W) x (H) x (D) Peso neto 	<p>87.50 MHz ~ 108.00 MHz 75 Ω/ohms Unbalanced 1.2 μV (12.8 dBf) (IHF)</p> <p>1.6 μV (15.3 dBf) 20 μV (37.2 dBf)</p> <p>80 dB</p> <p>100 dB 50 dB</p> <p>50 dB (± 400 kHz) 60 dB (± 300 kHz) 1.5 dB 20 Hz ~ 15 kHz $\pm_{1,0}^{0,5}$ dB</p> <p>82 dB (IHF) 78 dB (DIN) 78 dB (IHF) 74 dB (DIN)</p> <p>0.08 % 0.12 %</p> <p>50 dB</p>
			<p>520 kHz ~ 1710 kHz Terminal Type with Loop Ant. 18 μV 53 dB</p> <p>AC 120 V, 60 Hz 9 W 434 x 75 x 242 (17-3/32" x 2-61/64" x 9-17/32") 2.5 kg (5.5 lbs.)</p>

- Design and specifications are subject to change without prior notice.
- La conception et les spécifications sont susceptibles d'être modifiées sans préavis.
- El diseño y las especificaciones están sujetos a cambios sin previo aviso.

NIPPON COLUMBIA CO., LTD.

14-14, AKASAKA 4-CHOME, MINATO-KU, TOKYO 107-8011, JAPAN

Telephone: (03) 3584-8111

Cable: NIPPON COLUMBIA TOKYO Telex: JAPANOLA J22591

Printed in Japan 511 3289 001 ■ 804

Free Manuals Download Website

<http://myh66.com>

<http://usermanuals.us>

<http://www.somanuals.com>

<http://www.4manuals.cc>

<http://www.manual-lib.com>

<http://www.404manual.com>

<http://www.luxmanual.com>

<http://aubethermostatmanual.com>

Golf course search by state

<http://golfingnear.com>

Email search by domain

<http://emailbydomain.com>

Auto manuals search

<http://auto.somanuals.com>

TV manuals search

<http://tv.somanuals.com>