

PT-31E/PT-31W

User Manual

11-2012 / v1.1

COPYRIGHT

Copyright © Edimax Technology Co., Ltd. all rights reserved. No part of this publication may be reproduced, transmitted, transcribed, stored in a retrieval system, or translated into any language or computer language, in any form or by any means, electronic, mechanical, magnetic, optical, chemical, manual or otherwise, without the prior written permission from Edimax Technology Co., Ltd.

Edimax Technology Co., Ltd. makes no representations or warranties, either expressed or implied, with respect to the contents hereof and specifically disclaims any warranties, merchantability, or fitness for any particular purpose. Any software described in this manual is sold or licensed as is. Should the programs prove defective following their purchase, the buyer (and not this company, its distributor, or its dealer) assumes the entire cost of all necessary servicing, repair, and any incidental or consequential damages resulting from any defect in the software. Edimax Technology Co., Ltd. reserves the right to revise this publication and to make changes from time to time in the contents hereof without the obligation to notify any person of such revision or changes.

The product you have purchased and the setup screen may appear slightly different from those shown in this QIG. For more information about this product, please refer to the user manual on the CD-ROM. The software and specifications are subject to change without notice. Please visit our website www.edimax.com for updates. All brand and product names mentioned in this manual are trademarks and/or registered trademarks of their respective holders.

Notice According to GNU General Public License Version 2

This product includes software that is subject to the GNU General Public License version 2. The program is free software and distributed without any warranty of the author. We offer, valid for at least three years, to give you, for a charge no more than the costs of physically performing source distribution, a complete machine-readable copy of the corresponding source code.

Edimax Technology Co., Ltd.

Add: No. 3, Wu-Chuan 3rd Rd., Wu-Ku Industrial Park, New Taipei City, Taiwan (R.O.C.)

Tel: +886-2-77396888

Email: sales@edimax.com.tw

CONTENTS

| | |
|---|----|
| CHAPTER I: PRODUCT INFORMATION | 4 |
| 1-1 Package Contents | 4 |
| 1-2 Getting Familiar with Your New Network Camera | 4 |
| 1-3 Camera Installation..... | 7 |
| Chapter II Using Network IP Camera by Web Interface | 11 |
| 2.1 Locate the IP address of Network IP Camera | 11 |
| 2.2 Connect to IP Camera’s Web User Interface and Install ActiveX Plugin..... | 13 |
| 2.3 Viewing Live Video | 15 |
| 2.4 Client Settings | 18 |
| Chapter III Advanced Configuration..... | 20 |
| 3-1 System..... | 20 |
| 3-2 Security | 22 |
| 3-3 Network | 24 |
| 3-3-1 “General” Setup Page | 24 |
| 3-3-2 “Advanced” Setup Page..... | 26 |
| 3-3-3 Wireless | 28 |
| 3-5 Video..... | 35 |
| 3-5-1 Image Setting..... | 35 |
| 3-5-2 Video Setting | 36 |
| 3-5-3 Overlay Setting | 38 |
| 3-6 Audio..... | 39 |
| 3-7 Motion | 40 |
| 3-8 PTZ Control (RS-485)..... | 41 |
| 3-9 Event | 43 |
| 3-9-1 Settings | 44 |
| 3-9-2 Media..... | 46 |
| 3-9-3 Event Server..... | 47 |
| 3-10 Recording to SD Card | 50 |
| 3-11 SDHC | 51 |
| 3-12 Log..... | 53 |
| 3-13 Device Info | 54 |
| 3-14 Maintenance..... | 55 |
| 3-15 Language..... | 56 |
| CHAPTER IV: EDIVIEW 64-CHANNEL VIEWER | 57 |
| 4-1 EdiView Installation | 57 |
| 4-2 EdiView Interface..... | 64 |
| 4-3 Configuration | 72 |
| 4-3-1 Device | 73 |
| 4-3-2 Recording..... | 77 |
| 4-3-3 System | 80 |

| | |
|--|------------|
| 4-3-4 Schedule | 84 |
| 4-3-5 Event..... | 86 |
| 4-3-6 Security..... | 88 |
| 4-4 Video Playback..... | 91 |
| 4-4-1 Advanced Search | 93 |
| 4-4-2 Event Search | 96 |
| 4-4-3 Video Playback..... | 100 |
| Chapter V Troubleshooting | 103 |
| Federal Communication Commission Interference Statement..... | 104 |

CHAPTER I: PRODUCT INFORMATION

1-1 Package Contents

Before you start using this product, please check if there is anything missing in the package, and contact your dealer to claim the missing item(s):

- 1 x Network camera
- 1 x Power adapter
- 1 x Ethernet cable
- 1 x Mounting kit
- 1 x CD with utility software and user manual
- 1 x Quick installation guide
- 1 x Detachable antenna (PT-31W only)

1-2 Getting Familiar with Your New Network Camera

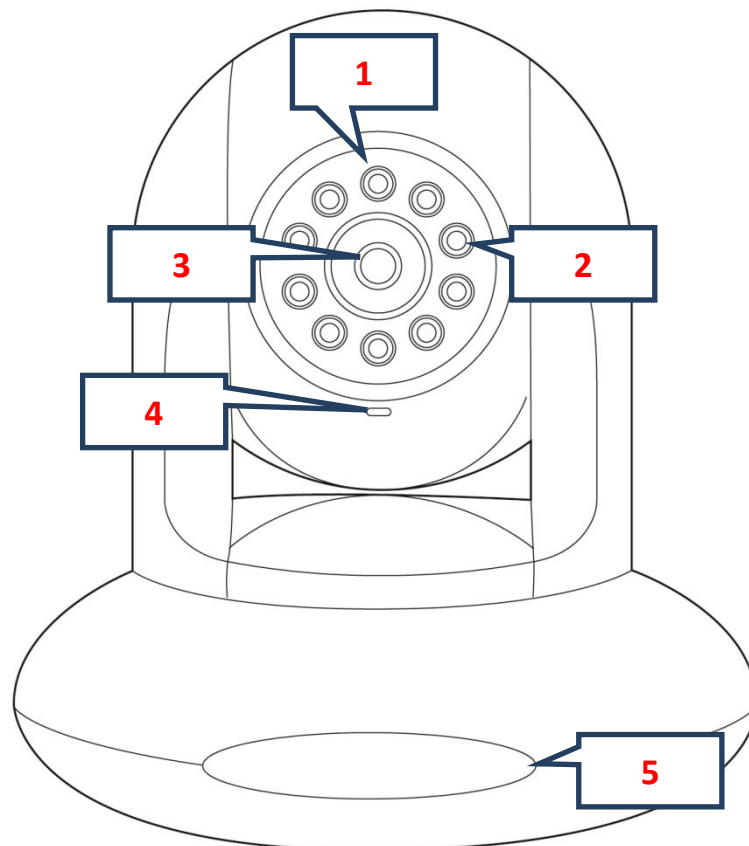

| Item | Description |
|------------------|--|
| 1 - Light sensor | Detects light level of the place where this IP camera install. |
| 2 - IR LEDs | Emits infrared light to provide light source in dark places |

| | |
|--------------------|---|
| 3 - Focus ring | If the image looks fuzzy, try to turn this focus ring clockwise or counter-clockwise to adjust focus until the image looks clear |
| 4 - Microphone | Receives voice |
| 5 - LED indicators | <p>There are 2 LED lights inside to indicate the operation of this IP camera:</p> <p>Left: Network activity LED</p> <p>On: Ethernet cable connected Off: Ethernet cable disconnected Flash: Transferring data</p> <p>Right: Power LED</p> <p>On: IP camera is switched on Off: IP camera is switched off</p> <p>Please note: These LEDs can be switched off regardless the operation status of IP camera in IP camera's configuration menu. This will be helpful if you don't want other people to know the operation status of this IP camera.</p> |

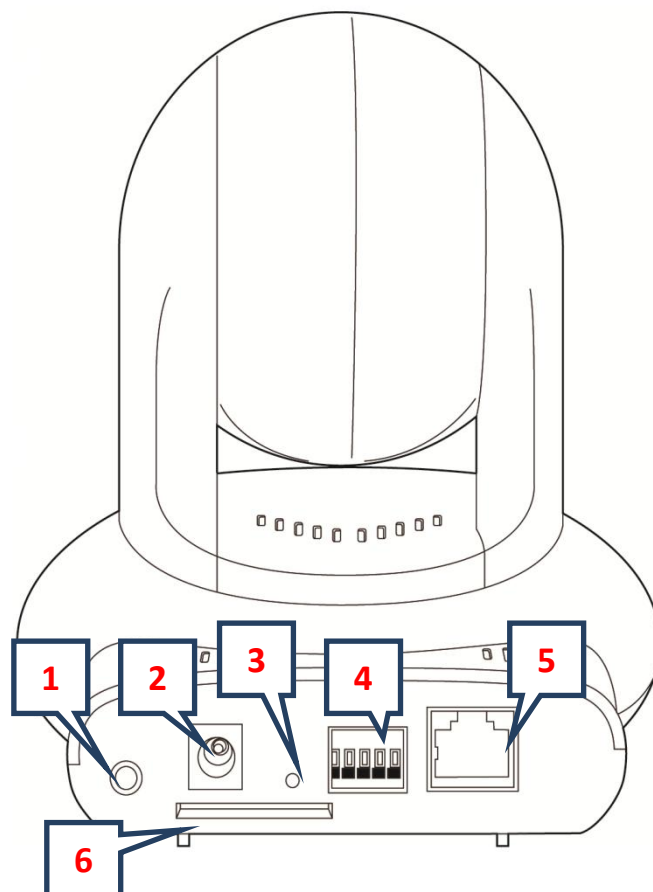

PT-31E

| Item | Description |
|---------------|--|
| 1 - Audio out | Connects to external audio amplifier to output voice. Use 3.5mm audio cable. |
| 2 - DC12V | Connect to DC power adapter output |

| | |
|----------------------|--|
| 3 - RESET | When the IP camera is not functioning properly, you can use a pen or similar object to press this reset button to reset the IP camera. You can also press and hold this button for more than 5 seconds to clear all settings of IP camera, include administrator password. |
| 4 - DI/DO connectors | For external sensor and alarm. WARNING: DO NOT CONNECT POWERED CABLE! |
| 5 - ETHERNET | Connect to your local area network by Ethernet cable. |
| 6 – SD card slot | Inserts SD card for video recording. Maximum 32GB of SD-HD card supported. |

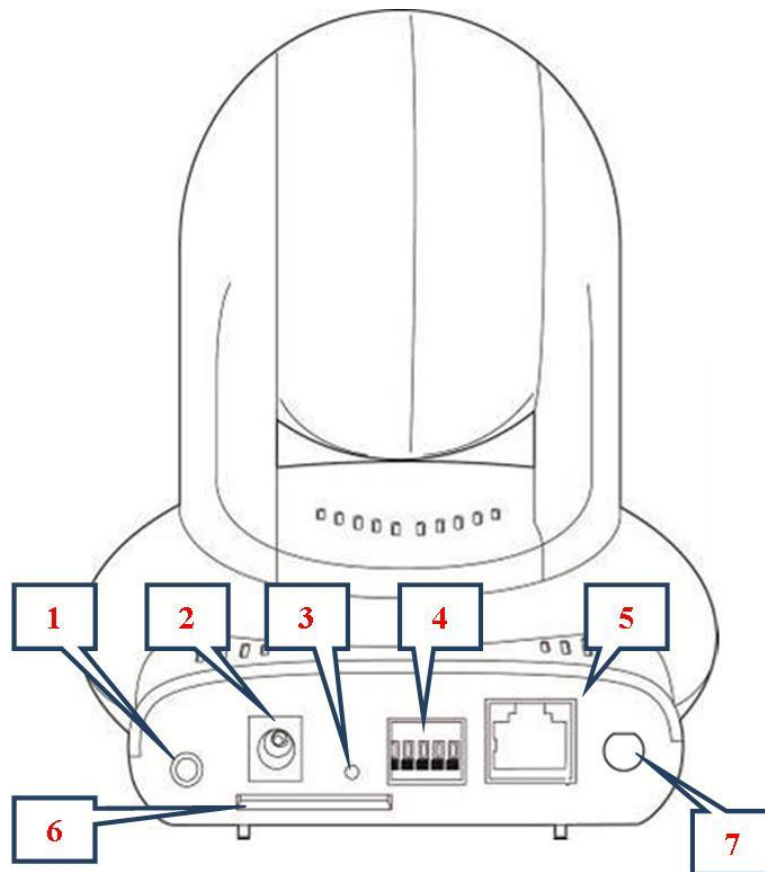

PT-31W

| Item | Description |
|----------------|--|
| 1 - Audio out | Connects to external audio amplifier to output voice. Use 3.5mm audio cable. |
| 2 - DC12V | Connect to DC power adapter output |
| 3 - WPS/ RESET | RESET: When the IP camera is not functioning properly, you can use a pen or similar object to press this reset button to reset the IP camera. You can also press and hold this button for more than 5 seconds to clear all settings of IP camera, include administrator password. WPS: When you want to connect Wi-Fi AP easy. Please both press and hold this button and AP's WPS button more than 1 |

| | |
|--------------------------------------|--|
| | second. IP camera will connect AP and set value during 5 ~10 seconds. |
| 4 - DI/DO connectors | Digital input / output dry contacts. Connects to external peripherals by wire. See next page for pin definitions. WARNING: DO NOT CONNECT POWERED CABLE! |
| 5 – ETHERNET | Connect to your local area network by Ethernet cable. |
| 6 - SD card slot | Inserts SD card for video recording. Maximum 32GB** of SDHD card supported. |
| 7 – Connector for detachable antenna | Connect the detachable antenna when wireless connection is required. |

DI/DO PIN ASSIGNMENT

| Item | Description |
|------|-------------------|
| GND | Signal ground |
| DO | Digital Output #1 |
| DI1 | Digital Input #1 |
| DI2 | Digital Input #2 |

To insert or release a wire, press the button of the PIN you wish to insert or release.

1-3 Camera Installation

Please follow the proceeding instructions to set up your new network camera. If you wish to place this network camera on a table, please skip step 1 to 6.

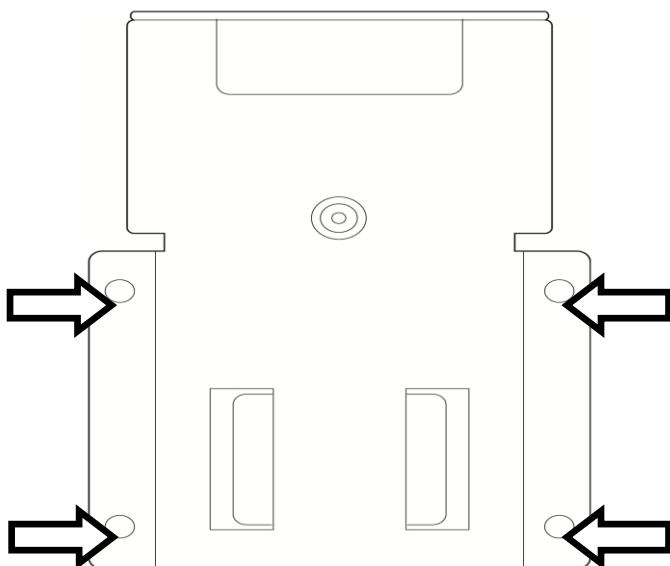

Step 1:
Screw mounting plate A on the wall via the 4 holes indicated by the arrows.

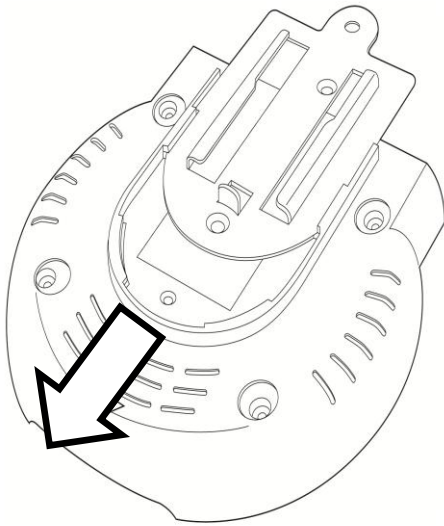

Step 2:

Insert mounting plate B into the slot at the bottom of the network camera.

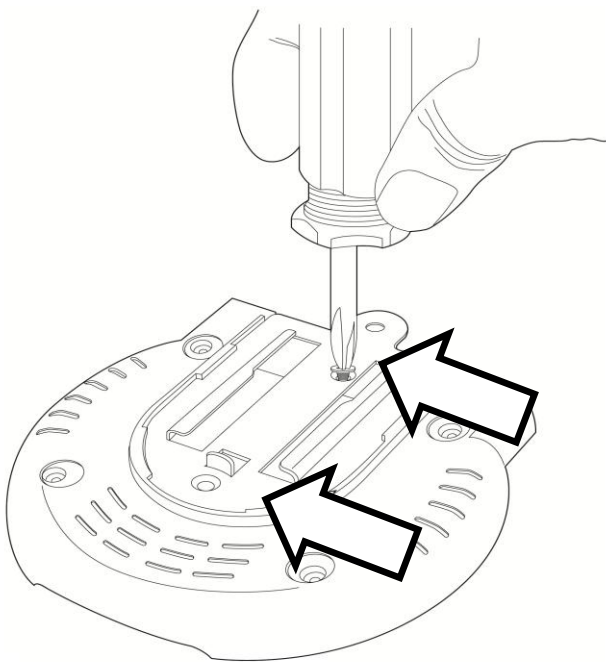

Step 3:

Screw mounting plate B to the network camera via the 2 holes indicated by the arrows.

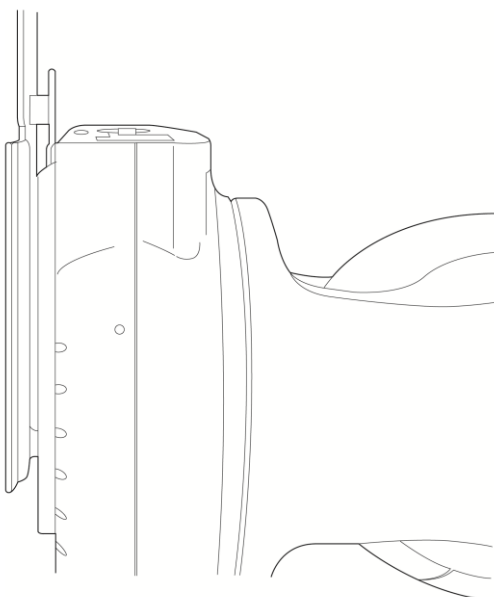

Step 4:

Mount the network camera on to the wall.

Step 5:

Screw mounting plate A and B together via the hole indicated by the arrow.

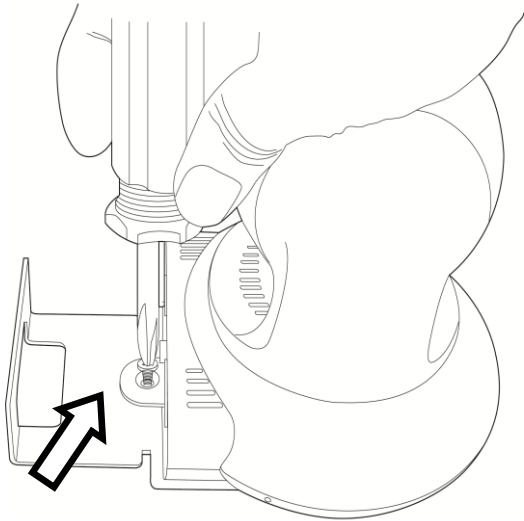

Step 6:

When mounted on the wall, the cables can pass through mounting plate A as in the picture.

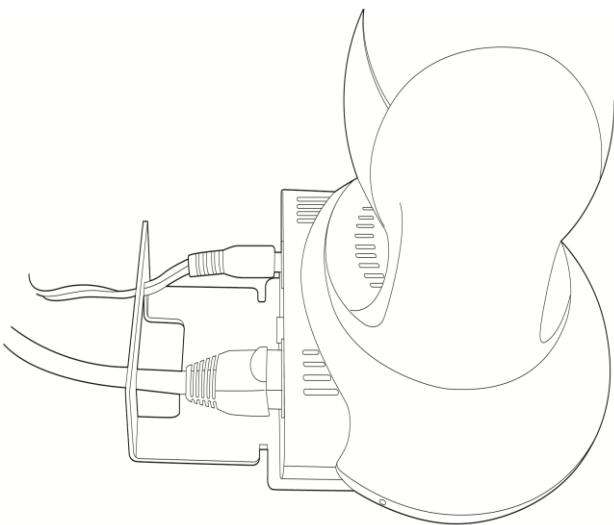

Step 7:

Connect an Ethernet cable to the network camera via the Ethernet port.

Note: PT-31E (PoE model) supports the IEEE 802.3af PoE standard. It can be powered via the Ethernet cable when connected to a PoE switch.

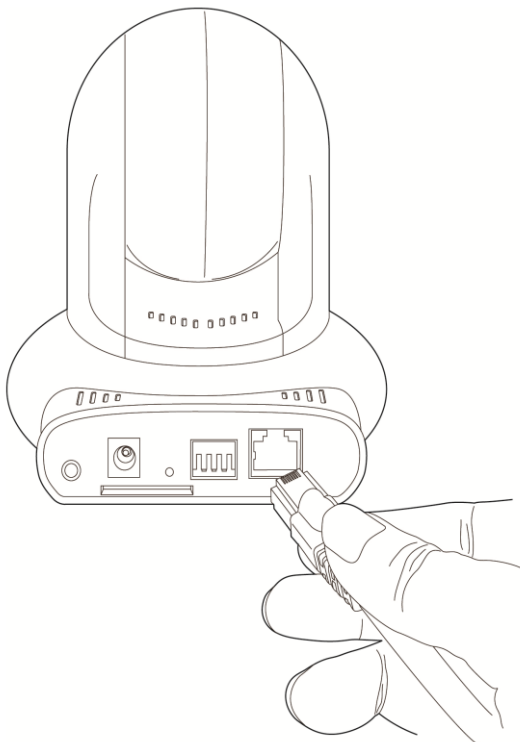

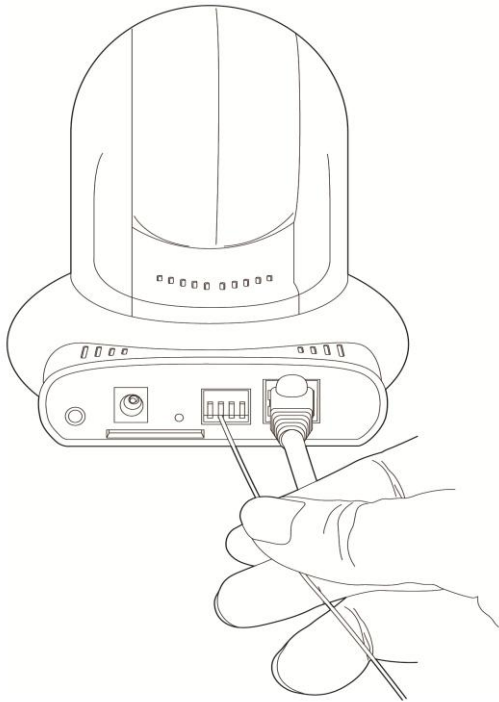

Step 8:

Insert the DI/DO signal cable(s) into the DI/DO port. If you do not have DI/DO accessories, you can skip this step.

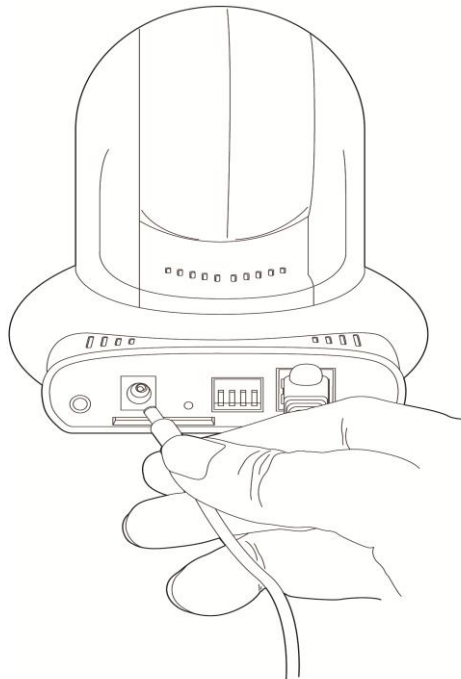

Step 9:

Connect the power adapter to the network camera, then plug the power adapter into a wall socket. The camera's LED lights should light up after a few seconds, and the camera will test its pan and tilt motor within 1 minute. Please do not obstruct the network camera while it is testing its pan and tilt motor.

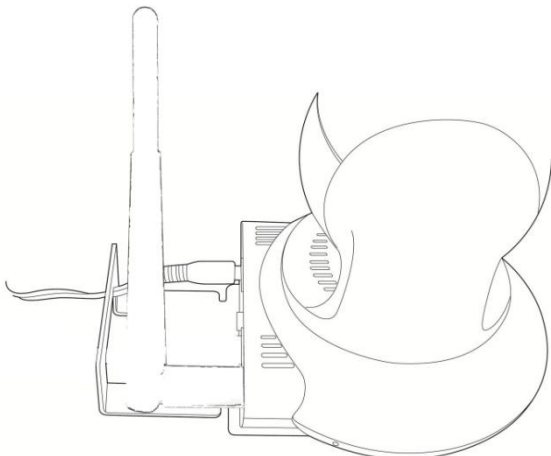

Step 10:

If it needs to set up wireless connection, please attach the wireless antenna to the IP camera and configure through wired connection. (PT-31W only)

Chapter II Using Network IP Camera by Web Interface

2.1 Locate the IP address of Network IP Camera

You can use your new Network IP Camera by its web user interface via web browser. Currently the viewing system requirement for Network IP camera is:

- OS: Microsoft Windows XP/Vista/7
- Browser: IE7, 8, 9
- Cell phone: 3GPP player

Note: For best viewing experience we recommend that you use Microsoft Windows Internet Explorer 7, 8, or 9 .

By default, the network camera automatically obtains an IP address from the DHCP server on your local network. Check your DHCP server's IP address lease table to find the network camera's IP address, or use the EdiView Finder utility included in the CD.

1. Insert the CD into your CD-ROM drive. When the wizard appears, click "Setup Utility" to install the "EdiView Finder" software.



Note: The contents of the CD-ROM can also be downloaded from the Edimax website: <http://www.edimax.com/en/index.php>

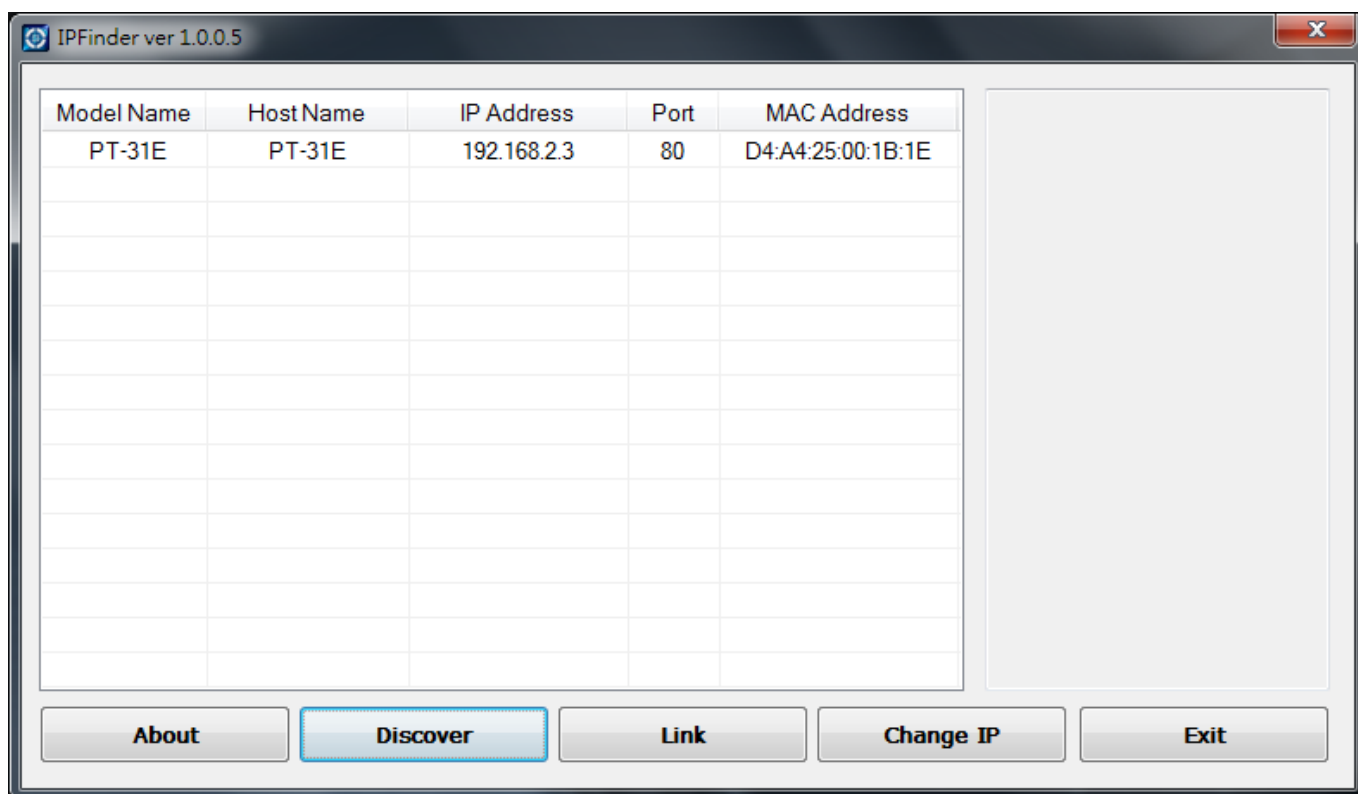

2. After the installation is complete, double-click the “EdiView_Finder” icon to execute the application.
3. Press ‘Discover’ button to search for all IP Cameras on your local network (make sure all IP Cameras are powered on and connect to local network first). When you find any IP Camera, you can double click on it or click ‘Link’ button to connect to it by your web browser.

If you need to change a certain IP Camera’s IP address, you can also click on the IP Camera you wish to change IP address, then click ‘Change IP’ button to change select IP Camera’s IP address setting.

If you no longer need to use this utility, click ‘Exit’ button to close it.

Please note:

If you have several network connections, such as “Wireless Function”, please disable the “Wireless Functions” or/and other network connections that is not connected to IP camera, or IPFinder may fail to search IP camera!

2.2 Connect to IP Camera's Web User Interface and Install ActiveX Plugin

When you know the IP address of IP Camera, you can connect to it by Internet Explorer web browser by entering its IP address in address bar. The use login screen will appear when you get connected:

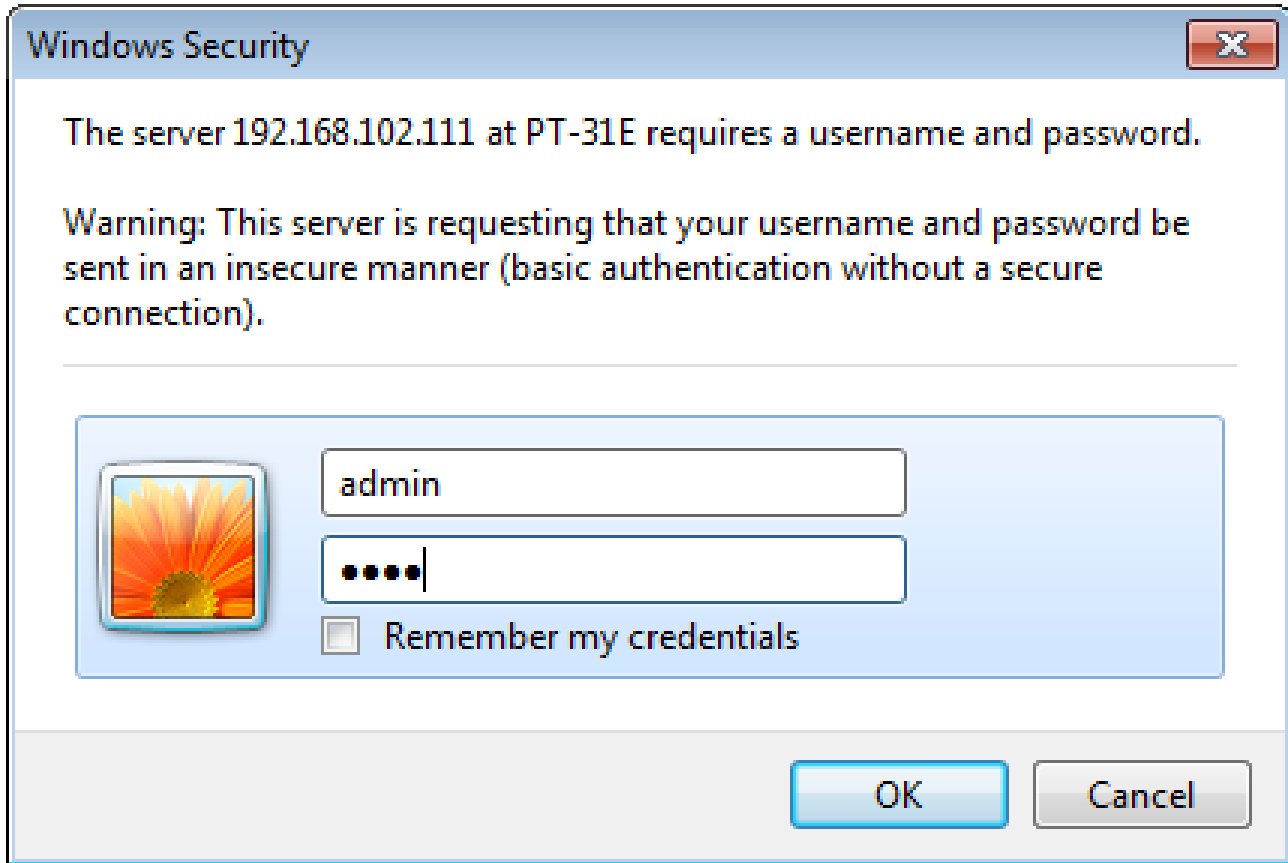

IP Camera's administrator username is 'admin' (lower case) and password is '1234' by default. Click 'OK' button or press 'ENTER' key on your keyboard when you finish entering username and password.

When you connect to IP Camera for the first time, you'll see the following message. This message prompts you that you need to install ActiveX plugin before you can see the video from IP Camera.

For IE 8 and earlier version:

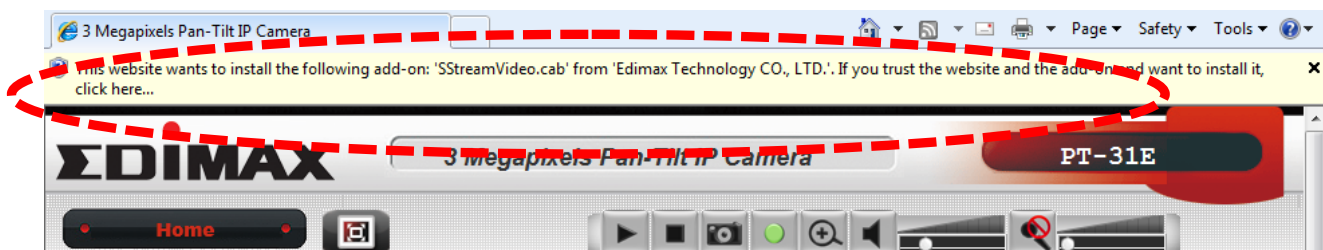

Right click the indication bar and click:

"Install This Add-on for All Users on This Computer..." to install ActiveX plugin.

For IE 9:



Click 'Install' button located at the bottom of IE to install ActiveX plugin.

If you're prompted that:

'Windows Firewall has blocked some features of this program'

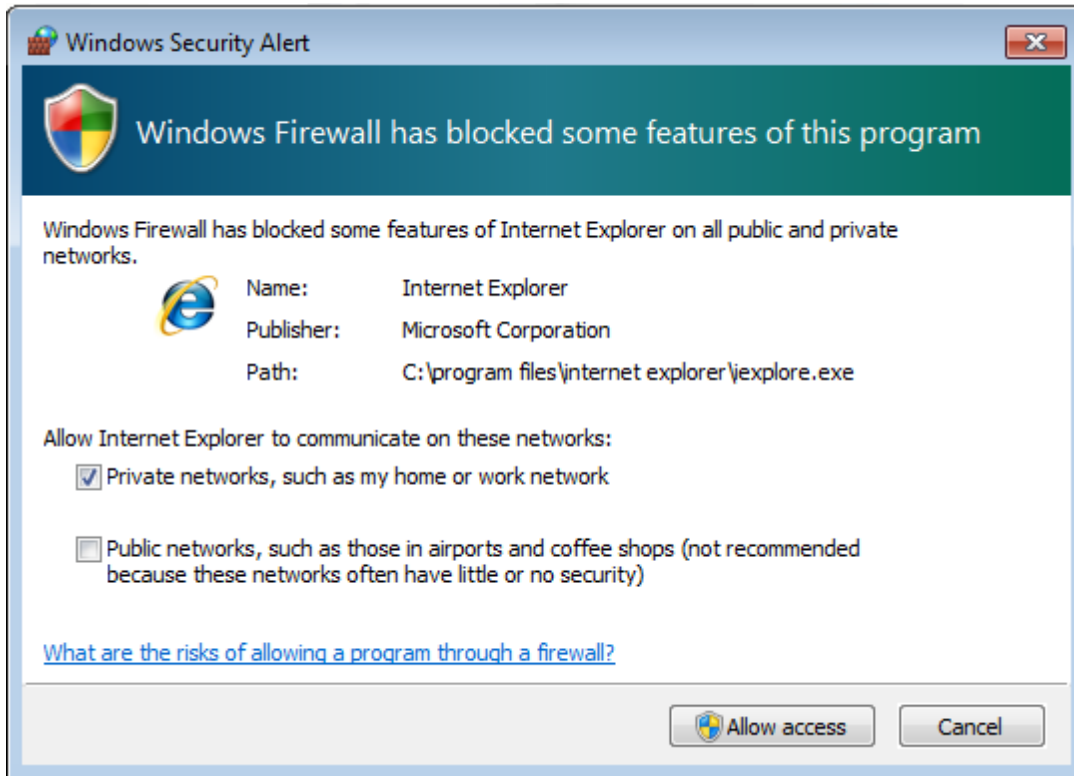

Click 'Allow access', or IP Camera will not be able to function properly.

When you're installing Internet Explorer plugin, you may also be prompted that if you want to allow changes to be made to your computer:

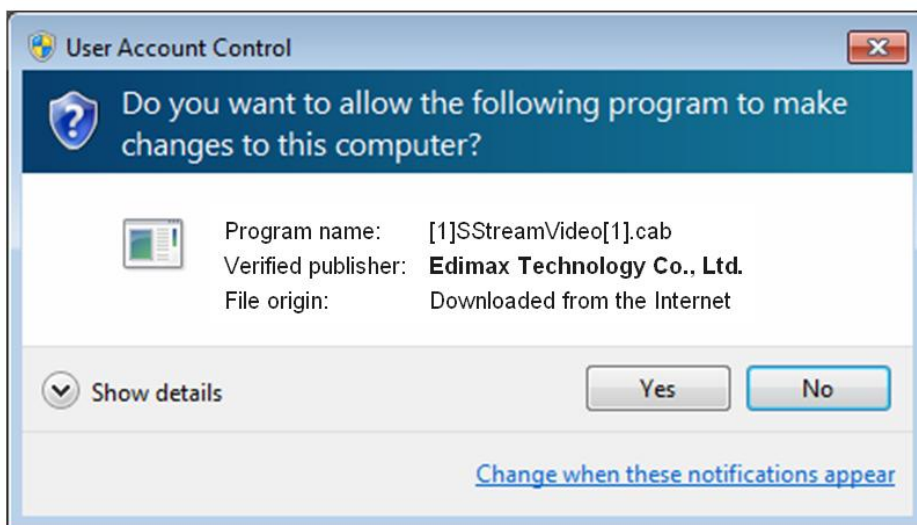

Click 'Yes' to allow changes.

After ActiveX plugin is installed, you should be able to see the video stream from camera.

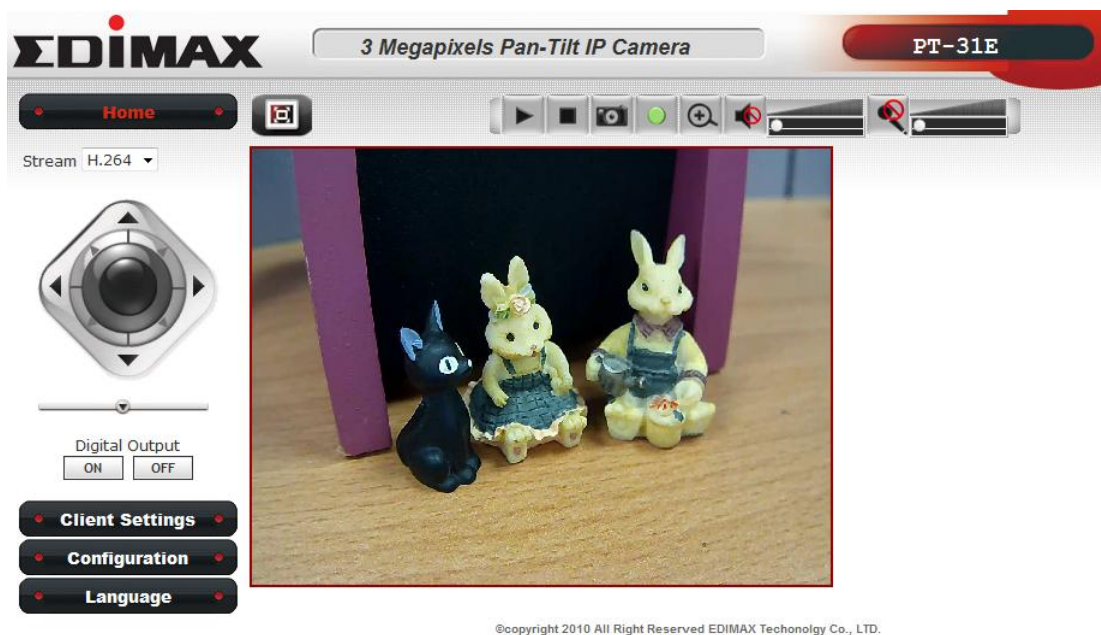

NOTE:



If this is the first time you use this IP Camera, you can refer to chapter 2.4 for instructions on Setup Wizard, which will guide you to complete the software setup of your new IP Camera.



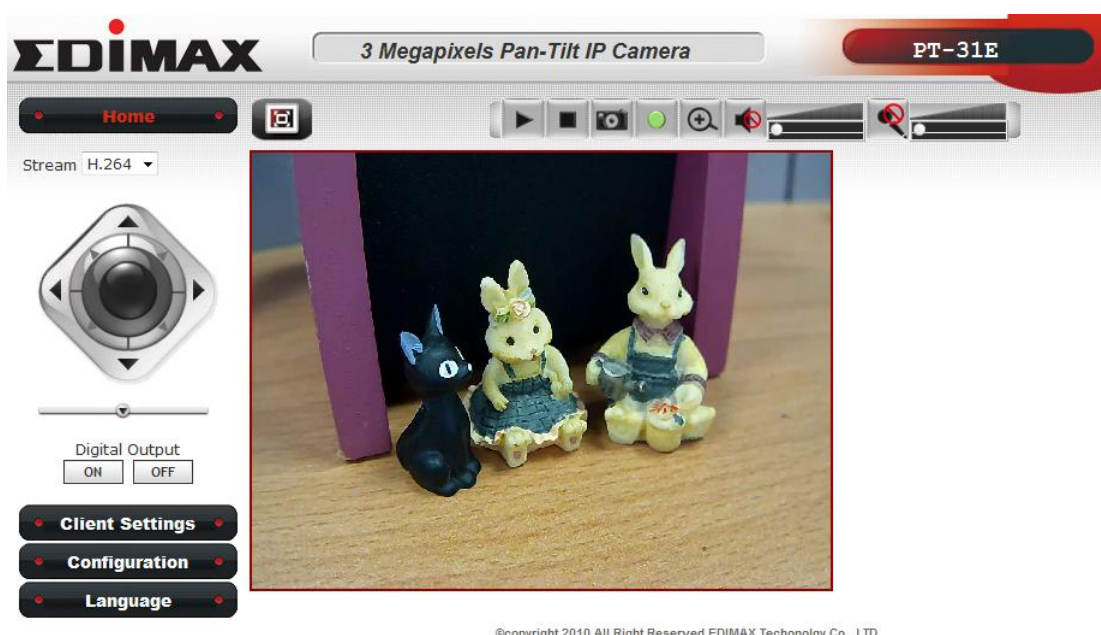

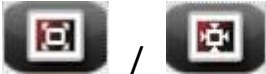

2.3 Viewing Live Video

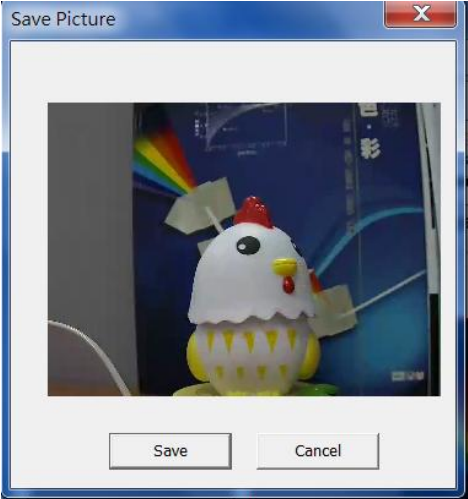
After ActiveX control is installed, you can view IP camera's video by web browser. Just connect to IP camera by web browser and login, then you can see live video from IP camera:



There are various controls on web page, here are descriptions of every control item:

| Item | Description |
|---|--|
| 'Home' button | This button is visible in all setup pages of IP camera, and you can go back to live video view by clicking this button when you're in other page. |
| Stream | Select video stream type: H.264 or MJPEG. H.264 required less network bandwidth and this will help when network connection is slow. |
| Digital Output (ON / OFF) | Switch digital output interface on or off. |
| Client Settings | Open 'Client Setting' menu. |
| Configuration | Open 'Configuration' menu. |
| Language | Open language menu, you can switch web interface to other language. Available languages: English, Simplified Chinese, Traditional Chinese |
| Original size / Fit screen  | Switches live image view between original size (full size: 3M pixels) and fit screen (smaller size). If you want to see video in detail, switch to original size. If your computer monitor's resolution is not enough and you want to see full image view, switch to fit screen and image size will adjust automatically. |
| 'Connect' button  | Start live video view. |
| 'Disconnect' button  | Stop live video view. |
| 'Snapshot' button | Take a snapshot or camera video and save image file on your computer. When you click this button, a new window will appear:  |

| | |
|--|--|
| | <p>Click 'Save' button when you see the image you wish to save, and you'll be prompted to indicate the folder on your computer to save image file. If you changed your mind and don't want to save image file, click 'Cancel'.</p> |
| <p>'Start Video Record' button</p>  | <p>Click this button to record video and save video file on your computer. You'll be prompted to indicate the folder on your computer to save video file.</p> |
| <p>'Enable Digital Zoom' button</p>  | <p>This function will enlarge video view digitally from 1X to 10X, so you can see objects in video in detail.</p> <p><i>Please note: that digital zoom uses computer algorithm to enlarge the video and some details may lost. If you need to focus on detail of specific objects in video view, please use optical zoom ring on lens set of IP camera.</i></p> |
| <p>Enable / Disable mute button</p>  | <p>When mute is enabled (), you will not hear the voice from IP camera; If you want to hear voice from IP camera, click this button to disable mute ().</p> <p>You can drag the slide bar () beside enable/disable mute button to adjust audio playback volume.</p> |
| <p>Start / Stop talk Button</p>  | <p>Start or stop playing your voice through IP camera's audio output. When talk is stopped, people at IP camera will not hear you.</p> <p>Please note: you need a microphone connected to your computer, and computer's mixer setting must enable microphone recording, or nothing will be outputted by IP camera.</p> |

2.4 Client Settings

In 'Client Settings' menu, you configure basic IP camera settings like data transfer protocol and data storage folder.

To access 'Client Settings' menu, click 'Client Settings' button on the left.



The following screen will appear:

The screenshot shows the 'Client Settings' configuration page. The title 'Client Settings' is at the top left. Below it are two main sections: 'Protocol Option' and 'Storage Option'. The 'Protocol Option' section has two radio buttons: 'RTSP' (selected) and 'HTTP'. The 'Storage Option' section has a 'Folder:' text box containing 'C:\Recording' and a 'Browse' button. Below that is a 'Prefix:' text box containing 'CLIP'. At the bottom of the 'Storage Option' section is a checkbox labeled 'Add date and time suffix to file name', which is currently unchecked. At the bottom left of the page is an 'Apply' button.

Here are the descriptions of every setup item:

| Item | Description |
|---------------------------------------|---|
| RTSP | Select this option to use RTSP (Real-Time Streaming Protocol) to transfer video data. |
| HTTP | Select this option to use HTTP (Hyper-Text Transfer Protocol) to transfer video data. If you don't know which one you should use, select 'RTSP'. |
| Folder | Select a folder on your computer to save recorded video. Click 'Browse' button and you'll be prompted to select a folder. |
| Prefix | When saving video files, the characters you typed in 'Prefix' field will be used as leading characters of video file's name. For example, the default setting of 'Prefix' is 'CLIP', and video file's named will be 'CLIPxxxx', where xxxx is a 4-digit serial number. |
| Add date and time suffix to file name | Check this box to add data and time to the ending part of video file's filename, so you can see the date and time the video file is created directly from its filename. |

When you finish with above settings, click 'Apply' button to save changes.

Chapter III Advanced Configuration

If you wish to configure IP camera's settings, you can access IP camera's 'Configuration' menu, which provides various kinds of system setting.

To access configuration menu, click 'Configuration' button on the left.



©copyright 2010 All Right Reserved EDIMAX Technology Co., LTD.

The 'Configuration' submenu will appear, please pick a setup item you wish to configure.

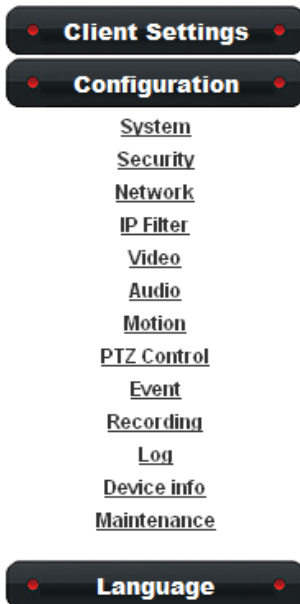

3-1 System

In this menu, you can configure basic IP camera settings like hostname and time.

Here are the descriptions of every setup item:

| Item | Description |
|--------------------------------|--|
| Host Name | Input the IP camera's hostname here, it can be any meaningful words or characters that will help you to identify this IP camera. You can use IP camera's installation location as host name, and this will help you to identify IP camera when you have many IP cameras installed. |
| Indicator LED | The LED lights located at the back of IP camera is switched on by default. But, if you don't want other people to know the status of this IP camera (so they will know this IP camera is operating etc.), you can select 'Off' and LED lights will be switched off. |
| Timezone | Select the time zone of residence from dropdown menu to keep correct date and time. |
| Daylight Saving | If the area you live uses daylight saving, check this box; otherwise do not check this box to keep time correct. |
| Keep the current date and time | Select this option and date / time setting will not be changed when you click 'Apply' in the page. You can check 'Camera Date and Time' item in this page to know IP camera's current date and time setting. |
| Synchronize with computer time | Select this item and IP camera will use your computer's time as its time. |
| Synchronize with NTP Server | Select this item and IP camera will keep its date and time setting synchronized with specified time server (NTP server). Please input NTP server's IP address or host name in 'NTP Server Address' field, and select time update interval from 'Update Interval' dropdown menu. |

| | |
|--------------|---|
| | <i>Please note that if this IP camera can't access Internet, you must have a time server on local area network, or set the time manually.</i> |
| Set Manually | Set IP camera's date and time manually. Please set current date and time by 'Date' and 'Time' dropdown menu. |

When you finish with above settings, click 'Apply' button to save changes.

3-2 Security

In this menu, you can configure IP camera's login account.

There are three kinds of account:

- Administrator (Can view IP camera's video and make changes of camera setting)
- User (Can view IP camera's video and see settings, but can't make any change)
- Guest (Can view IP camera's video only)

There can be multiple users, but only one administrator is allowed, and you can't change administrator's user name (it will always be 'administrator').

Security

Administrator

Password

Retype Password

* Administrator password length must be between 4 and 8 characters.

Account List

Account List

User Name

Password

Retype Password

Authority User

* User name length must be between 1 and 32 characters.
 * Password length must be between 4 and 8 characters.

Here are the descriptions of every setup item:

| Item | Description |
|--|--|
| Password / Retype Password (Administrator) | Input administrator's new password in both 'Password' and 'Retype Password' field, and click 'Modify' button to change administrator's password. <i>Please note: Don't forget administrator's password! Or you'll need to reset IP camera's all settings to get administrator's password recovered.</i> |
| Account List | Here lists all users existed in IP camera. If you want to remove one user, click it in the list, and then click 'Remove' button. <i>If no user is existed, 'New Account' message will be shown here.</i> |
| User Name | Input new user's username here. User name must be greater than 1 character and less than 32 characters. |
| Password / Retype Password | Input this user's password in both 'Password' and 'Retype Password' field. |
| Authority | To define this user's access privilege, select 'User' or 'Guest' in dropdown menu. When you finish inputting new user's information, click 'New' button to create a new user. |

3-3 Network

You can configure the network camera's general and advanced network settings here.

3-3-1 "General" Setup Page

Set up IP address for this IP camera. This IP camera supports both IPv4 and IPv6 IP address.

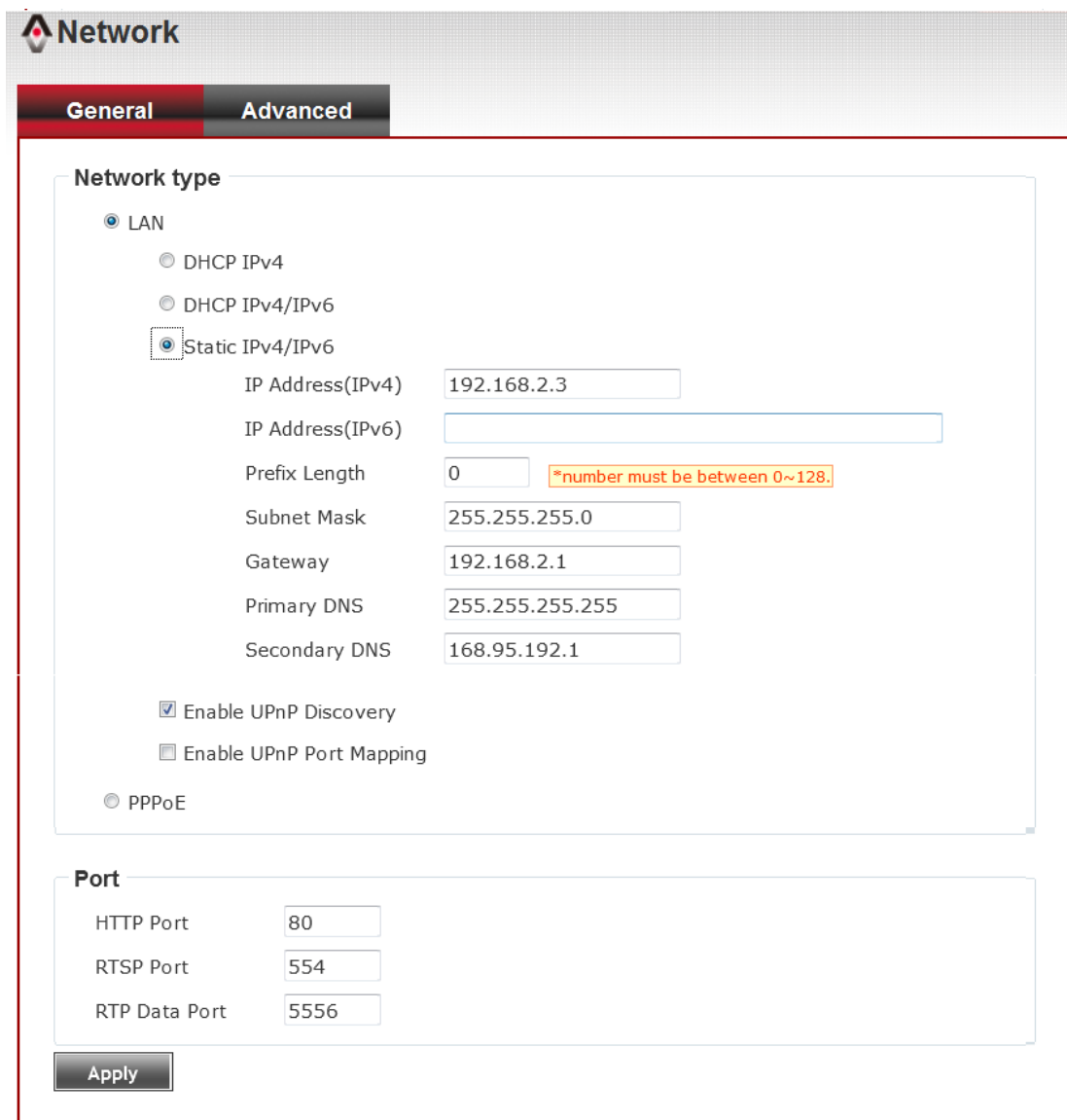

The screenshot shows the 'Network' configuration page with the 'General' tab selected. Under 'Network type', the 'Static IPv4/IPv6' option is chosen. The IP Address (IPv4) is set to 192.168.2.3, and the Subnet Mask is 255.255.255.0. The Gateway is 192.168.2.1, Primary DNS is 255.255.255.255, and Secondary DNS is 168.95.192.1. The 'Enable UPnP Discovery' checkbox is checked, and 'Enable UPnP Port Mapping' is unchecked. The 'Port' section shows HTTP Port as 80, RTSP Port as 554, and RTP Data Port as 5556. An 'Apply' button is at the bottom left.

Here are the descriptions of every setup item:

| Item | Description |
|------|---|
| LAN | Select this option to assign an IP address to LAN port (or obtain an address from DHCP server automatically). |

| | |
|-----------|---|
| | <p>Available options are:</p> <p>DHCP IPv4: Obtain an IPv4 IP address from DHCP server on LAN automatically.</p> <p>DHCP IPv4 / IPv6: Obtain both IPv4 and IPv6 address from DHCP server on LAN automatically.</p> <p>Static IPv4 / IPv6: Assign an IPv4 / IPv6 address to IP camera manually. If you don't have a DHCP server on your local area network, you must use this option to specify an IP address.</p> <p>IP Address(IPv4): Input IPv4 IP address*</p> <p>IP Address(IPv6): Input IPv6 IP address*</p> <p>Prefix Length: Input IPv6 IP address' prefix length (0-128)</p> <p>Subnet Mask: Input subnet mask</p> <p>Gateway: Input gateway address</p> <p>Primary DNS: Input DNS server's IP address</p> <p>Secondary DNS: Input backup DNS server's IP address, you can leave this field blank.</p> <p>* You can leave this field blank, if you only wish to use IPv4 or IPv6 IP address.</p> <p>Enable UPnP Discovery: Check this box to enable other devices on network to discover the presence of this IP camera by UPnP. It's recommended to enable this function.</p> <p>Enable UPnP Port Mapping: When UPnP is enabled, check this box to enable UPnP's port mapping.</p> |
| PPPoE | <p>Select this option to use PPPoE to connect to network. You have to input PPPoE username and password assigned by network operator to get connected.</p> |
| HTTP Port | <p>Input IP camera's web connection port number here. When this port number is changed, you need to change web browser's port number you used to connect to IP camera.</p> <p>For example, IP camera's IP address is 192.168.2.3, and if you changed HTTP port number to 82, please input 'http://192.168.2.3:82' in web browser's address bar to access IP</p> |

| | |
|---------------|---|
| | camera's web configuration interface. |
| RTSP Port | Input RTSP port number. When this port number changes, you must change corresponding settings in external network devices (NVR or CMS software) so they can receive this IP camera's video. |
| RTP Data Port | Input RTP data port number here. |

When you finish with above settings, click 'Apply' button to save changes.

3-3-2 "Advanced" Setup Page

You can setup advanced network settings in this page. This page is intended for advanced settings only, and this IP camera will work fine even you don't make any changes to this page.

Network

General **Advanced**

Multicast

Enable Multicast

Bonjour

Enable Discovery

Qos

Enable Qos

DDNS

Enable DDNS

HTTPS

Enable HTTPS

HTTPS Port

Apply

Here are the descriptions of every setup item:

| Item | Description |
|-----------|--|
| Multicast | <p>Enable video multicast:</p> <p>Multicast</p> <p><input checked="" type="checkbox"/> Enable Multicast</p> <p>Multicast Group Address <input type="text" value="232.128.1.99"/> * 232.0.0.0~232.255.255.255</p> <p>Multicast Video Port <input type="text" value="5560"/></p> <p>Multicast RTCP Video Port <input type="text" value="5561"/></p> <p>Multicast Audio Port <input type="text" value="5562"/></p> <p>Multicast RTCP Audio Port <input type="text" value="5563"/></p> <p>Multicast TTL <input type="text" value="15"/> *number must be between 1~255.</p> <p>Multicast Group Address: Input multicast group address here, must be an address between 232.0.0.0 to 232.255.255.255.</p> <p>Multicast video port: Input port number for video multicast here.</p> <p>Multicast RCTP video port: Input port number for RCTP video here.</p> <p>Multicast audio port: Input port number for audio here.</p> <p>Multicast RCTP audio port: Input port number for RCTP audio here.</p> <p>Multicast TTL: Input TTL value for multicast here.</p> |
| Bonjour | <p>If you're using MacOS and you have Bonjour installed, you can use it to discover this IP camera.</p> |
| QoS | <p>Enable QoS to improve the data transfer priority of this IP camera (Your local area network must support QoS).</p> <p>Qos</p> <p><input checked="" type="checkbox"/> Enable Qos</p> <p><input type="radio"/> Video</p> <p><input checked="" type="radio"/> Audio DSCP <input type="text" value="0"/> *number must be between (0~63).</p> <p><input type="radio"/> Both</p> <p>You can select Video / Audio's QoS DSCP value (0 to 63), or both video and audio.</p> |
| DDNS | <p>Enable DDNS support if your ISP assigns dynamic IP address to</p> |

| | |
|-------|---|
| | <p>you. You must register a dynamic IP service first. Currently this IP camera supports Dyndns, TZO and No-ip dynamic IP service..</p> <p>DDNS</p> <p><input checked="" type="checkbox"/> Enable DDNS</p> <p>Provider <input type="text" value="DynDNS.org"/></p> <p>Host Name <input type="text"/></p> <p>User Name <input type="text"/></p> <p>Password <input type="text"/></p> <p>Provider: Select dynamic IP service provider.</p> <p>Host Name: Input the host name you obtained from dynamic IP service provider.</p> <p>User name: Input user name used to login dynamic IP service provider.</p> <p>Password: Input the password used to login dynamic IP service provider.</p> <p>*The user name and password should be under 16 characters.</p> |
| HTTPS | <p>Check 'Enable HTTPS' box to enable HTTPS channel to encrypt transferred data. You can also define HTTPS port number in 'HTTPS Port' field if you don't want to use default value '443'.</p> |

When you finish, click 'Apply' to save changes.

3-3-3 Wireless

Network

General Advanced **Wireless**

Wireless

Wireless Connection Enable Disable

Network type

Available Networks

| Link | SSID | MAC | Signal | Channel | Encryption | Wireless Mode |
|-----------------------|----------|-------------------|--------|---------|-------------|----------------|
| <input type="radio"/> | NB1 | d6:6d:cd:90:20:2b | | 1 | NONE | Ad-Hoc |
| <input type="radio"/> | ASUS-N16 | bc:ae:c5:c4:1b:1e | | 5 | WPA2PSK/AES | Infrastructure |

The descriptions of every setting in this menu will be given below:

| Item | Description |
|---------------------|--|
| Wireless Connection | Select „Enable“ to activate wireless network function of this IP camera, select „Disable“ to disable it. |
| Network Type | <p>Select the network type of wireless connection.</p> <p>Available options are „Infrastructure“ (Connect the IP camera to a wireless access point), and „Adhoc“ (This IP camera will become a stand-alone wireless network point, other wireless computers / devices can discover this IP camera and connect to it without wireless access point). You can set to „Adhoc“ when you don“t have any wireless access point, but your computer has wireless network card. Set to „Infrastructure“ when you have wireless access point, and you have computers with wired network connection.</p> |
| Available Networks | <p>Here shows all wireless access points found by this IP camera. Please note not all access points will be displayed at the same time, if the access point you expected to connect does not appear, you may have to click „Refresh“ button for several times until it appears. The descriptions of all fields is listed below: Connect: You can select the wireless access point you wish to connect here. SSID: the SSID of all found wireless access points will be shown here. Some wireless access point may hide their SSID; in this case, you have to identify them by their MAC address. MAC Address: If you there are many wireless access points in proximity or some wireless access point hides it“s SSID, you can use MAC address to distinguish them. Signal: Shows the radio signal strength in percent. Channel: Shows the radio channel of this wireless access point. Encryption: Shows the encryption type used by this wireless access point. You must use the same encryption type if you wish to connect to a certain wireless access point. If the wireless access point does not use encryption, „Disabled“ will be displayed here. Network Type: Shows the network type of a certain wireless access point (Infrastructure or Adhoc).</p> |

| | |
|--------------------|--|
| SSID | <input type="text" value="alictest2"/> |
| Channel | 4 - 2.427GHz ▾ |
| Authentication | None ▾ |
| Encryption Type | None ▾ |
| WPA Pre-Shared Key | •••••••• |
| WEP Key Length | 64 bits ▾ |
| WEP Key Format | HEX ▾ |
| Default Key | 1 ▾ |
| WEP Key 1 | •••••••• |
| WEP Key 2 | •••••••• |
| WEP Key 3 | ••••••~ |
| WEP Key 4 | ••••••~ |

| | |
|----------------|--|
| SSID | Input the SSID of the wireless access point you wish to connect. It should be less than 32 alphanumerical characters. When you select a wireless access point above, it's SSID will be filled in this field automatically. However, if the SSID is not displayed (the wireless access point you selected choose to hide it's SSID), you have to know it's SSID and input it here, or you will not be able to connect it. |
| Channel | Select the radio channel you wish to use here. When network type is „Infrastructure“, the radio channel is auto-selected according to the channel that wireless access point uses. You can only select the channel number when network type is „Adhoc“. |
| Authentication | It includes None, Open System, Shared Key 64bits and 128bits, WPA-PSK, WPAS-PSK. Select one of them then the relative items below will transfer gray scale to black scale. Configure the setting consistent with the setting on the wireless router/AP that this IP camera will join the wireless network. Apply the settings then check the wireless networking. |

Wi-Fi Protected Setup(WPS)

Pin Code 00660518

Configure via Push Button

Configure via PinCode Registrar SSID

| | |
|----------|--|
| Pin Code | Here displays the WPS pin code used to connect to WPS-enabled wireless access points. You have to input this number into the WPS enabled access point to establish WPS |
|----------|--|

| | |
|---------------------------|---|
| | connection. |
| Configure via Push Button | Click this button and this camera will enter PBC-style WPS connection state for 120 seconds. Please push „Start PBC“ button on the wireless access point you wish to connect within 120 seconds to establish WPS connection (The remaining time will be displayed on the button). If connection can not be established after 120 seconds, you“ll be prompted by a message box, and you can press „Start PBC“ button to try again. |
| Configure via PinCode | If you have wireless access point’s WPS PIN code, you can input it here and press „Start PIN“ button to start to establish PIN-style WPS connection. |

Wireless Setting Wi-Fi Connection using WPS

Method 1: USE WPS BUTTON

Step 1: Power on the wireless AP and the wireless network camera. Wait for 1 minute for both devices to be up and running.

Step 2: Press the WPS button of the wireless AP. The WPS LED will be blinking (LED status base on different brand device).

Step 3: Press the WPS button of the wireless network camera and waiting for 30 seconds.

Step 4: When the network LED of the camera is blinking, WPS is successfully done.

Step 5: If you have more than 1 camera, repeat step 2~4.

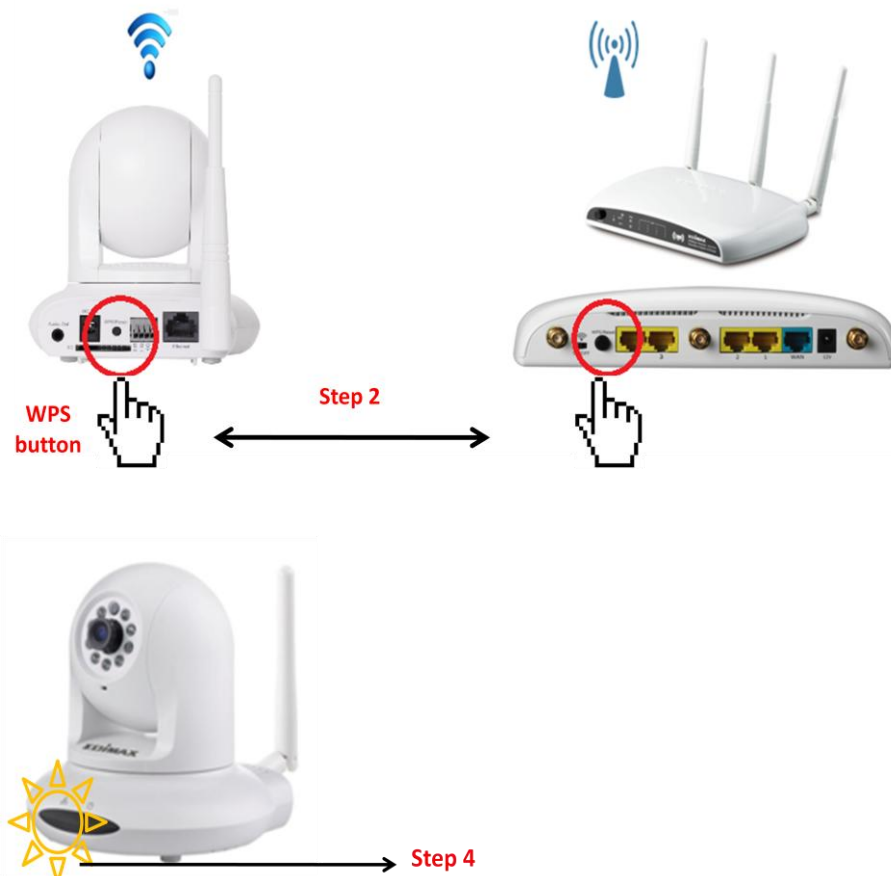

Method 2: USE PINCODE SETTING

Step 1: Power on the wireless AP and the wireless network camera. Wait for 1 minute for both devices to be up and running.

Step 2: Open web browser and logo in wireless server. Go to wireless/WPS setting page.

Step 3: Open web browser and logo in wireless network camera. Go to network/Wireless setting page. And find Wi-Fi Protected Setup (WPS) item.

Step 4: Please find the pin Code on both setting page and key in it in each "Configure via Pin Code". Then push "Start PIN" button on page. .

Step 5: Waiting for 30 seconds. When the network LED of the camera is blinking, WPS is successfully done.

Step 6: If you have more than 1 camera, repeat step 2~5.

IP Camera Page

Apply

Wi-Fi Protected Setup(WPS)

Pin Code: 00082136

Configure via Push Button: Start PBC

Configure via PinCode: Registrar SSID: Start Pin

AP Setting Page

Basic Settings Encryption Advanced Settings **WPS** Access Control Wireless Schedule

WPS

Enable WPS

Wi-Fi Protected Setup Information

| | |
|---------------------|------------|
| WPS Status | Configured |
| Self PinCode: | 68601805 |
| SSID | S-TEST |
| Authentication Mode | WEP |
| Passphrase Key | |

Device Configure

Config Mode: Registrar

Configure via Push Button: Start PBC

Configure via Client PinCode: Start PIN

3-4 IP Filter

When this IP camera is directly connected to Internet and not protected by firewall, this function acts like a mini built-in firewall to protect the safety of this IP camera and avoid attacks from hackers.

Here are the descriptions of every setup item:

| Item | Description |
|-------------------------------|--|
| Enable Filter | Check this box to enable IP address filter, uncheck this Box to disable this function. |
| Accepted IP list | Here lists all IP address that can build connections to this IP camera. If you want to remove a set of IP address from the list, click on the IP address and click 'Remove' button. |
| IP Address (Accepted IP list) | Input the starting and ending IP address of IP address you wish to accept connections here. IP camera will only accept connections established from these IP address. If you want to specify one IP address only, input the same IP address in both field. Click 'New' button to add IP address into accepted IP list. |
| Deny IP list | Here lists all IP address that cannot build connections to this IP |

| | |
|----------------------------------|---|
| | camera. If you want to remove a set of IP address from the list, click on the IP address and click 'Remove' button. |
| IP Address (Accepted IP list) | Input the starting and ending IP address of IP address you wish to deny connections here. IP camera will deny connections established from these IP address. If you want to specify one IP address only, input the same IP address in both field. Click 'New' button to add IP address into deny IP list. |

When you finish with above settings, click 'Apply' button to save changes.

3-5 Video

You can adjust the image of the IP camera in this menu.

There are 3 sub-menus in this menu: Image Setting, Video Setting, and Overlay, which can be accessed by tabs on the top:



3-5-1 Image Setting

You can adjust the image parameters in this page.

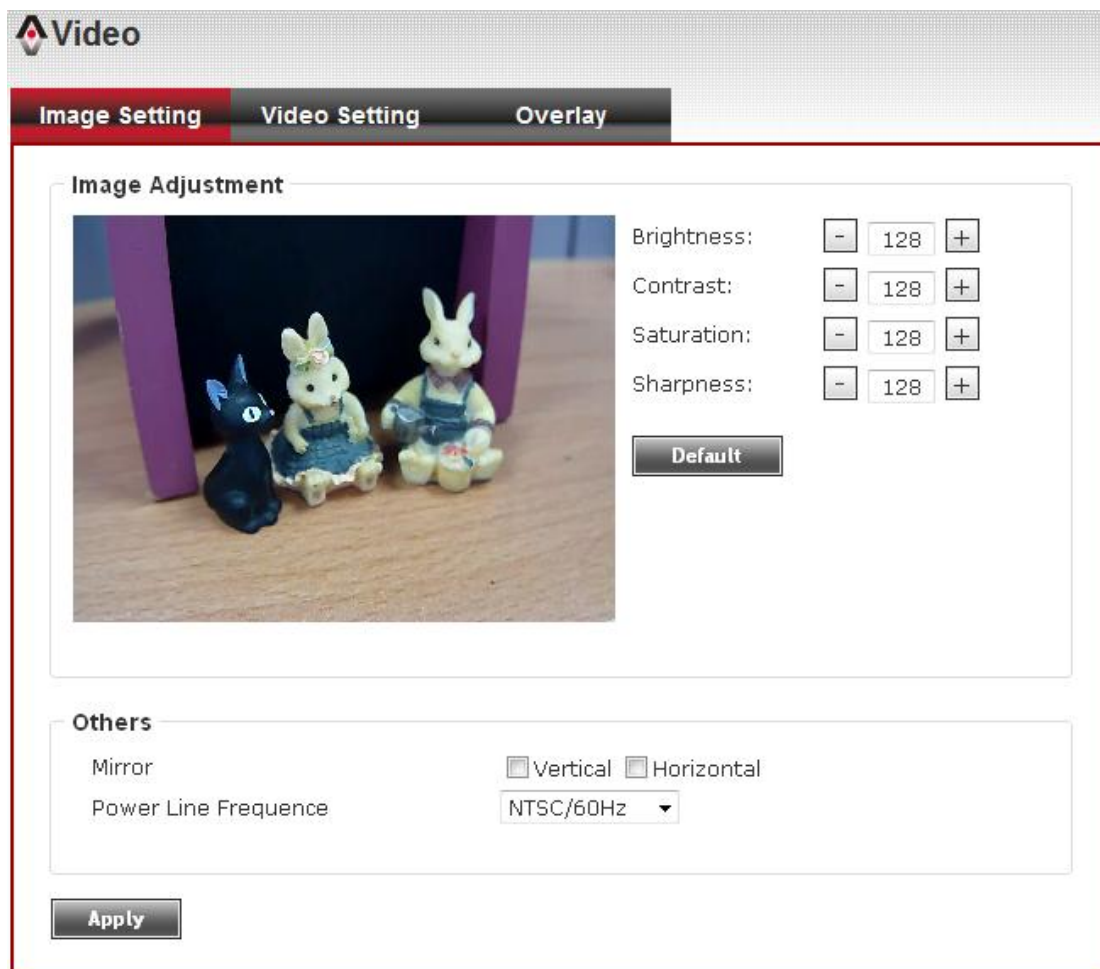

Here are the descriptions of every setup item:

| Item | Description |
|--------------------------------------|--|
| Brightness / Contrast / Saturation / | Control the image parameters. Click ' - ' to decrease value, or click ' + ' to increase value. You can also input the value in the field directly. |

| | |
|----------------------|--|
| Shaprness | |
| Default | Set all above values to default value '128'. |
| Mirror | Check 'Vertical' or 'Horizontal' box to flip the image vertically or horizontally, this will help to correct the orientation of image when IP camera is hanged bottom-up by camera holder. You can click both 'Vertical' and 'Horizontal' box at the same time. |
| Power Line Frequency | Select the frequency of power line of the place you're using this IP camera. This will help to reduce the flicker of certain lights in the image. |

When you finish with above settings, click 'Apply' button to save changes.

3-5-2 Video Setting

You can adjust the video transfer parameters in this page.

Video

Image Setting **Video Setting** Overlay

Main Stream

H.264

Video Resolution: 640x480 (VGA)

Frame Rate: 30 fps

Rate Control: Video quality: Normal

Bitrate: 1500 kbps *number must be between 512~4000.

MPEG4

MJPEG

Video Resolution: 640x480 (VGA)

Frame Rate: 30 fps

Video quality: Normal

Mobile View

Disable

3GPP without Audio

3GPP with Audio

*One snapshot is supported when resolution is under 720P.

Apply

Here are the descriptions of every setup item:

| Item | Description |
|------------------|---|
| H.264 /MPEG4 | Select the compression of main stream: H.264 / MPEG4. |
| Video Resolution | <p>Select video resolution.</p> <ul style="list-style-type: none"> - H.264: 2048x1536 (QXGA) / 1920x1080 (1080p) 1280x960 (960p) / 1280x720 (720p) 720x480 (D1) / 640x480 (VGA) 320x240 (QVGA) - MPEG4: 1920x1080 (1080p) / 1280x960 (960p) 1280x720 (720p) / 720x480 (D1) 640x480 (VGA) / 320x240 (QVGA) MJPEG: 1280x720 (720p) / 720x480 (D1) 640x480 (VGA) / 320x240 (QVGA) <p>Please note that some video resolution is not available when video encoder is 'MPEG4'.</p> <p>When network speed is insufficient, select a lower video resolution will help.</p> |
| Frame Rate | <p>Select video frame rate. Please note that some frame rate is not available when video encoder is 'H.264'.</p> <p>When network speed is insufficient, select a lower frame rate will help.</p> |
| Rate Control | <p>Select video bit rate. You can control bit rate by both 'Video quality' and 'Bitrate':</p> <ul style="list-style-type: none"> - Video quality: There are 5 levels of video quality, select 'very high' to improve video quality but consumes more network bandwidth, and select 'very low' will decrease video quality and consumes less network bandwidth. - Bitrate: Input video's bit rate directly. It must an integer between 512 and 4000. Higher bit rate provides better video quality, but consumes more network bandwidth. |

When you finish with above settings, click 'Apply' button to save changes.

Note:

MJPEG options are only available for portable devices like cell phone.

3-5-3 Overlay Setting

You can adjust the video overlay parameters in this page.

Here are the descriptions of every setup item:

| Item | Description |
|--|--|
| Enable Time Stamp | Check this box to enable overlaying time stamp on video. |
| Remove the background color of the text (for Time Stamp) | Check this box to remove time stamp's background color. You may find this will help the readability of time stamp text in some cases. |
| Enable Text Display | Check this box to display certain text on video, this will help when you need to identify certain IP camera when you have a lot of IP cameras. Please input the text in 'Text' field. You can input up to 15 characters. |
| Remove the background color of the text (Text) | Check this box to remove custom text's background color. You may find this will help the readability of text in some cases. |
| Enable Image Overlay | Check this box to overlay a specific image on video, so you can show certain text / picture on the video and help people to identify this IP camera. Click 'Browse' button to pick a picture on your computer, then click |

'Update' button to use the picture. Please note that there are certain restrictions:

- Select .bmp / .jpg / .jpeg image files only.
- Image's resolution should be less than 160 x 128, and can be divided by 4.
- Do not upload image files that size is greater than 64KB.

When you finish with above settings, click 'Apply' button to save changes.

3-6 Audio

You can adjust audio input / output parameters here.

Here are the descriptions of every setup item:

| Item | Description |
|-------------------------|---|
| Enable Microphone | Check this box to enable microphone. If you don't want to hear voice from IP camera, you can uncheck this box to disable it. |
| Audio Type (Microphone) | The format is fixed as G.711 |
| Microphone Gain | If the voice received by microphone is too loud or silent, you can use this function to improve voice volume, so you can hear voice from IP camera more clearly. <ul style="list-style-type: none"> - Select -2 or -1 dB to correct the voice that is too loud; - Select 0 dB and IP camera will do nothing on the voice; - Select +2 dB to +26 dB to amplify the voice. |

| | |
|--------------------------|--|
| Enable Speaker (Speaker) | Check this box to enable speaker. If you don't want people at IP camera to hear you, you can uncheck this box to disable it. |
| Audio Type (Speaker) | The format is fixed as G.711 |

When you finish with above settings, click 'Apply' button to save changes.

3-7 Motion

This IP camera is capable to detect object's motion, so IP camera will only record when there's motion and save disk storage space.

Motion detection is performed by examine the movement of objects in rectangular motion detection area. You can define up to 3 motion detection areas.

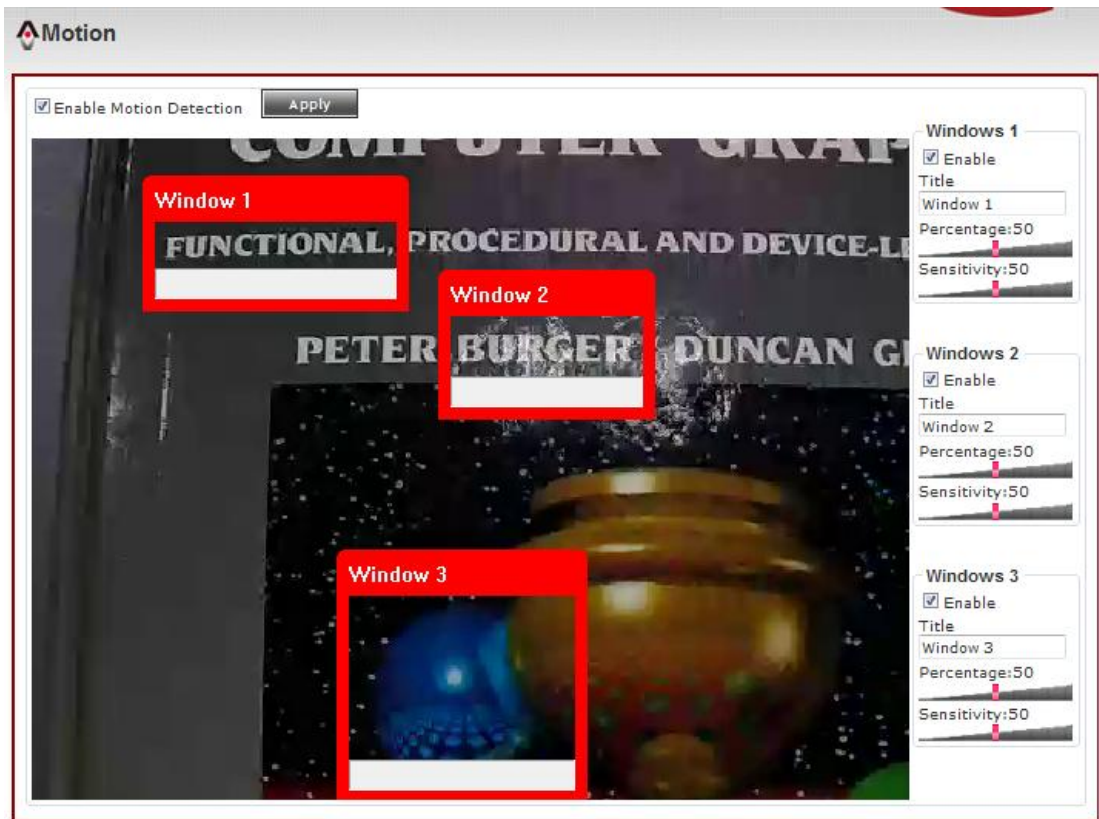

Here are the descriptions of every setup item:

| Item | Description |
|-------------------------|--|
| Enable Motion Detection | Check this box to enable motion detection. |

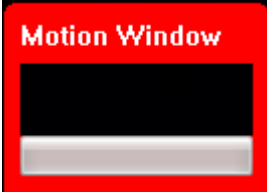
| | |
|--|---|
| <p>Enable (Window 1 to Window 3)</p> | <p>Check this box to enable this motion detection window. You can select window 1 to 3 to enable up to 3 motion detection windows. When a motion detection window is enabled, a rectangular will appear on camera's view, with its title on the top.</p> <ul style="list-style-type: none"> - To move / resize a motion detection window:  <ul style="list-style-type: none"> - Move: Use the mouse to drag the title text. - Resize: Use the mouse the drag the four corners (upper-left/right, lower-left/right) to resize it. If you only want to adjust width or height, drag the four sidebars (top, bottom, left, and right). |
| <p>Title (Window 1 to Window 3)</p> | <p>Input characters in title field to change motion detection area's title text so you can identify it. Please note that you have to click 'Apply' button and the text will change.</p> |
| <p>Percentage</p> | <p>Select the percentage of pixel change that will trigger motion detection alert. Select a lower percentage and you can detect tiny changes in motion detection area.</p> |
| <p>Sensitivity</p> | <p>Select the sensitivity level that will trigger motion detection alert. Select a higher sensitivity and you can detect tiny changes in motion detection area.</p> |

When you finish with above settings, click 'Apply' button to save changes.

3-8 PTZ Control (RS-485)

If you mount the IP camera on pan-tilt camera cradles that support pan-tilt control via RS-485 connection, you can use this function to control pan-tilt camera cradle so you can control the orientation of IP camera from remote place.

Here are the descriptions of every setup item:

| Item | Description |
|---------------------|---|
| Enable RS-485 | Check this box to enable RS-485 functionality. |
| Use Pelco-D | <p>Select this option and RS-485 interface will output pan-tilt control signal in Pelco-D format. This format is widely accepted by most of pan-tilt camera cradles.</p> <p>Type</p> <p><input checked="" type="radio"/> Use Pelco-D Address <input type="text" value="1"/> *number must be between 0~255.</p> <p><input type="radio"/> Use Custom Protocol</p> <p>You have also input pan-tilt camera cradle's address code in 'Address' field (number must be between 0~255). This code must be identical to pan-tilt camera cradle's address code.</p> |
| Use Custom Protocol | <p>When the pan-tilt camera cradle does not support Pelco-D protocol, you can define a protocol's detail by this function.</p> <p>Please refer to pan-tilt camera cradle's user manual to define the protocol.</p> <ul style="list-style-type: none"> - Baud Rate: Select data baud rate of RS-485 interface that pan-tilt camera cradle will accept. When the length of RS-485 connection is very long (longer than 200M), it's not recommended to use high speed connection (greater than 2400bps). - Data Bits: Select data bits of RS-485 connection. - Parity: Select parity bit: odd, even, or space. |

| | |
|--|--|
| | <ul style="list-style-type: none"> - Stop Bit: Select stop bit: 1 or 2. - Home/Up/Down/Left/Right: Input the command string used to move pan-tilt camera cradle to home or up/down/left/right position. You can click 'Test' button to send command string for testing. - Command 1 ~ 5: You can define extra pan-tilt camera cradle control strings here by giving it a name (Command Name) and command string (Hexadecimal Message). You can also click 'Test' button to send command string for testing. |
|--|--|

When you finish with above settings, click 'Apply' button to save changes.

3-9 Event

When there's an event, you can use this setup page to define what IP camera should do, like send an Email or trigger digital output to activate external alarm.



There are three setup pages:



1. Setting: Define a new event and manage events.
2. Media: Define what kind of media file should be saved on designate media.
3. Event Server: Define the details of remote server.

Please refer to following chapters for detailed instructions.

3-9-1 Settings

This page lists all existing events. You can click 'Modify' button to edit an existing event, or 'Remove' to delete an existing event.

To create a new even, just click "New" button to add an Event setting.

Event

Setting **Media** **Event Server**

Event setting

| | | | | | | | | | | |
|--------|--------|-------|--------|-----|-----|-----|-----|-----|-----|-----|
| Modify | Remove | Title | Status | Sun | Mon | Tue | Wed | Thu | Fri | Sat |
|--------|--------|-------|--------|-----|-----|-----|-----|-----|-----|-----|

New

Setting

Enable Setting

Title

Trigger

Motion Detection

Digital Input 1 High ▾

Digital Input 2 High ▾

Schedule Time

Enable Schedule Time

Sun Mon Tue Wed Thu Fri Sat

Time: Always

From 00 ▾ : 00 ▾ To 23 ▾ : 59 ▾

Action

Enable FTP

Enable EMAIL

Enable Samba(Net Storage)

Enable SD CARD

Trigger digital output for 01 ▾ second(s)

Apply

To add a new event, click 'New' button and the descriptions of every setup item is listed below:

| Item | Description |
|--|--|
| Enable Setting | Check this box to enable this event. If you just want to disable this event temporarily, you can uncheck this box to keep this event and disabling while not deleting it. |
| Title | Input any description text for this event so you can identify it quickly. You can use alphabets, numbers, and symbols include: !\$-.@^_~ (no spaces allowed). |
| Motion Detection | Check this box and this event will be activated when one of motion detection window detects motion. |
| Digital Input 1 ~ 2 | Check this box and this event will be activated when digital input 1 or 2's input signal is high or low (select from dropdown list). |
| Enable Schedule Time | Check this box and this event will be activated when designated weekday and time is reached. You also have to check weekday box, and select time from dropdown list. If you select 'Always' as time, this event will be activated during all the day. |
| Enable FTP | Check this box and IP camera will save file on FTP server (refer to 'FTP Server' setting in 'Event Server' tab) when this event is activated. |
| Enable EMAIL | Check this box and IP camera will send an Email to designated recipient address (refer to 'SMTP Server' setting in 'Event Server' tab) when this event is activated. |
| Enable Samba (Net Storage) | Check this box and IP camera will save file on samba server (refer to 'Samba Server' setting in 'Event Server' tab) when this event is activated. |
| Enable SD CARD | Check this box and IP camera will save file on SD card when this event is activated. A working SD card must be inserted into IP camera in advance. |
| Trigger digital output for xx second(s). | Check this box and IP camera will trigger digital out to 'high' state for xx seconds when this event is activated, where 'xx' seconds must be defined by the dropdown list. |

3-9-2 Media

You can define what kind of media file should be saved on designated media.

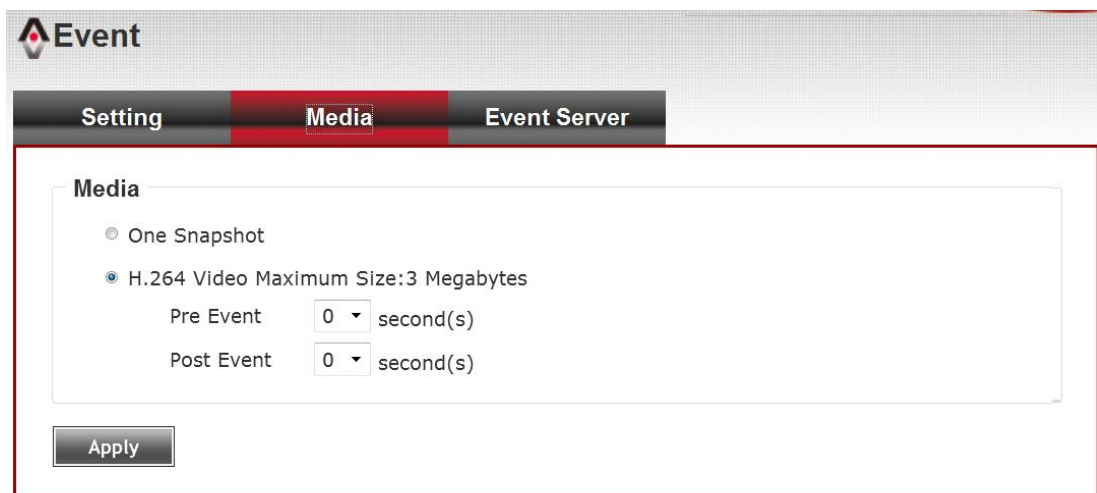

The screenshot shows the 'Event' configuration window with the 'Media' tab selected. The 'Media' section contains two radio button options: 'One Snapshot' and 'H.264 Video Maximum Size: 3 Megabytes'. The 'H.264 Video' option is selected. Below this, there are two dropdown menus: 'Pre Event' and 'Post Event', both set to '0' seconds. An 'Apply' button is located at the bottom left of the configuration area.

Here are the descriptions of every setup item:

| Item | Description |
|--------------|---|
| One Snapshot | Save a picture file when event is triggered. |
| H.264 Video | <p>Save a H.264 video clip. You can also select the recording length before and / or after the time when event is triggered in 'Pre Event' and 'Post' Event'. For example, if you set 'Pre Event' to '2' and 'Post Event' to '3', and an event is triggered at 14:10:30, then the video file will be 5 seconds long, starting from 14:10:28 to 14:10:33.</p> <p>Tips: You may want to know what happened before event is triggered in many cases, especially when object is outside of motion detection window.</p> <p>Note: If the "Pre Event" set to "0" second, the "Post Event" cannot set to "0" second.</p> |

When you finish with above settings, click 'Apply' button to save changes.

3-9-3 Event Server

You can define the details of remote media server: FTP (File), SMTP (Email), and Samba (File).

A Samba server can be any computer running windows operating system with network neighbor function enabled. Many stand-alone network file server also support samba server function.

Here are the descriptions of every setup item:

| Item | Description |
|------------|--|
| FTP Server | <p>Check this box to enable FTP server upload.</p> <p>FTP Server</p> <p><input checked="" type="checkbox"/> Enable FTP Server</p> <p>FTP Server <input type="text"/></p> <p>Port <input type="text" value="21"/></p> <p>User Name <input type="text"/></p> <p>Password <input type="text"/></p> <p>File Path Name <input type="text"/></p> <p><input type="checkbox"/> Enable Passive Mode</p> <p><input type="button" value="Test FTP"/></p> <ul style="list-style-type: none"> - FTP Server: Input FTP server's IP address or hostname. - Port: Input FTP server's port number. In most cases it should be default value '21'. - User Name: Input FTP server's username. - Password: Input FTP server's password. - File Path Name: Input the path where you want to save file |

| | |
|-------------|--|
| | <p>on FTP server, like 'upload/record'. If you want to save file on this FTP user's home directory, you can leave this field blank.</p> <ul style="list-style-type: none"> - Enable Passive Mode: Check this box to force IP camera to communicate with FTP server in passive mode (Some FTP Server may only work when you check this box, while others don't). - Test FTP: Click this button to test FTP server settings above immediately. |
| SMTP Server | <p>Check this box to enable Email send.</p> <p>SMTP Server</p> <p><input checked="" type="checkbox"/> Enable SMTP Server</p> <p>SMTP Server <input type="text"/></p> <p>Port <input type="text" value="25"/></p> <p>Sender Email Address <input type="text"/></p> <p>Receiver #1 Email Address <input type="text"/></p> <p>Receiver #2 Email Address <input type="text"/></p> <p>Subject <input type="text" value="NC-213"/></p> <p><input type="checkbox"/> Authentication</p> <p> User Name <input type="text"/></p> <p> Password <input type="text"/></p> <p><input type="checkbox"/> Requires SSL Encryption</p> <p><input type="checkbox"/> STARTTLS</p> <p><input type="button" value="Test SMTP"/></p> <ul style="list-style-type: none"> - SMTP Server: Input SMTP server's IP address or hostname. - Port: Input SMTP server's port number. In most cases it should be default value '25'. - Sender Email Address: Input the sender's email address that will appear in the Email send by IP camera. This will help you to identify the Email sent by this IP camera, and may help when you have anti-spam software installed (you can set this Email address to 'White List' in your anti-spam software) - Receiver #1 Email Address: Input primary recipient's Email address. This field is required. - Receiver #2 Email Address: Input backup recipient's Email address. This field is optional. - Subject: Input Email title that will appear in the Email send by IP camera. This will help you to identify the Email sent by this IP camera. - Authentication: Check this box when authentication is required by the Email server you're using. You also need to |

| | |
|--------------|--|
| | <p>input Email server's username and password in corresponding field.</p> <ul style="list-style-type: none"> - Requires SSL Encryption: If your Email server required SSL encryption, check this box. Please note that some Email server uses different port number than standard port 25 when SSL encryption is used. - STARTTLS: If your Email server required STARTTLS encryption, check this box. Please note that some Email server uses different port number than standard port 25 when STARTTLS encryption is used. - Test SMTP: Click this button to test SMTP server settings above immediately. |
| Samba Server | <p>Check this box to enable Samba server file upload.</p> <div data-bbox="438 728 1284 1086"> <p>Samba Server</p> <p><input checked="" type="checkbox"/> Enable Samba Server</p> <p>Samba Server Address <input type="text"/></p> <p>Path <input type="text"/></p> <p>User Name <input type="text"/></p> <p>Password <input type="text"/></p> <p><input type="button" value="Test SMB"/></p> </div> <ul style="list-style-type: none"> - Samba Server Address: Input Samba server's IP address or hostname. - Path: Input the path where you want to save file on Samba server, like 'upload/record'. If you want to save file on this user's home directory, you can leave this field blank. - User Name: Input Samba server's username. - Password: Input Samba server's password. <p>* Username and password can NOT leave blank.*</p> <ul style="list-style-type: none"> - Test SMB: Click this button to test Samba server settings above immediately. <p><i>Tips: Some samba server does not have username and password check, you can just input samba server address and path to access the file storage space.</i></p> |

When you finish with above settings, click 'Apply' button to save changes.

3-10 Recording to SD Card

When a SD card is inserted into IP camera, you can save video files on it.

Note:

- 1. Be sure that the SD Card format should be FAT32. The NTFS format cannot be supported by this camera.**
- 2. Unlink motion detection, this function will record video at specified time period on selected weekday(s).**

Recording

Enable External storage Recording
Maximum Size of Each File MB

Enable adding timestamp to files

Recording Schedule

Sun Mon Tue Wed Thu Fri Sat

Time: Always
 From : To :

Here are the descriptions of every setup item:

| Item | Description |
|-----------------------------------|--|
| Enable External storage Recording | Check this box to record video on SD card. |
| Maximum Size of Each File | Input the maximum size of every video file from 1MB to 50MB. IP camera will start a new video file when a recording video file reaches the size limit stated here. |
| Recording Schedule | Define the recording schedule. You can check Sun to Sat boxes to represent a weekday, and specify time period in 'From' and 'To' field. Select 'Always' to record 24 hours in selected weekday(s). |

When you finish with above settings, click 'Apply' button to save changes.

3-11 SDHC

The IP camera module has an optional SD card slot PCBA board. The standard module does not include this board. The UI shows the capacity is 0 MB when the module without SD card slot and memory card.

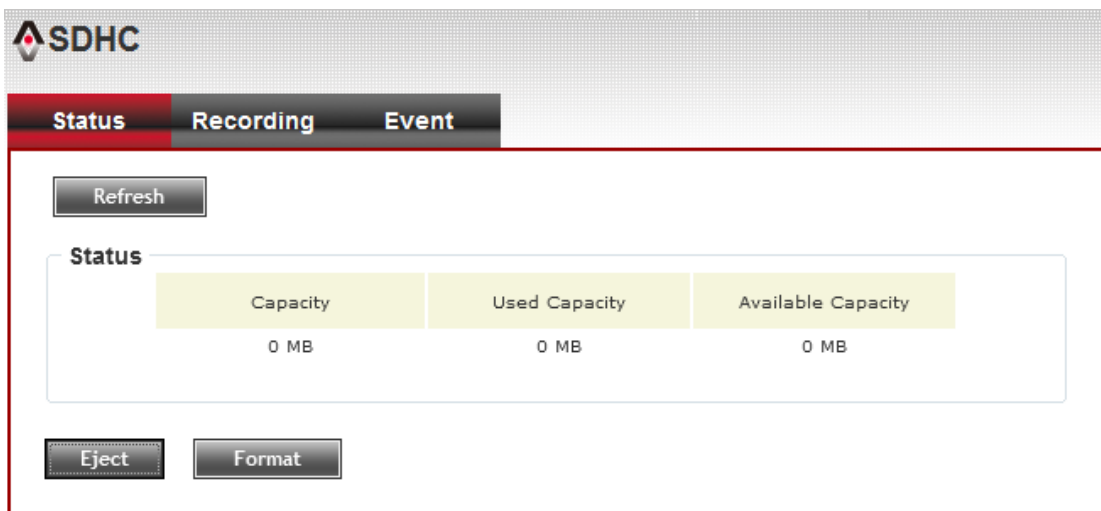

If you need the

function please check the option when you place the order of the IP camera module. Once the module equipped SD card slot and SD card is inserted, the UI will show the capacity of the SD card like the image hereunder.

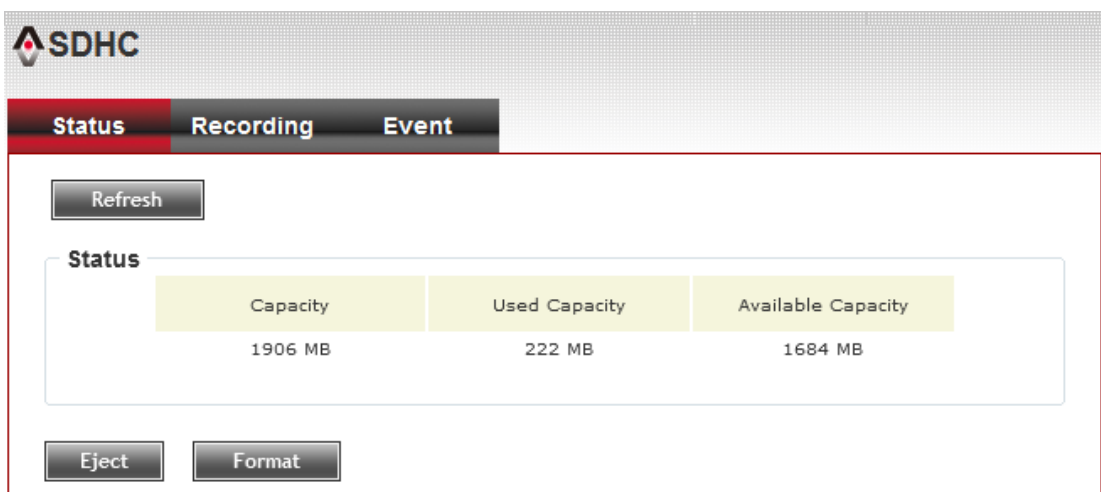

There are two UI pages to show the record on the SD card. They are mapping to the setting of "Recording to SD card" and "Event" accordingly.

Click "All file" to list all files. You also can define the range and click "Search" to sort the files needed. It shows like the images in the next page.

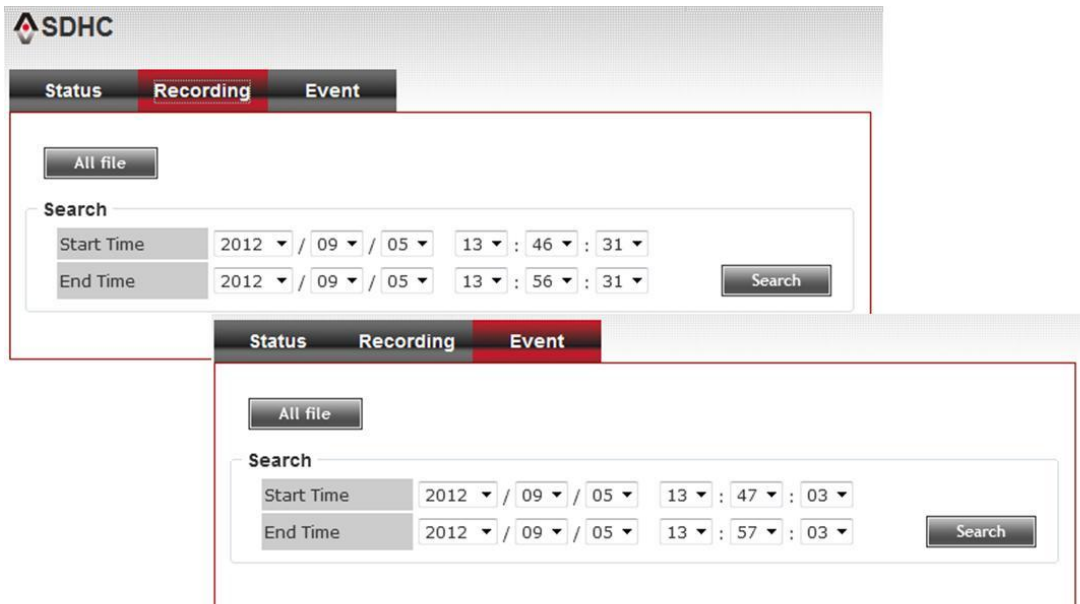

Set the time range then click “Search” then shows the records like below.

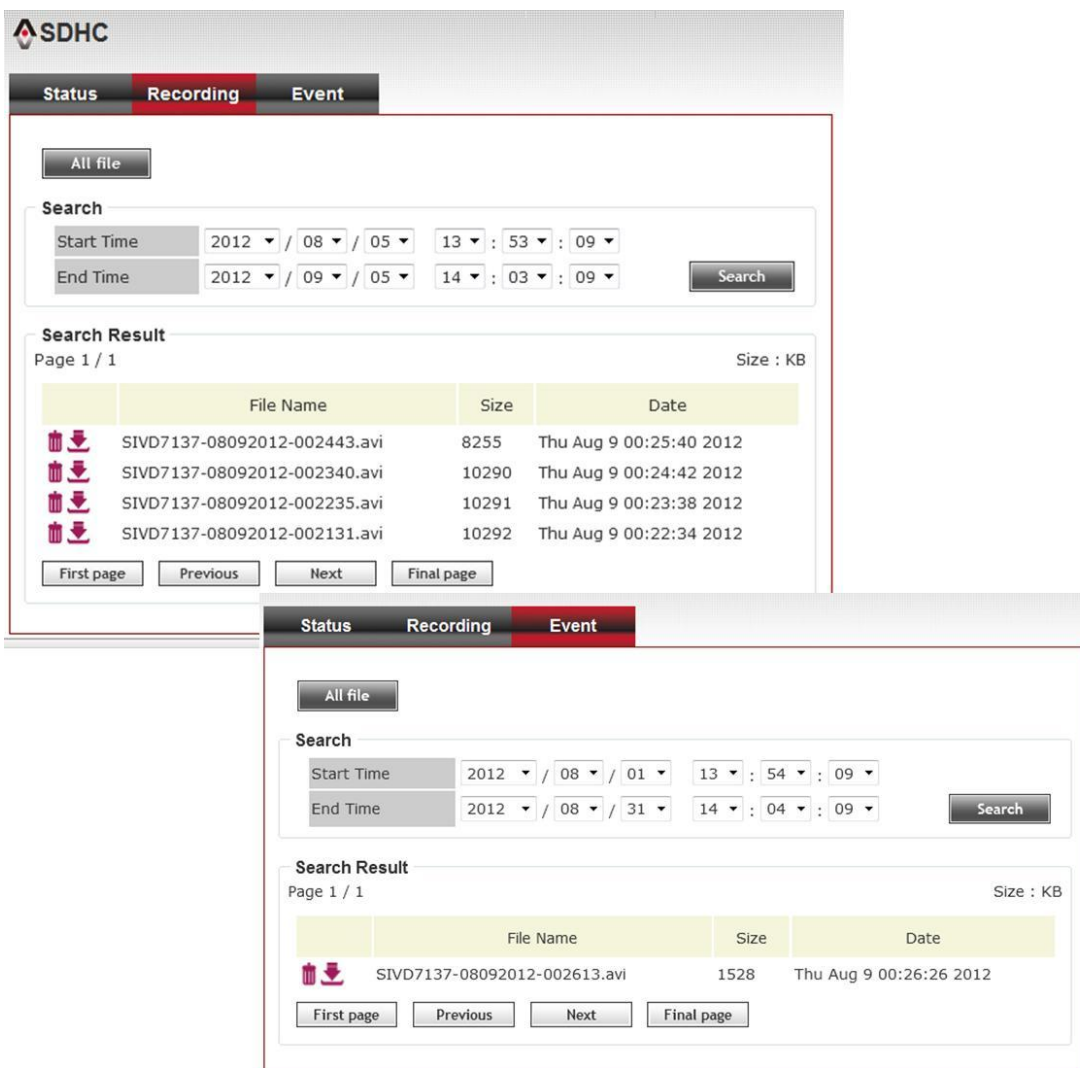

3-12 Log

You can check the usage log of IP camera here.

 Log

System Log

| Item | Date and Time | Event |
|------|---------------------|---|
| 1. | 06/12/2011 19:13:53 | admin login on 1.677728.705901.707517 |
| 2. | 06/12/2011 18:09:04 | [EVENT MGR]: reload config file |
| 3. | 06/12/2011 18:07:43 | [EVENT MGR]: reload config file |
| 4. | 06/12/2011 18:07:43 | admin login on 1.677728.705901.707531 |
| 5. | 06/12/2011 18:02:08 | [EVENT MGR]: reload config file |
| 6. | 06/12/2011 17:37:25 | admin login on 1.564392.592565.564392 |
| 7. | 06/12/2011 11:36:50 | admin login on 1.564392.592565.593691 |
| 8. | 06/12/2011 11:06:50 | admin login on 1.564392.592565.594071 |
| 9. | 06/12/2011 09:37:11 | admin login on 1.602008.630181.602008 |
| 10. | 06/12/2011 09:03:02 | admin login on 1.461328.489501.490750 |
| 11. | 06/12/2011 09:01:54 | [RTSP SERVER]:Start one session<192.168.94.101> |
| 12. | 06/12/2011 09:01:53 | [RTSP SERVER]:Stop one session<192.168.94.101> |
| 13. | 06/12/2011 05:01:47 | [NET]:UPnPAV Disable |
| 14. | 12/31/1969 16:00:50 | [RTSP SERVER]:Start one session<192.168.94.101> |
| 15. | 12/31/1969 16:00:49 | [RTSP SERVER]:Stop one session<192.168.94.101> |
| 16. | 12/31/1969 12:00:43 | [NET]:UPnPAV Disable |
| 17. | 12/31/1969 21:33:23 | admin login on 1.611792.639965.641420 |
| 18. | 12/31/1969 16:00:55 | Sync with NTP server: [1969/12/31 16:00:55] |
| 19. | 12/31/1969 16:00:51 | [RTSP SERVER]:Start one session<192.168.94.101> |
| 20. | 12/31/1969 16:00:49 | [RTSP SERVER]:Stop one session<192.168.94.101> |

In this page, you can click:

1. First page / Final page: Jump to first / final page of log.
2. Previous / Next: Jump to previous or next page of log.
3. Remove: Clear log. You'll be prompted for confirmation.

3-13 Device Info

You can check the information and network settings of this IP camera. These information are very useful when you need to repair or fix the problem of this IP camera.

An example of device info page look like this:

The screenshot displays the device information page for an IP camera, organized into several sections:

- Basic:**
 - Camera Name
 - Firmware version: 1.01.76
 - MAC: d4:a4:25:00:20:2a
 - Camera Date and Time: 05/21/2012 22:35:10
- H.264:**
 - Video Resolution: 1280x960 (950P)
 - Video Quality: Normal
 - Frame Rate: 30 fps
- Audio:**
 - Microphone In: Disable
 - Microphone Gain: +18 dB
 - Speaker Out: Disable
- Mobile View:**
 - 3GPP Enable: Disable
- Network:**
 - IP MODE: DHCP IPv4/IPv6
 - IP Address(IPv4): 192.168.102.201
 - IP Address(IPv6)
 - Subnet Mask: 255.255.255.0
 - Gateway: 192.168.102.253
 - Primary DNS: 61.56.211.185
 - Secondary DNS: 168.95.1.1

3-14 Maintenance

You can do some maintenance job about this IP camera here.

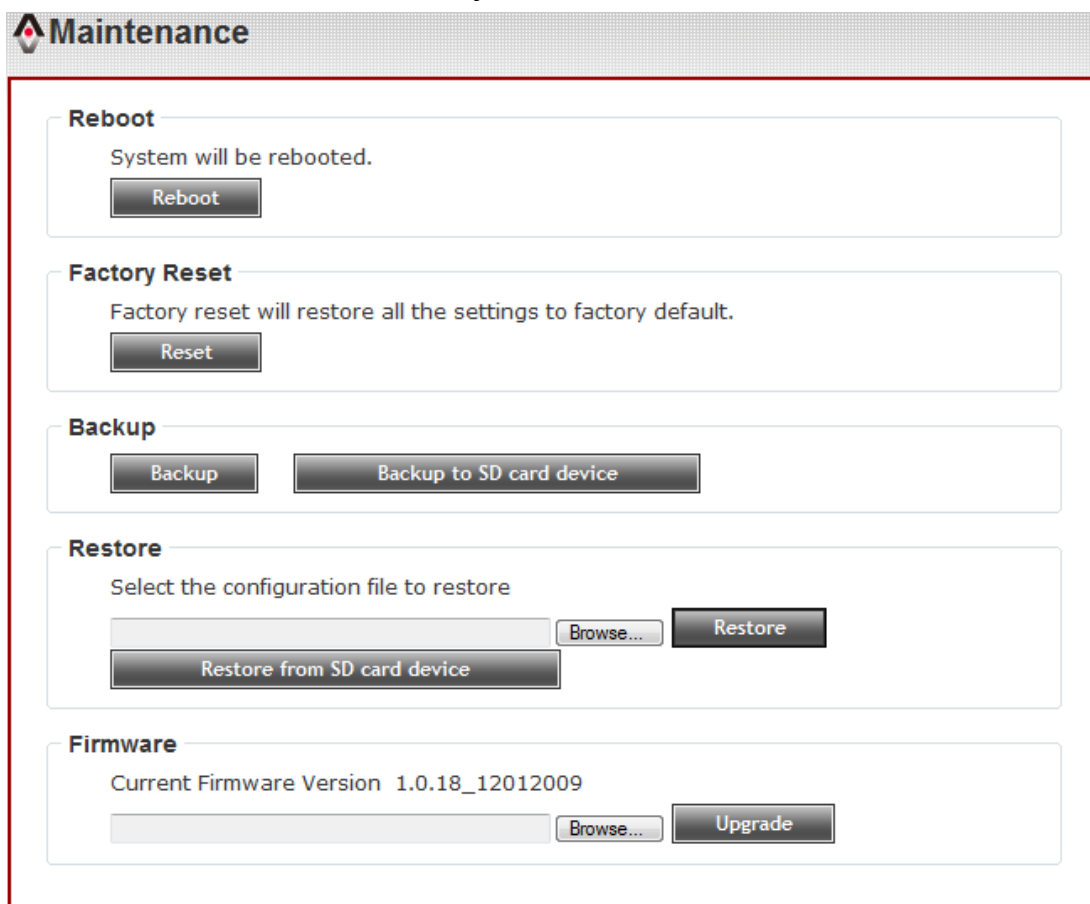

Here are the descriptions of every setup item:

| Item | Description |
|--------------------------------|---|
| Reboot | Click this button to reboot the IP camera. This function is useful when you find IP camera is not working properly. |
| Reset | Clear all settings of IP camera and reset to factory default setting. |
| Backup | Backup IP camera's setting and save it on your computer. |
| Backup to Micro SD card device | Backup IP camera's setting and save it on Micro SD card. A Micro SD card must be inserted into Micro SD card slot when you click this button, or you'll receive an error message. |
| Restore | Restore a previously-saved configuration file saved on your computer. Click 'Browse' button to select a file on your computer first, then click 'Restore' button. |
| Restore from SD card device | Restore IP camera's configuration which is previously-saved on SD card. |

| | |
|---------|--|
| Upgrade | Upgrade IP camera's firmware. Click 'Browse' button to select a firmware image file on your computer first, then click 'Upgrade' button. |
|---------|--|

3-15 Language

You can change the display language of web interface.

Click 'Language' button and select one language. More languages may available in latest firmware file.

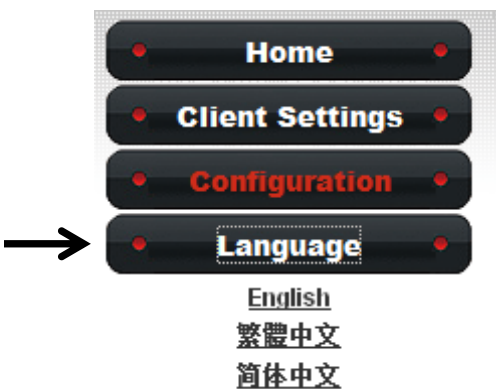

CHAPTER IV: EDIVIEW 64-CHANNEL VIEWER

4-1 EdiView Installation

Please follow the following instructions to setup EdiView on Windows Vista / 7 operating system.

Please note: You must login as system administrator when you're installing EdiView .

1. Locate EdiView setup file, and double-click on it to start EdiView software installation.

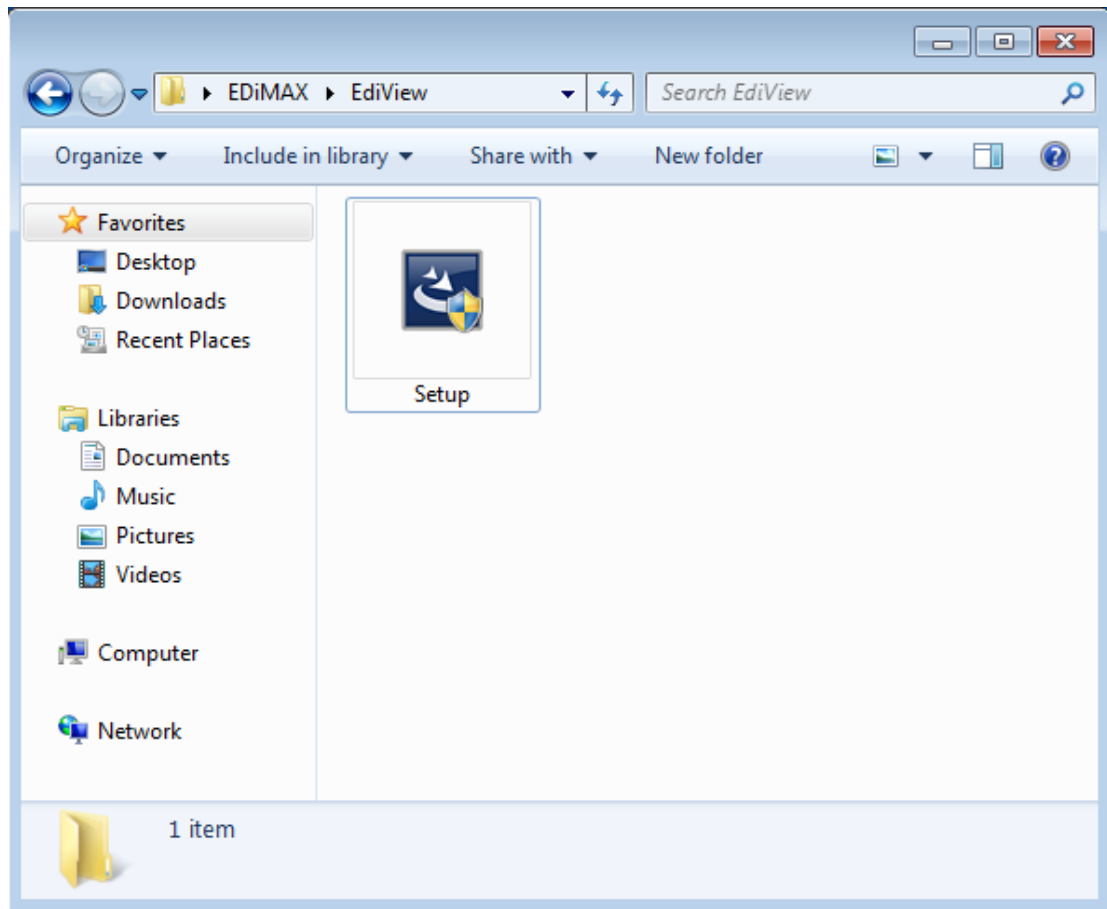

2. You'll see a User Account Control security warning message appear, click 'Yes' to continue.

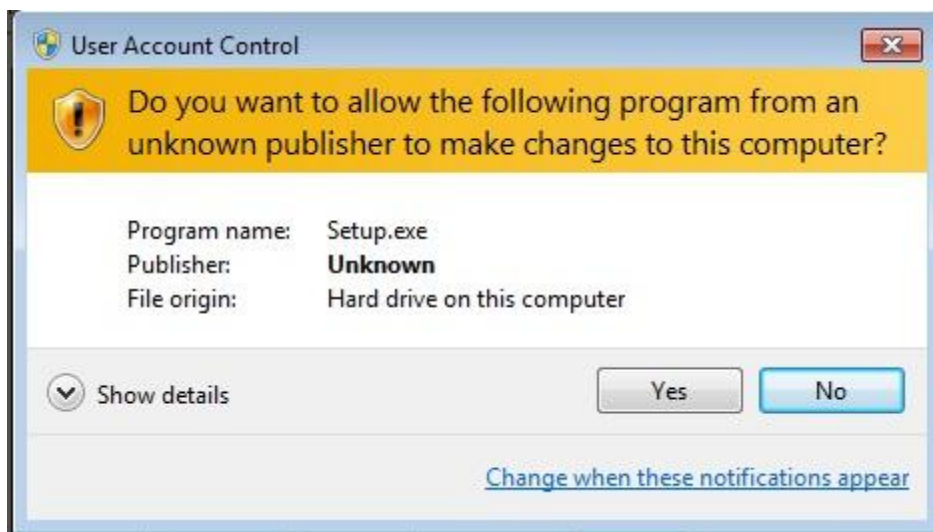

3. Click 'Next' to continue.

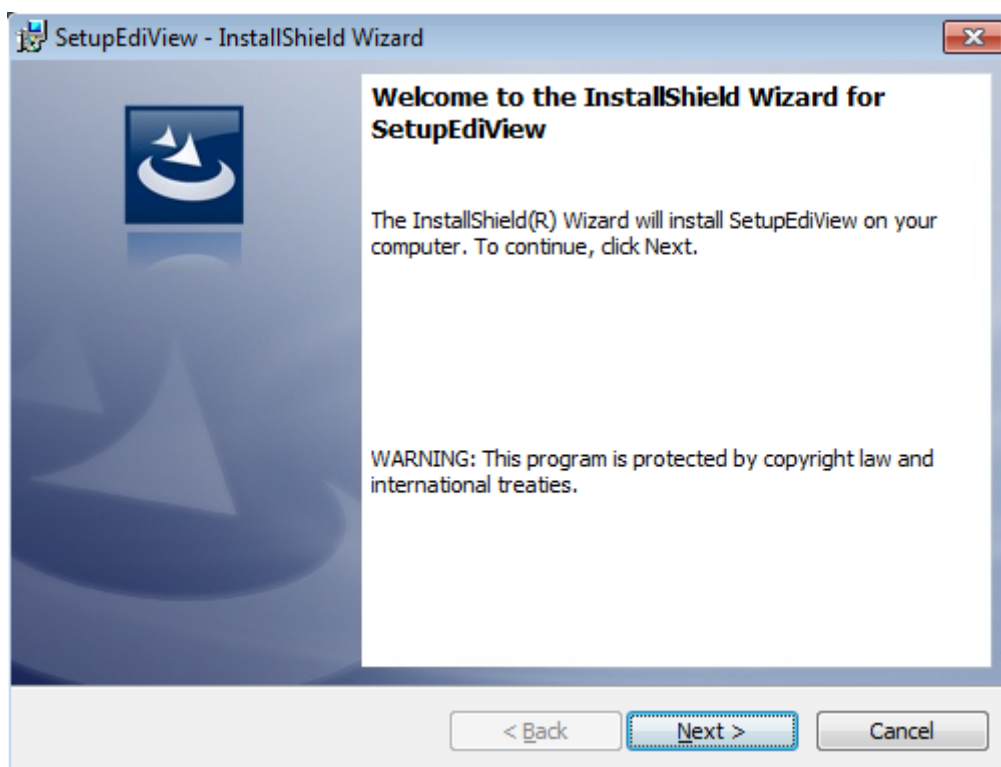

4. Click 'Install' to begin installation.

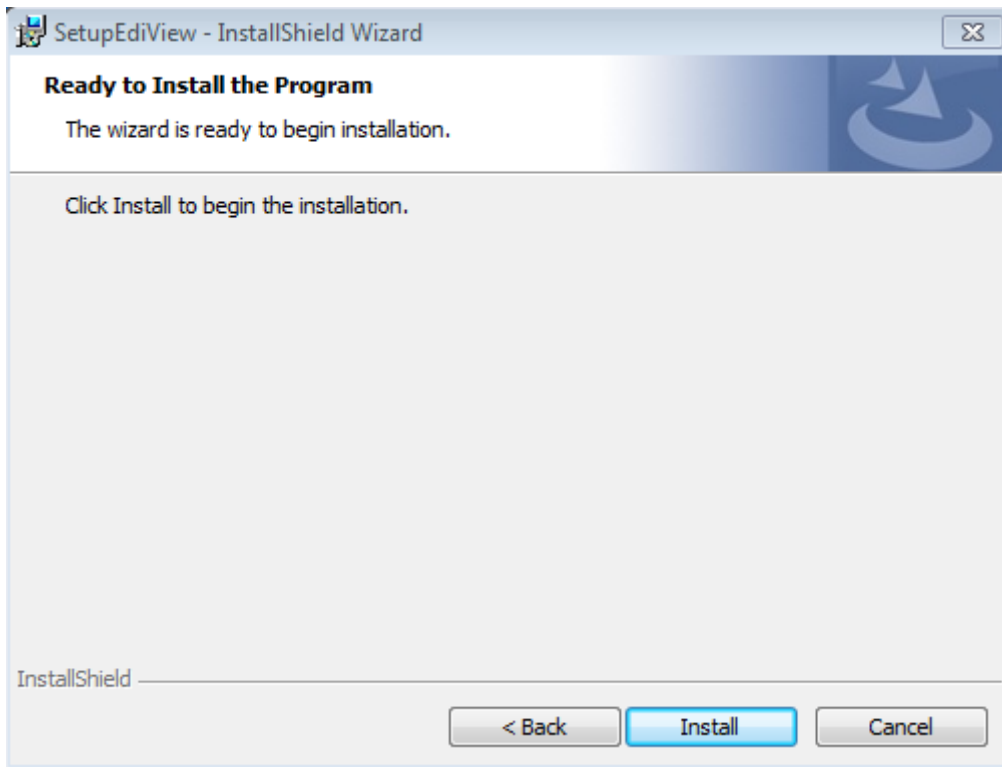

5. Use wait while installation is being performed. This may take few minutes to done, please be patient.

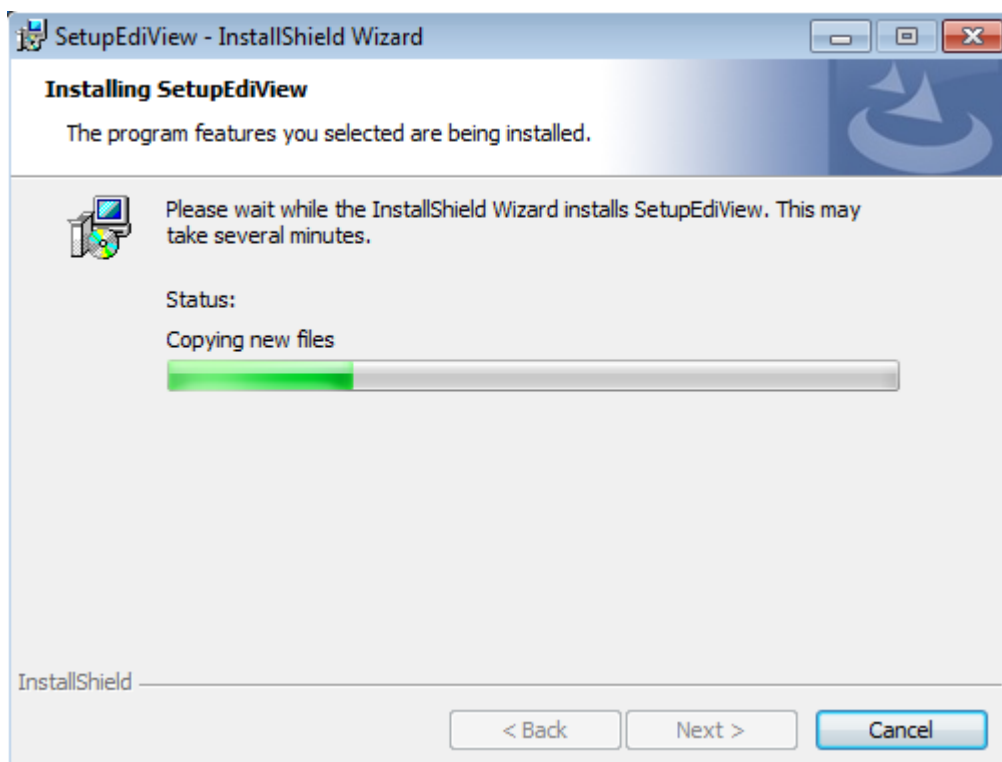

6. The second part of installation will start automatically.

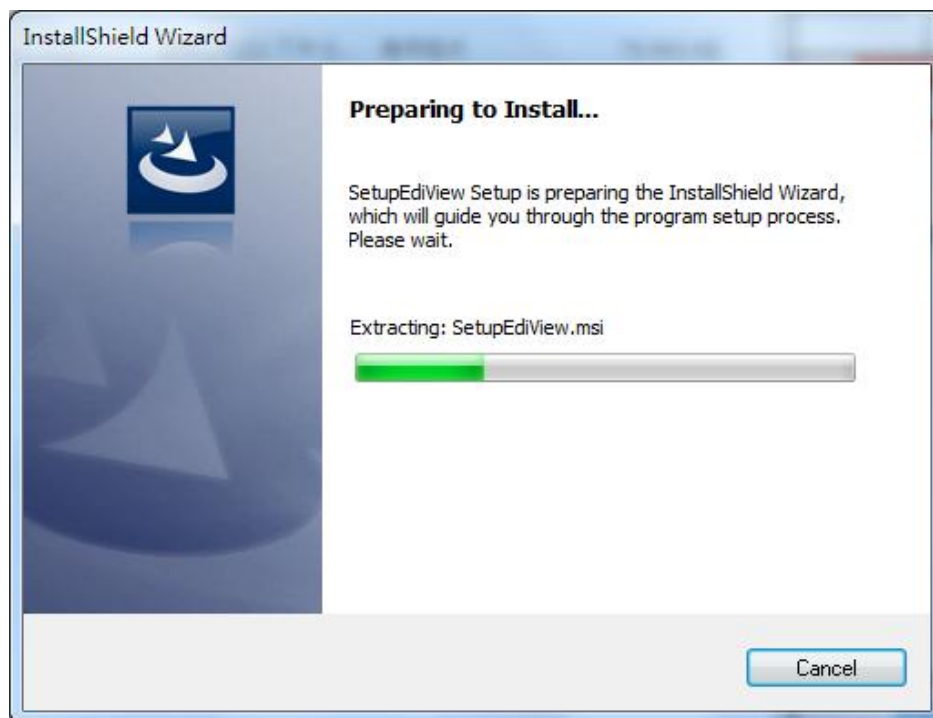

7. A new setup window will appear, please click 'Next' button to continue.

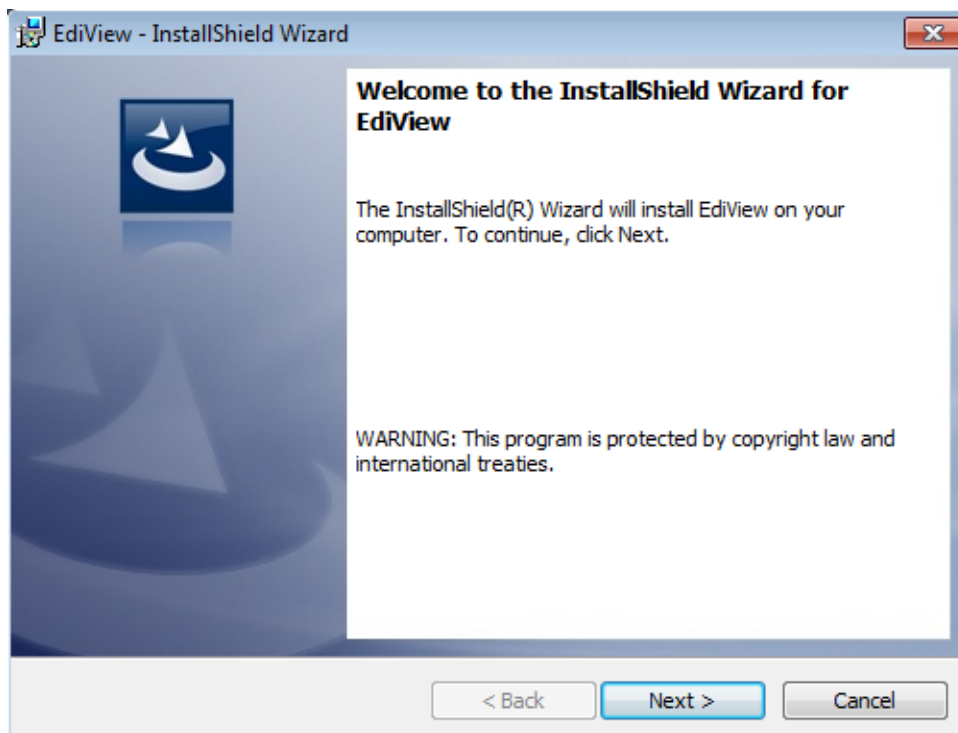

8. You can select a folder on your computer to install EdiView by clicking 'Change' button, or simply click 'Next' button directly to accept default folder.

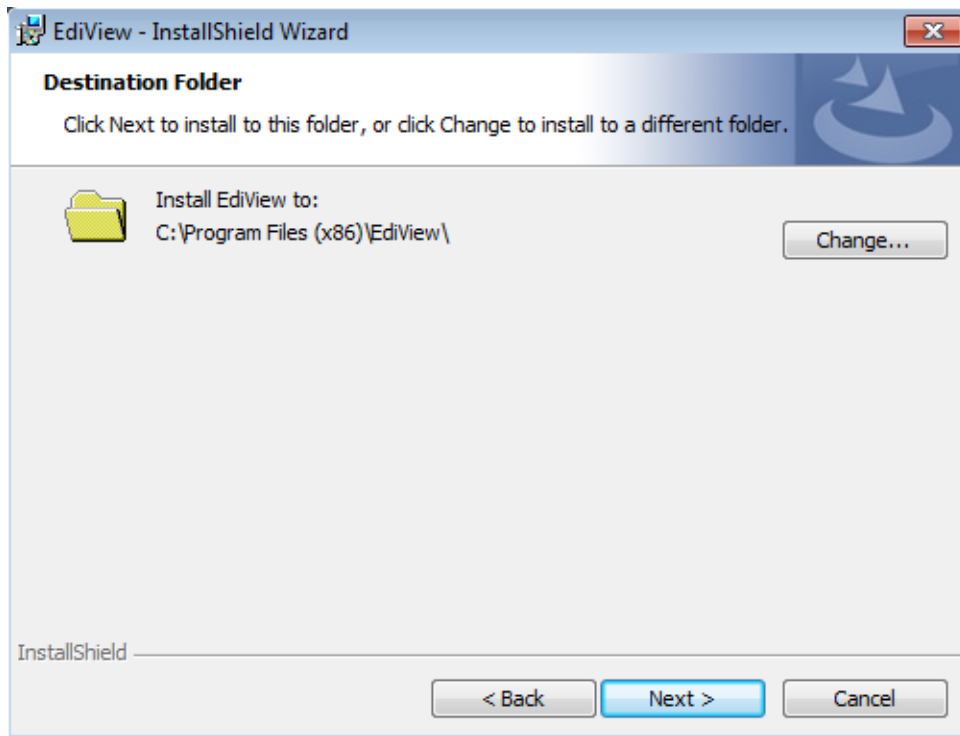

9. Click 'Install' to continue.

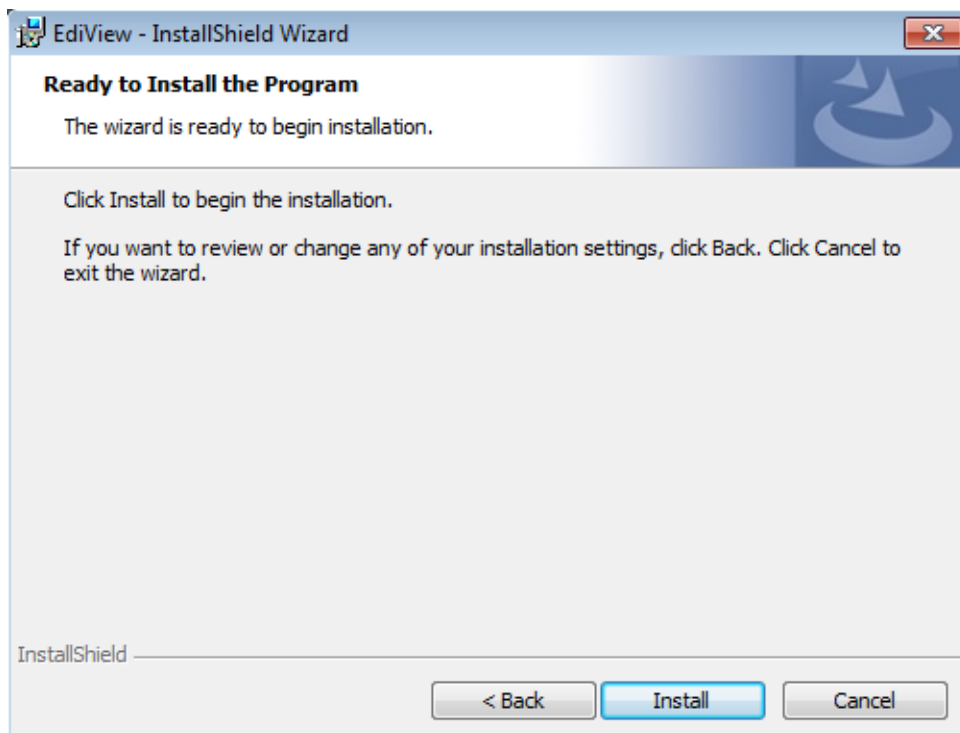

10. Installation will take few minutes, please be patient.

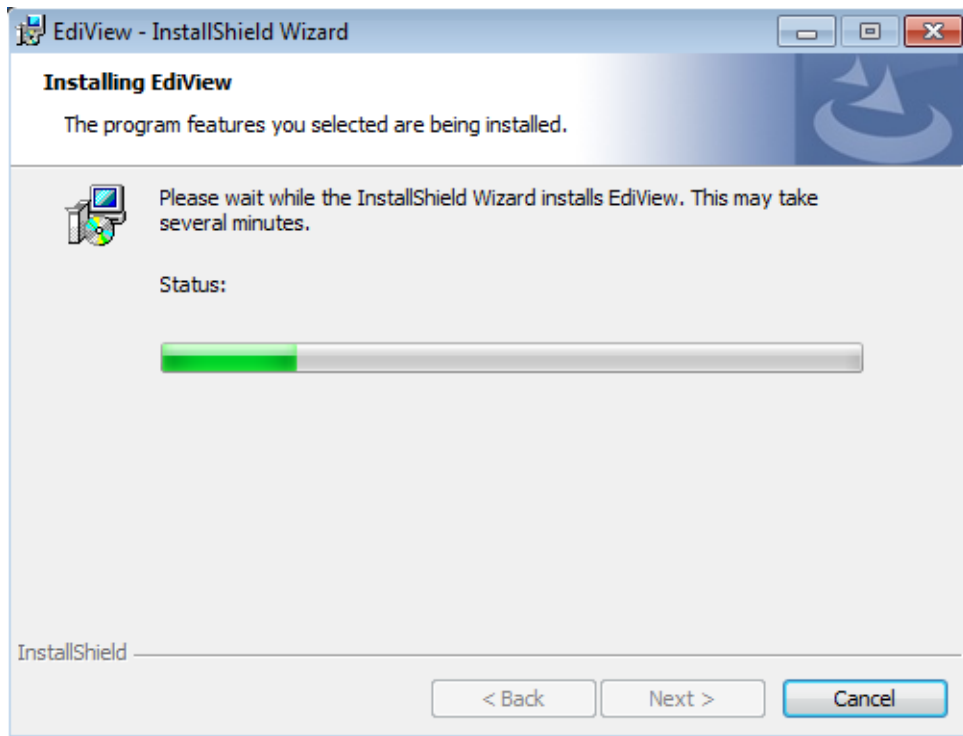

11. Click 'Finish' when you see this message. EdiView is ready to use now.

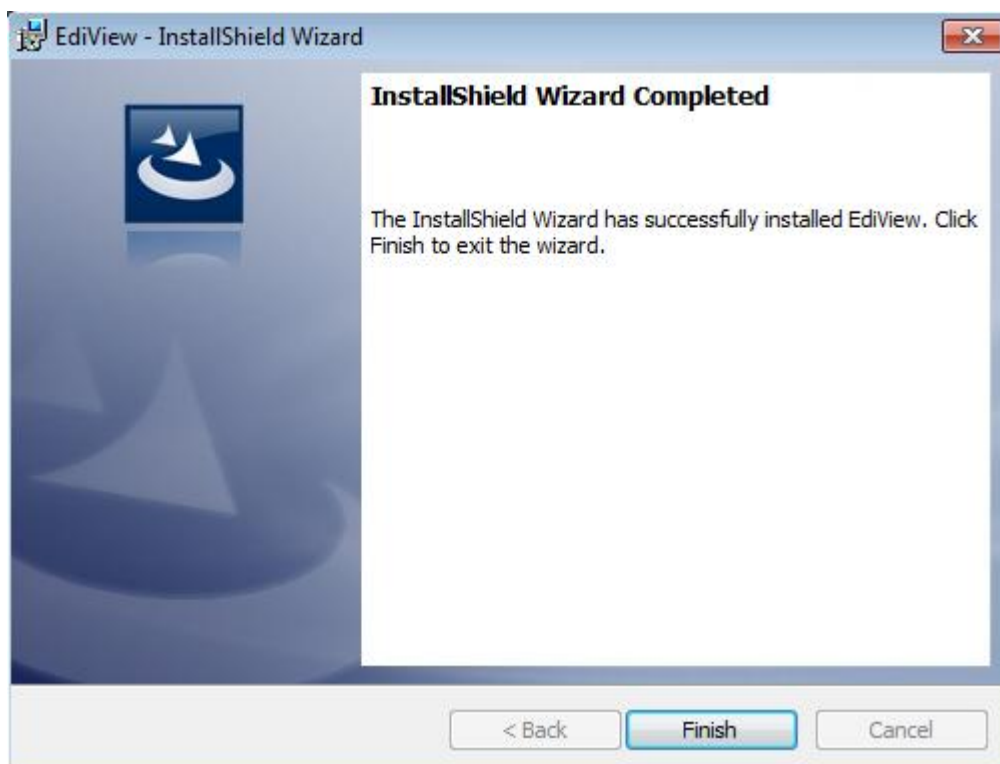

12. MSDE (Microsoft SQL Database Engine) installation procedure will start at the same time. Please wait until it completes.

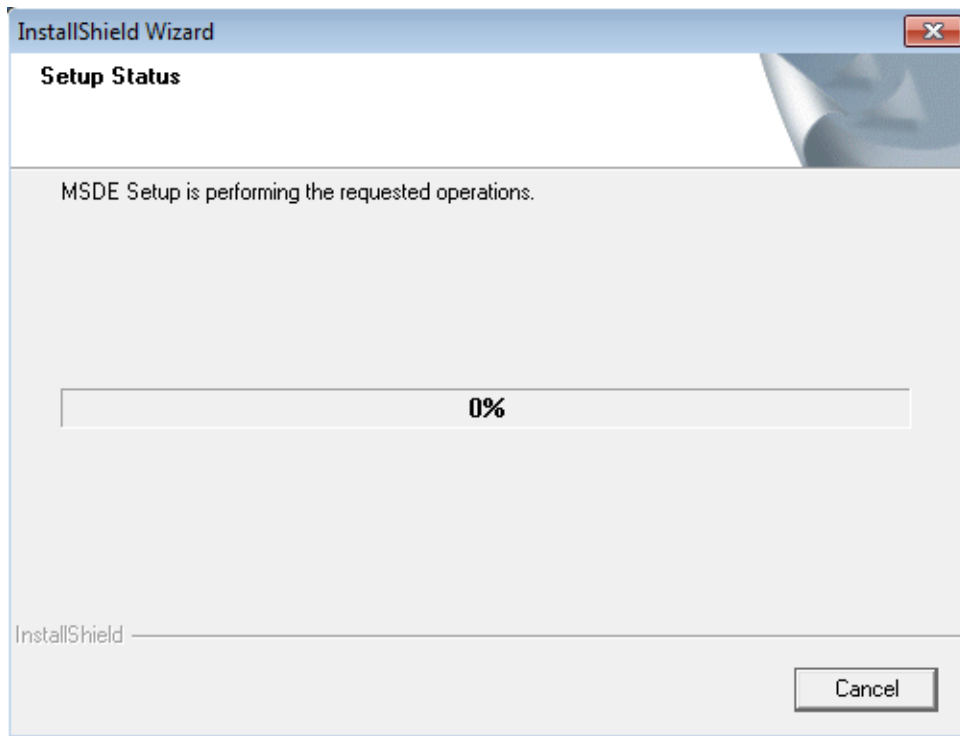

13. You'll be prompted that this program has compatibility issues, click 'Run program' to continue.

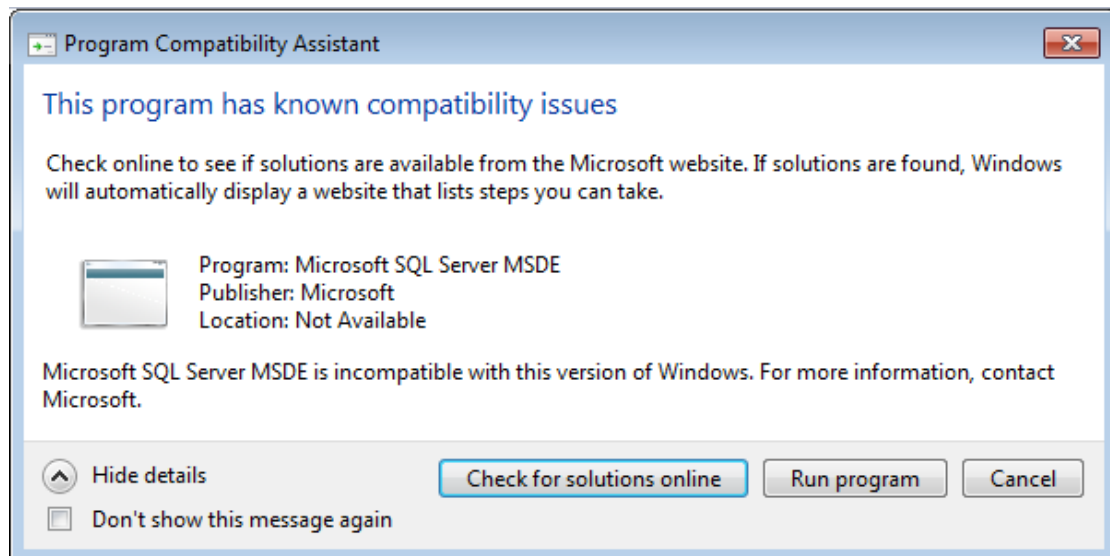

14. MSDE installation requires computer reboot to complete, click 'Finish' to reboot the computer.

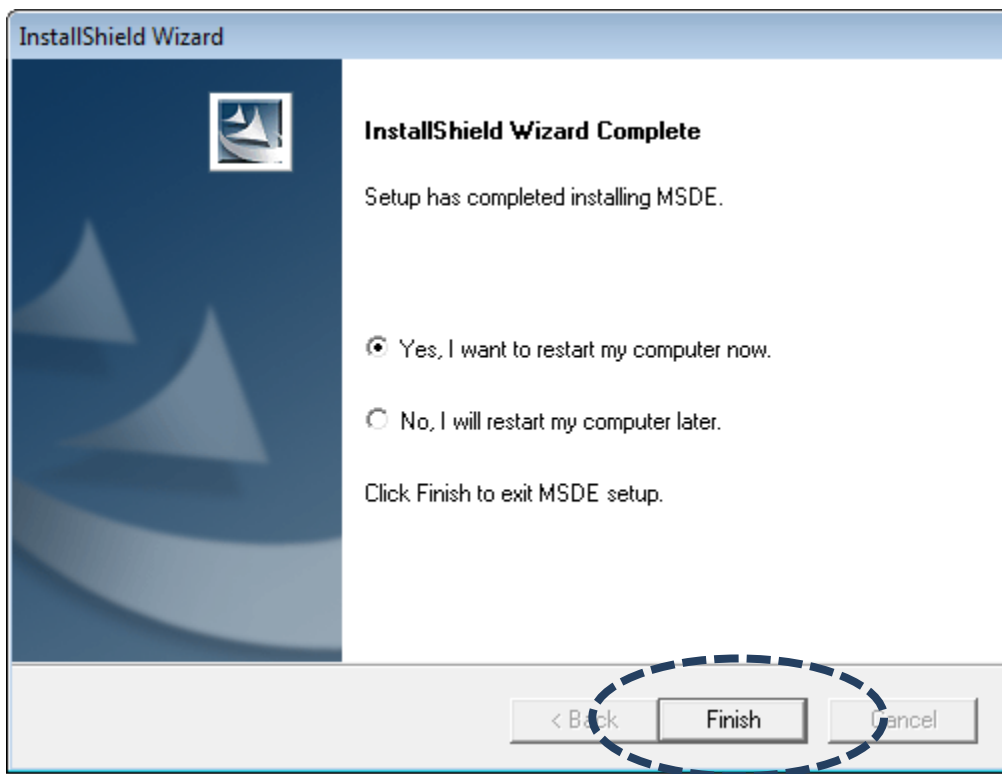

15. A new icon will appear on your computer's desktop, you can double click on it to start EdiView.



4-2 EdiView Interface

To start EdiView, double-click EdiView icon on your computer's desktop:



Or click 'Start' button of Windows, and select 'All Programs' -> 'EdiView'

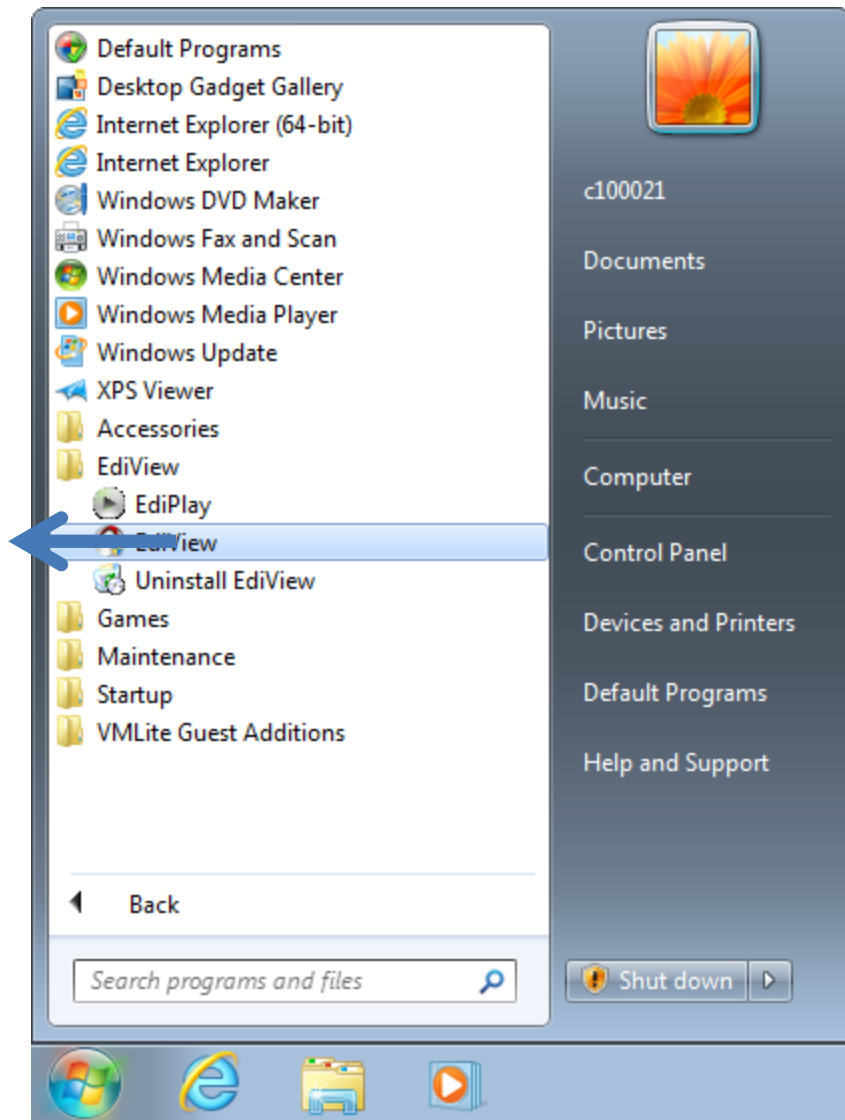

You'll see a User Account Control security warning message appear, click 'Yes' to continue.

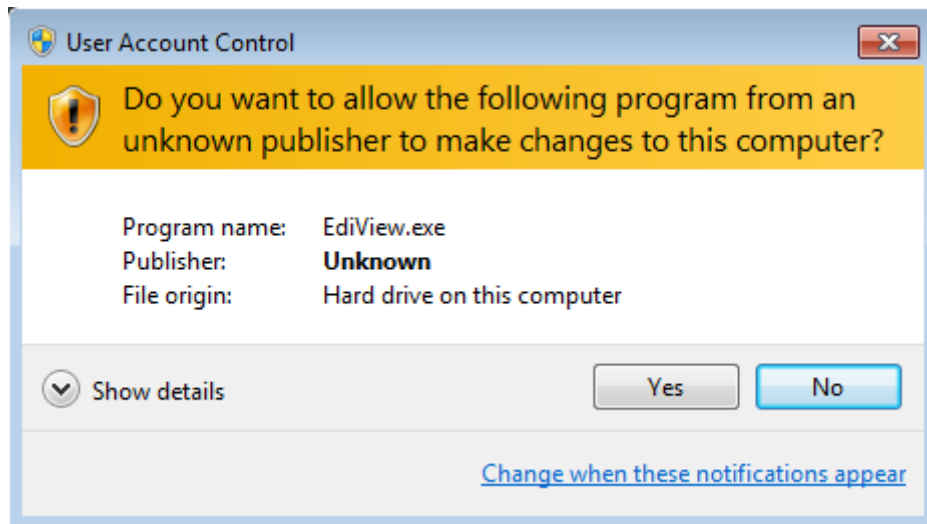

EdiView login window will appear.





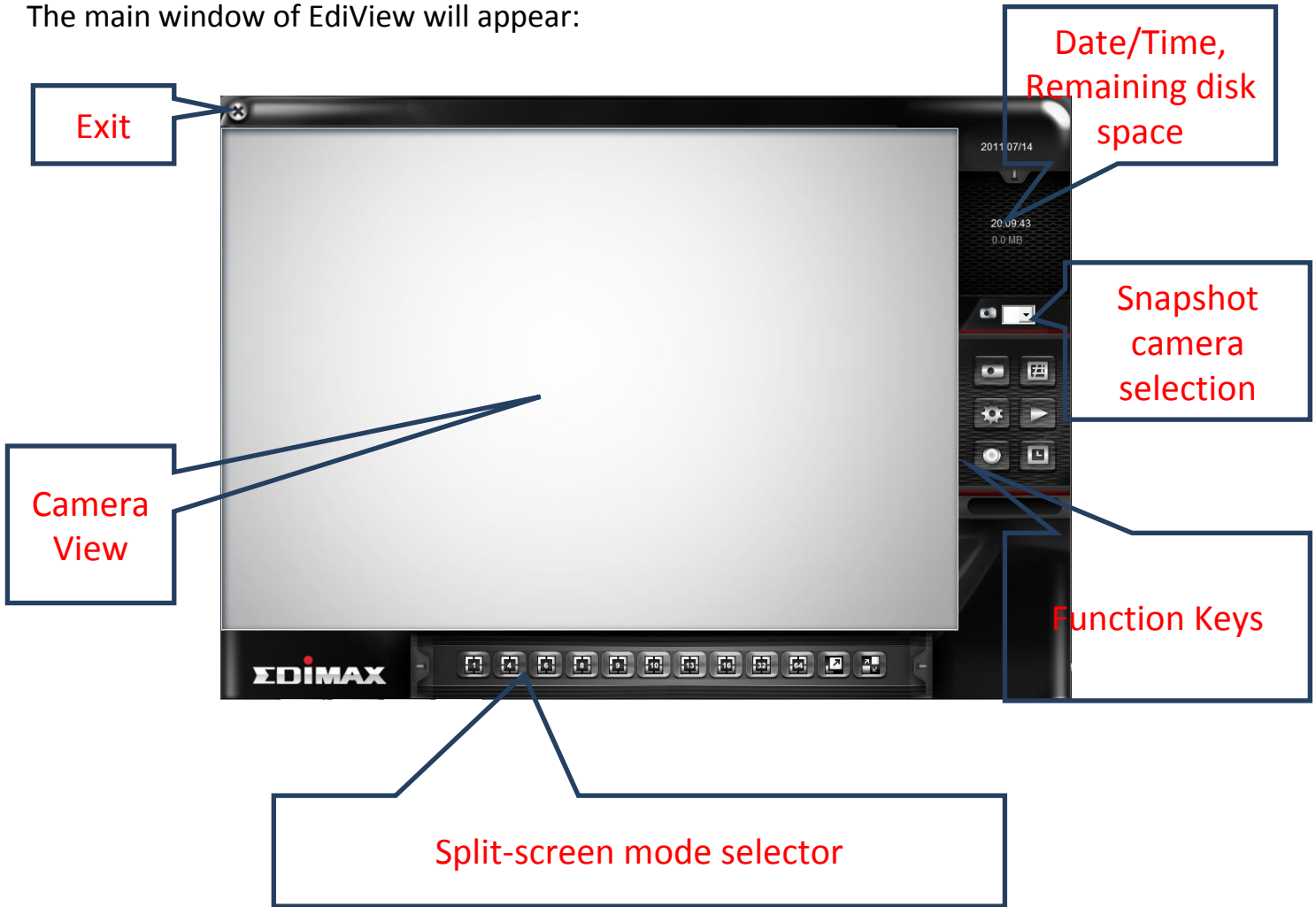

Default user ID is 'admin' and default password is '1234', click 'OK' when ready.

The main window of EdiView will appear:



The descriptions of every item are listed as follow:

| Item | Description |
|---|--|
| <p>Split-screen mode selector</p>  | <p>EdiView supports from 1 to 64 cameras split views. The video from IP camera will display in split-screen display cells, and you can view up to 64 IP cameras at the same time. Click the button to select the number of IP cameras you wish to view on display.</p> <p>If the number of IP camera is less than the number of split screen, unused display cell will be displayed as grey color to indicate it's not being connected to any IP camera.</p> |
| <p>Full-screen</p>  | <p>Click this button to display video from IP cameras in full-screen mode. All control buttons will be hidden, only IP camera's video will be displayed.</p> <p>To leave full-screen mode, press 'Esc' key on your keyboard.</p> |
| <p>Camera Scan</p>  | <p>When you click this button, EdiView will display the video from one camera only at the same time, and switch to next camera's video after few seconds, and so on.</p> |
| <p>Snapshot</p>  | <p>Take a snapshot of selected IP camera and save the picture on your computer.</p> <p>When you click this button, the picture of IP camera selected in 'snapshot camera selection' dropdown menu will be saved.</p> |
| <p>EMAP</p>  | <p>Display the EMAP (Electronic map) image on camera view area, which indicates the position and orientation in physical environment of every IP camera.</p> <p>To set a picture as EMAP's background picture:</p> <p>Right-click on the EMAP display area, and you'll be prompted to select a picture on your computer:</p> |

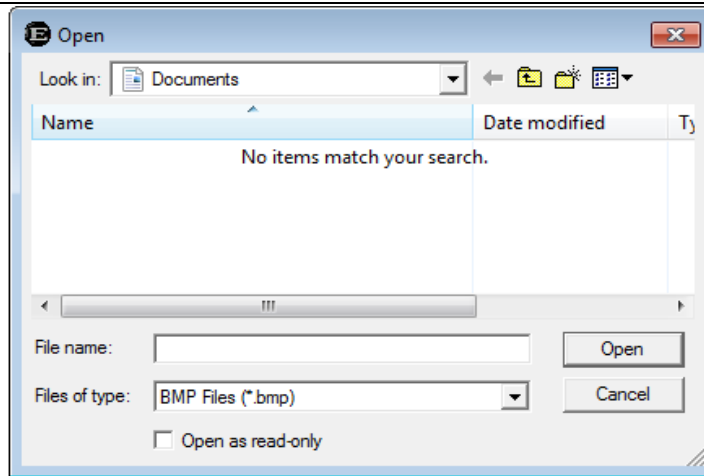



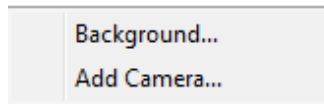

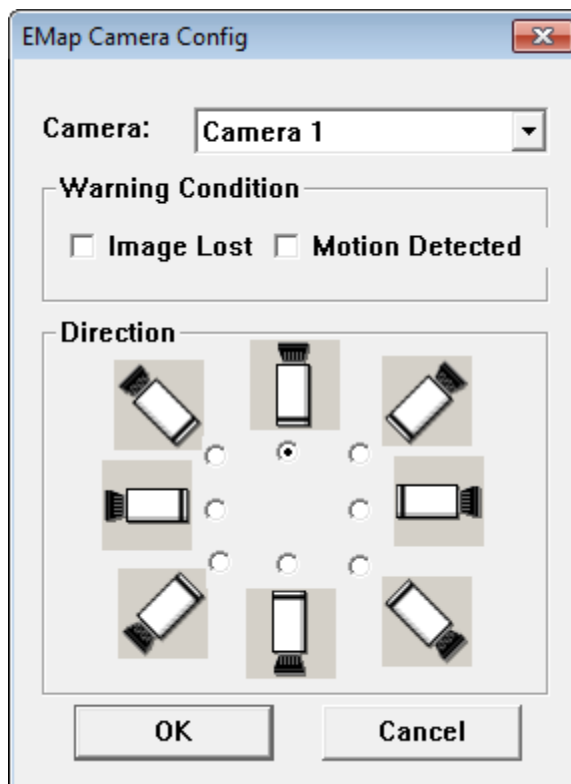

Select the file, and click 'Open' button to use the picture as background picture. To add a camera, right-click on the background picture and select 'Add Camera...'



A new window will appear:



Select the camera you wish to add from 'Camera' dropdown list, and check the box 'Image Lost' and / or

| | |
|--|---|
| | <p>'Motion Detected' if you want to get a warning message when image lost of motion is detected, then select the direction of camera icon, this will help you to remember the orientation of camera on the EMAP.</p> <p>After you click 'OK' button, a camera icon will appear on EMAP with its camera number indicated:</p>  <p>You can add more cameras to EMAP by repeating procedures listed above.</p> |
| <p>Configuration</p>  | <p>Enter EdiView configuration page. See next chapter for detailed instructions.</p> |
| <p>Playback</p>  | <p>Playback recorded video. A new video playback window will appear. See chapter III for detailed instructions.</p> |
| <p>Recording</p>  | <p>Start / stop video recording.</p> <p>When recording video, this button will appear as red.</p> |
| <p>Schedule</p>  | <p>Enable schedule recording. You must define schedule in advance before you can enable schedule recording.</p> |
| <p>Snapshot camera selection</p>  | <p>Here lists all IP cameras you have, select one camera from dropdown list for snapshot.</p> |

| | |
|---|--|
| Date / Time, Remaining Disk Space | Displays current date, time, and remaining disk storage space. |
| Exit  | Click this button to leave EdiView |

All camera's video will displayed in 'Camera View' area:

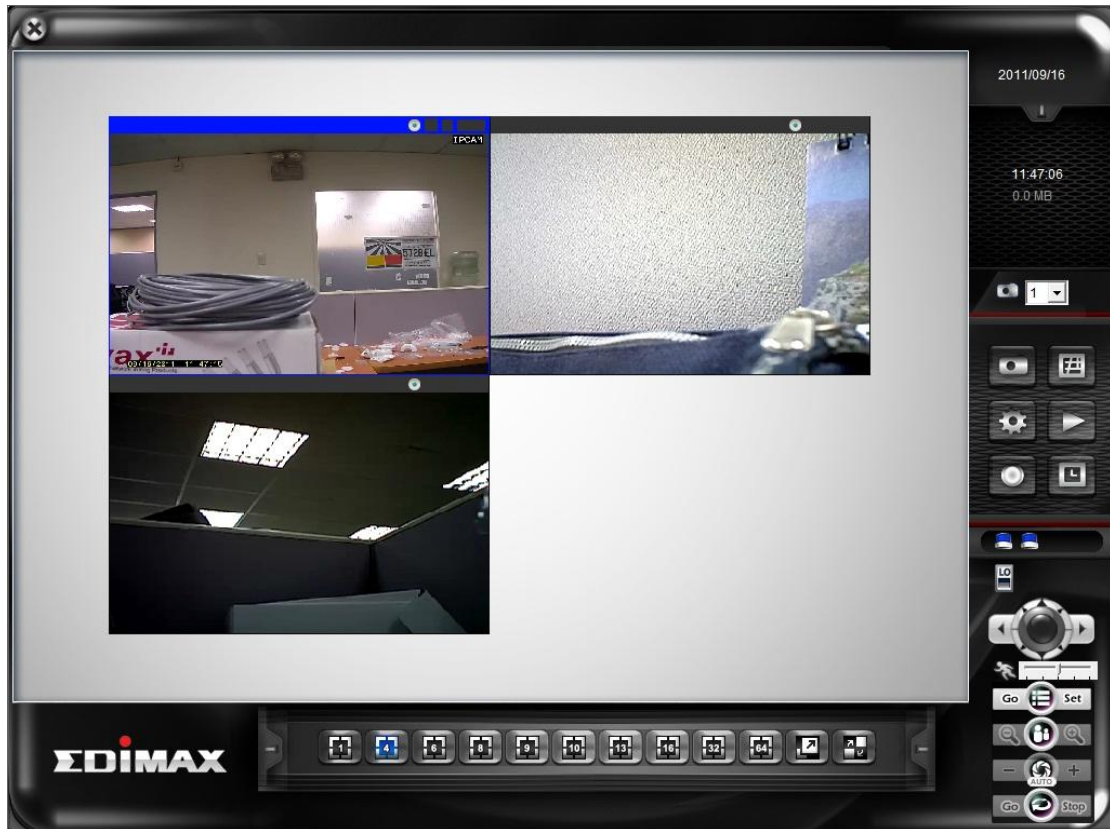





(This example picture shows a 4-split camera view with only 2 IP cameras configured)

To select an IP camera, click its video and it will be highlighted; some IP cameras support additional control, and a control panel will appear at the bottom-right area of EdiView :



The description of these items is listed as follow:

| Item | Description |
|---|--|
| Pan / Tilt control  | Click the direction arrow to control camera's pan / tilt. |
| Pan / Tilt speed  | Drag the slide bar to adjust the pan / tilt speed when you click pan / tilt control arrow. |
| Zoom  | Optical zoom control. Click + or - to control zoom level. |
| Exposure  | Exposure control. Click + or - to control exposure level. |
| Cruise control  | Click 'Go' button to start camera cruise and click 'Stop' button to stop cruise. |

4-3 Configuration

Before you can use EdiView, you must configure at least 1 IP cameras.

To enter configuration menu, click 'Configuration' button  in EdiView' main menu:

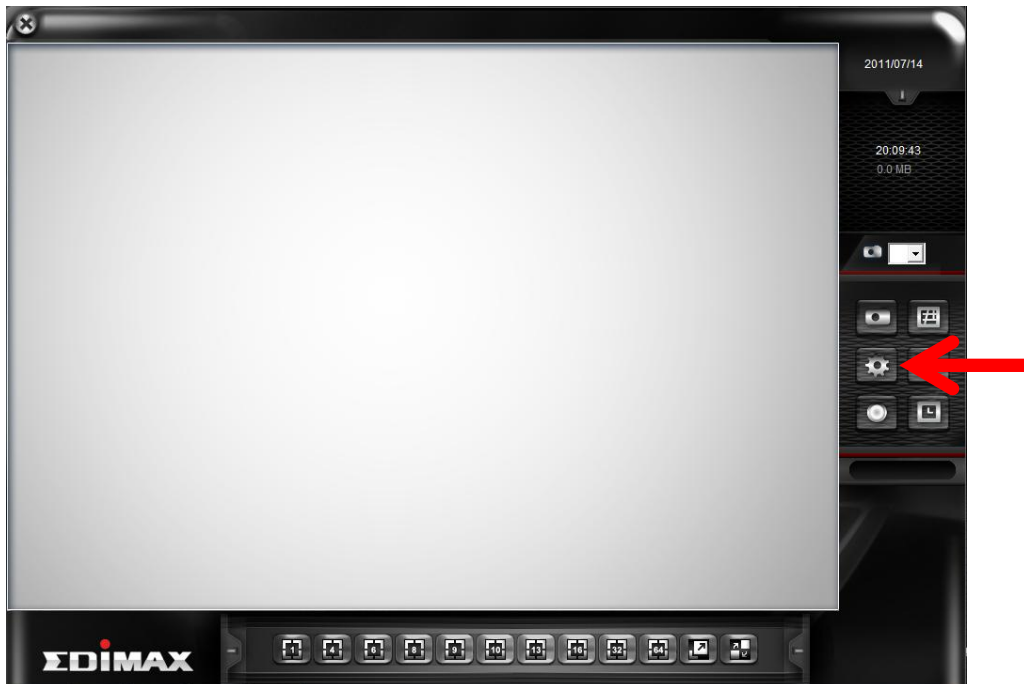

The configuration menu will appear. There are 6 sub menus in the configuration menu:

Device (Add or remove IP camera / video server)

Recording (Configure video recording)

System (Configure system-wide settings)

Schedule (Configure schedule recording)

Event (Configure event recording)

Security (Configure EdiView user list)

Detailed descriptions of every sub menu will be given in following chapters.

4-3-1 Device

You should configure at least one IP camera / video server before you can use EdiView , and you can manage all IP camera / video server here.

To add a new IP camera, click 'Add' button:

Device | Recording | System | Schedule | Event | Security

Camera List

| Index | Camera Name | IP Address | HTT... | Model |
|-------|-------------|------------|--------|-------|
|-------|-------------|------------|--------|-------|

Enable All | Disable All | Add



IP camera setup window will appear on the right:

Configure

Device Search

| IP Address | HTTP P... | Model | MAC Address |
|------------|-----------|-------|-------------|
|------------|-----------|-------|-------------|

Search View Image... Detail

IP Address: 192.168.10.77 HTTP Port: 80 Rtsp Port: 554

User: admin Password: 1234

Name: Model: IC-7000PT V2

Stream Type

MPEG4 MJPEG

Enable Camera

Detect Device Add to list

If your IP camera is located on local area network, click 'Search' button. Wait for few seconds or few minutes until the search is complete, and all IP cameras found on your local area network will be listed:

Configure

Device Search

| IP Address | HTTP P... | Model | MAC Address |
|-------------|-----------|------------|-----------------|
| 192.168.2.3 | 80 | IC-3015... | 00.0E.2E.44.6B. |

In this example, an IP camera has been found at IP address 192.168.2.3. If this is the IP camera you wish to add, click 'Add to list' button. You can repeat above procedures to add all IP cameras you wish to connect.

When an IP camera is found, you can also select it in the list and:

View Image: View the live image from selected IP camera.

Detail: Connect to selected IP camera's web configuration menu.

You can also select the video stream type you wish to use:

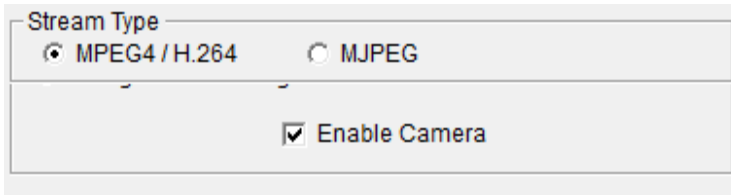

A configuration form titled 'Stream Type' with two radio buttons: 'MPEG4 / H.264' (selected) and 'MJPEG'. Below the radio buttons is a checkbox labeled 'Enable Camera' which is checked.

Check 'Enable Camera' to enable this camera is EdiView.

If the IP camera you wish to add is not located on local area network, you have to input the details of IP camera manually:

1. Input the network settings of IP camera, including IP address, HTTP port number, user name / password.

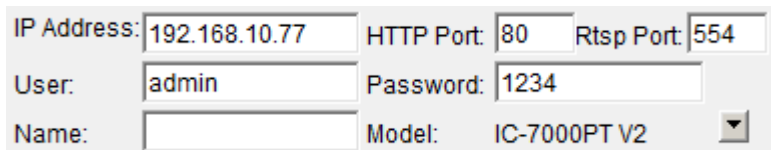

A form for manual IP camera configuration with the following fields: IP Address: 192.168.10.77, HTTP Port: 80, Rtsp Port: 554, User: admin, Password: 1234, Name: (empty), Model: IC-7000PT V2 with a dropdown arrow.

2. Click ▾ button (located at the right of 'Model' item), and select the brand and model of the IP camera you wish to add. You can also click 'Detect Device' to detect the brand of model of IP camera if you know its IP address.



A 'Model List' form with two panes. The left pane contains 'EdiMAX'. The right pane is a list box containing 'SIM series', 'SIU series' (highlighted in blue), and 'SVS series'.

After you found an IP camera of add it manually, click 'Add to list' button and the IP camera will be listed in EdiView and ready to use:

| Camera List | | | | |
|-------------------------------------|-------------|-------------|--------|----------|
| Index | Camera Name | IP Address | HTT... | Model |
| <input checked="" type="checkbox"/> | Camera1 | 192.168.2.3 | 80 | IC-3015V |

Every IP camera has a check box, indicating if it is enabled. If a camera is not enabled, it will not be displayed in EdiView's video view.

You can also manage IP camera list by the following function:

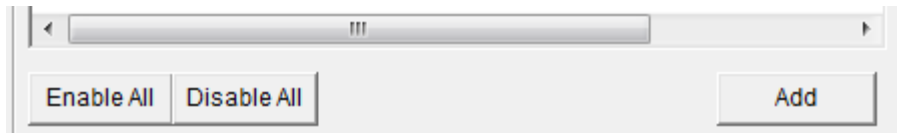

Enable All: Enable all IP cameras in the list.

Disable All: Disable all IP cameras in the list.

Remove: Remove selected IP camera.

When you selected an IP camera in the list, you can also click 'Update to list' button to update its information, like IP address and user name / password.

4-3-2 Recording

You can specify the video recording behavior for all IP cameras: recording all the time, motion detection, or not recording at all.

Please note that if you don't have any IP camera added in the camera list, you'll not be able to enter this setup menu.



Use the mouse to click blocks on the grid pattern to assign the areas you wish EdiView to detect / ignore motion. EdiView will detect motion for areas which are **NOT** covered by blocks only.

To add or erase blocks:



To add blocks, click + button; to erase blocks, click - button. Click 'Reset' button to reset motion detection blocks to default setting. You can also change the color of block if its color is similar to the IP camera's video and makes you hard to identify the blocks by click the color brick between + and - button:

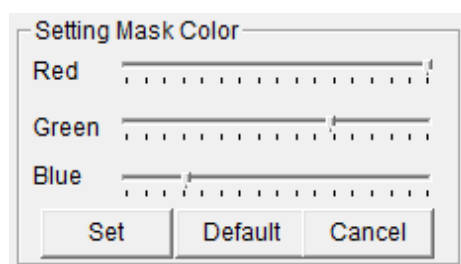

Drag red, green, and blue slide bar to set color, and click 'Set' button to save changes, click 'Default' button to reset settings, and click 'Cancel' to leave this menu without saving changes.

You also have to setup sensitivity:

Sensitivity:

Drag the slide bar to setup sensitivity level from 1 to 10. Larger number indicates more sensitivity.

To apply this motion detection settings to all IP cameras, click 'Apply to All Cameras' button.

When you finish setting, click 'OK' button to save changes you made, or click 'Cancel' button to discard all settings you made.

4-3-3 System

You can configure system-wide configurations in this sub menu.

The screenshot shows a configuration window with several sections:

- Host Name:** A text box containing 'EdiView'.
- Camera Caption:** Radio buttons for 'No', 'Camera ID', and 'Camera ID + Camera Name' (selected).
- Data Storage Setting:** Includes 'Enable Recycle' (checkbox), 'Alarm Space' (200 MB), and a table for 'Locations' with columns for Path, Available Space, Total Space, and Safe Space. Below the table is a 'Remove' button and a 'Select a location' section with a 'Browse' button and 'Safe Space' (1000 MB) and 'Add/Modify' buttons.
- Start-up Condition:** Checkboxes for 'Auto run, when Windows start', 'Start program in minimum', and 'Auto record'.
- Auto Login:** Text boxes for 'User ID' and 'Password', and a checkbox for 'Full screen view when auto login'.
- Alarm Transmitted e-Mail:** Fields for 'SMTP Server', 'Sender', 'Receiver', 'CC', and 'Subject'. Includes a 'Number of attachments' (1) and 'Email alerts Interval' (30 Second(s)).
- SMTP Authentication:** Text boxes for 'User' and 'Password'.
- Snapshot Image File Location:** A text box with 'C:\Program Files\EdiView\Snapshot' and a 'Browse' button.
- Camera Scan Interval:** A text box with '3' and 'Second(s)'. Includes a 'Connection Retry' section with 'Retry 3 times' (selected) and 'Always retry'.

The descriptions of every setup items are listed as follow:

| Item | Description |
|----------------|---|
| Host Name | Input the host name of this computer. This will help you to identify this computer which is running EdiView on network. |
| Camera Caption | Add a text caption on camera view or not: |

| | |
|----------------------|--|
| | <p>No: Do not display caption on camera view</p> <p>Camera ID: Display Camera's ID number</p> <p>Camera ID + Camera Name: Display both camera's ID and camera's name.</p> |
| Data Storage Setting | <p>Setup hard disk data storage:</p> <p>Enable Recycle: Check this box and the latest recording video will overwrite oldest recorded video file automatically. If you didn't check this box, EdiView will stop recording when data storage space is full.</p> <p>Alarm Space: When data storage space is less than the size you specified here, you'll receive an alarm message to notify you should do something to prevent from running out of storage space.</p> <p>Locations: Lists all data storage space configured. You can all / modify spaces below.</p> <p>Browse: Select a drive or folder on your computer for recording data storage. You can also create a new folder when you're prompted to select a drive or folder on your computer.</p> <p>Safe Space: Specify the lower limit of storage space you specified. When remaining storage space is less than the size you specified here, EdiView will stop recording**.</p> <p>Add/Modify: You can click this button to add the drive / folder you specified above to storage space list, or select an existing storage space in the list to change its parameters then click this button to update its parameter.</p> <p>Remove: Select a pre-defined storage space and click this button to remove it from the list.</p> |
| Alarm Space | When data storage space is less than the size |

| | |
|--------------------------|---|
| | <p>you specified here, you'll receive an alarm message to notify you should do something to prevent from running out of storage space.</p> |
| Start-up Condition | <p>Select the behavior of EdiView when computer starts up. You can select multiple options you want to use:</p> <p>Auto run, when Windows start: Check this box and EdiView will run automatically when computer starts.</p> <p>Start program in minimum: Start EdiView as minimized window.</p> <p>Auto record: Start video recording automatically when EdiView starts.</p> <p>If you want to start recording automatically, remember to use 'Auto Login' function.</p> |
| Auto Login | <p>Input the user ID and password to login EdiView automatically. This function is useful when you want to start recording automatically when computer starts.</p> <p>User ID: Input user ID used to login EdiView, must have adequate privileges to perform the action you wish to execute.</p> <p>Password: Input user's password.</p> <p>Full screen view when auto login: Switch to full screen display mode when auto login.</p> |
| Alarm Transmitted e-Mail | <p>Send an E-mail notification with picture when alarm is triggered (motion is detected):</p> <p>SMTP Server: Input the IP address or host name of SMTP server (mail server) you wish to use.</p> <p>Sender: Input the sender's E-mail address in sent email. This will help you to identify the E-mail sent by EdiView. For some SMTP servers, you must set a sender E-mail address of the</p> |

| | |
|----------------------|---|
| | <p>same domain name.</p> <p>Receiver: Input the E-mail receiver's address here.</p> <p>CC: input additional E-mail receiver's address here.</p> <p>Subject: Input the subject of sent E-mail. This will also help you to identify the E-mail sent by EdiView .</p> <p>Number of attachments: Input the number of snapshot attachments that will sent with E-mail, so you can see the image of camera by E-mail (1 to 10 attachments only).</p> <p>Email alerts Interval: Input the time interval between two E-mails. A new E-mail will not be sent within the interval you specified here even a new event is detected.</p> <p>User: Input the user name for SMTP authentication. Input only when it's required by your SMTP server, you can leave it blank if it's not required.</p> <p>Password: Input the password used by SMTP authentication.</p> |
| Camera Scan Interval | Input the time interval to wait between camera scan. |
| Connection Retry | <p>Decides the behavior when EdiView lost communication with IP camera:</p> <p>Retry: Retry for the time you specified here.</p> <p>Always retry: Retry to connect to IP camera until successfully connected.</p> |

When you finishes setting, click 'OK' button to save changes you made, or click 'Cancel' button to discard all settings you made.

A new window will appear on the right:

You can configure a new schedule recording job here. The descriptions of every setup items are listed as follow:

| Item | Description |
|-----------------|--|
| Weekly Schedule | <p>Select the time period in a week of this schedule. There are total 48 x 7 blocks in a week schedule, where every block represents half an hour.</p> <p>You can use mouse to click on the block to add or delete time period. If recording is activated in that time period, the block will appear as light blue ■. If recording is NOT activated in that time period, the block will appear as dark blue ■.</p> <p>To add or delete a time period, select 'ADD' or</p> |

| | |
|--------------------|--|
| | 'DEL' first, then click the time period block. |
| Events | <p>Select the event to trigger recording:</p> <p>Round-The-Clock: Recording is time-activated (according to schedule).</p> <p>Motion Detection: Recording is motion-activated.</p> <p>DI Input: Recording is activated by DI (Digital Input) signal located on IP camera. IP camera must have DI port and not every IP camera is equipped with DI.</p> |
| Dedicated Schedule | <p>If you just want to add a new recording schedule between certain time and this schedule will only happen once but not every week, you can use this function to specify a time period.</p> <p>Select 'Start' and 'End' date / time, and click 'Add/Modify' button to add the time period to the list. You can also select an existing time period and make changes, and click 'Add / Modify' button to save changes.</p> <p>To remove an existing schedule, select an existing schedule, and then click 'Remove' button.</p> |
| Comment | You can input some text to help you to memorize the purpose of this schedule |
| Cameras/Devices | Check all IP cameras that will be activated by this schedule. |
| Add to list | Click this button to add this schedule to the list. |

When you finishes setting, click 'OK' button to save changes you made, or click 'Cancel' button to discard all settings you made.

4-3-5 Event

EdiView can send you an alarm E-Mail message so you can know something happened on the IP camera (motion detected, video lost, or connection lost). A sound can be played to notify the operator at the computer where EdiView is installed, too.

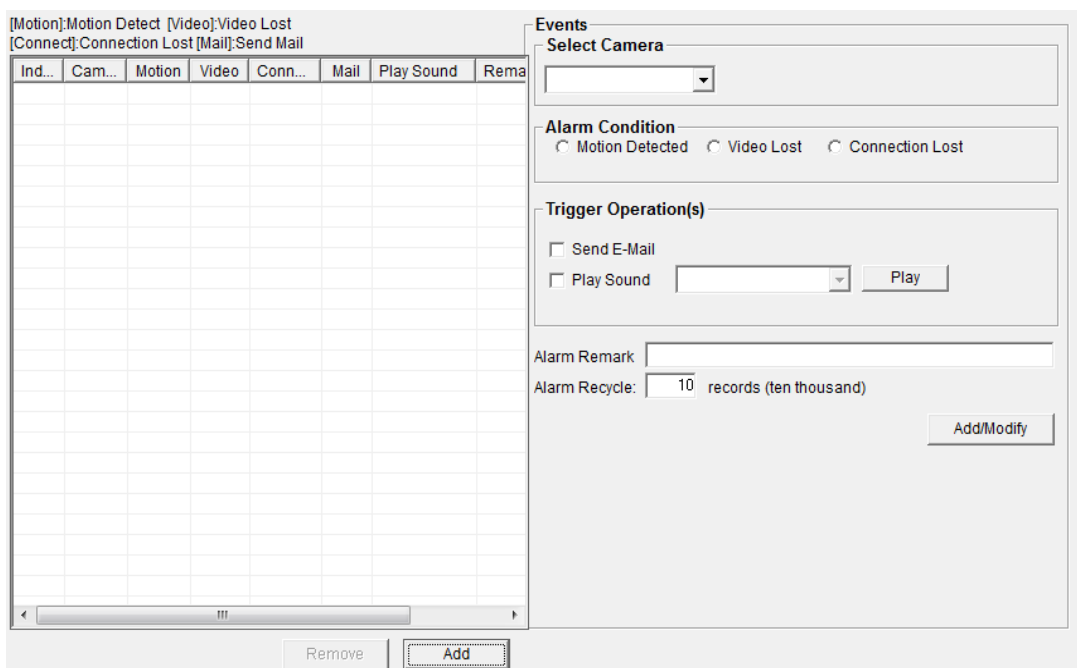

To add a new event, click 'Add' button, and a new window will appear on the right for you to setup a new event.

To remove an existing event, select an event in the list and click 'Remove' button.

The descriptions of every setup items are listed as follow:

| Item | Description |
|-----------------|---|
| Select Camera | Select the IP camera to define its event detail. |
| Alarm Condition | <p>Define the type of event which will trigger an alarm:</p> <p>Motion detected: Alarm will be triggered when motion is detected at this IP camera.</p> <p>Video lost: Alarm will be triggered when video server's external camera signal is lost.</p> <p>Connection Lost: Alarm will be triggered when network connection to this IP camera is lost.</p> <p>You can select one alarm condition only here. If</p> |

| | |
|----------------------|---|
| | you want to specify more than one alarm condition for the same IP camera, |
| Trigger Operation(s) | <p>Define the action which will be taken when alarm is triggered:</p> <p>Send E-Mail: an E-mail will be sent when alarm is triggered.</p> <p>Play Sound: Play a sound on the computer where EdiView is installed. To add a new sound file, copy the .wav file to the following directory:</p> <p>C:\Program Files\EdiView\media</p> <p>You can click 'Play' button to play the sound file you selected.</p> |
| Alarm Remark | You can input descriptive text here to help you to remember the purpose of this event. |
| Alarm Recycle | ** |

When you finish setting, click 'Add/Modify' button to add this event to the list.

4-3-6 Security

You can add or remove users which is allowed to access to EdiView.

Administrator's user ID is always be 'admin' and cannot be changed. You can only change admin's password in Administrator's 'Password' and 'Confirm Password' field.

Administrator

Password:

Confirm Password

Please input the same password in both fields for confirmation.

To add a user, click 'Add' button, a new window will appear on the right:

User Information

User ID: Description:

Password: Confirm Password

User Privilege

View

- Multi-Camera View Operation
- Camera Map Operation

System Operation (Start/Stop)

- Scheduling
- Recording
- Playback

Camera List

Select all | Select none

| | | |
|-------------------------------------|------------------------------------|--------------------------|
| <input type="checkbox"/> Camera 01 | <input type="checkbox"/> Camera 17 | <input type="checkbox"/> |
| <input type="checkbox"/> Camera 02 | <input type="checkbox"/> Camera 18 | <input type="checkbox"/> |
| <input type="checkbox"/> Camera 03 | <input type="checkbox"/> Camera 19 | <input type="checkbox"/> |
| <input type="checkbox"/> Camera 04 | <input type="checkbox"/> Camera 20 | <input type="checkbox"/> |
| <input type="checkbox"/> Camera 05 | <input type="checkbox"/> Camera 21 | <input type="checkbox"/> |
| <input type="checkbox"/> Camera 06 | <input type="checkbox"/> Camera 22 | <input type="checkbox"/> |
| <input type="checkbox"/> Camera 07 | <input type="checkbox"/> Camera 23 | <input type="checkbox"/> |
| <input type="checkbox"/> Camera 08 | <input type="checkbox"/> Camera 24 | <input type="checkbox"/> |
| <input type="checkbox"/> Camera 09 | <input type="checkbox"/> Camera 25 | <input type="checkbox"/> |
| <input type="checkbox"/> Camera 10 | <input type="checkbox"/> Camera 26 | <input type="checkbox"/> |
| <input type="checkbox"/> Camera ... | <input type="checkbox"/> Camera 27 | <input type="checkbox"/> |
| <input type="checkbox"/> Camera 12 | <input type="checkbox"/> Camera 28 | <input type="checkbox"/> |
| <input type="checkbox"/> Camera 13 | <input type="checkbox"/> Camera 29 | <input type="checkbox"/> |
| <input type="checkbox"/> Camera 14 | <input type="checkbox"/> Camera 30 | <input type="checkbox"/> |
| <input type="checkbox"/> Camera 15 | <input type="checkbox"/> Camera 31 | <input type="checkbox"/> |
| <input type="checkbox"/> Camera 16 | <input type="checkbox"/> Camera 32 | <input type="checkbox"/> |

The descriptions of every setup items are listed as follow:

| Item | Description |
|-----------------------------|--|
| User ID | Input the user ID used to login EdiView |
| Description | Input any descriptive text to help you to memorize the purpose of this user ID. |
| Password / Confirm Password | Input this user's password in both fields. |
| User Privilege | Defines the privilege of this user (Check the boxes that you wish to give privilege): Multi-Camera View Operation: Allows multi-camera view. Camera Map Operation: Allows to show E-MAP. Scheduling: User can start or stop schedule recording. Recording: User can start or stop video recording. Playback: User can playback saved video. |
| Camera List | Select IP cameras you wish to allow this user to view. |

When you finishes setting, click 'Add/Modify' button to add this new user.

You can also select an existing user and change his / her user information, then click 'Add / Modify' button to save changes for this user.

4-4 Video Playback

To view recorded video, you can click 'Playback' button in EdiView's main screen:

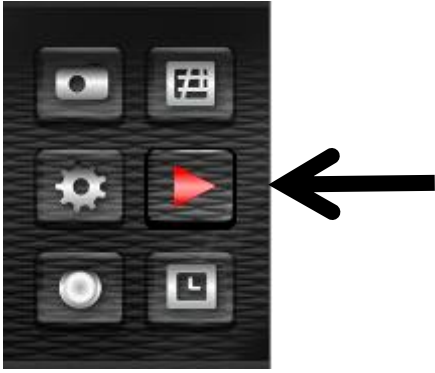

A new window will appear:



To play a recorded video, you can use one of following two functions:

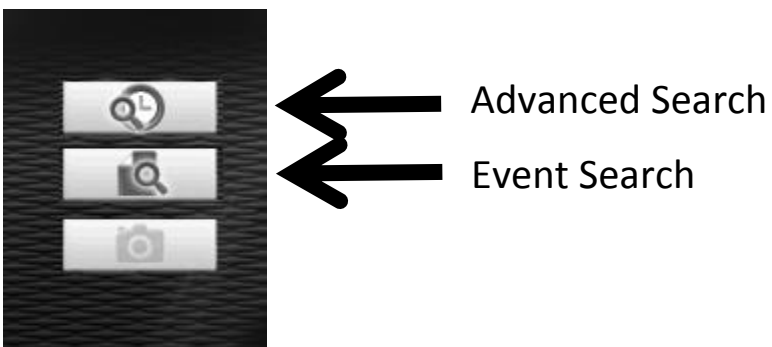

Please refer to following chapters for detailed instructions of every search mode.

4-4-1 Advanced Search

You can search for recorded video within specific time period, and get a list of record modes of all IP cameras.

Advance Search Dialog

Time Period

Start Time: 2011/07/06 --- 13

Stop Time: 2011/07/06 --- 13

Round Clock

Motion Detect

Digital Input

SEARCH

Uncheck All

Camera ID

Checked Count

Play

Cancel

When you enter this menu, please specify start time and stop time:

Time Period

Start Time: 2011/07/06 --- 13

Stop Time: 2011/07/06 --- 13

SEARCH

DATE

Hour in a day

(You can input 0 - 23 in 'Hour in a day' field by keyboard directly).

When you finish, click 'SEARCH' button to search for recorded video, and you'll get a similar output like this:

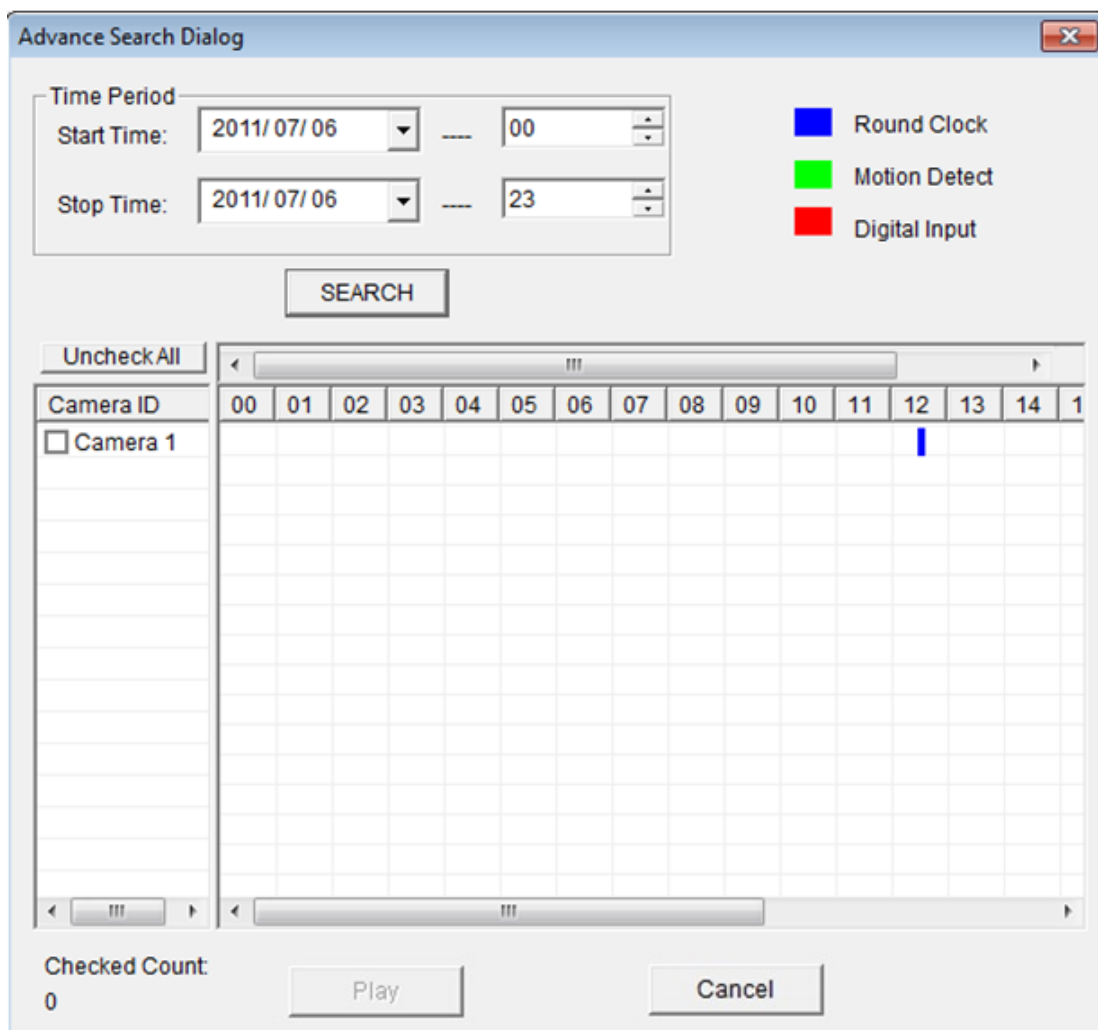

In this picture, a recorded video of 'Camera 1' has been found at 12 o'clock. A blue mark indicates it's a 'Round Clock' (manual) recording.

Other record type include:

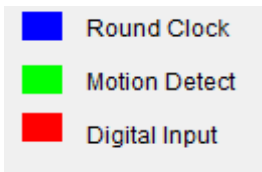

Blue: Manual Recording

Green: Recording is triggered by motion

Red: Recording is triggered by Digital Input

To view the video, check the box of camera ID, then click play button.

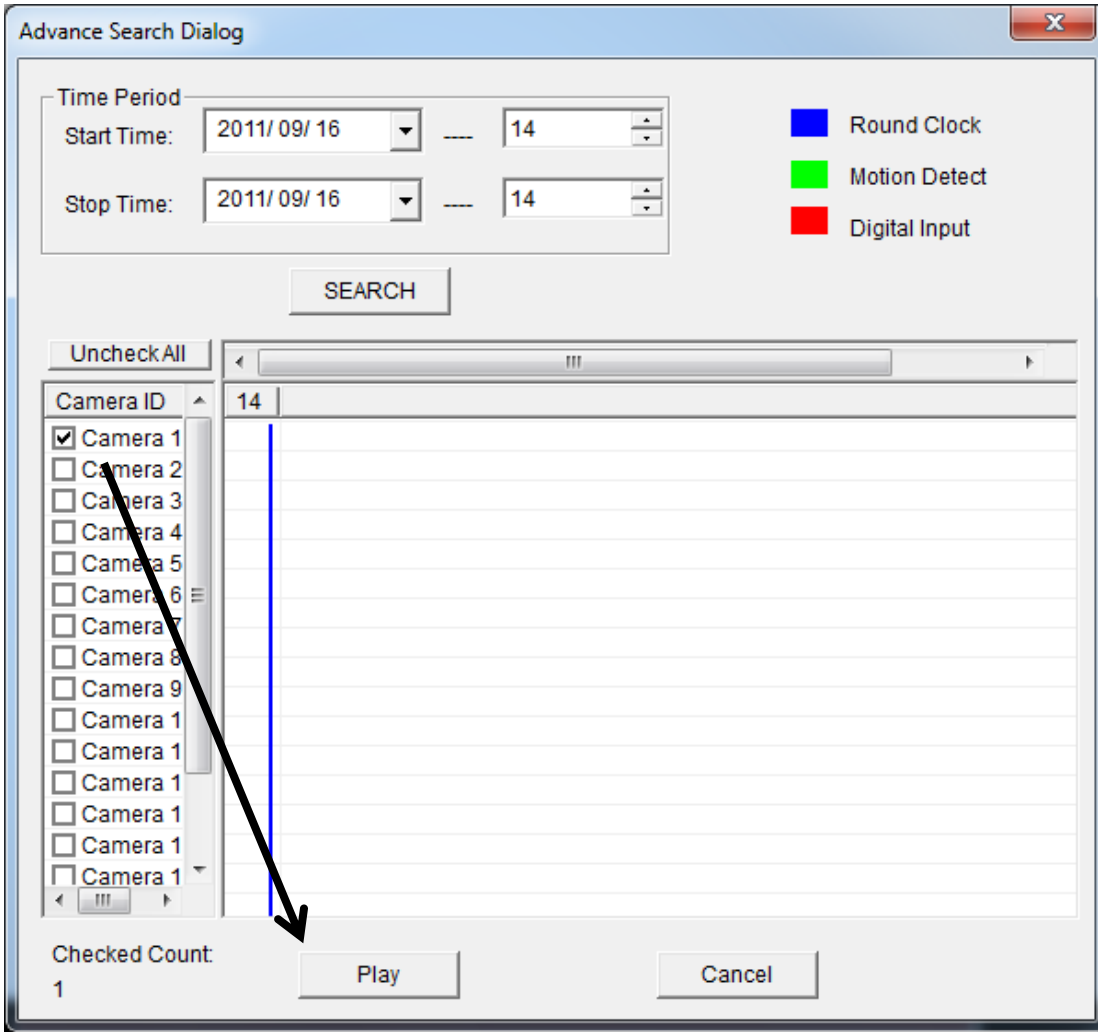

And the video will be prepared for playback.



4-4-2 Event Search

You can search for video for playback by triggering event: round the clock, motion detection, or digital input.

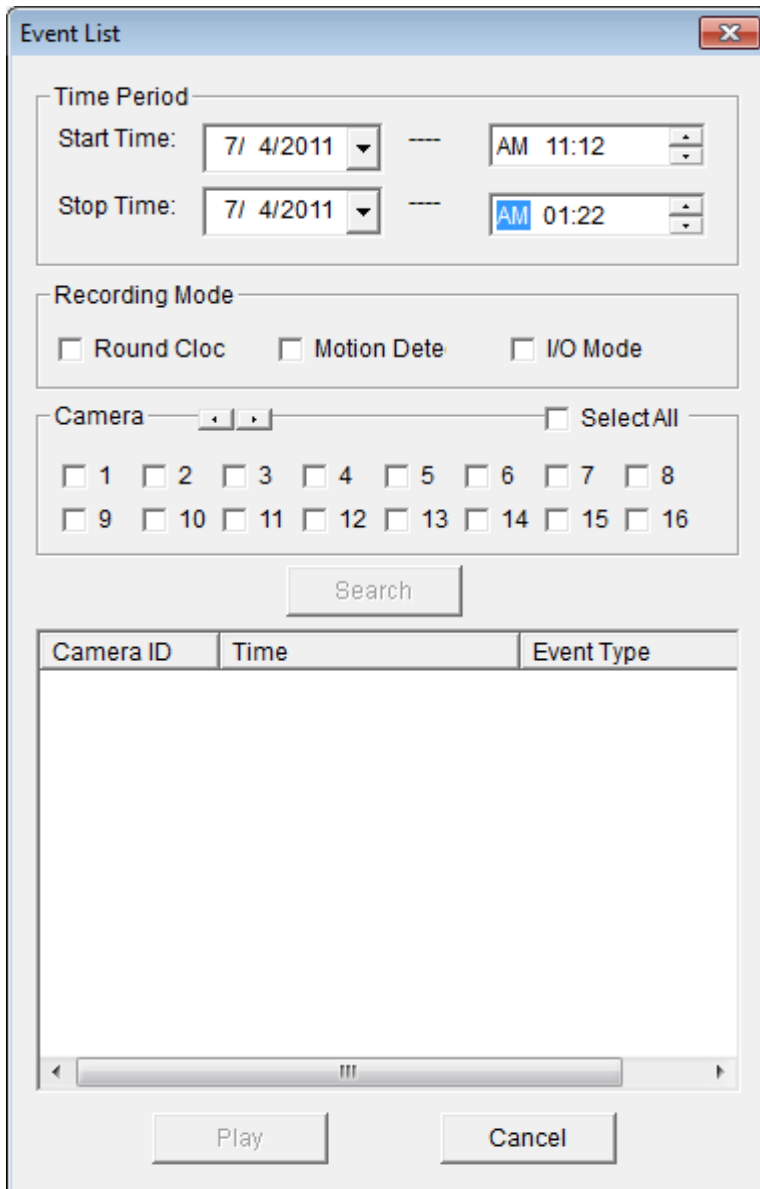

To search for video, you have to specify:

- 1) starting and ending time for video searching in 'Start time' and 'Stop time' field
- 2) Recording mode: Round Clock, Motion Detection, and I/O Mode (Digital Input). You can check all boxes you wish to search for.
- 3) Camera: You can check all cameras you wish to search for video. To select camera ID more than 16, click right or left button to select camera ID up to 64, or click 'Select All' to select all cameras.

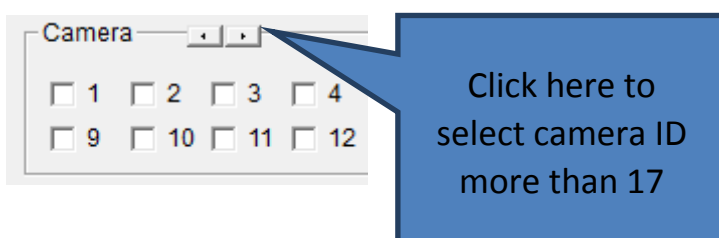

When you finish, click 'Search' button to search for recorded video, and a list similar to this will appear:

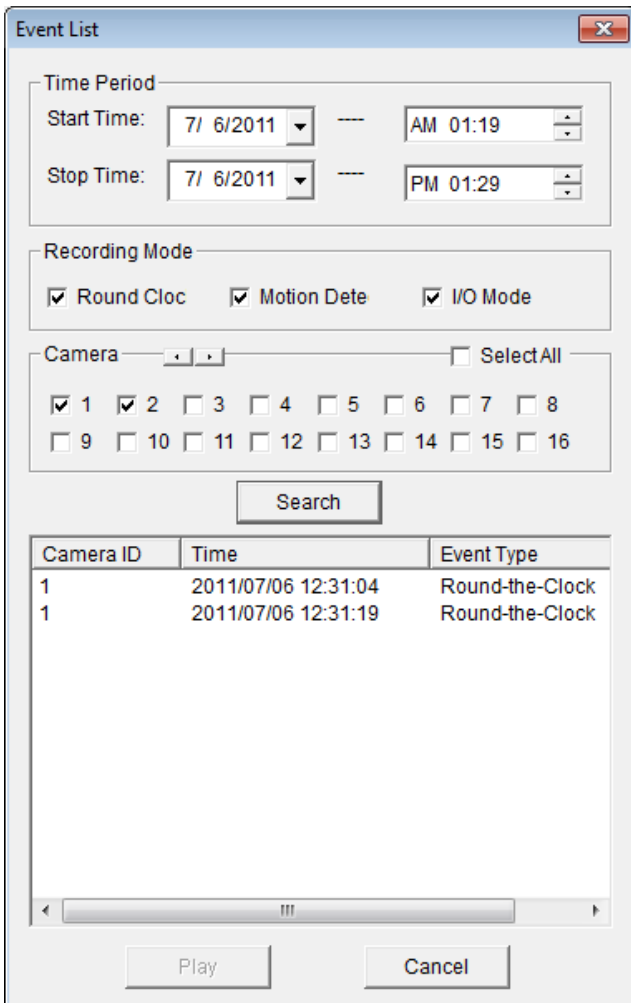

The 'Event List' window contains the following sections:

- Time Period:** Start Time: 7/ 6/2011 AM 01:19; Stop Time: 7/ 6/2011 PM 01:29.
- Recording Mode:** Round Clocl, Motion Dete, I/O Mode.
- Camera:** Select All (unchecked). Camera 1-16 checkboxes: 1 and 2 are checked.
- Search:** A button labeled 'Search'.
- Table:** A table with columns 'Camera ID', 'Time', and 'Event Type'.

| Camera ID | Time | Event Type |
|-----------|---------------------|-----------------|
| 1 | 2011/07/06 12:31:04 | Round-the-Clock |
| 1 | 2011/07/06 12:31:19 | Round-the-Clock |
- Buttons:** 'Play' and 'Cancel' buttons at the bottom.

You can select the video clip you wish to play, and click 'Play' button.







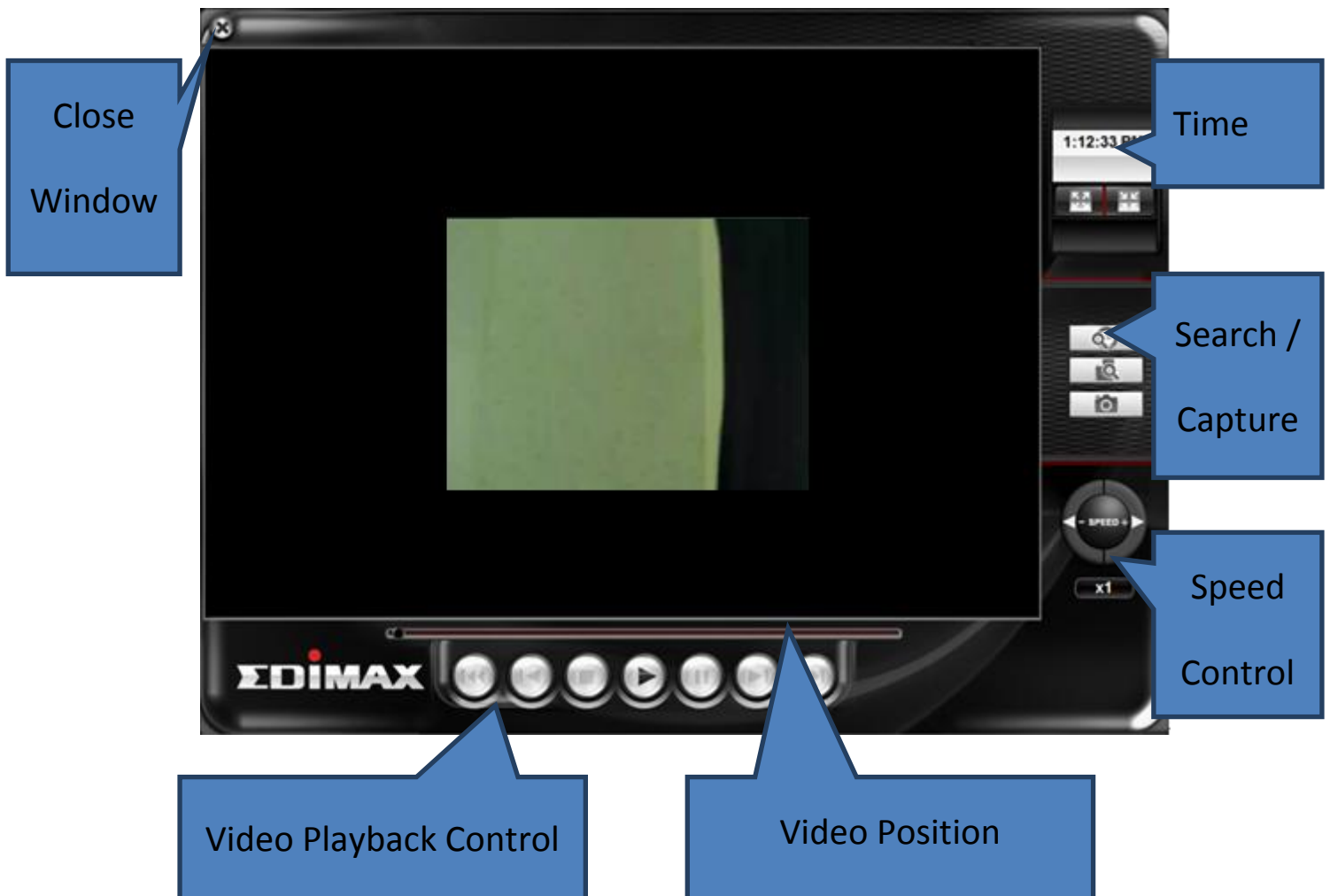





4-4-3 Video Playback

When a video is loaded, the video playback screen will look like this:



The descriptions of every item are listed as follow:

| Item | Description |
|------------------------|--|
| Close Window | Click X mark to close video playback window. |
| Video Playback Control | <p>You can use following buttons to control video playback:</p> <ul style="list-style-type: none">  Skip to the beginning position of video  Skip to previous video frame  Stop video playback  Start video playback |

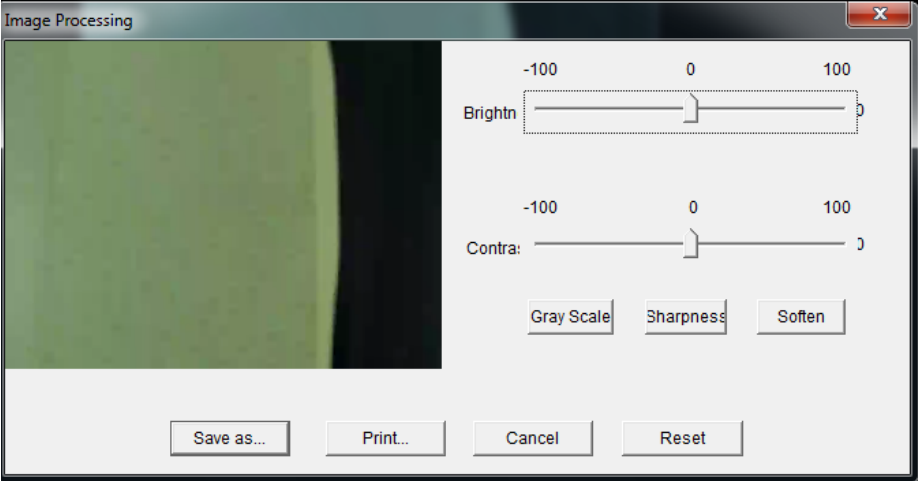
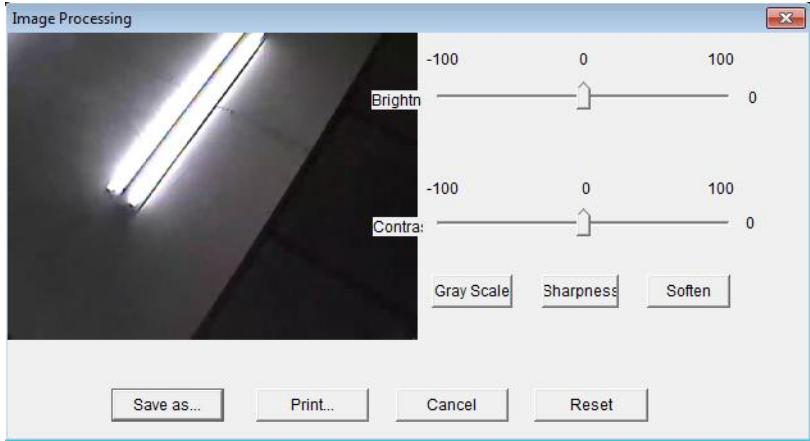
| | |
|------------------|--|
| | <p> Pause a playing video, click 'Play' to resume video playback</p> <p> Skip to next video frame</p> <p> Skip to the ending position of video clip</p> |
| Speed Control | <p>When video is stopped, you can click + or – button to adjust video playback speed: from 1/4 to 4x speed.</p> <p><i>You cannot adjust video playback speed when video is playing.</i></p> |
| Search / Capture | <p>Click  or  button to search for video (see chapter 3-2 / 3-3 for detailed instruction).</p> <p>Click  button to take a snapshot picture of current video playback position. A new window will appear:</p>   <p>You can adjust image brightness / contrast by dragging corresponding slide bar, or click 'Gray Scale', 'Sharpness', 'Soften' to adjust image parameters.</p> |

| | |
|------|---|
| | <p>You can click 'Save as' button to save current image (you'll be prompted for image saving location), or click 'Print' to print current image to printer.</p> <p>To back to previous menu, click 'Cancel'; click 'Reset' to reset image parameters back to default value.</p> |
| Time | <p>Current time will be displayed here.</p> <p>You can click '🔍' button to display video zoom in, or click '🔍' button to display video zoom out.</p> |

Chapter V Troubleshooting

Please don't panic when you found this IP Camera is not working properly. Before you send this IP Camera back to us, you can do some simple checks to save your time:

| Problem description | Possible solution(s) |
|--|---|
| Can't connect to IP Camera | <ol style="list-style-type: none"> 1) Please check the IP address of IP Camera again. 2) Please make sure the network cable is correctly connected to your local area network. 3) Please make sure power cable is correctly connected to IP Camera. 4) Please make sure IP Camera is switched on (the LED lights on IP Camera will light up). |
| No IP Camera found | <ol style="list-style-type: none"> 1) 'Auto search' function only works on IP Cameras located on local area network. |
| No image | <ol style="list-style-type: none"> 1) If the place where IP camera is installed is too dark, try to add some lights when possible. 2) Check if there's anything covering the lens. |
| RTSP URL | <ol style="list-style-type: none"> 1) Main Stream (H.264/MPEG4) RTSP://IP address :RTSP port/stream1 2) MJPEG RTSP://IP address :RTSP port/stream2 3) Mobile View RTSP://IP address :RTSP port/mobile |
| Complete uninstall EdiView RS-64 (64 channel Viewer) | <ol style="list-style-type: none"> 1. Uninstall "EdiView " on control panel in Window OS 2. If step one did not remove "EdiView ", you need to manually remove" SetupEdiview " *3. Remove MSDE (Microsoft SQL Server Desktop Engine) if necessary* |

Federal Communication Commission Interference Statement

This equipment has been tested and found to comply with the limits for a Class B digital device, pursuant to Part 15 of FCC Rules. These limits are designed to provide reasonable protection against harmful interference in a residential installation. This equipment generates, uses, and can radiate radio frequency energy and, if not installed and used in accordance with the instructions, may cause harmful interference to radio communications. However, there is no guarantee that interference will not occur in a particular installation. If this equipment does cause harmful interference to radio or television reception, which can be determined by turning the equipment off and on, the user is encouraged to try to correct the interference by one or more of the following measures:

1. Reorient or relocate the receiving antenna.
2. Increase the separation between the equipment and receiver.
3. Connect the equipment into an outlet on a circuit different from that to which the receiver is connected.
4. Consult the dealer or an experienced radio technician for help.

FCC Caution

This device and its antenna must not be co-located or operating in conjunction with any other antenna or transmitter. This device complies with Part 15 of the FCC Rules. Operation is subject to the following two conditions: (1) this device may not cause harmful interference, and (2) this device must accept any interference received, including interference that may cause undesired operation. Any changes or modifications not expressly approved by the party responsible for compliance could void the authority to operate equipment.

Federal Communications Commission (FCC) Radiation Exposure Statement

This equipment complies with FCC radiation exposure set forth for an uncontrolled environment. In order to avoid the possibility of exceeding the FCC radio frequency exposure limits, human proximity to the antenna shall not be less than 2.5cm (1 inch) during normal operation.

Federal Communications Commission (FCC) RF Exposure Requirements

SAR compliance has been established in the laptop computer(s) configurations with PCMCIA slot on the side near the center, as tested in the application for certification, and can be used in laptop computer(s) with substantially similar physical dimensions, construction, and electrical and RF characteristics. Use in other devices such as PDAs or lap pads is not authorized. This transmitter is restricted for use with the specific antenna tested in the application for certification. The antenna(s) used for this transmitter must not be co-located or operating in conjunction with any other antenna or transmitter.

R&TTE Compliance Statement

This equipment complies with all the requirements of DIRECTIVE 1999/5/EC OF THE EUROPEAN PARLIAMENT AND THE COUNCIL of March 9, 1999 on radio equipment and telecommunication terminal equipment and the mutual recognition of their conformity (R&TTE). The R&TTE Directive repeals and replaces in the directive 98/13/EEC (Telecommunications Terminal Equipment and Satellite Earth Station Equipment) As of April 8, 2000.

Safety

This equipment is designed with the utmost care for the safety of those who install and use it. However, special attention must be paid to the dangers of electric shock and static electricity when working with electrical equipment. All guidelines of this and of the computer manufacture must therefore be allowed at all times to ensure the safe use of the equipment.

EU Countries Intended for Use

The ETSI version of this device is intended for home and office use in Austria, Belgium, Bulgaria, Cyprus, Czech, Denmark, Estonia, Finland, France, Germany, Greece, Hungary, Ireland, Italy, Latvia, Lithuania, Luxembourg, Malta, Netherlands, Poland, Portugal, Romania, Slovakia, Slovenia, Spain, Sweden, Turkey, and United Kingdom. The ETSI version of this device is also authorized for use in EFTA member states: Iceland, Liechtenstein, Norway, and Switzerland.

EU Countries Not Intended for Use

None

EU Declaration of Conformity

- English:** This equipment is in compliance with the essential requirements and other relevant provisions of Directive 2004/108/EC, 2006/95/EC.
- French:** Cet équipement est conforme aux exigences essentielles et autres dispositions de la directive 2004/108/EC, 2006/95/EC.
- Czechian:** Toto zařízení je v souladu se základními požadavky a ostatními příslušnými ustanoveními směrnic 2004/108/EC, 2006/95/EC.
- Polish:** Urządzenie jest zgodne z ogólnymi wymaganiami oraz szczególnymi warunkami określonymi Dyrektywą UE 2004/108/EC, 2006/95/EC.
- Romanian:** Acest echipament este în conformitate cu cerințele esențiale și alte prevederi relevante ale Directivei 2004/108/EC, 2006/95/EC.
- Russian:** Это оборудование соответствует основным требованиям и положениям Директивы 2004/108/EC, 2006/95/EC.
- Magyar:** Ez a berendezés megfelel az alapvető követelményeknek és más vonatkozó irányelveknek 2004/108/EC, 2006/95/EC
- Türkçe:** Bu cihaz 2004/108/EC, 2006/95/EC direktifleri zorunlu istekler ve diğer hükümlerle ile uyumludur.
- Ukrainian:** Обладнання відповідає вимогам і умовам директиви 2004/108/EC, 2006/95/EC.
- Slovakian:** Toto zariadenie spĺňa základné požiadavky a ďalšie príslušné ustanovenia smerníc 2004/108/EC, 2006/95/EC.
- German:** Dieses Gerät erfüllt die Voraussetzungen gemäß den Richtlinien 2004/108/EC, 2006/95/EC.
- Spanish:** El presente equipo cumple los requisitos esenciales de la Directiva 2004/108/EC, 2006/95/EC.
- Italian:** Questo apparecchio è conforme ai requisiti essenziali e alle altre disposizioni applicabili della Direttiva 2004/108/EC, 2006/95/EC.
- Dutch:** Dit apparaat voldoet aan de essentiële eisen en andere van toepassing zijnde bepalingen van richtlijn 2004/108/EC, 2006/95/EC.
- Portugese:** Este equipamento cumpre os requisitos essenciais da Directiva 2004/108/EC, 2006/95/EC.
- Norwegian:** Dette utstyret er i samsvar med de viktigste kravene og andre relevante regler i Direktiv 2004/108/EC, 2006/95/EC.
- Swedish:** Denna utrustning är i överensstämmelse med de väsentliga kraven och övriga relevanta bestämmelser i direktiv 2004/108/EC, 2006/95/EC.
- Danish:** Dette udstyr er i overensstemmelse med de væsentligste krav og andre relevante forordninger i direktiv 2004/108/EC, 2006/95/EC.
- Finnish:** Tämä laite täyttää direktiivien 2004/108/EC, 2006/95/EC oleelliset vaatimukset ja muut asiaankuuluvat määräykset.

FOR USE IN 



WEEE Directive & Product Disposal



At the end of its serviceable life, this product should not be treated as household or general waste. It should be handed over to the applicable collection point for the recycling of electrical and electronic equipment, or returned to the supplier for disposal.

Declaration of Conformity

We, Edimax Technology Co., Ltd., declare under our sole responsibility, that the equipment described below complies with the requirements of the European directive 2004/108/EC and 2006/95/EC.

Equipment: 3Mpx PoE Day & Night PT Network Camera

Model No.: PT-31E

Report No.: T110906220-E, T110906220-LV

The following European standards for essential requirements have been followed:

European Standard: 2004/108/EC

EN 55022:2006+A1:2007

EN 61000-3-2:2006

EN 61000-3-3:2008

EN 55024:1998+A1:2001+A2:2003

IEC 61000-4-2:2008

IEC 61000-4-3:2006+A1:2007

IEC 61000-4-4:2004

IEC 61000-4-5:2005

IEC 61000-4-6:2003+A1:2004+A2:2006

IEC 61000-4-8:2009

IEC 61000-4-11:2004

European Standard: 2006/95/EC

IEC 60950-1:2005(2nd Edition)+Am 1:2009

EN 60950-1:2006+A11:2009+A1:2010

Edimax Technology Co., Ltd.

No. 3, Wu Chuan 3rd Road,

Wu-Ku Industrial Park,

New Taipei City, Taiwan

Date of Signature: September 14, 2011

Signature:

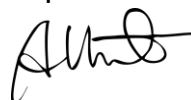

Printed Name:

Albert Chang

Title:

Director

Edimax Technology Co., Ltd.



Declaration of Conformity

We, Edimax Technology Co., Ltd., declare under our sole responsibility, that the equipment described below complies with the requirements of the European R&TTE directive and EMC directive, ETSI.

Equipment: 3Mpx Wireless Day & Night PT Network Camera
Model No.: PT-31W
Report No.: T110919202-RE1

The following European standards for essential requirements have been followed:

| | |
|--|----------------------------|
| ETSI EN 301 489-17 V2.1.1 2009-05 | EN 55022:2006+A1:2007 |
| ETSI EN 301 489-1 V1.8.1 2008-04 | EN 61000-3-2:2006 |
| | +A1:2009 +A2:2009, Class A |
| | EN 61000-3-3:2008 |
| | EN 61000-4-2:2009 |
| | EN 61000-4-3:2006 |
| | +A1:2008 +A2:2010 |
| | EN 61000-4-4:2004 |
| | EN 61000-4-5:2006 |
| | EN 61000-4-6:2009 |
| | EN 61000-4-11:2004 |

Edimax Technology Co., Ltd.
No. 3, Wu Chuan 3rd Road,
Wu-Ku Industrial Park,
New Taipei City, Taiwan

Date of Signature: June 24, 2012

Signature:



Printed Name: Albert Chang

Title: Director

Edimax Technology Co., Ltd.



This product includes software that is subject to the GNU General Public License version 2. The program is free software and distributed without any warranty of the author. We offer, valid for at least three years, to give you, for a charge no more than the costs of physically performing source distribution, a complete machine-readable copy of the corresponding source code.

Das Produkt beinhaltet Software, die den Bedingungen der GNU/GPL-Version 2 unterliegt. Das Programm ist eine sog. „Free Software“, der Autor stellt das Programm ohne irgendeine Gewährleistungen zur Verfügung. Wir bieten Ihnen für einen Zeitraum von drei Jahren an, eine vollständige maschinenlesbare Kopie des Quelltextes der Programme zur Verfügung zu stellen – zu nicht höheren Kosten als denen, die durch den physikalischen Kopiervorgang anfallen.

GNU GENERAL PUBLIC LICENSE

Version 2, June 1991

Copyright (C) 1989, 1991 Free Software Foundation, Inc. 51 Franklin Street, Fifth Floor, Boston, MA 02110-1301, USA
Everyone is permitted to copy and distribute verbatim copies of this license document, but changing it is not allowed.

Preamble

The licenses for most software are designed to take away your freedom to share and change it. By contrast, the GNU General Public License is intended to guarantee your freedom to share and change free software--to make sure the software is free for all its users. This General Public License applies to most of the Free Software Foundation's software and to any other program whose authors commit to using it. (Some other Free Software Foundation software is covered by the GNU Lesser General Public License instead.) You can apply it to your programs, too.

When we speak of free software, we are referring to freedom, not price. Our General Public Licenses are designed to make sure that you have the freedom to distribute copies of free software (and charge for this service if you wish), that you receive source code or can get it if you want it, that you can change the software or use pieces of it in new free programs; and that you know you can do these things.

To protect your rights, we need to make restrictions that forbid anyone to deny you these rights or to ask you to surrender the rights. These restrictions translate to certain responsibilities for you if you distribute copies of the software, or if you modify it.

For example, if you distribute copies of such a program, whether gratis or for a fee, you must give the recipients all the rights that you have. You must make sure that they, too, receive or can get the source code. And you must show them these terms so they know their rights.

We protect your rights with two steps: (1) copyright the software, and (2) offer you this license which gives you legal permission to copy, distribute and/or modify the software.

Also, for each author's protection and ours, we want to make certain that everyone understands that there is no warranty for this free software. If the software is modified by someone else and passed on, we want its recipients to know that what they have is not the original, so that any problems introduced by others will not reflect on the original authors' reputations.

Finally, any free program is threatened constantly by software patents. We wish to avoid the danger that redistributors of a free program will individually obtain patent licenses, in effect making the program proprietary. To prevent this, we have made it clear that any patent must be licensed for everyone's free use or not licensed at all.

The precise terms and conditions for copying, distribution and modification follow.

TERMS AND CONDITIONS FOR COPYING, DISTRIBUTION AND MODIFICATION

0. This License applies to any program or other work which contains a notice placed by the copyright holder saying it may be distributed under the terms of this General Public License. The "Program", below, refers to any such program or work, and a "work based on the Program" means either the Program or any derivative work under copyright law: that is to say, a work containing the Program or a portion of it, either verbatim or with modifications and/or translated into another language. (Hereinafter, translation is included without limitation in the term "modification".) Each licensee is addressed as "you".

Activities other than copying, distribution and modification are not covered by this License; they are outside its scope. The act of running the Program is not restricted, and the output from the Program is covered only if its contents constitute a work based on the Program (independent of having been made by running the Program). Whether that is true depends on what the Program does.

1. You may copy and distribute verbatim copies of the Program's source code as you receive it, in any medium, provided that you conspicuously and appropriately publish on each copy an appropriate copyright notice and disclaimer of warranty; keep intact all the notices that refer to this License and to the absence of any warranty; and give any other recipients of the Program a copy of this License along with the Program.

You may charge a fee for the physical act of transferring a copy, and you may at your option offer warranty protection in exchange for a fee.

2. You may modify your copy or copies of the Program or any portion of it, thus forming a work based on the Program, and copy and distribute such modifications or work under the terms of Section 1 above, provided that you also meet all of these conditions:

- a) You must cause the modified files to carry prominent notices stating that you changed the files and the date of any change.
- b) You must cause any work that you distribute or publish, that in whole or in part contains or is derived from the Program or any part thereof, to be licensed as a whole at no charge to all third parties under the terms of this License.
- c) If the modified program normally reads commands interactively when run, you must cause it, when started running for such interactive use in the most ordinary way, to print or display an announcement including an appropriate copyright notice and a notice that there is no warranty (or else, saying that you provide a warranty) and that users may redistribute the program under these conditions, and telling the user how to view a copy of this License. (Exception: if the Program itself is interactive but does not normally print such an announcement, your work based on the Program is not required to print an announcement.)

These requirements apply to the modified work as a whole. If identifiable sections of that work are not derived from the Program, and can be reasonably considered independent and separate works in themselves, then this License, and its terms, do not apply to those sections when you distribute them as separate works. But when you distribute the same sections as part of a whole which is a work based on the Program, the distribution of the whole must be on the terms of this License, whose permissions for other licensees extend to the entire whole, and thus to each and every part regardless of who wrote it.

Thus, it is not the intent of this section to claim rights or contest your rights to work written entirely by you; rather, the intent is to exercise the right to control the distribution of derivative or collective works based on the Program.

In addition, mere aggregation of another work not based on the Program with the Program (or with a work based on the Program) on a volume of a storage or distribution medium does not bring the other work under the scope of this License.

3. You may copy and distribute the Program (or a work based on it, under Section 2) in object code or executable form under the terms of Sections 1 and 2 above provided that you also do one of the following:

- a) Accompany it with the complete corresponding machine-readable source code, which must be distributed under the terms of Sections 1 and 2 above on a medium customarily used for software interchange; or,
- b) Accompany it with a written offer, valid for at least three years, to give any third party, for a charge no more than your cost of physically performing source distribution, a complete machine-readable copy of the corresponding source code, to be distributed under the terms of Sections 1 and 2 above on a medium customarily used for software interchange; or,
- c) Accompany it with the information you received as to the offer to distribute corresponding source code. (This alternative is allowed only for noncommercial distribution and only if you received the program in object code or executable form with such an offer, in accord with Subsection b above.)

The source code for a work means the preferred form of the work for making modifications to it. For an executable work, complete source code means all the source code for all modules it contains, plus any associated interface definition files, plus the scripts used to control compilation and installation of the executable. However, as a special exception, the source code distributed need not include anything that is normally distributed (in either source or binary form) with the major components (compiler, kernel, and so on) of the operating system on which the executable runs, unless that component itself accompanies the executable.

If distribution of executable or object code is made by offering access to copy from a designated place, then offering equivalent access to copy the source code from the same place counts as distribution of the source code, even though third parties are not compelled to copy the source along with the object code.

4. You may not copy, modify, sublicense, or distribute the Program except as expressly provided under this License. Any attempt otherwise to copy, modify, sublicense or distribute the Program is void, and will automatically terminate your rights under this License. However, parties who have received copies, or rights, from you under this License will not have their licenses terminated so long as such parties remain in full compliance.

5. You are not required to accept this License, since you have not signed it. However, nothing else grants you permission to modify or distribute the Program or its derivative works. These actions are prohibited by law if you do not accept this License. Therefore, by modifying or distributing the Program (or any work based on the Program), you indicate your acceptance of this License to do so, and all its terms and conditions for copying, distributing or modifying the Program or works based on it.

6. Each time you redistribute the Program (or any work based on the Program), the recipient automatically receives a license from the original licensor to copy, distribute or modify the Program subject to these terms and conditions. You may not impose any further restrictions on the recipients' exercise of the rights granted herein. You are not responsible for enforcing compliance by third parties to this License.

7. If, as a consequence of a court judgment or allegation of patent infringement or for any other reason (not limited to patent issues), conditions are imposed on you (whether by court order, agreement or otherwise) that contradict the conditions of this

License, they do not excuse you from the conditions of this License. If you cannot distribute so as to satisfy simultaneously your obligations under this License and any other pertinent obligations, then as a consequence you may not distribute the Program at all. For example, if a patent license would not permit royalty-free redistribution of the Program by all those who receive copies directly or indirectly through you, then the only way you could satisfy both it and this License would be to refrain entirely from distribution of the Program.

If any portion of this section is held invalid or unenforceable under any particular circumstance, the balance of the section is intended to apply and the section as a whole is intended to apply in other circumstances.

It is not the purpose of this section to induce you to infringe any patents or other property right claims or to contest validity of any such claims; this section has the sole purpose of protecting the integrity of the free software distribution system, which is implemented by public license practices. Many people have made generous contributions to the wide range of software distributed through that system in reliance on consistent application of that system; it is up to the author/donor to decide if he or she is willing to distribute software through any other system and a licensee cannot impose that choice.

This section is intended to make thoroughly clear what is believed to be a consequence of the rest of this License.

8. If the distribution and/or use of the Program is restricted in certain countries either by patents or by copyrighted interfaces, the original copyright holder who places the Program under this License may add an explicit geographical distribution limitation excluding those countries, so that distribution is permitted only in or among countries not thus excluded. In such case, this License incorporates the limitation as if written in the body of this License.

9. The Free Software Foundation may publish revised and/or new versions of the General Public License from time to time. Such new versions will be similar in spirit to the present version, but may differ in detail to address new problems or concerns.

Each version is given a distinguishing version number. If the Program specifies a version number of this License which applies to it and "any later version", you have the option of following the terms and conditions either of that version or of any later version published by the Free Software Foundation. If the Program does not specify a version number of this License, you may choose any version ever published by the Free Software Foundation.

10. If you wish to incorporate parts of the Program into other free programs whose distribution conditions are different, write to the author to ask for permission. For software which is copyrighted by the Free Software Foundation, write to the Free Software Foundation; we sometimes make exceptions for this. Our decision will be guided by the two goals of preserving the free status of all derivatives of our free software and of promoting the sharing and reuse of software generally.

NO WARRANTY

11. BECAUSE THE PROGRAM IS LICENSED FREE OF CHARGE, THERE IS NO WARRANTY FOR THE PROGRAM, TO THE EXTENT PERMITTED BY APPLICABLE LAW. EXCEPT WHEN OTHERWISE STATED IN WRITING THE COPYRIGHT HOLDERS AND/OR OTHER PARTIES PROVIDE THE PROGRAM "AS IS" WITHOUT WARRANTY OF ANY KIND, EITHER EXPRESSED OR IMPLIED, INCLUDING, BUT NOT LIMITED TO, THE IMPLIED WARRANTIES OF MERCHANTABILITY AND FITNESS FOR A PARTICULAR PURPOSE. THE ENTIRE RISK AS TO THE QUALITY AND PERFORMANCE OF THE PROGRAM IS WITH YOU. SHOULD THE PROGRAM PROVE DEFECTIVE, YOU ASSUME THE COST OF ALL NECESSARY SERVICING, REPAIR OR CORRECTION.

12. IN NO EVENT UNLESS REQUIRED BY APPLICABLE LAW OR AGREED TO IN WRITING WILL ANY COPYRIGHT HOLDER, OR ANY OTHER PARTY WHO MAY MODIFY AND/OR REDISTRIBUTE THE PROGRAM AS PERMITTED ABOVE, BE LIABLE TO YOU FOR DAMAGES, INCLUDING ANY GENERAL, SPECIAL, INCIDENTAL OR CONSEQUENTIAL DAMAGES ARISING OUT OF THE USE OR INABILITY TO USE THE PROGRAM (INCLUDING BUT NOT LIMITED TO LOSS OF DATA OR DATA BEING RENDERED INACCURATE OR LOSSES SUSTAINED BY YOU OR THIRD PARTIES OR A FAILURE OF THE PROGRAM TO OPERATE WITH ANY OTHER PROGRAMS), EVEN IF SUCH HOLDER OR OTHER PARTY HAS BEEN ADVISED OF THE POSSIBILITY OF SUCH DAMAGES.



www.edimax.com

Edimax Technology Co., Ltd.
No.3, Wu-Chuan 3rd Road, Wu-Gu,
New Taipei City 24891, Taiwan

Edimax Technology Europe B.V.
Nijverheidsweg 25 5683 CJ Best
The Netherlands

Edimax Computer Company
3350 Scott Blvd., Bldg.15 Santa Clara,
CA 95054, USA

Free Manuals Download Website

<http://myh66.com>

<http://usermanuals.us>

<http://www.somanuals.com>

<http://www.4manuals.cc>

<http://www.manual-lib.com>

<http://www.404manual.com>

<http://www.luxmanual.com>

<http://aubethermostatmanual.com>

Golf course search by state

<http://golfingnear.com>

Email search by domain

<http://emailbydomain.com>

Auto manuals search

<http://auto.somanuals.com>

TV manuals search

<http://tv.somanuals.com>