

eureka![®]

Invented for the way you clean™

430 Series

OWNER'S GUIDE

Guía del Dueño

Le Guide du Propriétaire



Upright Vacuum Cleaner
Household Type
Aspiradora Vertical
Tipo domestico
Aspirateur vertical
de type résidentiel

Thank you for purchasing your new Eureka Vacuum!
¡Gracias por la compra de su nueva aspiradora Eureka!
Merci d'avoir acheté votre nouvel aspirateur Eureka!

**Before Returning, Call
Eureka Customer Service**

Antes de enviar de regreso, llame al Servicio al Cliente de Eureka
Avant de le retourner, appelez le service à la clientèle Eureka

HELPLINE LÍNEA DE AYUDA LIGNE D'AIDE

1-800-282-2886



8 a.m. to 7:30 p.m. (CST), Monday - Friday
10 a.m. to 6:30 p.m. (CST), Saturday - Sunday
8 a.m. a 7:30 p.m. (CST), de Lunes a Viernes
10 a.m. a 6:30 p.m. (CST), Sábado y Domingo
8 h à 19 h 30 (CST), lundi au vendredi
10 h à 18 h 30 (CST), samedi et dimanche

www.eureka.com

Where to Find Important Vacuum Information

Keep this information

Write the model, type and serial number here:

Date of purchase (keep your receipt) _____

Model number and type _____

Serial number _____

Find these numbers on a label on the side of the vacuum cleaner. Refer to these numbers when ordering parts and accessories or if service is needed.

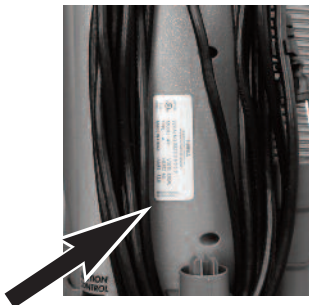

Before You Start Your Vacuum Cleaner

Refer to **Quick Start Guide** for assembly and use. This **Owner's Guide** provides important instructions to prolong the life of your Eureka vacuum cleaner.

Inspection

Carefully unpack and inspect your new Eureka vacuum cleaner for shipping damage. Each unit is tested and thoroughly inspected before shipping. For instructions regarding any shipping damage, call Eureka Customer Service **HELPLINE 1-800-282-2886** immediately.

Table of Contents

Important Safeguards	1
How to Identify Parts of Vacuum Cleaner	2
Maintenance Schedule	2
Dust cup and filter.	
How to Use Accessories	3
Crevice wand, dusting brush, Power Paw® and stair hose.	
How to Maintain Your Vacuum Cleaner	4
Clean brush roll, 'check brush roll' light, how to clear a blockage.	
Eureka Limited Warranty Information	5
Thermal Cut-Off and Problem Solving	6
Spanish Owner's Guide	7-13
French Owner's Guide	14-20
Order Forms and Parts List	21-22



Follow caution information wherever you see this symbol.

IMPORTANT SAFEGUARDS

When using an electrical appliance, basic precautions should always be followed, including the following:

READ ALL INSTRUCTIONS BEFORE USING THIS VACUUM CLEANER WARNING

To reduce the risk of fire, electric shock, or injury:



- Do not use outdoors or on wet surfaces.
- **Do not leave vacuum cleaner when plugged in.** Turn off the switch and unplug the electrical cord when not in use and before servicing.
- Do not allow to be used as a toy. Close attention is necessary when used by or near children.
- Use only as described in this manual. Use only manufacturer's recommended attachments.
- Do not use with damaged cord or plug. If vacuum cleaner is not working as it should, has been dropped, damaged, left outdoors, or dropped into water, return it to a service center before using.
- Do not pull or carry by cord. Do not use cord as a handle. Do not close a door on cord or pull cord around sharp edges or corners. Do not run vacuum cleaner over cord. Keep cord away from heated surfaces.
- Do not use extension cords or outlets with inadequate current carrying capacity.
- Turn off all controls before unplugging.
- Do not unplug by pulling on cord. To unplug, grasp the plug, not the cord.
- Do not handle plug or vacuum cleaner with wet hands.
- Do not put any object into openings. Do not use with any opening blocked; keep free of dust, lint, hair, and anything that may reduce airflow.
- This vacuum cleaner creates suction and contains a revolving brush roll. Keep hair, loose clothing, fingers, and all parts of body away from openings and moving parts.
- Do not place vacuum cleaner on furniture or stairs as the brush roll may cause damage. Use extra care when cleaning stairs. Place vacuum cleaner on floor with the handle in storage position while using attachments.
- Do not pick up anything that is burning or smoking, such as cigarettes, matches, or hot ashes.
- Do not use without dust cup and filter in place.
- Belt pulleys can become hot during normal use. To prevent burns, avoid touching the belt pulley when servicing the drive belt.
- Do not use to pick up flammable or combustible liquids such as gasoline, or use in areas where they may be present.
- Store your vacuum cleaner indoors in a cool, dry area.
- Keep your work area well lighted.
- Unplug electrical appliances before vacuuming them.
- Unplug before connecting Turbo Nozzle.

SAVE THESE INSTRUCTIONS

To reduce the risk of electric shock, this appliance has a polarized plug (one blade is wider than the other). This plug will fit in a polarized outlet only one way. If the plug does not fit fully into the outlet, reverse the plug. If it still does not fit, contact a qualified electrician to install the proper outlet. Do not change the plug in any way.



Motor

Do Not Oil the motor or the brush roll at any time. The bearings are permanently lubricated and sealed.

How to Identify Parts of Vacuum Cleaner

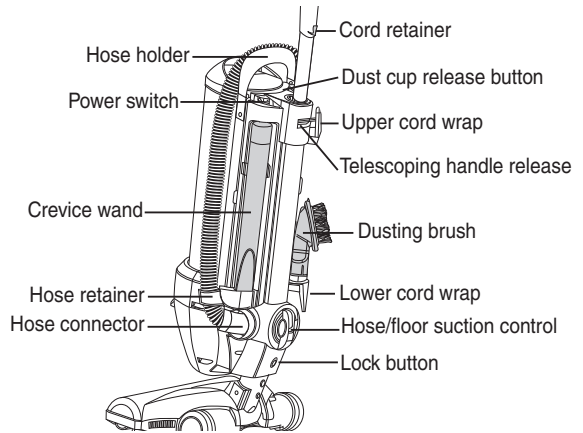
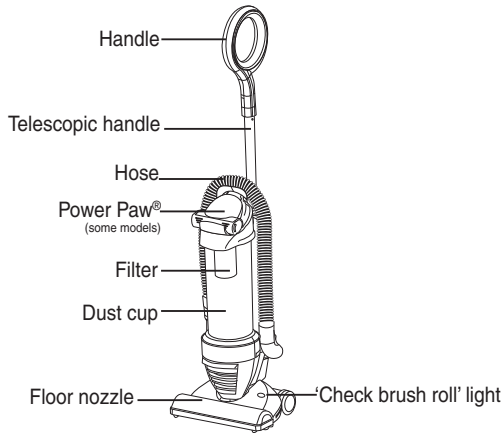

Maintenance Schedule

Maintenance Schedule is also located on back side of dust cup.

 READ ALL INSTRUCTIONS BEFORE USING THIS VACUUM CLEANER. Moving parts! Make sure power switch is in OFF (O) position before plugging in power cord.

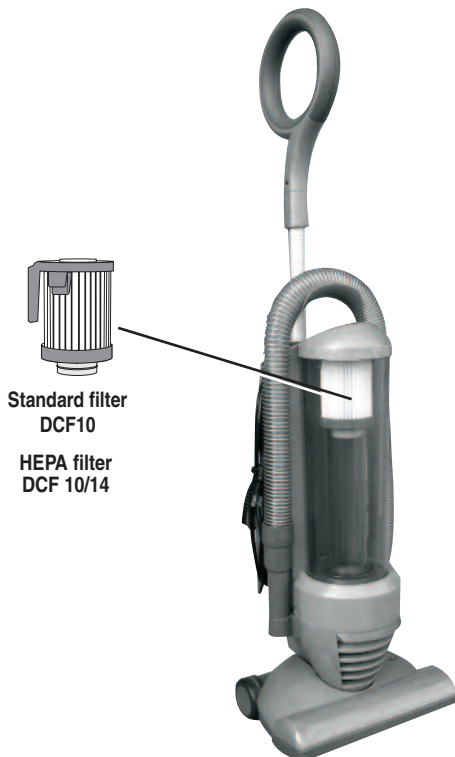

DUST CUP – Empty after each use

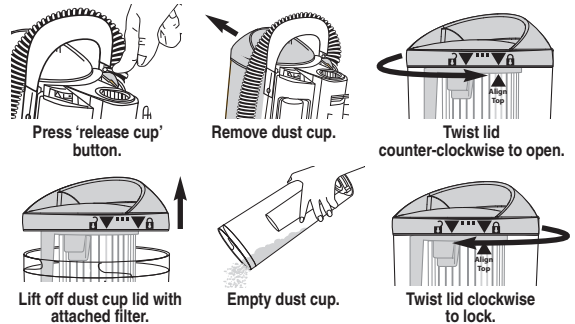

FILTER – Check regularly; clean as needed



REPLACE FILTER – Replace within 3 - 6 months

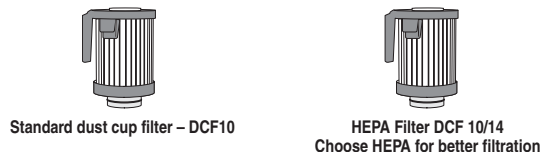



How to Use Accessories

Handle must be in upright position.

Replace hose end into hose retainer after using accessories.



When Using Accessories

Turn hose/floor suction control to 'HOSE'.
Press power switch to (I), suction only.

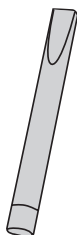

Crevice Wand

Use for baseboards and corners.
Push crevice wand onto end of hose.

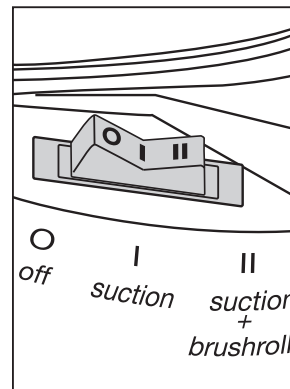
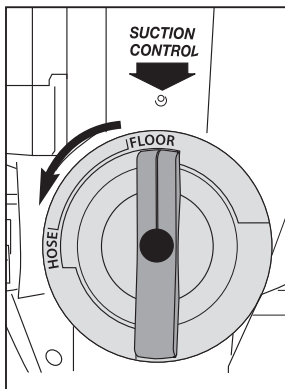

Dusting Brush

Use for furniture, drapes and vents.
Place dusting brush on end of hose or crevice wand.

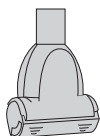
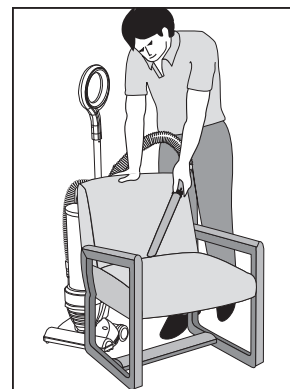
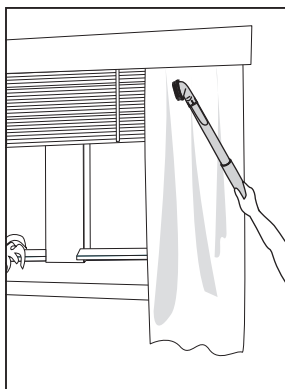

Power Paw®

(with some models or available for purchase)

Stair Hose (available for purchase)

Use for furniture and stairs.

Make sure vacuum is below you, pushed against the bottom step.

- 1) If model has additional stair hose, attach to end of hose.
- 2) Attach Power Paw to the end of hose.

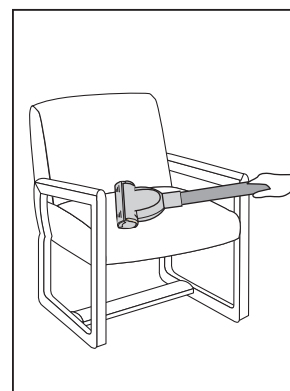



How to Maintain Your Vacuum Cleaner

Make sure vacuum cleaner is turned off and power cord is unplugged

Clean Brush Roll

Turn vacuum face down on floor. Use scissors to remove hair and threads from brush roll. (Fig. 1).

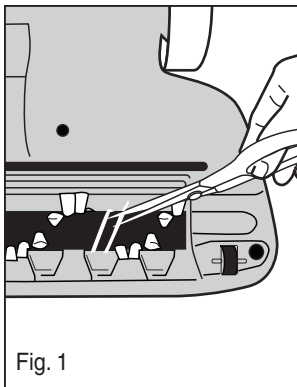

Fig. 1

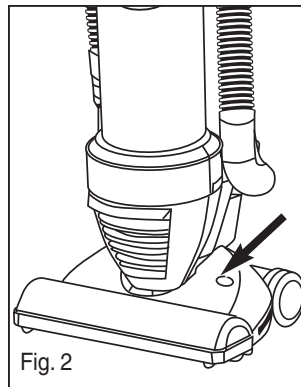

Fig. 2



'Check Brush Roll' Light

Turn vacuum off and unplug if indicator light turns on. Remove debris that caused the brush roll motor to stall (Fig. 2).

How to Clear a Blockage

Hose Blockage

Remove hose end from hose retainer. Flexing the hose will loosen any blockage (Fig. 3).

Twist hose connector tab clockwise to remove hose from vacuum body. Clear blockage from hose inlet (Fig. 4).

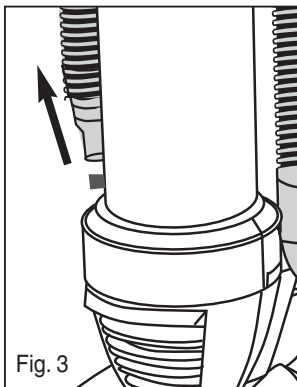

Fig. 3

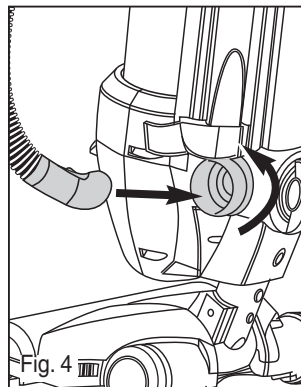

Fig. 4

Blockage in Vacuum Base

Turn vacuum face down on floor.

Squeeze latch to remove cover from clean-out port. (Fig. 5).

Use finger to locate and remove clog from base.

If still clogged, push in lock button and pull floor nozzle off vacuum body. Remove clog from neck of floor nozzle (Fig. 6).

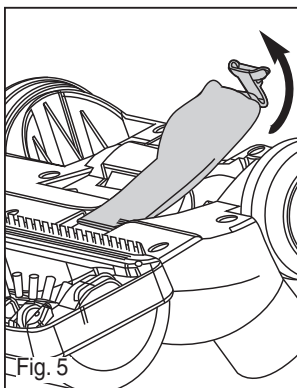

Fig. 5

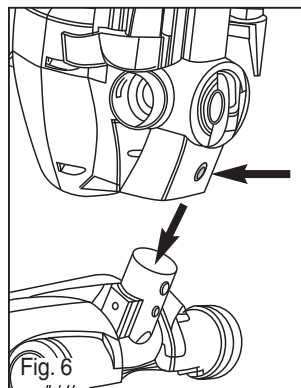

Fig. 6

The Eureka Limited Warranty

Eureka warrants this vacuum cleaner to be free from defects in material and workmanship for a term of one year for normal household use. Warranty is granted only to the original purchaser and members of immediate household.

This warranty is good for one year from the date of purchase only when the vacuum cleaner is used in the accordance with Eureka operating instructions.

This Warranty Does Not Cover

- Parts of the vacuum that require replacement under normal use such as disposable dust bags, filters, drive belts, light bulbs, brush roll, bristles, impellers and cleaning.
- Damages or malfunctions caused by negligence, abuse, and use not in accordance with the Owner's Guide.
- Defects or damages caused by unauthorized service or the use of other than Genuine Eureka, ARM & HAMMER™ and Filtrete™ by 3M parts.

What Eureka Will Do

Eureka will, at its option, repair or replace a defective vacuum or vacuum part that is covered by this warranty. As a matter of warranty policy, **Eureka will not refund the consumer's purchase price.**

Warranty Registration

Please fill out and return the warranty registration card accompanying your vacuum.

Obtaining Warranty Service

To obtain warranty service you must return the vacuum or vacuum part along with "proof of purchase" to any Eureka Authorized Warranty Station. For Eureka Authorized Warranty Station or Service Information, visit **www.eureka.com**, write or telephone toll free:

USA: 1-800-282-2886
Electrolux Home Care
North America Service Division
P.O. Box 3900
Peoria, IL 61612

Mexico: (55) 5343-384
Electrolux Home Care

Canada: 1-800-282-2886
Electrolux Home Care
North America Service Division
5855 Terry Fox Way
Mississauga, Ontario L5V 3E4

Obtaining Warranty Service Outside Your Community

You must pay the shipping charges to the Eureka Authorized Warranty Station.

Return Shipping Charges will be paid by the Warranty Station. When returning parts for repair, please include the model, type and serial number located on the rating plate on the lower backside of the vacuum.

Further Limitations and Exclusions

Any warranty that may be implied in connection with your purchase or use of the vacuum, including any warranty of Merchantability or any warranty for Fitness For A Particular Purpose is limited to the duration of this warranty. Some states do not allow limitations on how long an implied warranty lasts, so the above limitations may not apply to you.

Your relief for the breach of this warranty is limited to the relief expressly provided above. In no event shall the manufacturer be liable for any consequential or incidental damages you may incur in connection with your purchase or use of the vacuum.

Some states do not allow the exclusion or limitation of incidental or consequential damages, so the above limitation or exclusion may not apply to you.

This warranty gives you specific legal rights. You may also have other rights, which may vary by state.

The ARM & HAMMER name is a trademark of Church and Dwight Co., Inc. 3M and Filtrete are trademarks of 3M Company, used by Electrolux Home Care Products, Inc. under license.

Thermal Cut-Off

This vacuum cleaner has a special thermostat that protects the vacuum in case of motor overheating. If the vacuum suddenly shuts off, push the power switch to off (O) and unplug the vacuum. Check the vacuum for a possible source of overheating such as a full dust cup, blocked hose or clogged filter. If these conditions are found, fix them and wait at least 30 minutes before attempting to use the vacuum. After the 30 minute period, plug the vacuum back in and turn on the switch. If the vacuum still does not work, take it to a Eureka authorized service center for repair or call 1-800-282-2886.

Problem Solving



Make sure vacuum is turned off and power cord is unplugged.

Problem	Cause	Solution
Motor will not start.	Power switch	<ul style="list-style-type: none"> • Turn power switch to (I) suction for bare floor or accessories. • Turn power switch to (II) suction + brush roll for carpet.
Vacuum does not clean carpet or bare floor.	Dust cup and filter	<ul style="list-style-type: none"> • Empty dust cup, clean and/or change filter. • If picking up fine dust, the dust cup may not look full, but a fine substance tends to reduce suction when it blocks air flow through the filter. Refer to page 2 for filter maintenance. Make sure filter and dust cup are installed properly.
	Hose	<ul style="list-style-type: none"> • Remove clogs from the hose that restrict the airflow. Page 4 • Clear blockage from hose inlet. Page 4 • Make sure suction control knob is turned to 'FLOOR' setting. Page 3 • Make sure hose connector is replaced into side of vacuum body. Page 4
Brush roll indicator light comes on.	Brush roll stalled	<ul style="list-style-type: none"> • Check brush roll for debris. Page 4
No suction at the end of hose.	Dust cup and filter	<ul style="list-style-type: none"> • Empty dust cup, clean and/or change filter. • If picking up fine dust, the dust cup may not look full, but a fine substance tends to reduce suction when it blocks air flow through the filter. Refer to page 2 for filter maintenance. Make sure filter and dust cup are installed properly.
	Hose	<ul style="list-style-type: none"> • Remove clogs from the hose that restrict the airflow. Page 4 • Clear blockage from hose inlet. Page 4 • Make sure suction control knob is turned to 'HOSE' setting. Page 3 • Make sure hose connector is replaced into side of vacuum body. Page 4

Free Manuals Download Website

<http://myh66.com>

<http://usermanuals.us>

<http://www.somanuals.com>

<http://www.4manuals.cc>

<http://www.manual-lib.com>

<http://www.404manual.com>

<http://www.luxmanual.com>

<http://aubethermostatmanual.com>

Golf course search by state

<http://golfingnear.com>

Email search by domain

<http://emailbydomain.com>

Auto manuals search

<http://auto.somanuals.com>

TV manuals search

<http://tv.somanuals.com>