

Speed Dome

EPTZ2700/EPTZ2700I

USER MANUAL

Date: Oct. 2008

Table of Contents

1. EPTZ2700/EPTZ2700I OVERVIEW	5
1.1. Introduction	5
1.2. Specifications	7
1.3. Feature	9
1.3.1. Profile of EPTZ2700/EPTZ2700I	9
1.3.2. EPTZ2700/EPTZ2700I Base Board	10
1.4. EPTZ2700/EPTZ2700I Quick Operation Guide (Work with EKB500)	12
2. EPTZ2700/EPTZ2700I INSTALLATION	13
2.1. Packing List	13
2.2. Cable Needed.....	14
2.3. Initial Setup	15
2.3.1. Address Setting	15
2.3.2. Communication Protocol Setting	19
2.3.3. Transmission Speed Setting (Baud Rate Setting)	19
2.4. Bracket and Speed Dome Installation	20
2.4.1. Installation Requirements	20
2.4.2. EPTZ2700 Dome Camera Installation	21
2.5. Accessories	30
2.5.1. EPTZ-CPMA: Ceiling Pendant Mount Adapter	30
2.5.2. EPTZ-PMA: Pole Mount Adapter	30
2.5.3. EPTZ- CMA: Corner Mount Adapter	31
3. EPTZ2700/EPTZ2700I CAMERA SETUP MENU.....	32
3.1. Structure of the Setup Menu	32
3.2. VIDEO SETTINGS	33

3.2.1.	EXPOSURE	33
3.2.2.	FOCUS MODE.....	35
3.2.3.	DIGITAL ZOOM.....	35
3.2.4.	WHITE BALANCE	35
3.2.5.	BACKLIGHT	36
3.2.6.	DAY/NIGHT	36
3.2.7.	COLOR	37
3.2.8.	NEGATIVE	37
3.2.9.	WIDE DYNAMIC RANGE.....	37
3.2.10	EXIT	37
3.3.	POSITIONS.....	38
3.4.	OSD/AREAS	41
3.4.1.	CAM. TITLE.....	41
3.4.2.	AREAS	41
3.4.3.	DIRECTIONS	43
3.4.4.	DISPLAY	45
3.4.5.	EXIT	46
3.5.	AUTO MODES	47
3.5.1.	AUTOPAN	47
3.5.2.	PRESET TOURS	49
3.5.3.	PATTERN	51
3.5.4.	AUTO RESUME	52
3.5.5.	RESUME TO	52
3.5.6.	POWER UP FUNC.....	53
3.5.7.	AUTO FLIP.....	53
3.5.8.	EXIT	53

3.6.	ALARM	53
3.6.1.	ALARM INPUTS.....	53
3.6.2.	ALARM OUTPUTS.....	56
3.6.3.	EXIT	57
3.7.	SYSTEM.....	58
3.8.	INFO.....	59
3.9.	EXIT	60
4.	EPTZ2700/2700I FUNCTION SETUP AND OPERATION.....	61
4.1.	Manual Control Mode.....	61
4.2.	Auto Pan Mode	61
4.3.	Position Setting	62
4.4.	Tour Mode	63
4.5.	Alarm Link to a Position/Tour.....	64
4.6.	Other Operations.....	65

1. EPTZ2700/EPTZ2700I OVERVIEW

1.1. Introduction

EPTZ2700 series has 2 types, EPTZ2700 is outdoor type whereas EPTZ2700I is indoor type, using high sensitivity and high resolution CCD to display high quality image. The design of ICR (IR cut filter removable) can provide real color even under strong sunlight in day time. Under slight light in night time, a clear image can still be displayed. WDR design allows the camera to be installed in any environment. Fast moving function can reach to 360°/1sec. No matter high speed scanning or low speed scanning, the solid base can avoid vibration. This full-functioned speed dome can perform best quality images!

- EPTZ2700 for outdoor model; EPTZ2700I for indoor model
- Built in 27X Optical Zoom Lens
- Super High Resolution more than 480TV Lines
- True Day and Night function (IR Cut Filter Removable)
- Wide Dynamic Range
- Digital Slow Shutter
- Auto detection of protocols
- Tilt rotation range -180°
- 192 preset positions are available
- 16 cruise tours can be set, and each tour contains up to 16 positions
- 4 Alarm Inputs / 2 Alarm Outputs
- Running to position speed, 0.01°/s to 360°/s
- RS485 Communication
- IP 66 (for EPTZ2700)

Furthermore, the micro control unit enables camera a nimble and exact movement from minimal 0.01°/sec to maximal 360°/sec. It can go to every preset position in 1 second. It also has other advantages such as:

- 192 preset positions are available.
- 16 cruise tours can be set, and each tour contains up to 16 positions.
- Up to 256 speed domes can be supported on a RS-485 bus when all speed domes are controlled by keyboard EKB500.
- Built-in fan to enhance heat dissipation at high temperature and circulate heat to keep system operation at low temperature.
- Built-in 4 alarm inputs and 2 alarm outputs.

All of the features make the intelligent high-speed dome camera works for a wide range and demanding application such as banks, airports, stations, casinos, streets of cities, intelligent buildings, etc.

1.2. Specifications

Product Model	EPTZ2700 (outdoor)	EPTZ2700I (indoor)
Pickup Device	1/4" CCD	
Video Format	NTSC or PAL	
Scanning System	NTSC: 525 TV lines, 60 fields/sec PAL: 625 TV lines, 50 fields/sec.	
Picture Elements	768 x 494 (NTSC) 752 x 582 (PAL)	
Horizontal Resolution	More than 480 TV Lines	
Sensitivity	1 Lux/ F1.5 (Normal) 0.01 Lux/ F1.5 (ICR OFF, DSS16X) 0 Lux/ F1.5 (ICR ON, DSS16X)	
S/N Ratio	48 dB	
Electronic Shutter	1/50 ~ 1/10,000(s) (NTSC)	
Digital Slow Shutter	Auto: 2x, 4x, 6x, 10x, 16x, 32x Fix: 2x, 4x, 6x, 10x, 16x, 32x	
Shutter Selection	AUTO; A.FLK; Manual (1/50~1/10000) selectable	
Lens Type	27x optical zoom, f=3.25 mm (wide) to 88.0 mm (tele), F1.5 to F3.8	
Zoom Ratio	270x max (27x Optical and x 10 Digital zoom)	
True Day & Night	Yes (Auto/DAY/NIGHT)	
Backlight Comp.	Yes (OFF/ON)	
Wide Dynamic Range	Yes (OFF/ON/AUTO)	
White Balance	Auto / Indoor / Outdoor	
Motion Detection	Yes (OFF/ON)	
Private Zone Masking	No	
Video Output	1Vp-p / 75 ohm	
Sync. Mode	Internal	
Power Source	24VAC	
Power Consumption	21W Max	
Operating Temperature	- 40°C ~ +50°C ≤95%	-10°C ~ +50°C ≤85%
Focus Control	One push/Auto/Manual	
Horizontal Rotation Speed	0.01°/s – 360°/s (1-255 grade shift gears)	

Horizontal Rotation Range	360° unlimited rotation
Tilt Rotation Range	90° pendulum motion
Auto Zoom Speed Control	Control speed auto-adjusted according to zoom length changing
Auto Pan, 2 points scanning	Can set freely
Auto Pan Speed	1 – 255 grade available
Dwell Time (2 points)	1 – 99 second available
Preset Positions	192 positions
Running to position speed	1 – 255 grade available, 0.01°/s - 360°/s
Dwell time at preset position	1 – 99 available
Tour	16 groups
Tour point per group	16 preset positions
Pattern	4 patterns with 90 sec long each
Fan	Fan auto starts
Position Accuracy	±0.1°
Alarm	4 in 2 out with tour/position auto triggering
Built-in Menu for Functions	Yes
Communication	RS-485
Communication Speed	1200/2400/4800/9600bps
Built-in Protocols	EVF-1; EVF-2; Pelco-P ;Pelco-D; A-Type; Plus-D; AUTO; Panasonic (Plus-D supports all other brands, it is equivalent to Pelco-D)
Address Editable	Yes (through DIP switch)
Speed Dome Address	0-255
Manual Pan/Tilt Speed	Pan: 0.01° ~ 360°/s ; Tilt: 0.01° ~ 180°/s
Safety	CE, FCC
Dimensions	180mm(W) x 270mm(H) ; 70.9"x106.3"
Weight	3.0kg

1.3. Feature

1.3.1. Profile of EPTZ2700/EPTZ2700I

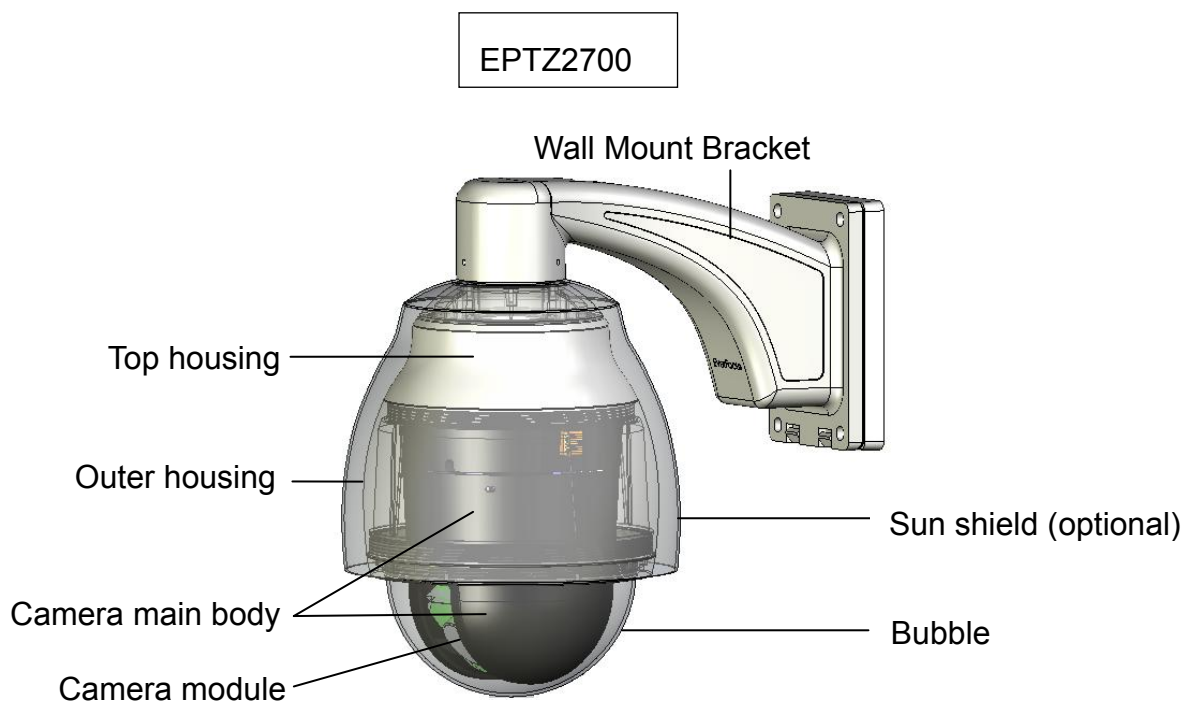

Pin #	Function
1	ALM_NO_B (Alarm Output Normal Open B)
2	ALM_COM_B (Alarm Output Common B)
3	ALM_NC_B (Alarm Output Normal Close B)
4	ALM_NO_A (Alarm Output Normal Open A)
5	ALM_COM_A (Alarm Output Common A)
6	ALM_NC_A (Alarm Output Normal Close A)
7	ALMIN1 (Alarm Input 1)
8	GND (Ground)
9	ALMIN2 (Alarm Input 2)
10	ALMIN3 (Alarm Input 3)
11	GND (Ground)
12	ALMIN4 (Alarm Input 4)
13	VIDEO+
14	VIDEO-
15	RS485-
16	RS485+
17	AC24A+
18	AC24B-

1.4. EPTZ2700/EPTZ2700I Quick Operation Guide (Work with EKB500)

EPTZ2700/EPTZ2700I and EKB500 (Keyboard) can work together by using factory default setting. You just need to connect cables by the following steps:

1. Connect the RS-485 cable to EPTZ2700/EPTZ2700I and a keyboard (EKB500).
2. Connect a video cable from EPTZ2700/EPTZ2700I to a monitor.
3. Connect the power to the EPTZ2700/EPTZ2700I and a keyboard (EKB500).

After the EPTZ2700/EPTZ2700I finishes the self-test mode, you can start to operate the EPTZ2700/EPTZ2700I via the keyboard.

To operate the EPTZ2700/EPTZ2700I:

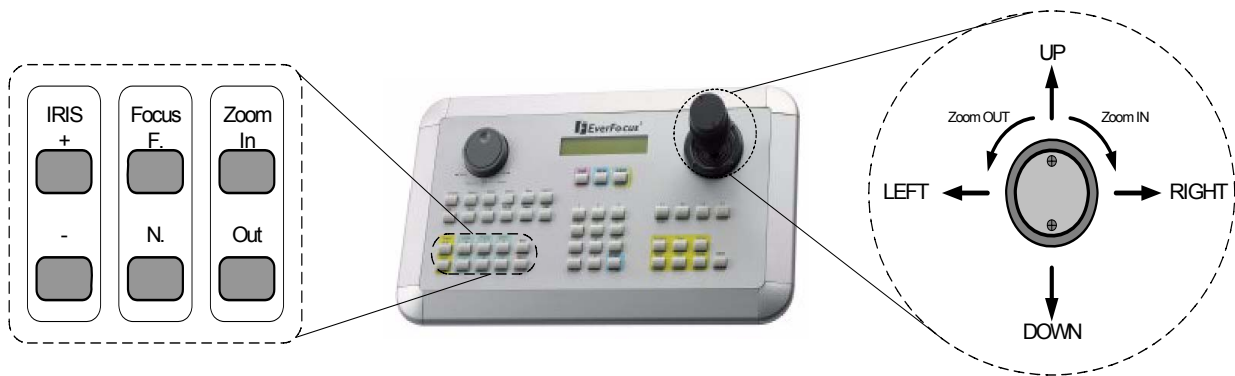

1. Shift the Joystick up/down or right/left to view from camera.
2. Turn the top of the Joystick to zoom in/out.
3. Press Zoom In/Out, Focus F./N. and IRIS +/- function keys to operate the EPTZ2700/EPTZ2700I.

2. EPTZ2700/EPTZ2700I INSTALLATION

2.1. Packing List

There are 3 boxes that are camera main body with a camera module, top housing with a base board & pin connector and outer housing with bubble, plus one tool packet in the package. The detail accessories are listed below:

Standard

- Camera Main Body x 1
- Top Housing x1
- Outer Housing with Bubble x1
- Tool packet
 - ✧ Glove x 1 pair
 - ✧ 3 desiccant packs

Optional Accessories

* EPTZ-PBOX
(External Power Connection Box)



* Pole Mount Adapter



* EKB500 (Keyboard)



* Wall Mount Bracket



* Corner Mount Adapter



* Ceiling Pendant Mount Bracket



* Indoor Recessed Mount Bracket



* Concrete Ceiling Mount Adapter



2.2. Cable Needed

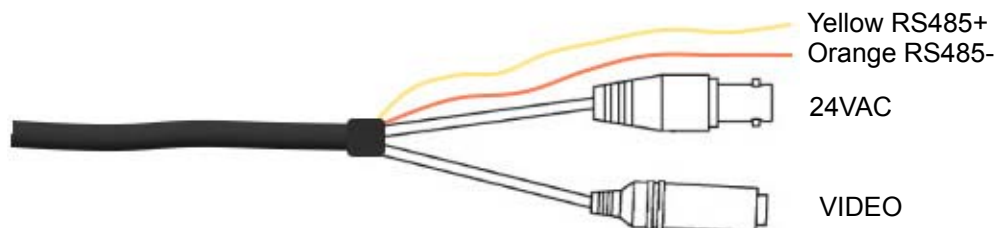

Power Cable

An adapter with 24VAC/3.5A output provides the power to the EPTZ2700/EPTZ2700I. An extension power line may be needed.

Note: The input AC voltage range of an adapter depends on different area.

Please make sure the voltage range before installing.

Video Cable

A BNC cable is used for connecting an EPTZ2700/EPTZ2700I to a DVR or a monitor. An amplifier may be needed if the video cable is too long.

RS485 Cable

Yellow wire represents RS485+, orange wire represents RS485-. Connect RS485 to EKB500 and you will be able to control the speed dome by a keyboard. If you are unable to control the speed dome with EKB500, it is probably due to a mis-connection. Please try to switch RS485 wires and connect again.

2.3. Initial Setup

Initial setup includes dome address, communication protocol, transmission speed, and terminal resistance settings. All of the settings should be confirmed before the dome is installed. The control-related setting that is address, communication protocol and transmission speed have to be set consistently with the control device such as a keyboard or a DVR.

Notice: Please make sure the power is off before setting, and restart the EPTZ2700/EPTZ2700I to enable a new value after changing.

2.3.1. Address Setting

The address code of the EPTZ2700/EPTZ2700I should be set to correspond properly with a control device to control multiple dome cameras. The address codes are made up by the dipswitch on the camera main body. The 8 bits dipswitch indicates the binary coded of the address, and there are 256 addresses can be selected (0 ~ 255). It also means that there are up to 256 dome cameras that can cascade on the RS-485 bus. The dipswitch setting and the indicated address are represented in the following diagram.





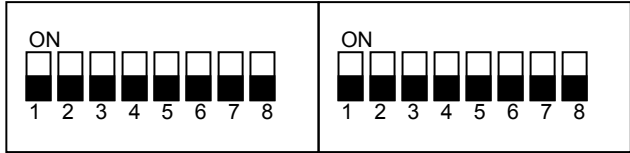
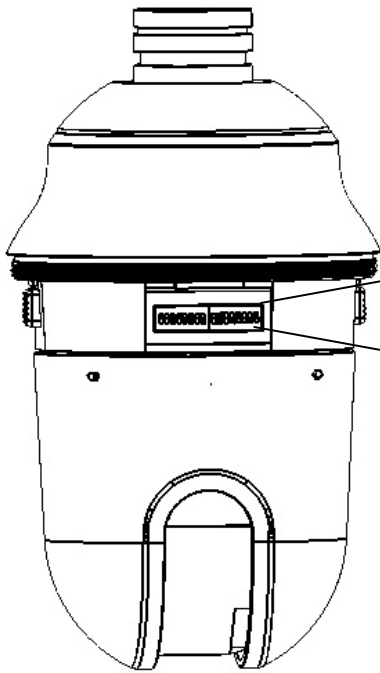































































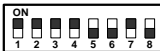
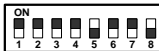







































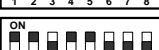
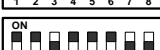







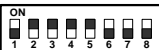
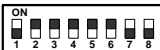
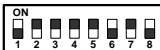
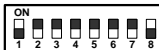
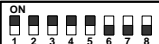
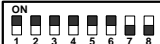

Note: The factory default address is 1.

Notice: Please make sure the power is off before setting, and restart the EPTZ2700/EPTZ2700I to enable a new value after changing.



Protocol/Baud rate/ Terminal resistance

ID address

Switch	Address	Switch	Address	Switch	Address	Switch	Address
	0		32		64		96
	1		33		65		97
	2		34		66		98
	3		35		67		99
	4		36		68		100
	5		37		69		101
	6		38		70		102
	7		39		71		103
	8		40		72		104
	9		41		73		105
	10		42		74		106
	11		43		75		107
	12		44		76		108
	13		45		77		109
	14		46		78		110
	15		47		79		111
	16		48		80		112
	17		49		81		113
	18		50		82		114
	19		51		83		115
	20		52		84		116
	21		53		85		117
	22		54		86		118
	23		55		87		119
	24		56		88		120
	25		57		89		121
	26		58		90		122
	27		59		91		123
	28		60		92		124
	29		61		93		125
	30		62		94		126
	31		63		95		127

Switch	Address	Switch	Address	Switch	Address	Switch	Address
	128		160		192		224
	129		161		193		225
	130		162		194		226
	131		163		195		227
	132		164		196		228
	133		165		197		229
	134		166		198		230
	135		167		199		231
	136		168		200		232
	137		169		201		233
	138		170		202		234
	139		171		203		235
	140		172		204		236
	141		173		205		237
	142		174		206		238
	143		175		207		239
	144		176		208		240
	145		177		209		241
	146		178		210		242
	147		179		211		243
	148		180		212		244
	149		181		213		245
	150		182		214		246
	151		183		215		247
	152		184		216		248
	153		185		217		249
	154		186		218		250
	155		187		219		251
	156		188		220		252
	157		189		221		253
	158		190		222		254
	159		191		223		255

2.3.2. Communication Protocol Setting

The 1st, 2nd and 3rd bits are used to set communication protocol. The factory default protocol is EVF.

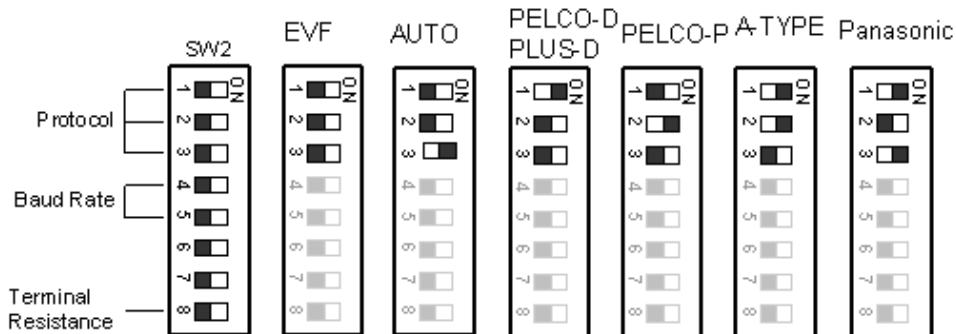

Notice: Please make sure the power is off before setting, and restart the EPTZ2700/EPTZ2700I to enable a new value after changing.

Set all of protocol switches to ON; the speed dome EPTZ2700/EPTZ2700I will enter a self-test mode.

2.3.3. Transmission Speed Setting (Baud Rate Setting)

The 4th and 5th bits on the PCB board are used to set the Baud Rate. The default baud rate setting is 9600.

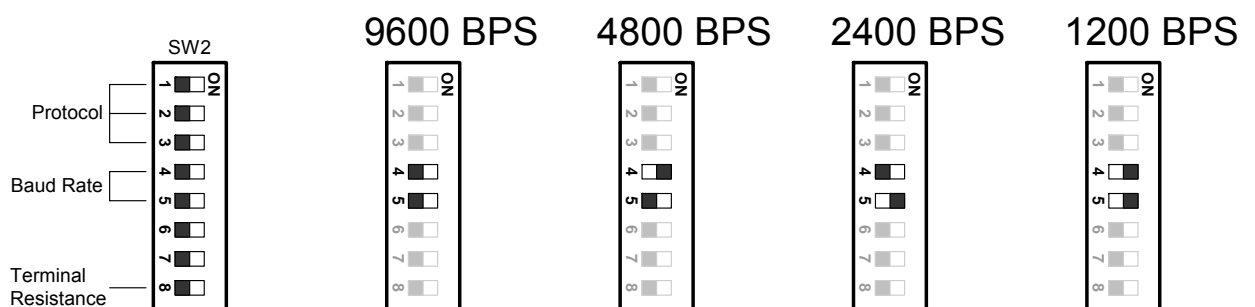

Notice: Please make sure the power is off before setting, and restart the EPTZ2700/EPTZ2700I to enable a new value after changing.

2.4. Bracket and Speed Dome Installation

2.4.1. Installation Requirements

1. Installation should be handled by a qualified service agent and should comply with all local regulations. Service personnel should expect potential problems such as surface strength, surface material, falling objects, outer breaches, building vibration or other similar conditions.
2. Check for all necessary materials, and ensure if the selected installation location is suitable for the EPTZ2700/EPTZ2700I.

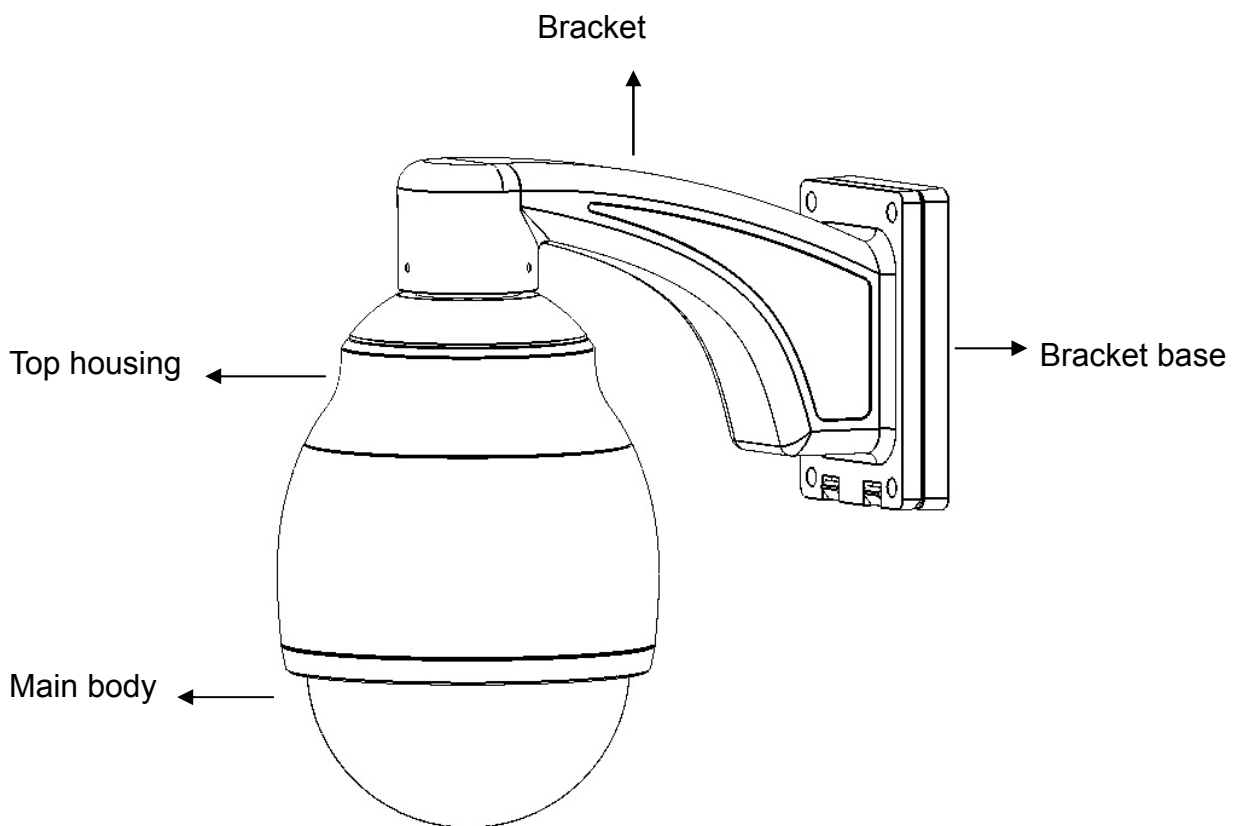

ETPZ2700 overview

2. Apply the adhesive stripe at back of desiccant pack to the inner side of the top housing. There are totally 3 desiccant packs to be applied.



3. When all the desiccant packs are pasted and alarm cables are connected properly, put the base board back to its original place, you will need to pull open the switch in order to have the base board fitted to the top housing.

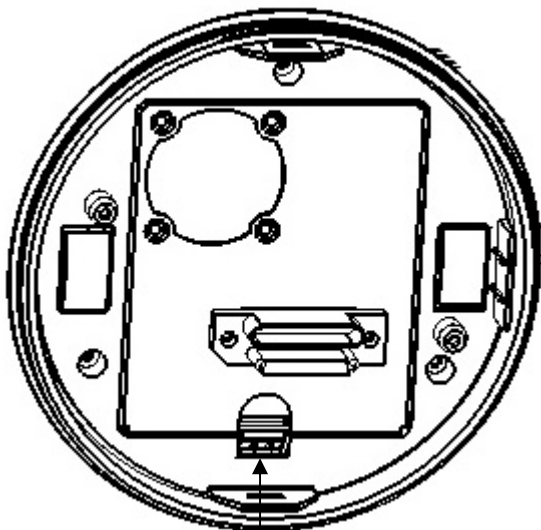

Pull open this switch

4. Connect the cable you detached from base board to the RS485 cable, Power cable and video cable you tread from the wall or ceiling. RS485 cable has to be connected via a terminal block. If you need to connect alarm cable, thread the alarm cable through the second hole.

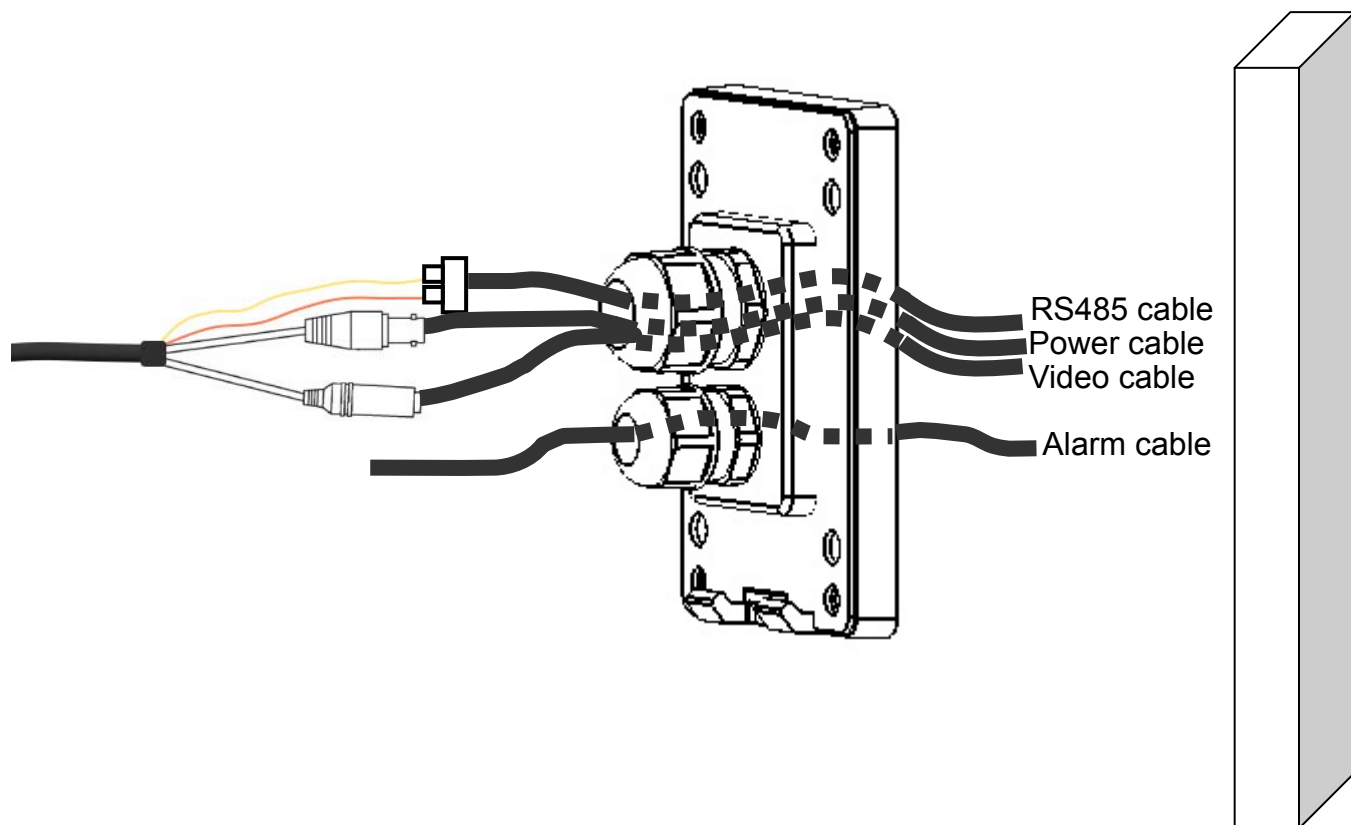

5. Screw in 4 screws for mounting the bracket base.

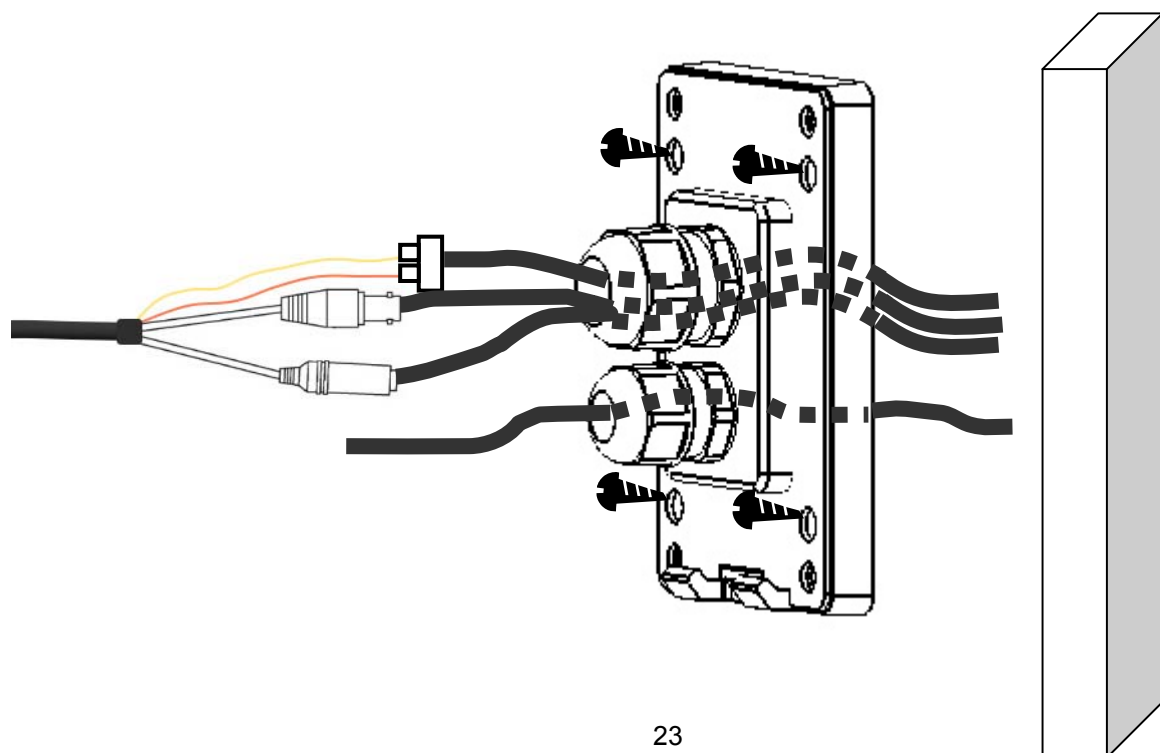

6. Thread the cable through the bracket.

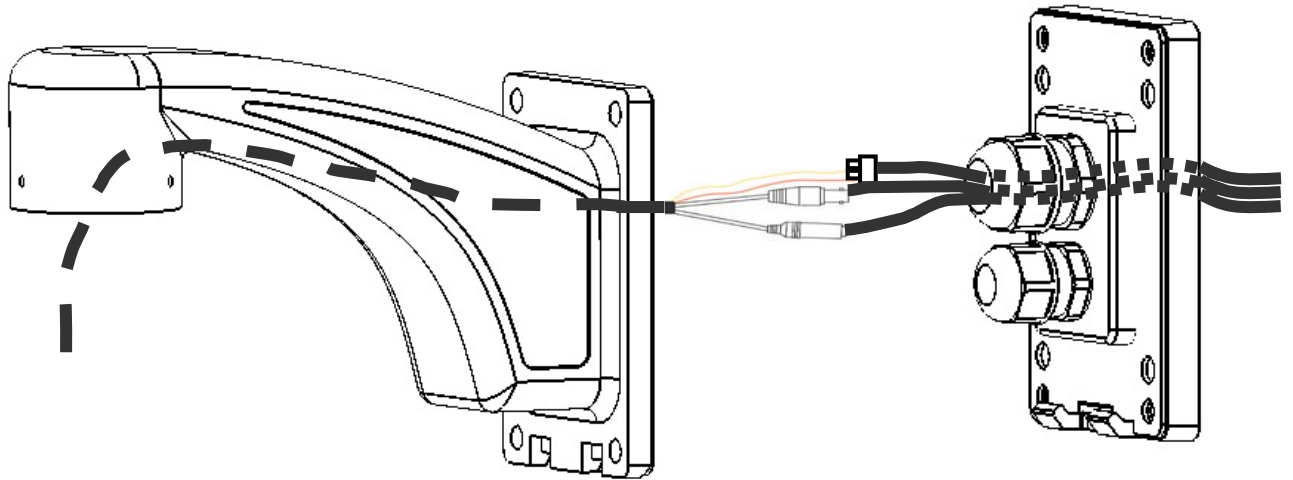

7. Screw the top housing to bracket by using a hexagon wrench.

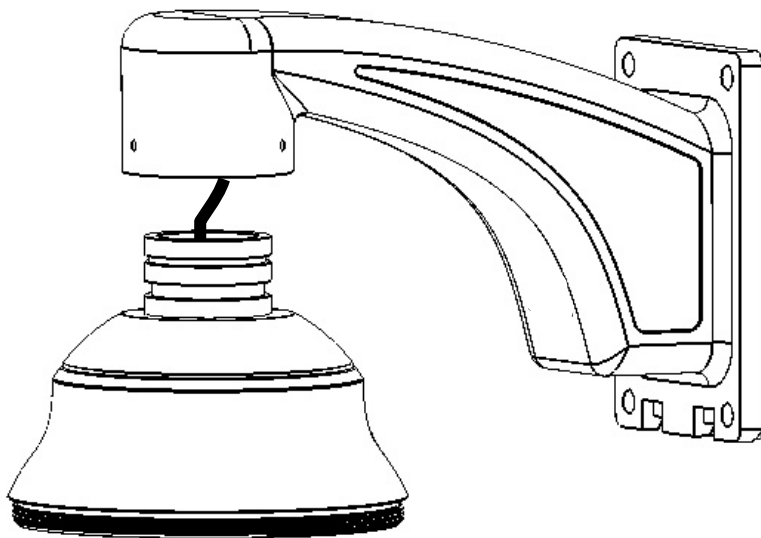

a. Locate the hook first.

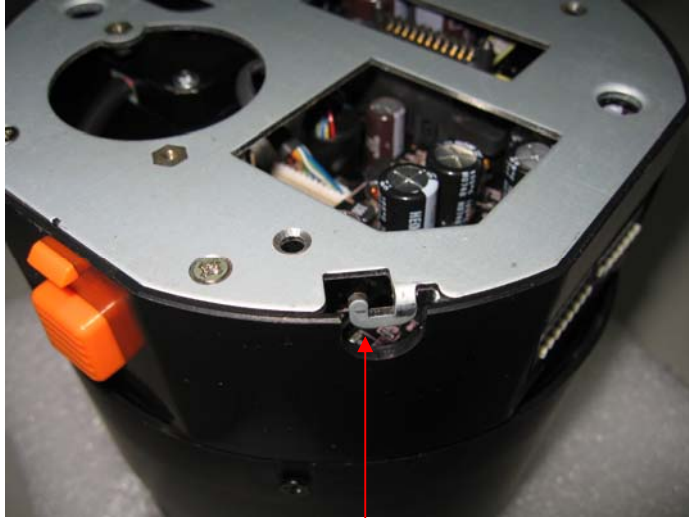

Hook

b. Clasp the rope to the hook firmly.

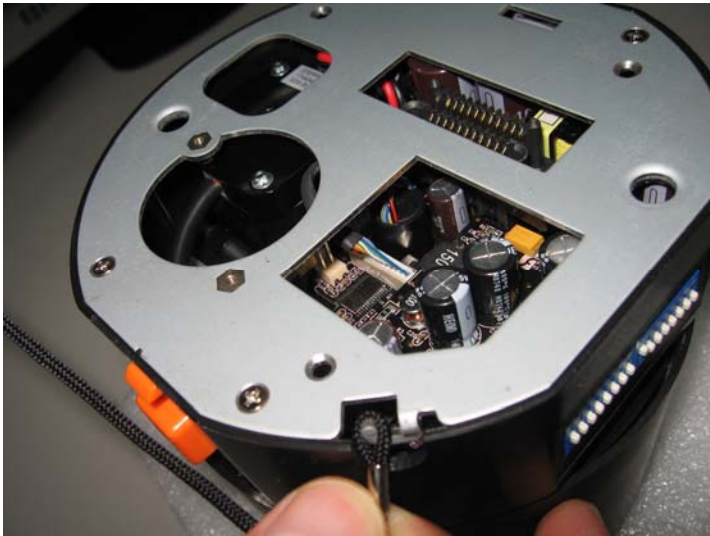

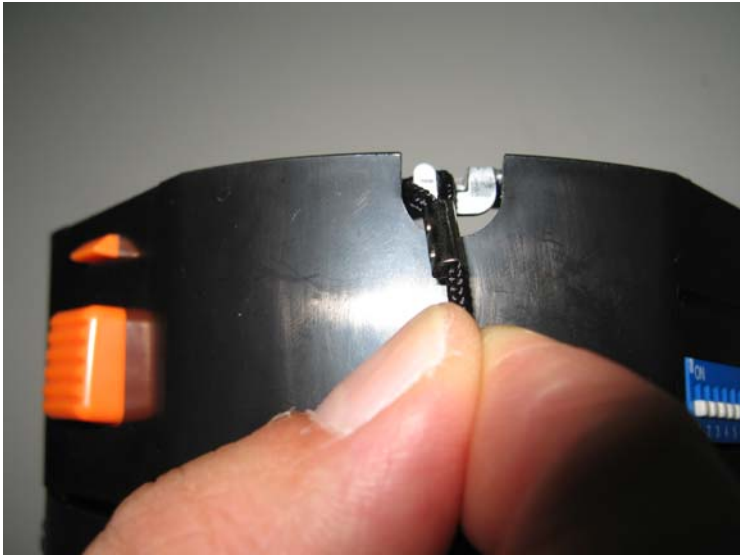

c. Done!



11. Hold and push the main body toward the bracket until it is firmly fixed to the bracket. To release it, press orange buttons at both sides of the body.

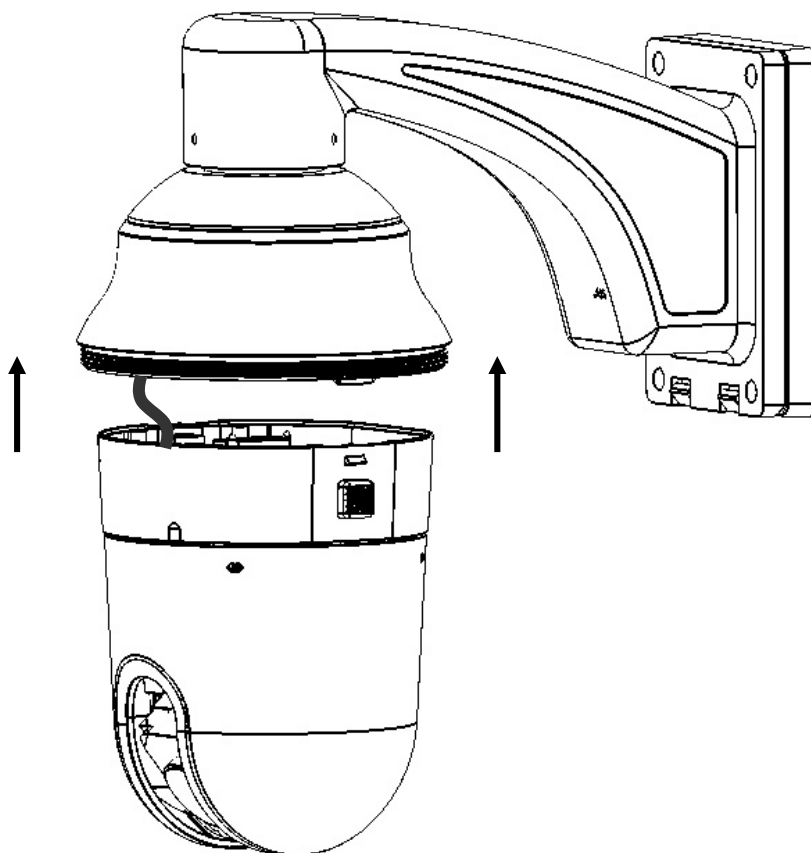

12. Twist the cover of main body to top housing clockwise until it is firmly fixed to top housing.

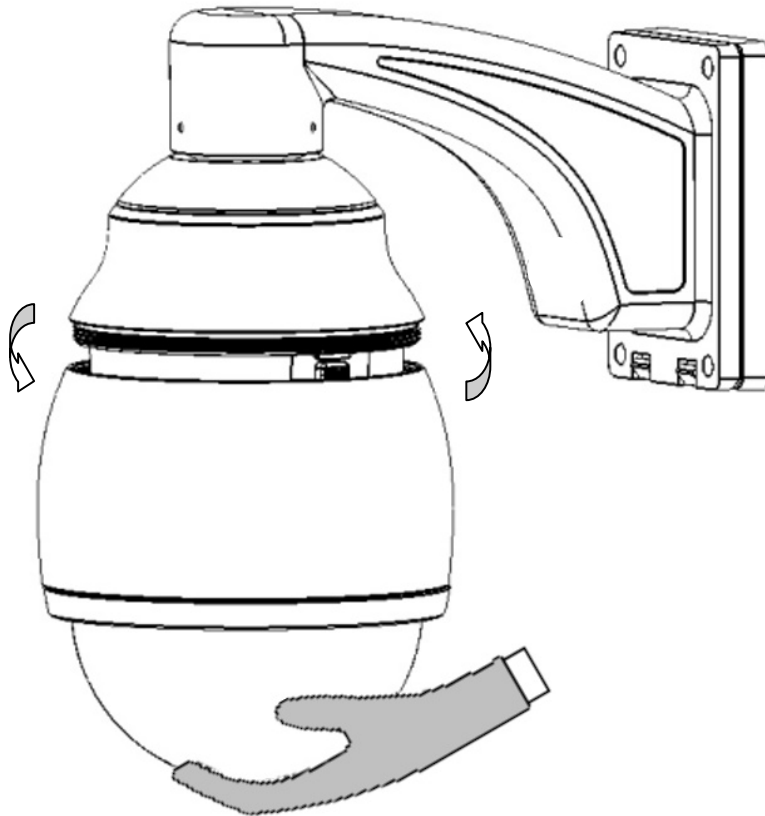

Note 1: In order to protect the bubble from dirt and scrape, please put on the gloves before installing the bubble.

Note 2: The camera module on the mechanical part is very sensitive. Please be careful when installing this part.

13. Turn on the power, and start to operate the EPTZ2700.

Note: When turning on the power, EPTZ2700 will enter self-inspection mode, and carry out a self-testing program. After finishing self-inspection, you can start to operate the EPTZ2700.

2.5. Accessories

2.5.1. EPTZ-CPMA: Ceiling Pendant Mount Adapter



The ceiling pendant mount adapter is used for installing a speed dome on the ceiling indoors or outdoors.

The extension poles are available for the pole mount.

2.5.2. EPTZ-PMA: Pole Mount Adapter



The pole adapter is used for installing a wall mount bracket to a pole indoors or outdoors.

2.5.3. EPTZ- CMA: Corner Mount Adapter



The corner mount are used for installing a wall mount bracket to a 270° corner of walls indoors or outdoors.

3. EPTZ2700/EPTZ2700I CAMERA SETUP MENU

In this section, setup and operation guide of EPTZ2700/EPTZ2700I will be introduced.

There are 8 items of the setting menu.

3.1. Structure of the Setup Menu

Press **MENU** to enter camera setup menu.

Turn the Joystick up/down to change subentries, and right/left to change the setting. If there is an arrow at the end of selection, it means that selection has a sub-menu, please press **Enter** key of keyboard to enter sub-menu.

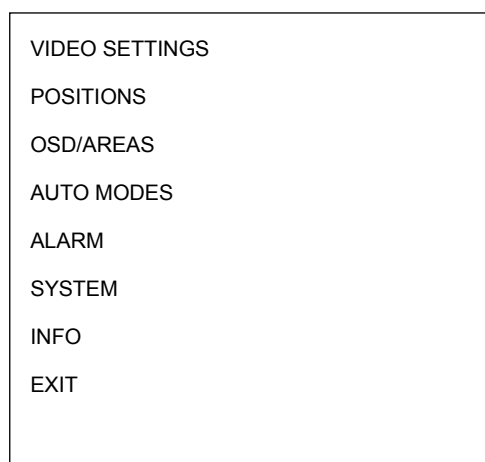

(diagram 3.1)

3.2. VIDEO SETTINGS

In main menu, turn joystick Up / Down to select VIDEO SETTINGS. Turn joystick Left / Right to enter VIDEO SETTINGS sub-menu (see diagram 3.2).

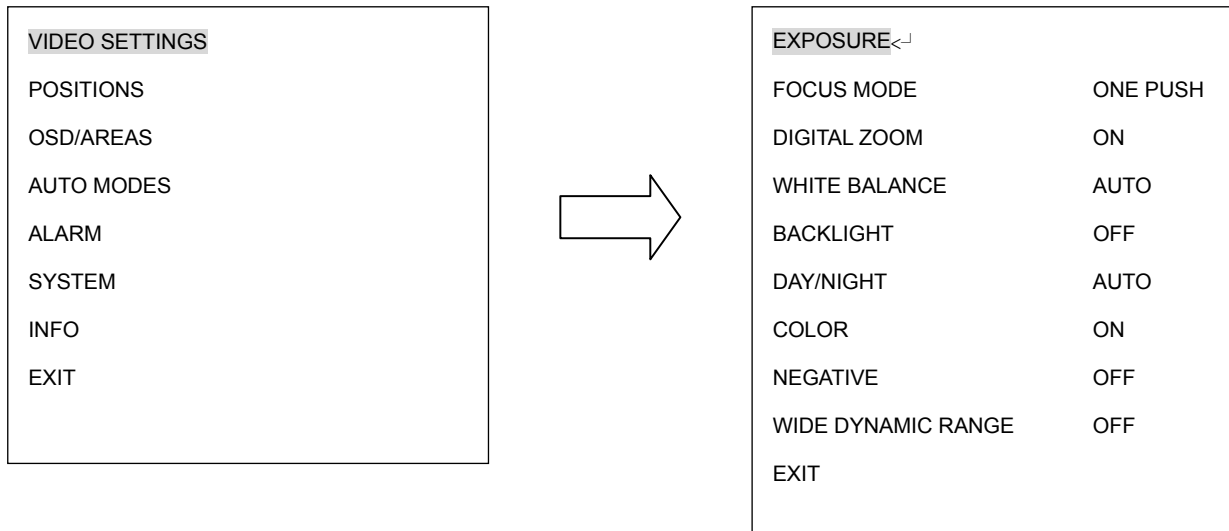

(diagram 3.2)

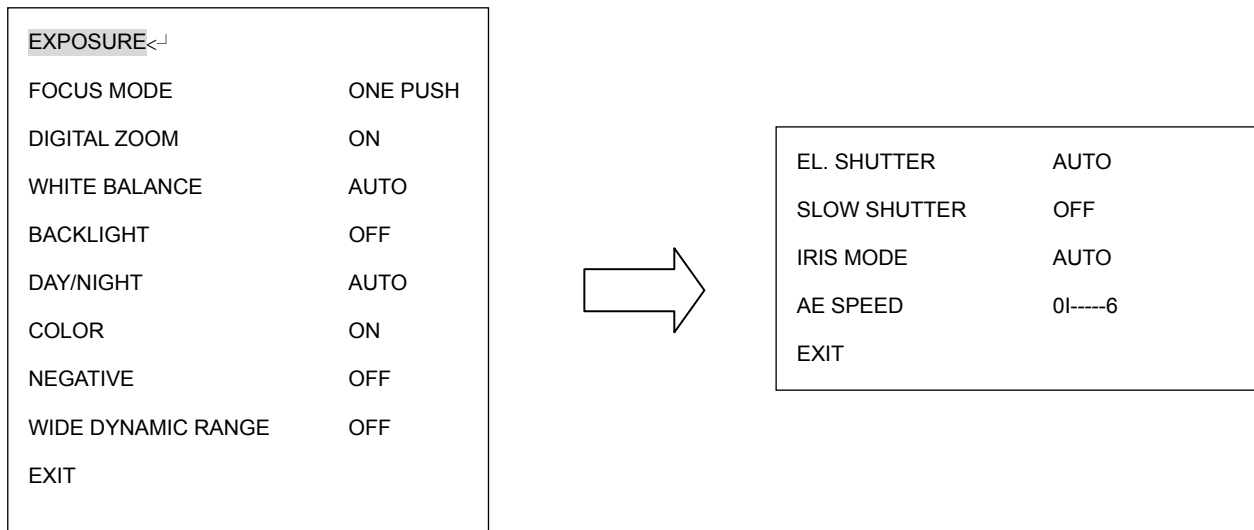

(diagram 3.3)

3.2.1. EXPOSURE

In Exposure menu, there is a sub-menu. Press **Enter** key or turn joystick Left / Right to enter Exposure sub-menu.

There are 4 options in Exposure: EL. SHUTTER, SLOW SHUTTER, IRIS MODE, and AE SPEED.

EL.SHUTTER: Select electronic shutter mode from the options of the menu. There are AUTO, A.FLK , 1/50, 1/125 , 1/250 , 1/1000 , 1/2000 and 1/10000.

AUTO: Auto electrical shutter

A.FLK: Anti-Flicker. Camera will auto adjust the shutter to reduce the flicker caused by fluorescent light.

1/60 (NTSC) and 1/50 (PAL): default auto shutter.

1/150: 1/150 sec shutter for both NTSC and PAL

1/125: 1/125 sec shutter for NTSC and PAL

1/250: 1/250 sec shutter for NTSC and PAL

1/1000: 1/1000 sec shutter for both NTSC and PAL

1/2000: 1/2000 sec shutter for NTSC and PAL

1/10000: 1/10000 sec shutter for both NTSC and PAL

SLOW SHUTTER: Slow electronic shutter. In order to enhance the view in the low lux environment, slow shutter allows more light go through the shutter. The default shutter is 1/60 sec for NTSC and 1/50 for PAL. For example, AUTO X4 means 1/60 sec x 4 = 1/15 sec for NTSC. Select from OFF, AUTO X4, AUTO X8, AUTO X12, AUTO X16, AUTO X32, FIX X2, FIX X4, FIX X8, FIX X16 and FIX X32.

OFF: Disable Slow Shutter function.

AUTO: Auto Slow Shutter. X4, X8, X12, X16, X32 means the slowest speed limit of the shutter. The camera will automatically adjust the shutter speed and limited by the selected AUTO X2, X4, X8, X12, X16, or X32 shutter speed.

FIX: Fix Speed Slow Shutter. The shutter will be fixed at the selected speed. There are FIX X2, X4, X8, X16, and X32 for selection.

NOTE: If EL. SHUTTER is selected, SLOW SHUTTER will be disabled.

IRIS MODE:

MANUAL: Manual Iris.

AUTO: Auto Iris.

EXIT: Select Exit to save settings and exit from current page.

3.2.2. FOCUS MODE

In Focus mode, we define focus type from **ONE PUSH**, **AUTO** and **Manual**.

ONE PUSH: Enable the one push trigger focus mode. The focus lens holds the same position until the next trigger command is received. This function prevents the wrong focus in dark.

AUTO: Auto focus is enabled. It automatically adjusts the focus position to maximize the high frequency content of the picture in a center measurement area, taking into consideration the high luminance and strong contrast components.

MANUAL: Enable the manual focus mode.

3.2.3. DIGITAL ZOOM

Digital zoom enable or disable.

OFF: Disable a digital zoom.

2X, 4X, 8X, 10X: Enable a digital zoom with multiple times zoom for selection.

3.2.4. WHITE BALANCE

White Balance has the following modes:

AUTO: this mode computed the white balance value output using color information from the entire screen. It outputs the proper value using the color temperature radiating from a black subject based on a range of values.

INDOOR: Camera's white balance is fixed to indoor 3200 K.

OUTDOOR: Camera's white balance is fixed to outdoor 5100 K.

3.2.5. BACKLIGHT

This is the function of Back Light Compensation. When the background of subject is too bright, or when the subject is too dark due to shooting in AE mode, back light compensation will make the subject appear clearer.

ON: Enable Back Light Compensation.

OFF: Disable Back Light Compensation.

3.2.6. DAY/NIGHT

In Day/Night, we define the ICR (IR Cut-Removable) mode settings. The camera is built-in an infrared (IR) Cut-Filter which can be disengaged from the image path for increased sensitivity in low light environments.

Select from **AUTO**, **DAY** and **NIGHT**

NIGHT: IR cut filter is always removed (ICR ON).

DAY: IR cut filter is always attached (ICR OFF).

AUTO: Auto Day/Night mode switch. The camera will automatically switch the settings needed for attaching or removing the IR cut filter. With a set level of darkness, the IR cut filter is automatically disabled (ICR ON), and the infrared sensitivity is increased. With a set level of brightness, the IR cut filter is automatically enabled (ICR OFF).

3.2.7. COLOR

In Color, we define color of the image.

Select from **ON** and **OFF**.

ON: Color image

OFF: B/W image

3.2.8. NEGATIVE

In Negative mode, it will switch ON/OFF the negative art image output.

Select from **ON** and **OFF**.

3.2.9. WIDE DYNAMIC RANGE

In Wide Dynamic Range (WDR), we define wide dynamic range from **AUTO**, **ON** and **OFF**.

This function is effective when shooting images against the sun, or when shooting a very bright subject.

ON: WDR function is fixed to ON.

OFF: WDR function is fixed to OFF.

AUTO: WDR function is changed to ON or OFF automatically according to backlight condition of the object.

WDR is ON automatically, when the object is in boundary of backlight condition.

WDR is OFF automatically, when the object is out of boundary of backlight condition.

Notice: When the wide dynamic range is ON, some part of the image may appear solarized. This is normal for the wide dynamic range, and is not a camera malfunction.

3.2.10 EXIT

Select Exit to save settings and exit from current page.

3.3. POSITIONS

In main menu, turn joystick Up or Down to select POSITION option. Press **Enter** key or turn joystick Left / Right to enter POSITION sub-menu (See diagram 3.4).

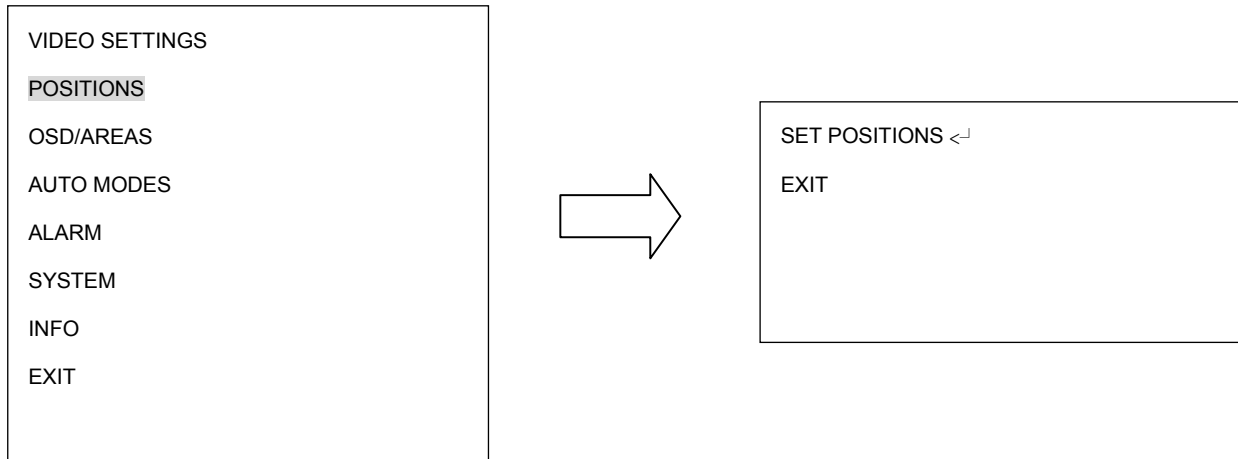

(diagram 3.4)

Press **Enter** key of keyboard to enter SET POSITIONS sub-menu.

Turn the joystick Left / Right to select preset position. There are totally 36 preset positions can be set. Once the preset position is selected, go to RETURN and turn the joystick Left / Right to exit from current page.

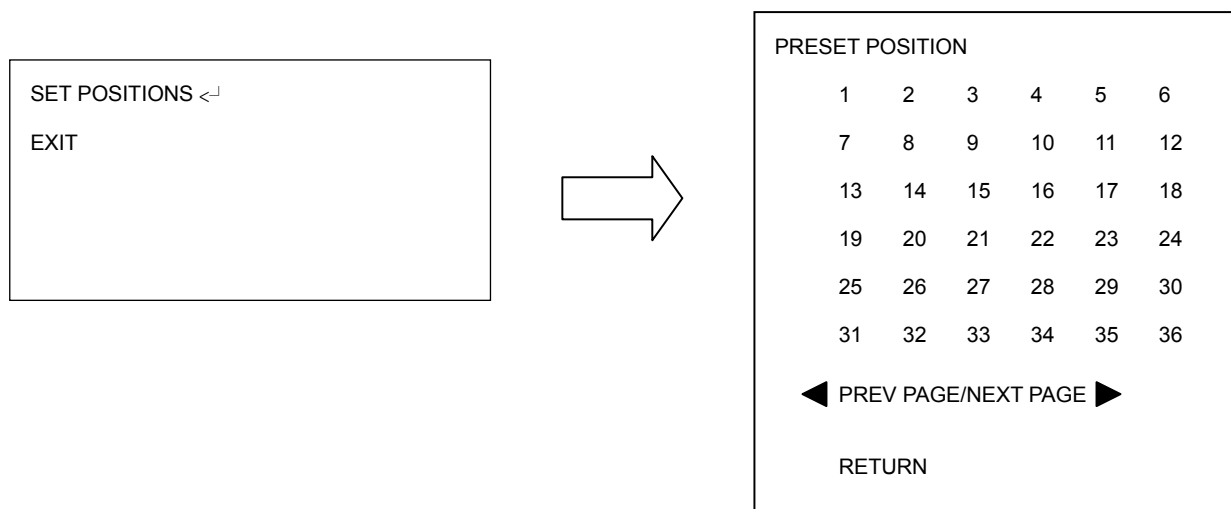

(diagram 3.5)

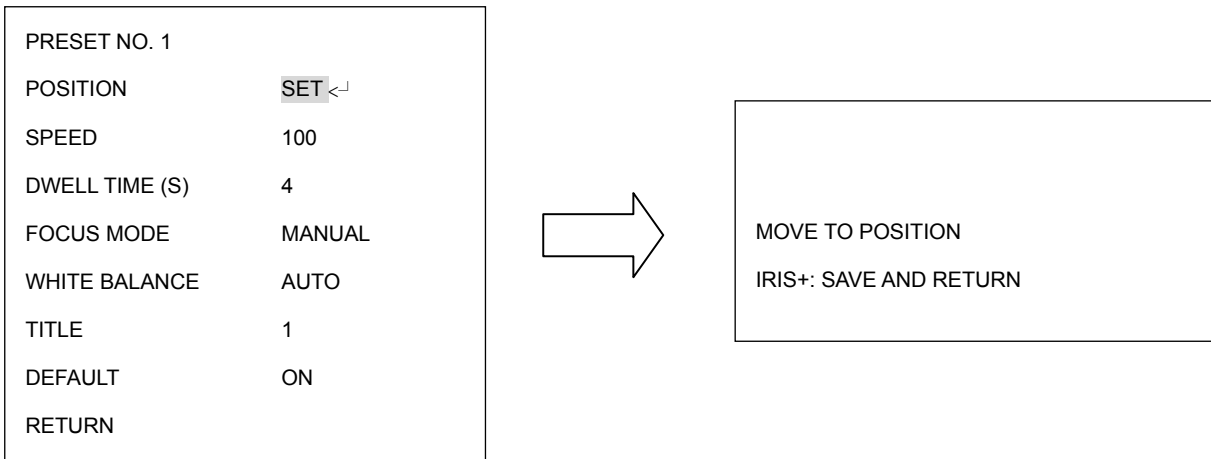

(diagram 3.6)

POSITION: Select from SET and CLEAR.

SET: Select SET and press **Enter** key of keyboard, you will be entered to a sub-menu.

Turn the joystick to your desired position. Once the position is confirmed, press **IRIS+** key of keyboard to save setting and return to previous menu.

Clear: Select Clear and press **Enter** key of keyboard, and the POSITION will be cleared.

You will automatically go back to the sub-menu of PRESET POSITION. (see diagram 3.7).

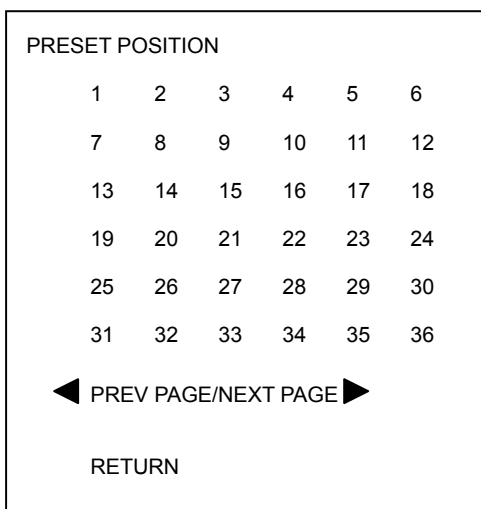

(diagram 3.7)

SPEED: Select the speed for the preset position. The value is from 1 to 255 and 255 is the highest speed.

DWELL TIME (S): Select the dwell time (in second) for the preset position from 1 to 99.

FOCUS MODE: Select focus mode for the preset position from MANUAL, ONE PUSH and AUTO.

WHITE BALANCE: Select the white balance for the preset position from Auto, Indoor and outdoor.

TITLE: Enter title name for the preset position. Turn the joystick Up or Down to select the character. Turn the joystick Left or Right to select the character position. Once the title is inputted, turn the joystick to the last character and keep turning right again to return to previous mode.

DEFAULT: Select ON to set the preset position to default value.

EXIT: Select Exit to save settings and exit from current page.

3.4. OSD/AREAS

In main menu, turn joystick Up or Down to select OSD/AREAS. Turn joystick Left or Right to enter OSD/AREAS sub-menu (see diagram 3.8)

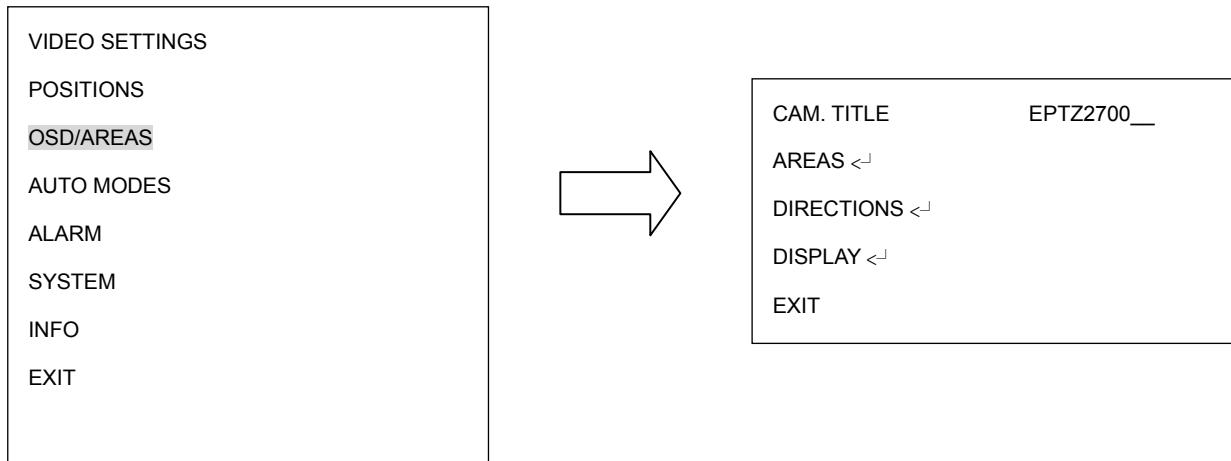

(diagram 3.8)

3.4.1. CAM. TITLE

Enter title name for the camera. Turn the joystick Up or Down to select the character. Turn the joystick Left or Right to select the character position. Once the title is inputted, turn the joystick to the last character and keep turning right again to return to previous mode.

3.4.2. AREAS

Press **Enter** key of keyboard or turn joystick Left/Right to enter AREAS sub-menu.

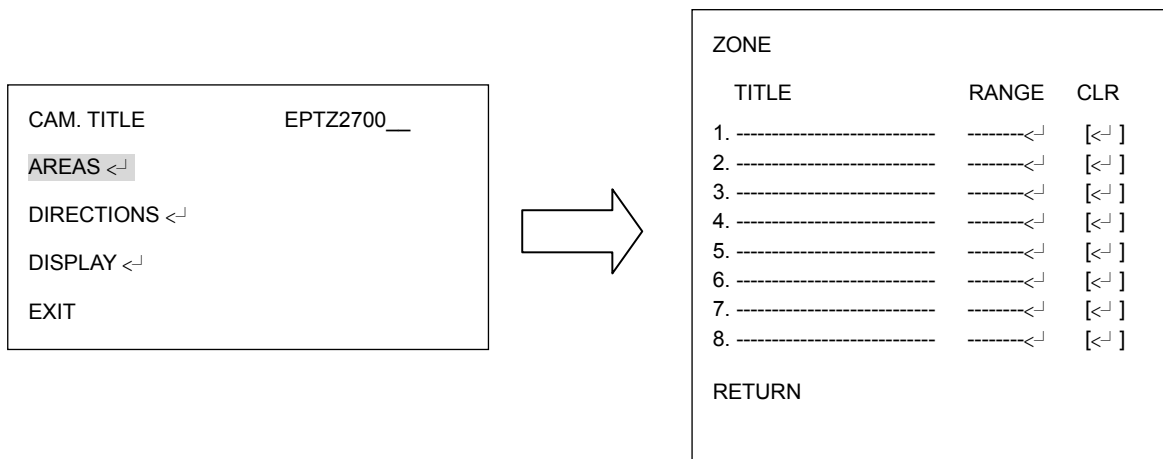

(diagram 3.9)

In zone menu, you can set a zone and name it, when the speed dome turns to the zone you set, it will display zone name on the screen (only if "OSD/AREAS->Display -> Zone" is set as "YES"). Turn the joystick to Up/Down to select the character. Turn the joystick Left or Right to select the character position. Once the title is inputted, turn the joystick Left/Right to go "Range" section, and press Enter key to enter Range sub-menu. Use the joystick to move speed dome to its left position. Press **IRIS+** key to save left position setting and go to next step or press **IRIS-** to cancel.

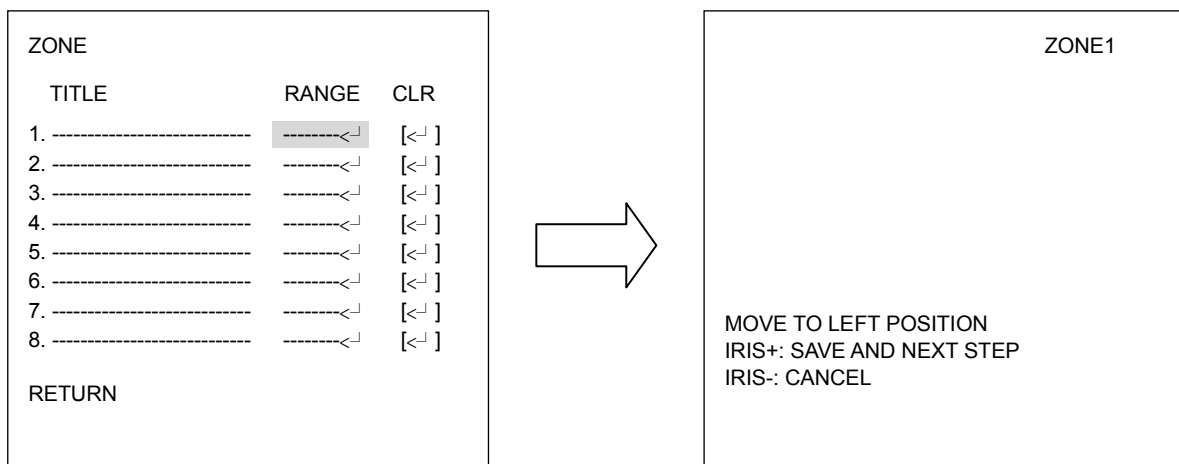

(diagram 3.10)

Use the joystick to move speed dome to its right position. Press **IRIS+** or **IRIS-** key to save and return.

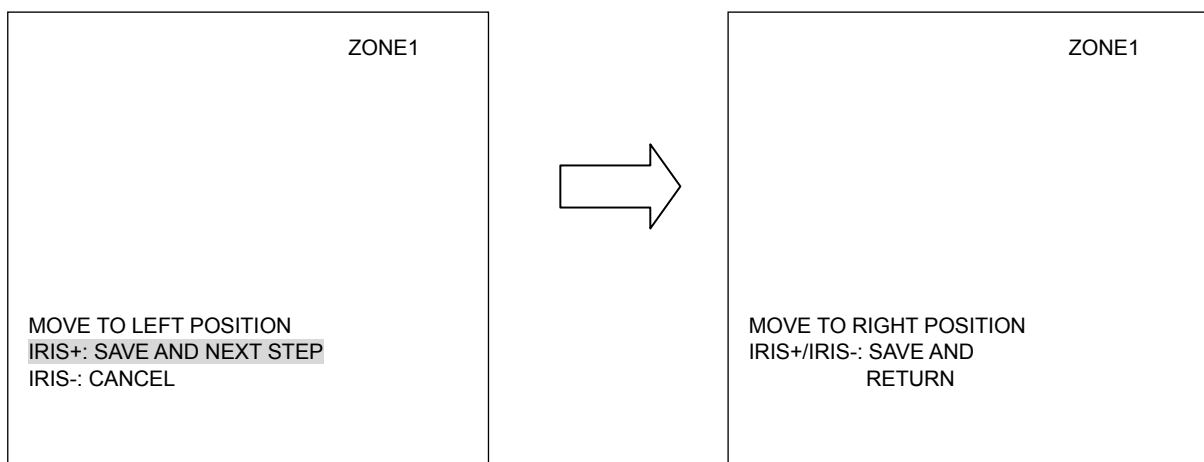

(diagram 3.11)

Turn joystick Right/Left to highlight the zone you have set and turn the joystick Up/Down to select another zone number. If you wish to clear the zone you have set, go to “CLR” and press Enter key.

3.4.3. DIRECTIONS

Press **Enter** key of keyboard or turn joystick Left/Right to enter DIRECTIONS sub-menu (see diagram 3.12)

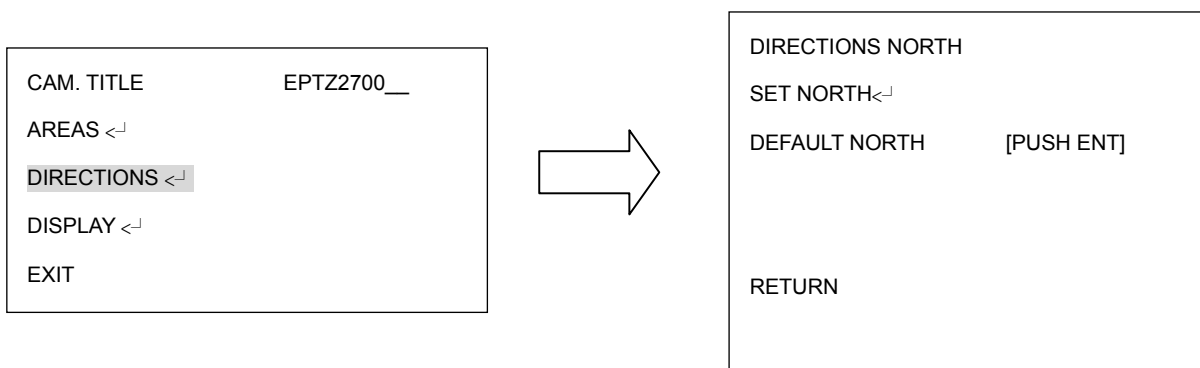

(diagram 3.12)

Press **Enter** key of keyboard or turn joystick Left/Right to enter DIRECTIONS sub-menu (see diagram 3.13)

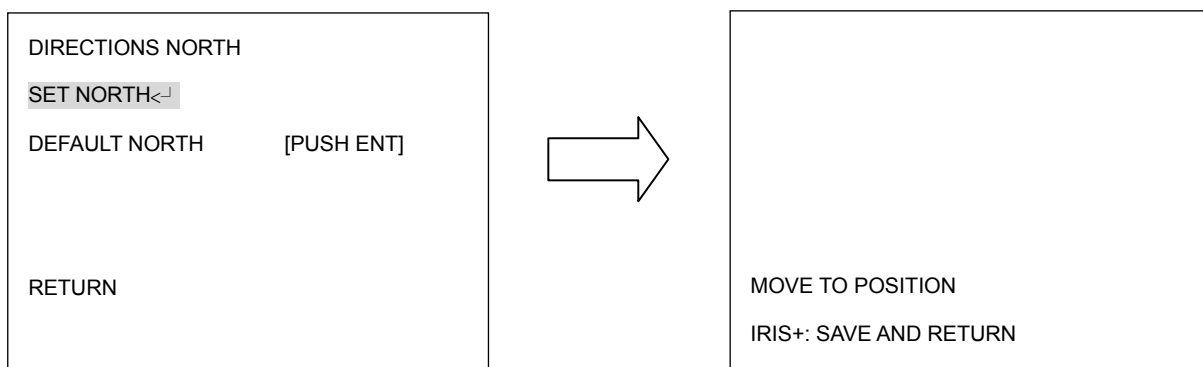

(diagram 3.13)

1. Press **Enter** key of keyboard or turn joystick Left/Right to enter Set North position menu.
2. Move the joystick to North position.

3. Press IRIS+ key of keyboard to save and return.

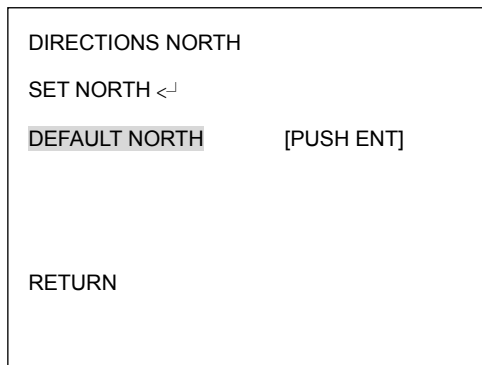

(diagram 3.14)

4. Go to “DEFAULT NORTH” and press Enter key to set the north position as default north position.

5. Go to Return and turn joystick Left/Right to return to previous menu.

3.4.4. DISPLAY

Press **Enter** key of keyboard or turn joystick Left/Right to enter DISPLAY sub-menu (see diagram 3.15)

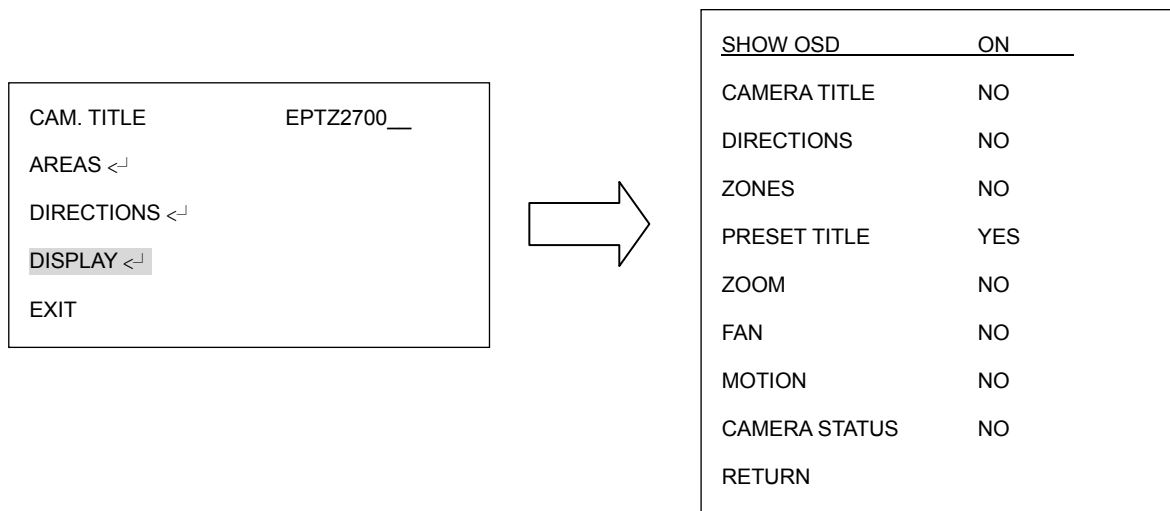

(diagram 3.15)

1. SHOW OSD:

ON: show OSD of Camera Title, Directions, Zones, Preset Title, Motion, Zoom, Fan and Camera Status.

OFF: do not show OSD.

2 SEC: show OSD for 2 seconds.

5 SEC: show OSD for 5 seconds.

10 SEC: show OSD for 10 seconds.

2. CAMERA TITLE

YES: show camera title

NO: do not show camera title

3. DIRECTIONS

YES: show directions

NO: do not show directions

4. ZONES

YES: show zones

NO: do not show zones

5. PRESET TITLE

YES: show preset title

NO: do not show preset title

6. ZOOM

YES: show zoom multiple when zoom in or zoom out.

NO: do not show zoom multiple.

7. FAN

YES: show fan indication when fan is enabled.

NO: do not show fan indication.

8. CAMERA STATUS

YES: shows camera status

NO: do not show camera status

9. RETURN

Turn joystick Left/Right to return to previous menu

3.4.5. EXIT

Select Exit to save settings and exit from current page.

3.5. AUTO MODES

In main menu, turn joystick Up/Down to select AUTO MODES. Turn joystick Left/Right to enter AUTO MODES sub-menu (See diagram 3.16)

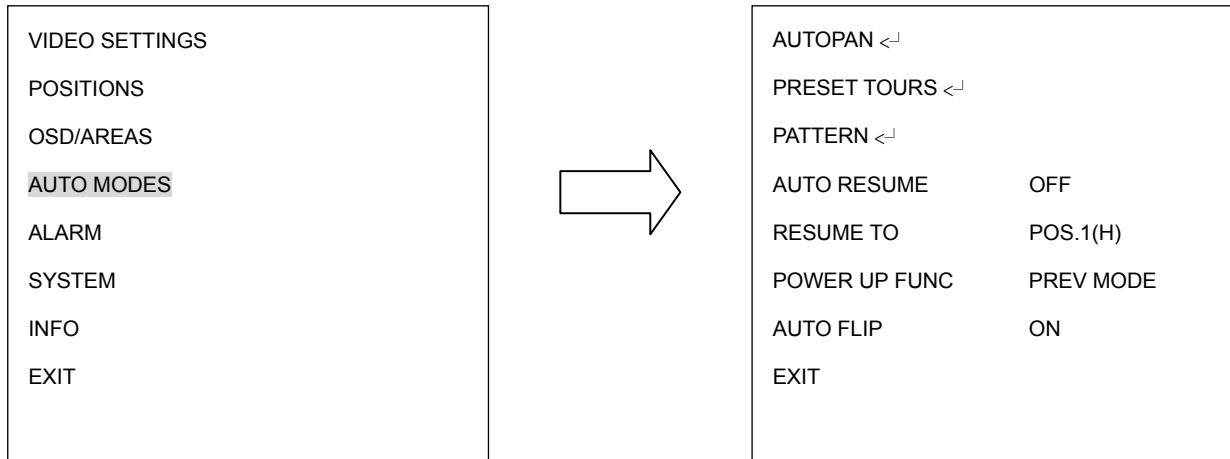

(diagram 3.16)

3.5.1. AUTOPAN

Press **Enter** key of keyboard or turn joystick Left/Right to enter AUTOPAN sub-menu (see diagram 3.17)

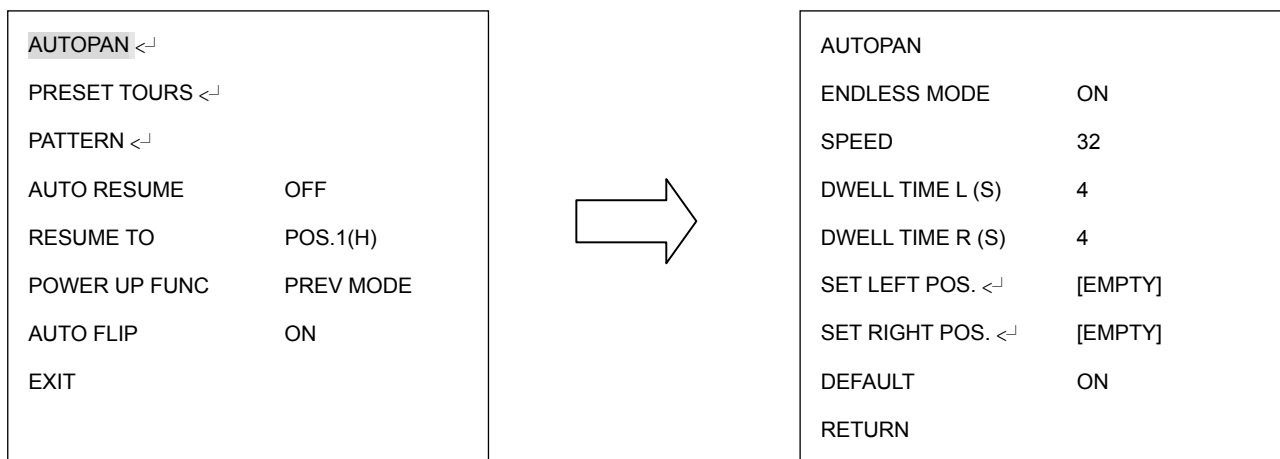

(diagram 3.17)

a. ENDLESS MODE

ON: enable endless mode. The speed dome will perform 360 degree endless

auto-pan.

OFF: disable endless mode. The speed dome will perform auto-pan between position left and position right.

b. SPEED

Select speed from 1~255 and 255 is the highest speed.

c. DWELL TIME L (S)

Select dwell time of the left position from 1~99 seconds.

d. DWELL TIME R (S)

Select dwell time of the right position from 1~99 seconds

e. SET LEFT POS.

Press Enter key or turn the joystick Left/Right to enter SET LEFT POS. menu. Turn the joystick to the position where you wish to set Left position. Press **IRIS+** key of keyboard to save setting and return to previous menu. (see diagram 3.18)

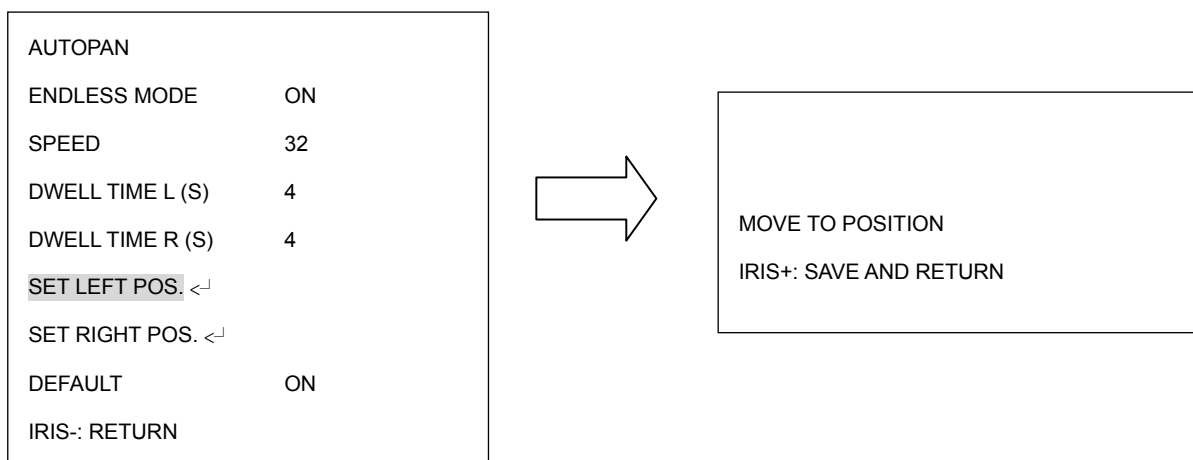

(diagram 3.18)

f. SET RIGHT POS.

Press Enter key or turn the joystick Left/Right to enter SET RIGHT POS. menu. Turn the joystick to the position where you wish to set RIGHT position. Press IRIS+ key of keyboard to save setting and return to previous menu. (see diagram 3.19)

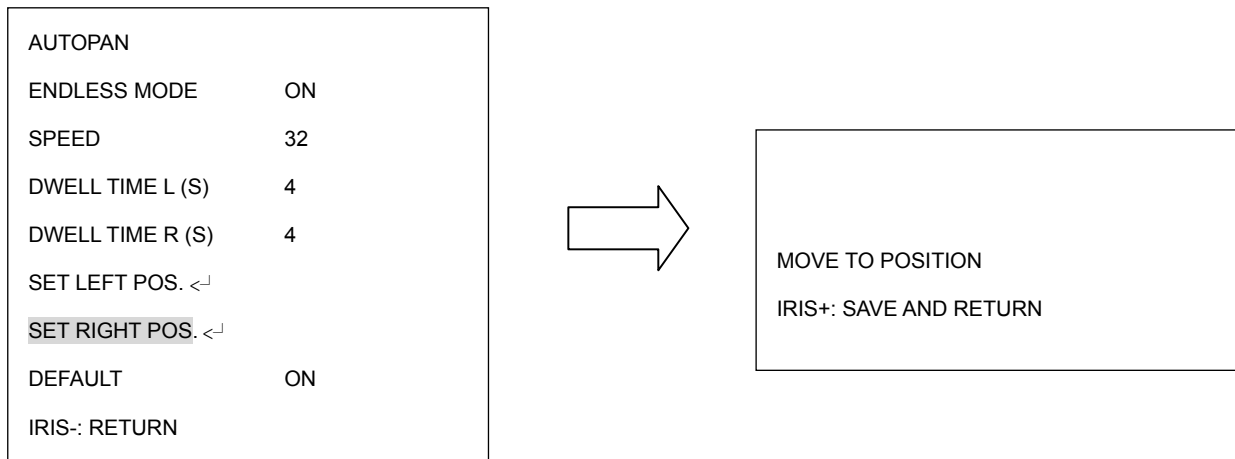

(diagram 3.19)

g. DEFAULT

ON: all settings in AUTOPAN menu will be returned to default values.

OFF: the setting in AUTOPAN menu is not default value.

h. RETURN

Turn joystick Left/Right to return to previous menu

3.5.2. PRESET TOURS

Press Enter key or turn the joystick Left/Right to enter PRESET TOURS sub-menu (see diagram 3.20)

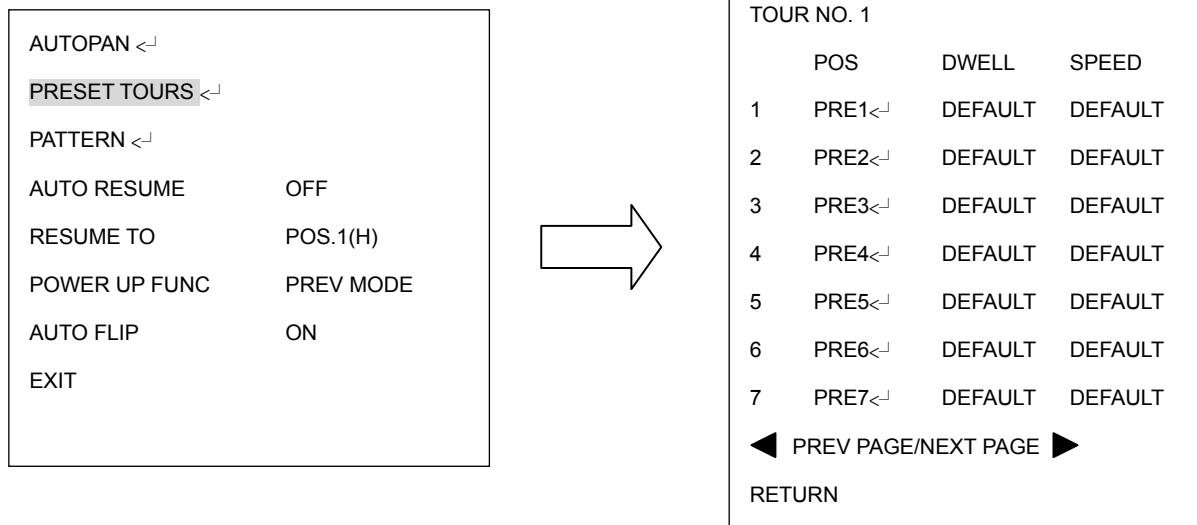

(diagram 3.20)

- a. Tour NO.: Turn the joystick Left/Right to select tour number first.
- b. PRE: Turn the joystick Left/Right to select preset position. Press **Enter** key of keyboard to go next setting. Max. 16 positions can be set for a tour.
- c. DWELL: Turn the joystick Up/Down to set dwell time of the tour from 1~99 sec or default.
- d. SPEED: Turn the joystick Right after setting dwell time. Turn the joystick Up or Down to select tour speed from 1 ~255 or default. Press **Enter** key when you finish Tour setting of preset position.
- e. PREV PAGE/NEXT PAGE: Turn the joystick Left to go previous page or turn joystick Right to go next page.
- f. RETURN: Turn joystick Left/Right to return to previous menu.

3.5.3. PATTERN

Press **Enter** key of keyboard to enter PATTERN sub-menu (see diagram 3.21)

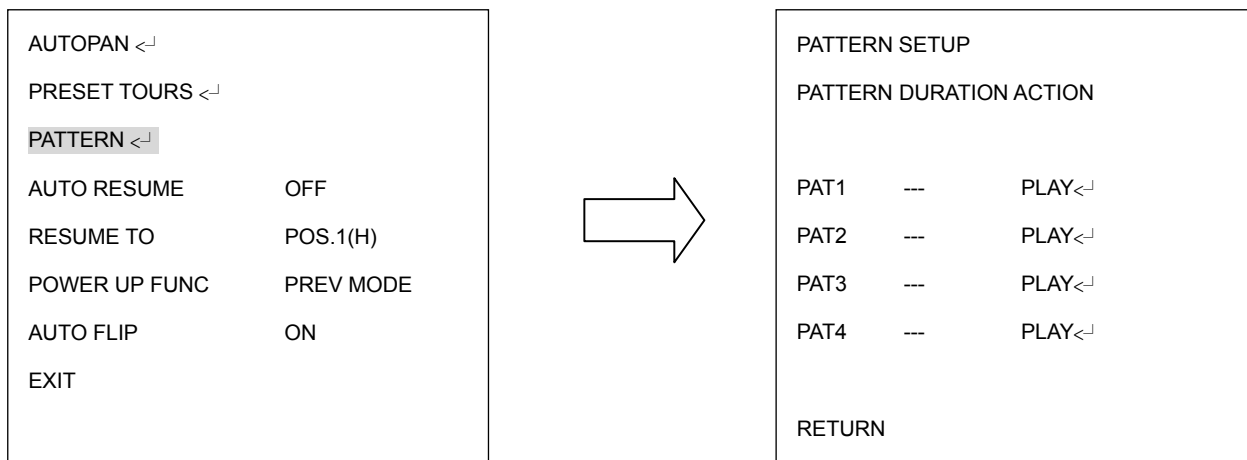

(diagram 3.21)

- a. Turn the joystick Up or Down to select pattern number.
- b. Turn the joystick Left or Right to select action mode, either **PLAY** or **SET**.
- c. Select **SET** and press **Enter** key of keyboard.

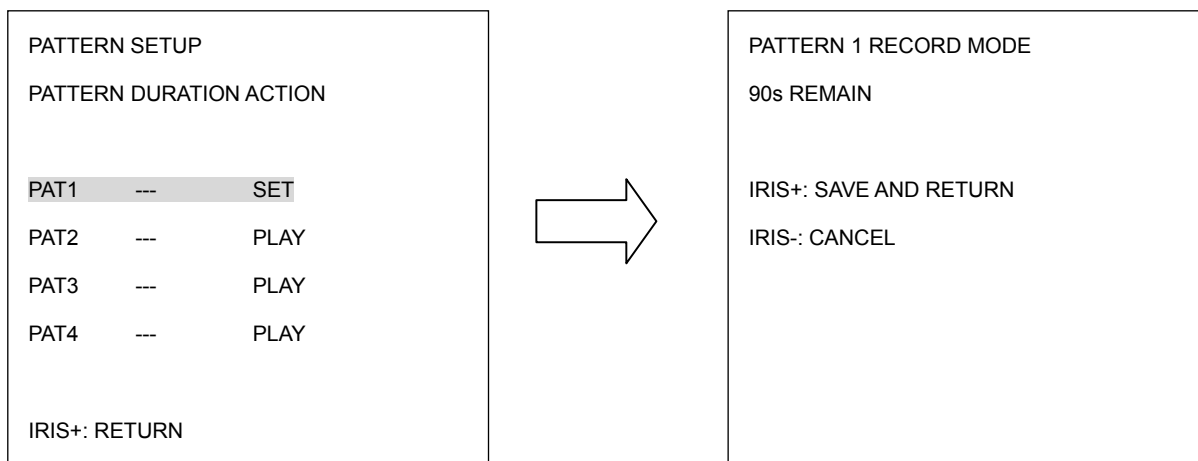

(diagram 3.22)

- d. Turn the joystick to record the tour you wish to set. Press **IRIS+** when you finish setting pattern tour. Press **IRIS-** if you wish to cancel this action. At duration column of PATTERN SETUP menu, you will see the duration time of pattern you set.

- e. When you return to PATTERN SETUP menu, turn the joystick Left/Right to **PLAY**. Press **Enter** key of keyboard. The camera starts to run the pattern tour you set. The camera keeps playing the pattern until you press **IRIS-** to cancel playing and it will return to PATTERN SETUP menu.

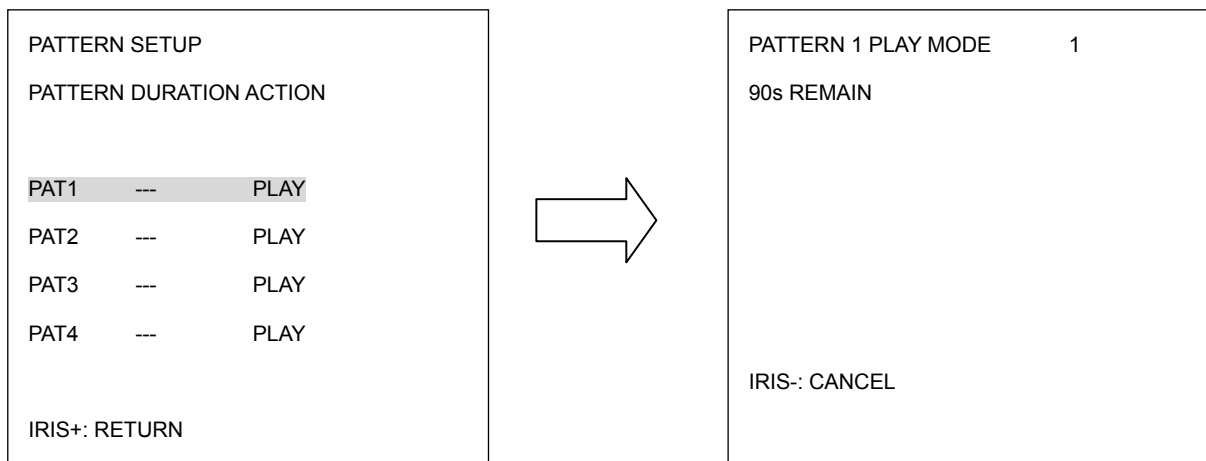

(diagram 3.23)

- f. **RETURN:** Turn joystick Left/Right to return to previous menu.

3.5.4. AUTO RESUME

Return to previous mode, if no action for a period.

Turn the joystick Left/Right to set AUTO RESUME. Auto Resume is selectable from OFF, After 30S, After 1M, after 5M, After 10M, After 30M and After 60M. After this period of time, speed dome will resume to the mode you set in "RESUME TO". By selecting OFF, this function will be disabled.

3.5.5. RESUME TO

Turn the joystick Left/Right to select the mode to resume to. It is selectable from PREV MODE, POS.1 (H), TOUR1, PAT.1 and AUTOPAN.

3.5.6. POWER UP FUNC

Turn the joystick Left or Right to select the mode to return to when power failure occurs. It is selectable from PREV MODE, POS.1 (H), TOUR1, PAT.1, AUTOPAN and OFF

3.5.7. AUTO FLIP

Select ON to enable Auto Flip function or select OFF to disable Auto Flip.

3.5.8. EXIT

Exit from the current menu.

3.6. ALARM

In main menu, turn joystick Up or Down to select ALARM. Turn joystick Left or Right to enter ALARM sub-menu (see diagram 3.24)

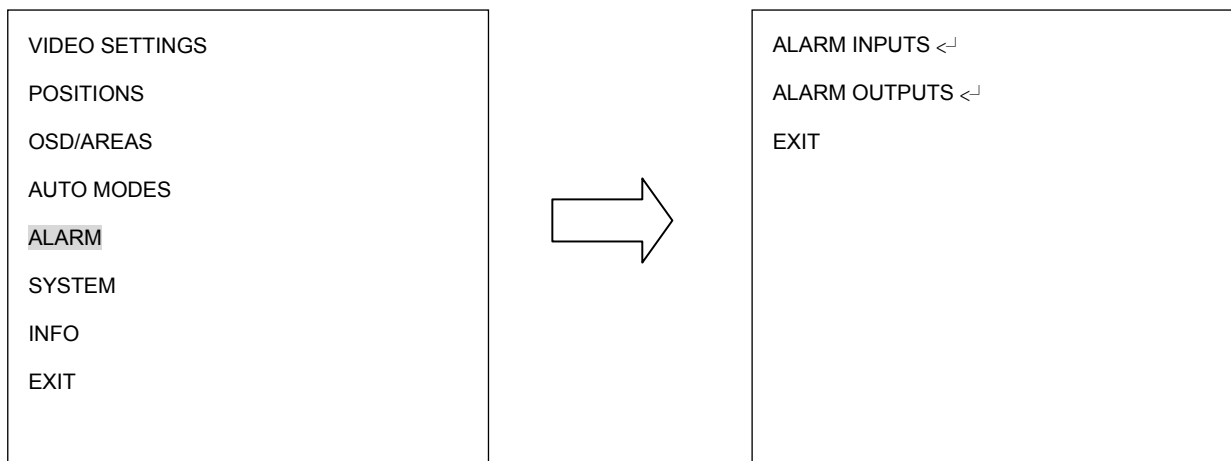

(diagram 3.24)

3.6.1. ALARM INPUTS

Press **Enter** key of keyboard to enter ALARM INPUTS sub-menu. (see diagram 3.26)

- a. Go to INPUT NO. selection and turn the joystick Left/Right to select alarm input

number from 1 ~4.

- b. Type: Select Normal Close (NC), Normal Open (NO), NIGHT NC, NIGHT NO, or OFF for alarm type.

NC: Enable a normal close alarm input.

NO: Enable a normal open alarm input.

NIGHT NC: Set camera at night mode with normal close alarm input. When there is event triggered, the camera will be changed to day mode.

NIGHT NO: Set camera at night mode with normal open alarm input. When there is event triggered, the camera will be changed to day mode.

OFF: Disable alarm input.

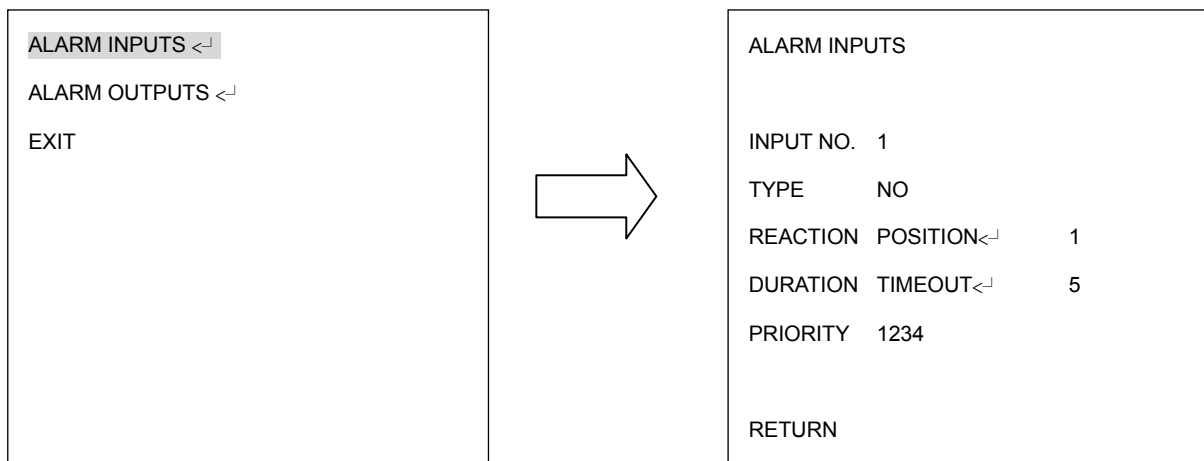

(diagram 3.25)

- c. REACTION: The action will be taken when alarm is triggered.

OFF: No reaction will be taken when alarm is triggered.

POSITION: When the alarm is triggered, speed dome will go to the preset position.

Turn the joystick Left or Right to select on Position and press **Enter** key to select position number. Turn joystick Left/Right to make selection. It is selectable from 1~192. Press **Enter** key again to confirm selection.

PATTERN: When the alarm is triggered, speed dome will run the pattern. Turn the

joystick Left/Right to select on Pattern and press **Enter** key to select pattern number. Turn joystick Left/Right to make selection. It is selectable from 1~4. Press **Enter** key again to confirm selection.

TOUR: When the alarm is triggered, speed dome will run the tour. Turn the joystick Left or Right to select on Tour and press **Enter** key to select tour number. Turn joystick Left or Right to make selection. It is selectable from 1~16. Press **Enter** key again to confirm selection.

d. DURATION: Duration of alarm input.

TIMEOUT: Turn the joystick Left or Right to select on TIMEOUT and press **Enter** key to select time-out. Time-out is selectable from 1~99. Press **Enter** key again to confirm selection.

LATCHED: Turn the joystick Left or Right to select on LATCHED. The alarm output will not stop until there is any operation on keyboard.

TRANSPARENT: Turn the joystick Left or Right to select on TRANSPARENT. The alarm output will not stop until the alarm is stopped.

e. PRIORITY: Turn the joystick Left or Right to select alarm input priority, it is selectable from 1234/2341/3412/4123.

f. RETURN: Turn joystick Left/Right to return to previous menu.

3.6.2. ALARM OUTPUTS

Press **Enter** key of keyboard to enter ALARM OUTPUTS sub-menu. (see diagram 3.26)

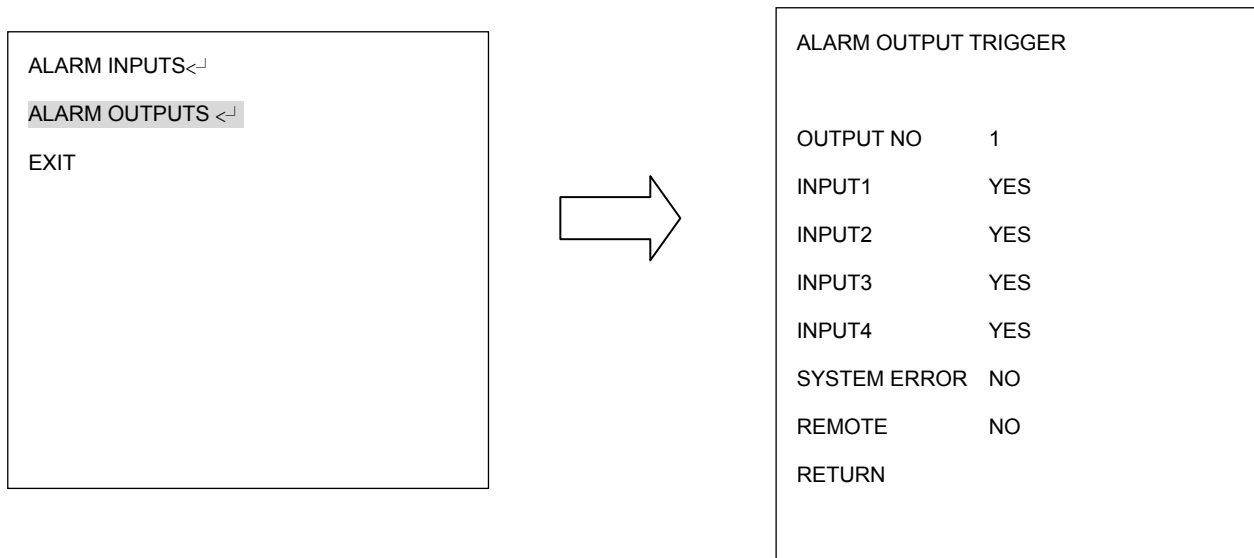

(diagram 3.26)

- a. OUTPUT NUM: Select Output number from 1~2.
- b. INPUT1: Select YES to enable Alarm input 1 for the alarm output selected. Select NO to disable Alarm input 1.
- c. INPUT2: Select YES to enable Alarm input 2 for the alarm output selected. Select NO to disable Alarm input 2.
- d. INPUT3: Select YES to enable Alarm input 3 for the alarm output selected. Select NO to disable Alarm input 3.
- e. INPUT4: Select YES to enable Alarm input 4 for the alarm output selected. Select NO to disable Alarm input 4.
- f. MOTION: Select YES to have alarm output triggered when a motion event is detected. Select NO to disable this function.
- g. SYSTEM ERROR: Select YES to have alarm output triggered when system error occurs. Select NO to disable this function.
- h. REMOTE: Select YES to have alarm output triggered when RS485 failure occurs.

Select NO to disable this function.

- i. RETURN: RETURN to the previous menu.

3.6.3. EXIT

Exit from the current menu.

3.7. SYSTEM

In main menu, turn joystick Up/Down to select SYSTEM. Turn joystick Left/Right to enter SYSTEM sub-menu (see diagram 3.27)

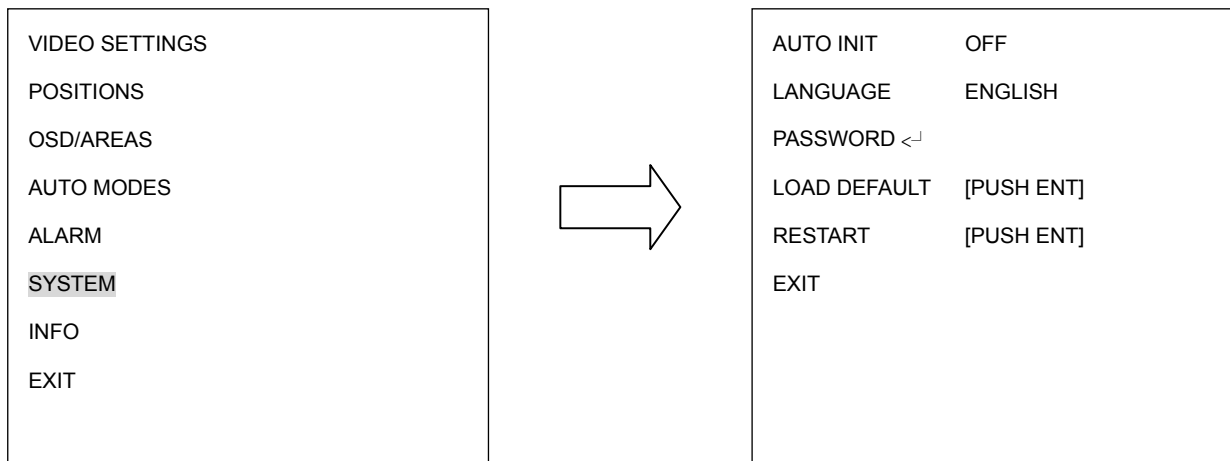

(diagram 3.27)

- a. AUTO INIT: Select auto initiation time from OFF, DAILY, WEEKLY. Speed dome will automatically initiate and return to the previous position by maintaining all the settings you have done.
- b. LANGUAGE: Select language. The current version only supports English version.
- c. PASSWORD: Press **Enter** key or turn joystick Left/Right to enter password sub-menu.

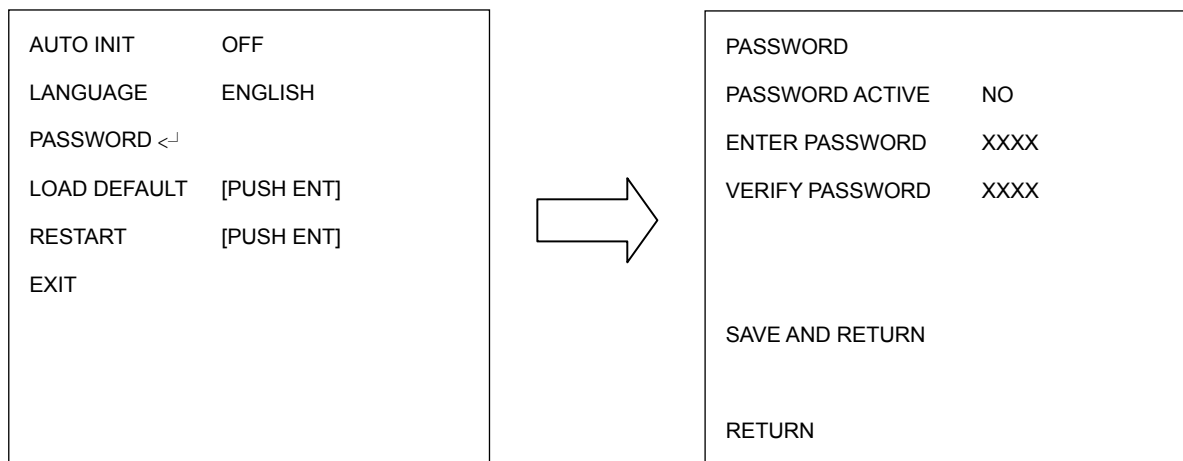

(diagram 3.28)

PASSWORD ACTIVE: Select YES to activate password mode. Select NO to disable password mode.

ENTER PASSWORD: Enter the password

VERIFY PASSWORD: Enter the password again to confirm your input.

Press **IRIS+** key to save and return to previous menu. Press **IRIS-** key to cancel.

- d. **SAVE AND RETURN**: Turn joystick Left/Right to save the changes and return to previous menu.
- e. **RETURN**: Turn joystick Left/Right to return to previous menu without saving changes.
- f. **LOAD DEFAULT**: Press Enter key to load default values, all values will return to
- g. **EXIT**: Exit from current menu.

3.8. INFO

In main menu, turn joystick Up or Down to select INFO. Turn joystick Left or Right to enter INFO sub-menu (see diagram 3.29)

EPTZ series	
VERSION:	V0.6.0
PROTOCOL:	AUTO
BAUDRATE:	9600
RS-485-ID:	001
PRESET-CNT:	0000000000
X-CONT:	0000000001
Y-CONT:	0000000004
IRIS+:	RETURN

(diagram 3.29)

- a. **VERSION**: shows firmware version of this speed dome
- b. **PROTOCOL**: shows protocol of this speed dome
- c. **BAUDRATE**: shows baud rate of this speed dome

- d. RS-485-ID: shows RS-485 ID of this speed dome
- e. PRESET-CNT: Preset counter. This counter counts the preset movement, and 1 is counted when the speed dome runs to preset position.
- f. X-CONT: X-axis counter. This counter counts the x axis movement, and 1 is counted when the speed dome pans 360°.
- g. Y-CONT: Y-axis counter. This counter counts the y axis movement, and 1 is counted when the speed dome tilts 180°.
- h. Press **IRIS+** key to return to previous menu.

3.9. EXIT

Exit from the current menu.

4. EPTZ2700/2700I FUNCTION SETUP AND OPERATION

4.1. Manual Control Mode

- **Manual control:** Shift Joystick Up/Down/Left/Right, and turn it Clockwise/Counterclockwise to control speed dome.
Use the control keys which are Zoom, Focus and IRIS function keys on the keyboard to Zoom In/Out, focus N (near)/F (Far), or IRIS +/-.
Note: Zoom In/Out control keys will be disabled when entering to OSD menu mode.
- **HOME Mode:** The camera view will go back to the home position when there is no keyboard operation in a specific time. The home position and the specific time can be set by pressing **Set + Home**.
If you set the time to 0 minute, then the camera will go back to home if there is no keyboard operation in 5 seconds. This is the minimum no action time for HOME mode.
Note: If "HOME" function is enabled, dome will go to home immediately after powering on.

4.2. Auto Pan Mode

- **Two point auto pan:** Press **A.Pan** to enter the auto pan mode, and then the system will ask you to enter the auto pan speed (1~239). Press **Enter** to start auto pan. In order to set the two points, press **Set + A.Pan**, and then enter the dwell time (1~127 seconds) of each point. EPTZ2700 begins to pan from point A to point B clockwise.
- **360° auto pan:** Press **Shift + A.Pan** to enter the 360° auto pan. System will ask you to enter 360° auto pan speed (1~239). The camera will turn 360° automatically, but not tilt.

4.3. Position Setting

- **Focus on a preset position:** Press the number key, and then press **Position** to focus on the number of preset position; or you can press **Position**, then enter the preset position number, and then press **Enter** to focus on the number of preset position.
- **Preset a position:** Shift the Joystick to the position you would like to preset, and then press **Shift + Position**. The system will ask you to enter the preset position number (1~192), and then press **Enter** to save the position. There are up to 192 positions can be preset.

Three specific preset positions can be set as follows:

92 => Set Left Limit Stop (A position)

93 => Set Right Limit Stop (B position)

95 => Enter Menu mode (Use keyboard control keys to control OSD items; **Focus F.** to go downward, **Focus N.** to go upward. **IRIS +** go to previous setting and **IRIS -** to exit).

You can directly go to the following specific preset positions:

33 => Rotation of 180 degree

34 => Go to Home position (if Home Position is set by EVF Keyboard)

96 => Stop Scan

97 => Start running tour

98 => Frame scan (60 degree / step)

Default speed is 32. It can be changed by EVF Keyboard (**Shift + A.Pan** setting speed).

Dwell time: default is 2 sec; It can be changed by EVF Keyboard **Set + A.Pan**

setting dwell time of A pos or B pos.

99 => Auto scan (360 degree)

Default speed is 32. It can be changed by EVF Keyboard (Shift + A.Pan setting speed).

We can even set camera's ICR Day/Night function with RS-485 command via keyboard. How to do this? Press Position + 88 to link to Day mode or Position + 89 to link to Night mode, "ICR AUTO" message will be shown on the right-bottom part of the screen. If OSD Day/Night ICR mode is "AUTO", it cannot be controlled by preset position setting.

- **Set the parameter of a preset position:** Press Set + Position to set the parameter of a preset position. You can set the going-to speed (1~239), dwell time (1~239 seconds), and the title of the position. Shift the joystick Right/Left to change bits, and shift the Joystick Up/Down to change the alphanumeric characteristic. The available alphanumeric characteristics are 0~9, A~Z, &, ?, !, :, ', .., ,, /, -, and a space.
- **Delete a preset position:** Press Clr + Position to delete a preset position. The system will ask you to enter the position number that you would like to delete, and then press Enter.

4.4. Tour Mode

In the tour mode, you can set a tour for viewing. There are 16 tours can be set, and 16 preset positions in a tour.

- **One-way tour Mode:** Press Tour to enter the tour mode. The system will ask you to enter the tour number you would like to run, and starts the tour after pressing Enter.

To preset a tour before running is necessary.

Preset a one-way tour: Press **Set** + **Tour** to preset a one-way tour. The system will ask you to enter preset position numbers (The positions need to be preset). After finish entering all positions, press **Stop** to quit, and then press **Enter** to save the tour.

- **To-and-fro tour mode:** Press **Shift** + **Tour** to run a to-and-fro tour. The system will ask you to enter the tour number you would like to run, and starts the tour after pressing **Enter**. To preset a tour before running it is necessary.

Note 1: The difference between the One-way tour mode and To-and-fro tour mode is that the return modes are different. For example: There is a tour with 3 preset positions 1, 2 and 3. The camera runs 1→2→3→1→2→3 in the One-way tour mode, and 1→2→3→2→1 in the To-and-fro tour mode.

Note 2: You could set a pattern tour. Press **Set** + **Tour**, and input 0, press **Enter**. Sway the joystick to record the entire tour. Press **Stop** to stop recording tour. To view this pattern tour, simply press **Tour**, and input tour number 0.

4.5. Alarm Link to a Position/Tour

EPTZ2700/EPTZ2700I have 4 alarm inputs that can be set to link to a position or a tour when an alarm is triggered.

- **Set an alarm link:**

Press **F1** to set an alarm link. Enter the alarm number, and then press **Enter**.

Switch the Joystick up/down to select a position or a tour, enter a position or tour number, and then press **Enter** to confirm the alarm link setting.

If you set the position number to 99, the dome will do a 360 degree auto scan or AB two point pan if limit is ON. If you set the position number to 98, the dome will do

a frame scan.

➤ **Delete an alarm link:**

Press **Clr** + **F1** to delete a link of alarm to position/tour.

Note 1: After alarm output signal is terminated, the speed dome will resume action or return to its original position.

Note 2: After powering on the speed dome, it will detect alarm status automatically.

4.6. Other Operations

The EPTZ2700/EPTZ2700I can work with a DVR that has PTZ control functions, and a matching protocol. The available control functions depend on different DVRs.

The EPTZ2700/EPTZ2700I can work with a keyboard that has PTZ control functions, and a matching protocol. The available control functions depend on different keyboards.

EverFocus Electronics Corp.

Head Office:

12F, No.79 Sec. 1 Shin-Tai Wu Road,
Hsi-Chih, Taipei, Taiwan
TEL: +886-2-26982334
FAX: +886-2-26982380
www.everfocus.com.tw

USA L.A. Office:

1801 Highland Ave. Unit A
Duarte, CA 91010, U.S.A.
TEL: +1-626-844-8888
FAX: +1-626-844-8838
www.everfocus.com

USA N.Y. Office:

415 Oser Avenue Unit S
Hauppauge, NY 11788
Tel: 631-436-5070
Fax: 631-436-5027
www.everfocus.com

Europe Office:

Albert-Einstein-Strasse 1
D-46446 Emmerich, Germany
TEL: 49-2822-9394-0
www.everfocus.de

China Beijing Office:

Room B-05D-1, KESHI PLAZA ,
Shangdi Information Industry Base,
Haidian District, Beijing China
100085
TEL: +86-10-62973336/37/38/39
FAX: +86-10-62971423
www.everfocus.com.cn

Japan Office:

1809 WBG MARIBU East 18F,
2-6 Nakase.Mihama-ku.
Chiba city 261-7118, Japan
TEL : +81-43-212-8188
FAX : +81-43-297-0081
www.everfocus.com



Your EverFocus product is designed and manufactured with high quality materials and components which can be recycled and reused. This symbol means that electrical and electronic equipment, at their end-of-life, should be disposed of separately from your household waste. Please, dispose of this equipment at your local community waste collection/recycling centre. In the European Union there are separate collection systems for used electrical and electronic product. Please, help us to conserve the environment we live in!

Ihr EverFocus Produkt wurde entwickelt und hergestellt mit qualitativ hochwertigen Materialien und Komponenten, die recycelt und wieder verwendet werden können. Dieses Symbol bedeutet, dass elektrische und elektronische Geräte am Ende ihrer Nutzungsdauer vom Hausmüll getrennt entsorgt werden sollen. Bitte entsorgen Sie dieses Gerät bei Ihrer örtlichen kommunalen Sammelstelle oder im Recycling Centre. Helfen Sie uns bitte, die Umwelt zu erhalten, in der wir leben.



P/N: MW01G02300

Free Manuals Download Website

<http://myh66.com>

<http://usermanuals.us>

<http://www.somanuals.com>

<http://www.4manuals.cc>

<http://www.manual-lib.com>

<http://www.404manual.com>

<http://www.luxmanual.com>

<http://aubethermostatmanual.com>

Golf course search by state

<http://golfingnear.com>

Email search by domain

<http://emailbydomain.com>

Auto manuals search

<http://auto.somanuals.com>

TV manuals search

<http://tv.somanuals.com>