

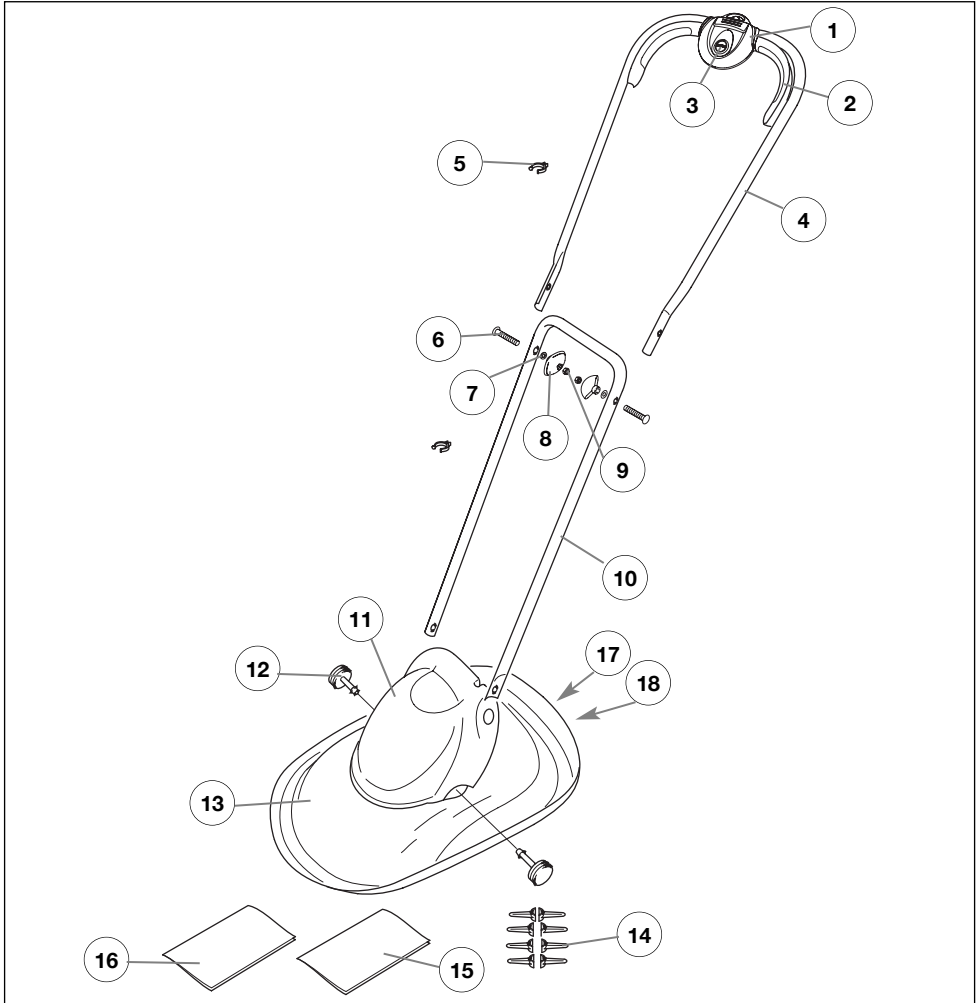

MICRO LITE



GB CONTENTS	DK INDHOLD	SK OBSAH
DE INHALT	ES CONTENIDO	SI VSEBINA
FR TABLE DES MATIÈRES	PT LEGENDA	HR SADRŽAJ
NL INHOUD	IT INDICE CONTENUTI	BA SADRŽAJ
NO INNHOLD	HU TARTALOMJEGYZÉK	CS SADRŽEK
FI SISÄLTÖ	PL ZAWARTOŚĆ KARTONU	
SE INNEHÅLL	CZ POPIS STROJE	

5119627-03

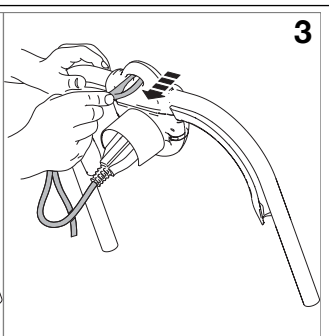
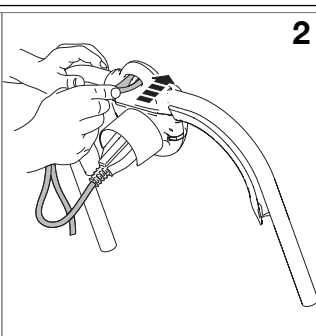
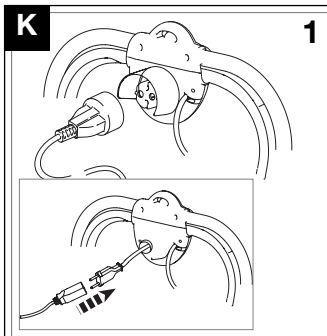
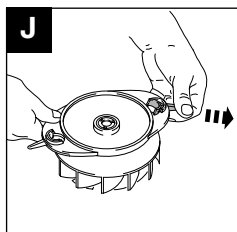
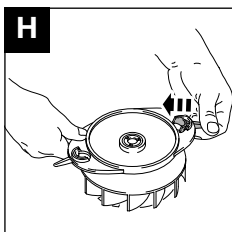
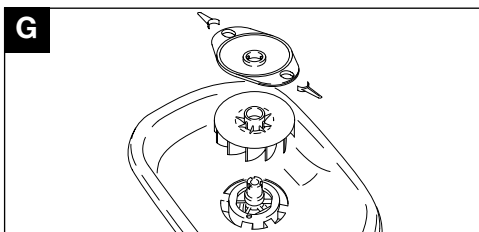
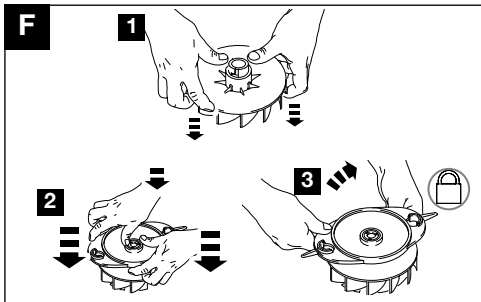
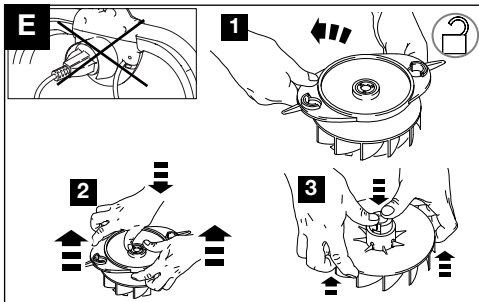
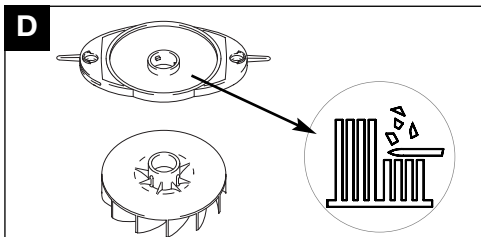
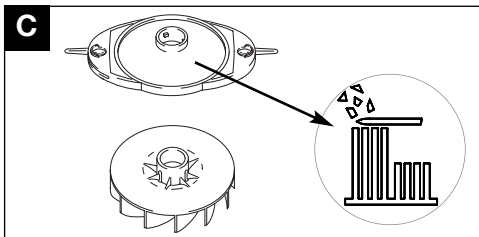
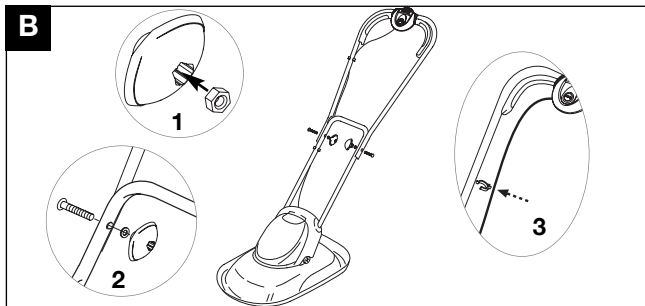
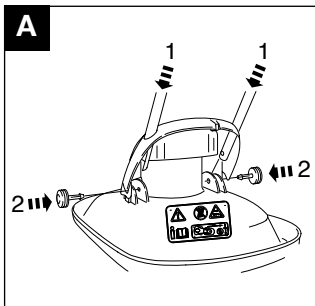

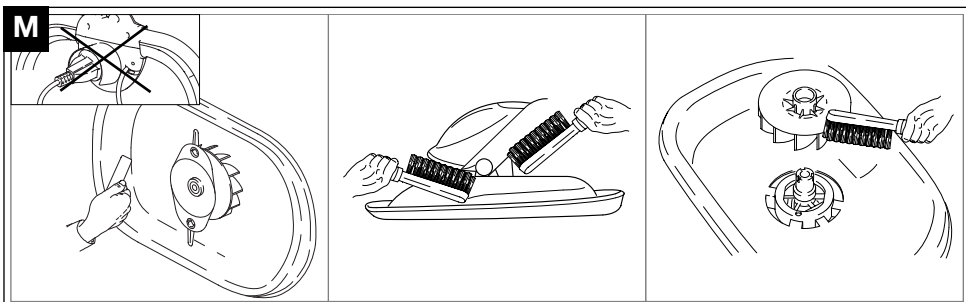
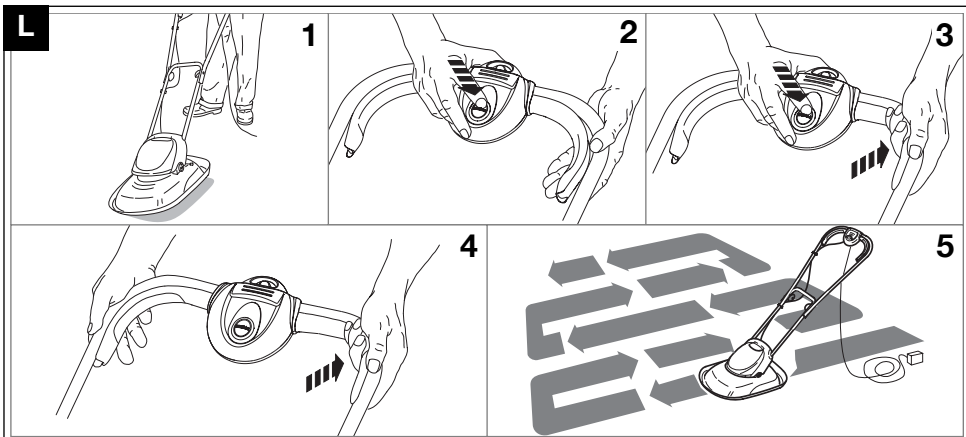

GB **DO NOT** use liquids for cleaning.
DE Zur Reinigung **KEINE** Flüssigkeiten verwenden.
FR **NE PAS** utiliser de produit liquide pour le nettoyage.
NL Voor het reinigen **NOOIT** vloeistoffen gebruiken.
NO Flytende midler **MÅ IKKE** brukes til rengjøring.

FI **ALA** käyttää nesteitä puhdistamiseen.
SE **ANVÄND INTE** vätskor för rengöring.
DK **BRUG IKKE** væske til rengøring.
ES **NO** utilice líquidos para la limpieza.
PT **NÃO** use líquidos para limpar.
IT **NON** usare liquidi per la pulizia.
HU **NE** használjon folyadékokat tisztításra.
PL **NIE** używać płynów do czyszczenia.

CZ K čištění **NEPOUŽÍVEJTE** kapaliny.
SK **NEPOUŽÍVAJTE** na čistenie tekuté materiály.
SI **NE** uporabljajte raznih tekočin za čiščenje.
HR **NEMOJTE** koristiti tekućine za čišćenje.
BA **NEMOJTE** da koristite tečnosti za čišćenje.
CS **НИКАДА** не користите течности за чишћење.

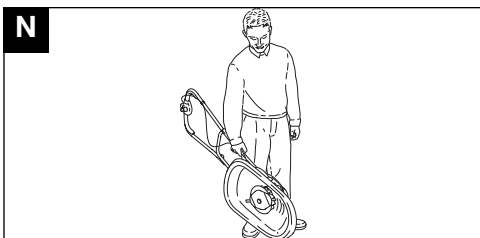

GB For further advice or repairs, contact your local dealer.
DE Für weitere Empfehlungen oder Reparaturarbeiten setzen Sie sich bitte mit Ihrem örtlichen Händler in Verbindung.
FR Pour en savoir plus ou pour toute réparation, contactez votre revendeur local.
NL Voor nadere informatie over reparaties kunt u contact opnemen met uw plaatselijke leverancier.
NO Ta kontakt med din lokale forhandler angående ytterligere opplysninger eller reparasjoner.
FI Tarkempia ohjeita tai tieto korjauksista saat paikalliselta jälleenmyyjältä.

SE För ytterligare rådgivning eller reparationer, kontakta din lokala återförsäljare.
DK For yderligere vejledning eller reparation skal du kontakte din lokale forhandler.
ES Si desea consejos adicionales o reparación, contacte con su distribuidor local.
PT Para orientação adicional ou reparações, contacte o seu agente local.
IT Per ulteriori consigli o riparazioni contattare il rivenditore locale.
HU További tanácsért vagy javítás szükségessége esetén forduljon a helyi forgalmazóhoz.

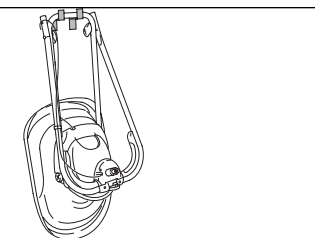

PL W sprawie porad lub napraw skontaktować się z miejscowym przedstawicielem.
CZ O radu nebo opravu požádejte svého místního prodejce.
SK Ďalšie informácie a opravy zabezpečí váš lokálny predajca.
SI Za nadaljnja navodila ali popravila kontaktirajte vasega lokalnega prodajalca.
HR Za daljnje savjete ili popravke, obratite se svom prodavaču.
BA Za daljnje savjete ili popravke, obratite se svom trgovcu.
CS Za další sáveťe o popravkách, obrátíte se lokálním prodávčú.

EC DECLARATION OF CONFORMITY

<p>I, the undersigned M. Bowden of Husqvarna Outdoor Products, Aycliffe Industrial Park, NEWTON AYLCLIFFE, Co. Durham. DL5 6UP. Certify that the Product:-</p> <p>Category.....Electric Lawn Trimmer Marke.....Husqvarna Outdoor Products Conforms to the specifications of Directive 2000/14/EEC</p>	<p>I, the undersigned M. Bowden of Husqvarna Outdoor Products, Aycliffe Industrial Park, NEWTON AYLCLIFFE, Co. Durham. DL5 6UP. Certify that a sample of the above product has been tested using directive 81/1051/EEC as a guide. The maximum A-weighted sound pressure level recorded at operator position under free field semi anechoic chamber conditions was :-</p>	<p>I, the undersigned M. Bowden of Husqvarna Outdoor Products, Aycliffe Industrial Park, NEWTON AYLCLIFFE, Co. Durham. DL5 6UP. Certify that a sample of the above product has been tested using ISO 5349 as a guide. The maximum weighted root mean square value of vibration recorded at operator's hand position was:-</p>
Type of Cutting Device..... Plastic Cutter Identification of Series..... See Product Rating Label Conformity Assessment Procedure..... ANNEX VI Notified Body..... L.T.S., Cleve Road, Leatherhead, Surrey, KT22 7SB England Other Directives..... 98/37/EEC, 89/336/EEC, 73/23/EEC & applicable standards..... EN786, IEC60335-1, IEC60335-2-91, EN61000-3-2, EN61000-3-3, EN55014-1, EN55014-2	Type..... A Width of Cut..... B Speed of Rotation of Cutting Device..... C Guaranteed sound power level..... D Measured Sound Power Level..... E Level..... F Value..... G Weight..... H	

EC KONFORMITÄTSERKLÄRUNG

<p>Ich, der Unterzeichner M. Bowden of Husqvarna Outdoor Products, Aycliffe Industrial Park, NEWTON AYLCLIFFE, Co. Durham. DL5 6UP. Bescheinigung, dass das Produkt:-</p> <p>Kategorie.....Elektrosrasentrimmer Fabrikat.....Husqvarna Outdoor Products die Spezifikationen der Direktive 2000/14/EG erfüllt</p>	<p>Ich, der Unterzeichner M. Bowden, Husqvarna Outdoor Products, Aycliffe Industrial Park, NEWTON AYLCLIFFE, Co. Durham, DL5 6UP, bescheinige hiermit, daß eine Probe des obigen Produkts getestet wurde und dabei Direktive 81/1051/EWG als Richtschnur verwendet wurde. Der maximale A-gewichtete Schalldruckpegel, der an der Bedienersposition unter Freifeld-Halb-schalltot-Kammerbedingungen gemessen wurde, betrug:-</p>	<p>Ich, der Unterzeichner M. Bowden, Husqvarna Outdoor Products, Aycliffe Industrial Park, NEWTON AYLCLIFFE, Co. Durham, DL5 6UP, bescheinige hiermit, daß eine Probe des obigen Produkts getestet wurde und dabei ISO 5349 als Richtschnur verwendet wurde. Der maximale gewichtete Vibrationseffektivwert, der an der Handposition des Bedieners gemessen wurde, betrug:-</p>
Schneidwerktyp..... Kunststoffklingen Identifizierung der reihe..... Siehe Produkttypenschild Konformitätsbestätigungsverfahren..... ANNEX VI Benachrichtigte Behörde..... L.T.S., Cleve Road, Leatherhead, Surrey, KT22 7SB England Andere Direktiven..... 98/37/EEC, 89/336/EEC, 73/23/EEC und Normen..... EN786, IEC60335-1, IEC60335-2-91, EN61000-3-2, EN61000-3-3, EN55014-1, EN55014-2	Typ..... A Schnittbreite..... B Umdrehungsgeschwindigkeit des Schneidwerks..... C Garantierter Geräuschpegel..... D Gemessener Geräuschpegel..... E Höhe..... F Wert..... G Gewicht..... H	

EC DÉCLARATION DE CONFORMITÉ

<p>Je soussigné M. Bowden of Husqvarna Outdoor Products, Aycliffe Industrial Park, NEWTON AYLCLIFFE, Co. Durham. DL5 6UP. Certifie que ce produit:-</p> <p>Categorie.....Coupe-bordure électrique Marque.....Husqvarna Outdoor Products est conforme aux spécifications de la Directive 2000/14/EEC</p>	<p>Je soussigné M. Bowden, Husqvarna Outdoor Products, Aycliffe Industrial Park, NEWTON AYLCLIFFE, Co. Durham, DL5 6UP, Grande-Bretagne, certifie qu'un échantillon du produit ci-dessus a été essayé selon les indications de la directive 81/1051/EEC. Le niveau maximum pondéré de pression acoustique enregistré à la position de l'opérateur en champ libre en chambre demi-sourde était de:-</p>	<p>Je soussigné M. Bowden, Husqvarna Outdoor Products, Aycliffe Industrial Park, NEWTON AYLCLIFFE, Co. Durham, DL5 6UP, Grande-Bretagne, certifie qu'un échantillon du produit ci-dessus a été essayé selon les indications de la norme ISO 5349. La moyenne quadratique pondérée des vibrations enregistrées à la position de la main de l'opérateur était de:-</p>
Type d'outil de coupe..... Raclleur en plastique Identification de la série..... Voir la Plaque d'identification Procédure d'évaluation de la conformité..... ANNEX VI Organisme notifié..... L.T.S., Cleve Road, Leatherhead, Surrey, KT22 7SB England Autres directives..... 98/37/EEC, 89/336/EEC, 73/23/EEC et aux normes..... EN786, IEC60335-1, IEC60335-2-91, EN61000-3-2, EN61000-3-3, EN55014-1, EN55014-2	Type..... A Largeur de coupe..... B Vitesse de rotation de l'outil de coupe..... C Niveau garanti de puissance sonore..... D Niveau mesuré de puissance sonore..... E Niveau..... F Valeur..... G Poids..... H	

EC CONFORMITEITSVERKLARING

<p>Ik, ondergetekende M. Bowden of Husqvarna Outdoor Products, Aycliffe Industrial Park, NEWTON AYLCLIFFE, Co. Durham. DL5 6UP. Verklaaren dat het product:-</p> <p>Categorie.....Elektrische gazmaaier Merk.....Husqvarna Outdoor Products Voldoet aan de specificaties van directief 2000/14/EEC</p>	<p>Ik, ondergetekende M. Bowden, Husqvarna Outdoor Products, Aycliffe Industrial Park, NEWTON AYLCLIFFE, Co. Durham, DL5 6UP, verklaar hierbij dat een proefexemplaar van het bovengenoemde product is getest volgens richtlijn 81/1051/EEC. Het maximale A-belaste geluidsdruk niveau dat is geregistreerd bij de positie van de bediener in een semi geluiddichte ruimte bij vrije veld condities bedraagt:-</p>	<p>Ik, ondergetekende M. Bowden, Husqvarna Outdoor Products, Aycliffe Industrial Park, NEWTON AYLCLIFFE, Co. Durham, DL5 6UP, verklaar hierbij dat een proefexemplaar van het bovengenoemde product is getest volgens ISO 5349 als richtlijn. De maximale belaste effectieve waarde van trilling, geregistreerd bij de positie van de hand van de bediener, bedraagt:-</p>
Type maaier..... Plastic messen Identificatie van serie..... Zie Productlabel Procedure voor het beoordelen van conformiteit..... ANNEX VI Op de hoogte gestelde instantie..... L.T.S., Cleve Road, Leatherhead, Surrey, KT22 7SB England Andere directieven..... 98/37/EEC, 89/336/EEC, 73/23/EEC en aan de volgende normen..... EN786, IEC60335-1, IEC60335-2-91, EN61000-3-2, EN61000-3-3, EN55014-1, EN55014-2	Type..... A Maaibreedte..... B Toerental maaier..... C Gegarandeerd geluidsvermogen..... D Gemeten geluidsvermogen..... E Niveau..... F Waarde..... G Gewicht..... H	

EC KONFORMITETSERKLÆRING

<p>Undertegnede, M. Bowden of Husqvarna Outdoor Products, Aycliffe Industrial Park, NEWTON AYLCLIFFE, Co. Durham. DL5 6UP. Attesterer at produktet:-</p> <p>Kategori.....Elektrisk plenklipper Merke.....Husqvarna Outdoor Products Svarer til spesifikasjonene i Direktiv 2000/14/EEC</p>	<p>Undertegnede, M. Bowden, Husqvarna Outdoor Products, Aycliffe Industrial Park, NEWTON AYLCLIFFE, Co. Durham, DL5 6UP bevinner at en prøve av ovennevnte produkt er testet, med direktiv 81/1051/EEC som rettleiding. Maksimum A-belastede lydtrykknivå, registrert ved brukernes plassering, under frittt felt halvveis ekofritt kammerforhold, var :-</p>	<p>Undertegnede, M. Bowden, Husqvarna Outdoor Products, Aycliffe Industrial Park, NEWTON AYLCLIFFE, Co. Durham, DL5 6UP bevinner at en prøve av ovennevnte produkt er testet, med direktiv ISO 5349 som rettleiding. Maksimum belastede effektivverdi av vibrering, registrert ved plasseringen av brukernes hånd, var:-</p>
Type Klippeinretning..... Plastkniver avstandsstykker Serieidentifikasjon..... Se Produktets Klassifiseringssettikett Prosedyre for konformitetsvurdering..... ANNEX VI Etat det er meldt fra til..... L.T.S., Cleve Road, Leatherhead, Surrey, KT22 7SB England Andre direktiver..... 98/37/EEC, 89/336/EEC, 73/23/EEC og standarder..... EN786, IEC60335-1, IEC60335-2-91, EN61000-3-2, EN61000-3-3, EN55014-1, EN55014-2	Type..... A Klippebredde..... B Klippeinretningens rotasjons hastighet..... C Garantert lyd kraftnivå..... D Mått lyd kraftnivå..... E Nivå..... F Verdi..... G Vekt..... H	

EC VAATIMUSTENMUSTENMUKAISUUSVAKUUTUS

Minä allekirjoittanut M. Bowden of Husqvarna Outdoor Products, Aycliffe Industrial Park, NEWTON AYCLIFFE , Co. Durham. DL5 6UP. Varmistaa, että laite:- Luokitus..... Sähkökäyttöinen nurmikonsistijä Merkki..... Husqvarna Outdoor Products Vastaa direktiivin 2000/14/ETY vaatimuksia.	Minä allekirjoittanut M. Bowden, Husqvarna Outdoor Products, Aycliffe Industrial Park, NEWTON AYCLIFFE , Co. Durham DL5 6UP, vahvistan, että yllä mainitun tuotteen näytekappale on tarkastettu käyttäen EU-direktiiviä 81/1051/ETY viitteenä. Suurin A-painotettu käyttäjän kohdalla mitattu äänenpaineen taso puolioktavoimassa huoneessa käyttäjän tasolla oli seuraava:-	Minä allekirjoittanut M. Bowden, Husqvarna Outdoor Products, Aycliffe Industrial Park, NEWTON AYCLIFFE , Co. Durham DL5 6UP, vahvistan, että yllä mainitun tuotteen näytekappale on tarkastettu käyttäen ISO 5349 -standardia viitteenä. Suurin painotettu käsivarstärinä käyttäjän käden kohdalla oli seuraava:-
Leikkauslaitteen tyyppi..... Muovi terät Sarjan Tunnus..... Katso Tuotteen Arvokilpää Yhdenmukaisuusarviointi..... ANNEX VI Tiedotusosaupuil..... I.T.S., Cleeve Road, Leatherhead, Surrey, KT22 7SB England Muut direktiivit..... 98/37/EEC, 89/336/EEC, 73/23/EEC sekä standardit..... EN786, IEC60335-1, IEC60335-2-91, EN61000-3-2, EN61000-3-3, EN55014-1, EN55014-2	Typpi..... A Leikkausleveys..... B Leikkauslaitteen pyörimisnopeus..... C Taattu luotettava tehontaso..... D Mitattu luotettava tehontaso..... E Taso F Arvo..... G Paino..... H	

EC FÖRSÄKRAN OM ÖVERENSSTÄMMESE

Jag, undertecknad M. Bowden of Husqvarna Outdoor Products, Aycliffe Industrial Park, NEWTON AYCLIFFE , Co. Durham. DL5 6UP. Intyga att produkten:- Kategori..... Elektrisk kantklippare Tillverkare..... Husqvarna Outdoor Products överensstämmer med specifikationerna i direktiv 2000/14/EEC	Jag, undertecknad M. Bowden, Husqvarna Outdoor Products, Aycliffe Industrial Park, NEWTON AYCLIFFE , Co Durham, DL5 6UP, betygar att ett exemplar av ovan nämnda produkt har testats med bestämmelse 81/1051/EEC som riktlinje. Det maximala A-vägda ljudtrycknivån som uppmättes vid körplatsen under förhållanden i en trifalls halvt ekofri kammare var:-	Jag, undertecknad M. Bowden, Husqvarna Outdoor Products, Aycliffe Industrial Park, NEWTON AYCLIFFE , Co Durham, DL5 6UP, betygar att ett exemplar av ovan nämnda produkt har testats med bestämmelse ISO 5349 som riktlinje. Det maximala vägd kvadratiska medelvärdet för vibration som uppmätts vid förarens handläge var:-
Typ av klippanordning..... Skärblad av plast Identifiering av serie..... Se Produktidentifieringsetikett Metod för bedömning av överensstämmelse..... ANNEX VI Notifierat organ..... I.T.S., Cleeve Road, Leatherhead, Surrey, KT22 7SB England Andra direktiv..... 98/37/EEC, 89/336/EEC, 73/23/EEC samt följande standarder..... EN786, IEC60335-1, IEC60335-2-91, EN61000-3-2, EN61000-3-3, EN55014-1, EN55014-2	Typ..... A Klippbredd..... B Varvtal på klippanordning..... C Garanterat ljudnivå på motor..... D Uppmätt ljudnivå på motor..... E Nivå..... F Vikt..... H	

EC ÖVERENSSTÄMMESESERKLÄRING

Undertegnede, M. Bowden of Husqvarna Outdoor Products, Aycliffe Industrial Park, NEWTON AYCLIFFE , Co. Durham. DL5 6UP. Kontroller, at produkt:- Kategori..... Elektrisk græsstrimmer Fabrikant..... Husqvarna Outdoor Products over holder specifikationerne i direktivet 2000/14/EOF	Undertegnede, M. Bowden, Husqvarna Outdoor Products, Aycliffe Industrial Park, NEWTON AYCLIFFE , Co. Durham DL5 6UP, attesterer herved, at en prøve af ovenstående produkt er blevet testet, idet direktiv 81/1051/EEC er blevet anvendt som vejledning. Det maksimale A-vægtede lydtrykniveau, som er blevet målt på brugerpositionen i et trifaltshalvdødt rum var:-	Undertegnede, M. Bowden, Husqvarna Outdoor Products, Aycliffe Industrial Park, NEWTON AYCLIFFE , Co. Durham DL5 6UP, attesterer herved, at en prøve af ovenstående produkt er blevet testet, idet ISO 5349 er blevet benyttet som vejledning. Den maksimale vægtede effektværdi for vibration som er blevet registreret ved brugerens håndposition var:-
Type klippehed..... Plastskærebåde Identifikation af serie..... Se Produktmærkate Fremgangsmåde til vurdering af overensstemmelse..... ANNEX VI Underrettet organ..... I.T.S., Cleeve Road, Leatherhead, Surrey, KT22 7SB England Andre direktiver..... 98/37/EEC, 89/336/EEC, 73/23/EEC og standarderne..... EN786, IEC60335-1, IEC60335-2-91, EN61000-3-2, EN61000-3-3, EN55014-1, EN55014-2	Type..... A Klippebredde..... B Klippemedens rotationshastighed..... C Garanteret lydtrykniveau..... D Målt lydtrykniveau..... E Niveau..... F Værdi..... G Vægt H	

EC DECLARACION DE CONFORMIDAD

El abajo firmante M. Bowden of Husqvarna Outdoor Products, Aycliffe Industrial Park, NEWTON AYCLIFFE , Co. Durham. DL5 6UP. Certifico que el producto:- Categoría..... Cortadora de césped eléctrica Marca..... Husqvarna Outdoor Products Está conforme con las especificaciones de la Directiva 2000/14/EEC	El abajo firmante M. Bowden, Husqvarna Outdoor Products, Aycliffe Industrial Park, NEWTON AYCLIFFE , Co. Durham DL5 6UP. Certifico que ha sido probada una muestra del producto anteriormente mencionado utilizando la directiva 81/1051/EEC como guía. El máximo nivel de presión de sonido ponderado A registrado en la posición del operario bajo condiciones de cámara anecoica de semi campo fue de:-	El abajo firmante M. Bowden, Husqvarna Outdoor Products, Aycliffe Industrial Park, NEWTON AYCLIFFE , Co. Durham DL5 6UP. Certifico que ha sido probada una muestra del producto anteriormente mencionado utilizando como guía ISO 5349. El valor máximo ponderado de la media de la raíz cuadrada de la vibración registrada en la posición de la mano del operario fue de:-
Tipo de dispositivo de corte..... Cortadoras plásticas Identificación de la serie..... Ver Etiqueta de Identificación Del Producto Procedimiento de evaluación de conformidad..... ANNEX VI Organismo notificado..... I.T.S., Cleeve Road, Leatherhead, Surrey, KT22 7SB England Otras directivas..... 98/37/EEC, 89/336/EEC, 73/23/EEC y con las normativas..... EN786, IEC60335-1, IEC60335-2-91, EN61000-3-2, EN61000-3-3, EN55014-1, EN55014-2	Tipo..... A Anchura de corte..... B Velocidad de rotación del dispositivo de corte..... C Nivel de potencia sonora garantizado..... D Nivel de potencia sonora medido..... E Nivel..... F Valor..... G Peso..... H	

EC DECLARAÇÃO DE CONFORMIDADE

Eu, abaixo assinado, M. Bowden of Husqvarna Outdoor Products, Aycliffe Industrial Park, NEWTON AYCLIFFE , Co. Durham. DL5 6UP. Certifico que o produto:- Categoria..... Máquina de Cortar Relva (Trimmer) Eléctrica Marca..... Husqvarna Outdoor Products Está em conformidade com a Directiva 2000/14/CEE	Eu, abaixo assinado, M. Bowden, Husqvarna Outdoor Products, Aycliffe Industrial Park, NEWTON AYCLIFFE , Co. Durham, DL5 6UP. Certifico que uma amostra do produto acima foi testada tendo como guia a directiva 81/1051/CEE. O valor máximo da média pesada A do nível de pressão do som registado na posição do operador, em condições de câmara semi-anecoica de campo livre foi:-	Eu, abaixo assinado, M. Bowden, Husqvarna Outdoor Products, Aycliffe Industrial Park, NEWTON AYCLIFFE , Co. Durham, DL5 6UP. Certifico que uma amostra do produto acima foi testada tendo como guia a norma ISO 5349. O valor máximo da média quadrática pesada da vibração registado na posição da mão do operador foi:-
Tipo de Dispositivo de Corte..... Cortadores de plástico Identificação da série..... Consulte a Etiqueta de Especificações do Produto Procedimento de Avaliação de Conformidade..... ANNEX VI Órgão Notificado..... I.T.S., Cleeve Road, Leatherhead, Surrey, KT22 7SB England Outras Directivas..... 98/37/EEC, 89/336/EEC, 73/23/EEC e com as normativas..... EN786, IEC60335-1, IEC60335-2-91, EN61000-3-2, EN61000-3-3, EN55014-1, EN55014-2	Tipo A Largura de Corte..... B Velocidade de Rotação do Dispositivo de Corte..... C Nível de Intensidade de Som Garantido..... D Nível de Intensidade de Som Medido..... E Nível..... F Valor..... G Peso..... H	

EC DICHIARAZIONE DI CONFORMITÀ

Il sottoscritto M. Bowden of Husqvarna Outdoor Products, Aycliffe Industrial Park, NEWTON AYLCLIFFE , Co. Durham. DL5 6UP. Certificare che il prodotto:- Categoria:..... Tagliabordi elettrico Marca:..... Husqvarna Outdoor Products è conforme alle normative della Direttiva 2000/14/CEE	Il sottoscritto, M. Bowden, Husqvarna Outdoor Products, Aycliffe Industrial Park, NEWTON AYLCLIFFE , Co. Durham, DL5 6UP, dichiara che un campione del suddetto prodotto è stato testato in base alla direttiva 81/1051/CEE. Il livello massimo di pressione sonora categoria A rilevato in corrispondenza della posizione di guida in condizioni di camera semianecoica in campo libero era di:-	Il sottoscritto, M. Bowden, Husqvarna Outdoor Products, Aycliffe Industrial Park, NEWTON AYLCLIFFE , Co. Durham, DL5 6UP, dichiara che un campione del suddetto prodotto è stato testato in base alla direttiva ISO 5349. Il valore ponderale massimo di vibrazione sonora a efficacia rilevato in corrispondenza delle mani dell'operatore era di:-
Tipo di lama..... Lame di plastica Identificazione serie..... Vedi Etichetta Dati Prodotto Procedura di valutazione della conformità..... ANNEX VI Ente notificato..... I.T.S., Cleeve Road, Leatherhead, Surrey, KT22 7SB England Altre direttive..... 98/37/EEC, 89/336/EEC, 73/23/EEC e alle normative..... EN786, IEC60335-1, IEC60335-2-91, EN61000-3-2, EN61000-3-3, EN55014-1, EN55014-2	Tipo..... A Larghezza di taglio..... B Velocità di rotazione della lama..... C Livello sonoro misurato..... D Livello sonoro misurato..... E Livello..... F Valore..... G Peso..... H	

EC MEGFELELŐSÉGI TANUSÍTVÁNY

Alulírott, M. Bowden of Husqvarna Outdoor Products, Aycliffe Industrial Park, NEWTON AYLCLIFFE , Co. Durham. DL5 6UP. Alulírott, tanusítom, hogy a termék:- Kategória:..... Elektromos trimmelő Gyártmány..... Husqvarna Outdoor Products megfelel a 2000/14/EEC direktívák specifikációinak	Alulírott, M. Bowden, Husqvarna Outdoor Products, Aycliffe Industrial Park, NEWTON AYLCLIFFE , Co. Durham. DL5 6UP. Igazolom, hogy a fenti termékintá a 81/1051/EEC szabályok szerinti tesztelték. A szabad hangtéri, félig visszahangmentes kamrai körülmények közötti, kezelt helyzetben rögzített maximálisan atmoszferikusan-nehezített hangnyomásszint:	Alulírott, M. Bowden, Husqvarna Outdoor Products, Aycliffe Industrial Park, NEWTON AYLCLIFFE , Co. Durham. DL5 6UP. Igazolom, hogy a fenti termékintá az ISO 5349 szabályzat szerint tesztelték. A kezelő kézhelyzetében rögzített vibráció maximálisan súlyozott effektív bemeneti zajhőmérséklete:-
Vágóéltípus..... Műanyag vágóé Szeria azonosítása..... Lásd a Termékminősítő Cédulát Termékjegyzelőség..... ANNEX VI Értesített testület..... I.T.S., Cleeve Road, Leatherhead, Surrey, KT22 7SB England Egyéb direktívák..... 98/37/EEC, 89/336/EEC, 73/23/EEC valamint az..... EN786, IEC60335-1, IEC60335-2-91, EN61000-3-2, EN61000-3-3, EN55014-1, EN55014-2	Tipus..... A Vágószélesség..... B Vágóé forgásebessége..... C Garantiált hangerőszint..... D Mért hangerőszint..... E Szint..... F Érték..... G Súly..... H	

EC DEKLARACJA ZGODNOŚCI

Ja, niżej podpisany M. Bowden of Husqvarna Outdoor Products, Aycliffe Industrial Park, NEWTON AYLCLIFFE , Co. Durham. DL5 6UP. Zaświadczam się że produkt:- Kategorie..... Elektryczna kosiarzka do trawników Wykonanie..... Husqvarna Outdoor Products Odpowiada wymaganiom technicznym Dyrektywy Europejskiej Wspólnoty Gospodarczej (EWG) nr 2000/14/EEC	Ja, niżej podpisany M. Bowden, Husqvarna Outdoor Products, Aycliffe Industrial Park, NEWTON AYLCLIFFE , Co. Durham DL5 6UP Anglia, oświadczam, że próbka powyższego wyrobu została przebadana stosując dyrektywę 81/1051/EEC jako wzór. Maksymalny poziom ciśnienia akustycznego, ważonego średnio A, przy pozycji operatora w warunkach częściowo bezochowej komory akustycznej pochłaniającej był:-	Ja, niżej podpisany M. Bowden, Husqvarna Outdoor Products, Aycliffe Industrial Park, NEWTON AYLCLIFFE , Co. Durham DL5 6UP Anglia, oświadczam, że próbka powyższego wyrobu została przebadana stosując ISO 5349 jako wzór. Maksymalna ważona wartość średnia kwadratuwa vibracji zapisana w pozycji ręki operatora była:-
Typ Urządzenia Tnącego..... Plastykowe noże Identyfikacja serii..... Patrz Tabliczka Znamionowa Wyrobu Procedura Oceny Zgodności..... ANNEX VI Organ Rejestrujący..... I.T.S., Cleeve Road, Leatherhead, Surrey, KT22 7SB England Inne Dyrektywy..... 98/37/EEC, 89/336/EEC, 73/23/EEC oraz norm..... EN786, IEC60335-1, IEC60335-2-91, EN61000-3-2, EN61000-3-3, EN55014-1, EN55014-2	Typ..... A Szerokość koszenia..... B Prędkość Obrotowa Urządzenia Tnącego..... C Gwarantowany Poziom Mocy Akustycznej..... D Mierzony Poziom Mocy Akustycznej..... E Poziom..... F Wartość..... G Odważnik..... H	

ES PROHLÁŠENÍ O SHODĚ

Já, níže podepsaný M. Bowden, Husqvarna Outdoor Products, Aycliffe Industrial Park, NEWTON AYLCLIFFE , Co. Durham. DL5 6UP. Potvrzují, že tento výrobek:- Kategorie..... Elektrická sekačka na trávu Značka..... Husqvarna Outdoor Products Vyhovuje specifikacím Směrnice 2000/14/EEC	Já, níže podepsaný M. Bowden, Husqvarna Outdoor Products, Aycliffe Industrial Park, NEWTON AYLCLIFFE , Co. Durham, DL5 6UP, prohlašuji, že vzorek shora uvedeného výrobku byl odtkoušen v souladu se Směrnici 81/1051/EEC. Maximální A-vážená úroveň tlaku zvuku zaznamenaná v místě obsluhy v podmínkách volného pole zvukové izolované komory, byla:-	Já, níže podepsaný M. Bowden, Husqvarna Outdoor Products, Aycliffe Industrial Park, NEWTON AYLCLIFFE , Co. Durham, DL5 6UP, prohlašuji, že shora uvedený výrobek byl odtkoušen v souladu s normou ISO 5349. Maximální vážený průměr hodnoty vibrací, které byly zaznamenány v místě umístění ruky obsluhy, byla:-
Typ začío nástroje..... Plastové začío nože Identifikace série..... Viz Výrobní štítek Postup při posuzování shody..... ANNEX VI Autorizovaná osoba..... I.T.S., Cleeve Road, Leatherhead, Surrey, KT22 7SB England Použité Směrnice..... 98/37/EEC, 89/336/EEC, 73/23/EEC a normy..... EN786, IEC60335-1, IEC60335-2-91, EN61000-3-2, EN61000-3-3, EN55014-1, EN55014-2	Typ..... A Šírka sekání..... B Počet otáček začío nástroje..... C Garantovaná hladina akustického výkonu..... D Naměřená hladina akustického výkonu..... E Úroveň..... F Hmotná..... G Hmotnost..... H	

EC PREHLÁŠENIE O PRAVNEJ SPOSOBILOSTI TOVARU

Ja, dolupodpisany, M. Bowden of Husqvarna Outdoor Products, Aycliffe Industrial Park, NEWTON AYLCLIFFE , Co. Durham. DL5 6UP. Potvrdzujem, že výrobok :- Kategória..... Elektrická kosačka trávy Výroba..... Husqvarna Outdoor Products Vyhovuje špecifikáciám uvedeným v Norme 2000/14/EEC	Ja, dopodpisany, M. Bowden, Husqvarna Outdoor Products, Aycliffe Industrial Park, v meste NEWTON AYLCLIFFE , Co. Durham, DL5 6UP, týmto potvrdzujem, že vzorka hore menovaného výrobku bola otestovaná v súlade s predpisom 81/1051/EEC. Pri maximálnom zaťažení úroveň tlaku zvuku nameraná u operatora za podmienok voľného polového pôsobenia polo-anechoického priestoru bola:-	Ja, dopodpisany, M. Bowden, Husqvarna Outdoor Products Park, Aycliffe Industrial Park, v meste NEWTON AYLCLIFFE , Co. Durham, DL5 6UP, týmto potvrdzujem, že vzorka hore menovaného výrobku bola otestovaná v súlade s predpisom ISO 5349. Pri maximálnom zaťažení základný priemer druhej mocniny vibrácie nameraný v operej ruke bol:-
Typ rezného telesa..... Plastové nože Identifikácia série..... Vid Štítok Parametrov Výrobku Postup určenia právnej spôsobilosti tovaru..... ANNEX VI Informované orgány..... I.T.S., Cleeve Road, Leatherhead, Surrey, KT22 7SB England Ďalšie nariadenia..... 98/37/EEC, 89/336/EEC, 73/23/EEC a normám..... EN786, IEC60335-1, IEC60335-2-91, EN61000-3-2, EN61000-3-3, EN55014-1, EN55014-2	Typ..... A Šírka skosu..... B Rýchlosť rotácie rezného telesa..... C Garantovaný stupeň sily zvuku..... D Nameryany stupeň sily zvuku..... E Úroveň..... F Hodnota..... G Váha..... H	

EC IZJAVA PROIZVAJALCA O SKLADNOSTI PROIZVODA Z STANDARDI

Spodaj podpisani M. Bowden of Husqvarna Outdoor Products, Aycliffe Industrial Park, NEWTON AYCLIFFE , Co. Durham. DL5 6UP. Potrjujemo, da je proizvod:- kategorija..... električni obrezovalnik za robne travni površini blagovna znanaka..... Husqvarna Outdoor Products v skladu z določbami Direktive 2000/14/EEC	Spodaj podpisani M. Bowden, Husqvarna Outdoor Products, Aycliffe Industrial Park, NEWTON AYCLIFFE , Co. Durham DL5 6UP potrjujem, da je bil primerek zgornjega proizvoda testiran glede na pravilnik 81/1051/EEC. Maximalni nivo pritiska zvoka A-jakosti, ki je bil zabeležen na poziciji upravnika v pogojih prostega polja semi-anoakoične komore je bil:-	Spodaj podpisani M. Bowden, Husqvarna Outdoor Products, Aycliffe Industrial Park, NEWTON AYCLIFFE , Co. Durham. DL5 6UP potrjujem, da je bil primerek zgornjega proizvoda testiran glede na pravilnik ISO 5349. Maksimalna povprečna zmerjena vrednost korena na kvadrat za vibriranje, zabeležena na poziciji upravnikev je bila roke je bila:-
Vrsta naprave za rezanje..... Plastična rezila Identifikacija serije..... Glejte Etiketno Označbo Proizvoda Postopek ugotavljanja skladnosti..... ANNEX VI Obveščeno telo..... I.T.S., Cleeve Road, Leatherhead, Surrey, KT22 7SB England Druge direktive..... 98/37/EEC, 89/336/EEC, 73/23/EEC in po standardih..... EN786, IEC60335-1, IEC60335-2-91, EN61000-3-2, EN61000-3-3, EN55014-1, EN55014-2	Tip..... A Širina reza..... B Hitrost rotacije naprave za rezanje..... C Zajamčen nivo hrupa..... D Izmerjen nivo hrupa..... E Nivo..... F Vrednost..... G Obtežitvi..... H	

IZJAVA O SUKLADNOSTI - Evropska Zajednica (EC)

Ja, niže potpisani M. Bowden iz Husqvarna Outdoor Products, Aycliffe Industrial Park, NEWTON AYCLIFFE , Co. Durham. DL5 6UP. potrjujem da je proizvod: Kategorija..... Električni obrezač za travu Proizvod..... Husqvarna Outdoor Products u skladnosti sa specifikacijama Direktive 2000/14/EEC	Ja, niže potpisani M. Bowden iz Husqvarna Outdoor Products, Aycliffe Industrial Park, NEWTON AYCLIFFE , Co. Durham. DL5 6UP. potrjujem da je primjerak gore navedenog proizvoda bio testiran prema smjernicama direktive 81/1051/EEC. Maksimalni A-ponderirani pritisak zvuka zabilježen na mjestu operatora pod uvjetima slobodnog (akustičkog) polja u polugluhoj komori bila je:	Ja, niže potpisani M. Bowden iz Husqvarna Outdoor Products, Aycliffe Industrial Park, NEWTON AYCLIFFE , Co. Durham. DL5 6UP. potrjujem da je primjerak gore navedenog proizvoda bio testiran prema smjernicama ISO 5349. Maksimalna ponderirana srednja kvadratna vrijednost vibracije zabilježena na mjestu ruke operatera bila je:
Vrsta uređaja za rezanje..... Plastični rezač Identifikacija serija..... Vidi etiketu s ocjenom proizvoda Postupak za ocjenu skladnosti..... ANNEX VI Obavještena ustanova..... I.T.S., Cleeve Road, Leatherhead, Surrey, KT22 7SB England Druge direktive..... 98/37/EEC, 89/336/EEC, 73/23/EEC i primjenivi standardi..... EN786, IEC60335-1, IEC60335-2-91, EN61000-3-2, EN61000-3-3, EN55014-1, EN55014-2	Vrsta..... A Širina reza..... B Brzina rotacije uređaja za rezanje..... C Garantirana razina snage zvuka..... D Izmjerena razina snage zvuka..... E Razina..... F Vrijednost..... G Težina..... H	

IZJAVA O SUKLADNOSTI - Evropska Zajednica (EC)

Ja, niže potpisani M. Bowden iz Husqvarna Outdoor Products, Aycliffe Industrial Park, NEWTON AYCLIFFE , Co. Durham. DL5 6UP. potrjujem da je proizvod: Kategorija..... Električni obrezač za travu Proizvod..... Husqvarna Outdoor Products u skladnosti sa specifikacijama Direktive 2000/14/EEC	Ja, niže potpisani M. Bowden iz Husqvarna Outdoor Products, Aycliffe Industrial Park, NEWTON AYCLIFFE , Co. Durham. DL5 6UP. potrjujem da je primjerak gore navedenog produkta bio testiran prema smjernicama direktive 81/1051/EEC. Maksimalni A-ponderirani pritisak zvuka zabilježen na lokaciji operatera pod uvjetima slobodnog (akustičkog) polja u polugluhoj komori bila je:	Ja, niže potpisani M. Bowden iz Husqvarna Outdoor Products, Aycliffe Industrial Park, NEWTON AYCLIFFE , Co. Durham. DL5 6UP. potrjujem da je primjerak gore navedenog produkta bio testiran prema smjernicama ISO 5349. Maksimalna ponderirana srednja kvadratna vrijednost vibracije zabilježena na poziciji ruke operatera bila je:
Vrsta uređaja za rezanje..... Plastični rezač Identifikacija serija..... Vidi etiketu s ocjenom produkta Postupak za ocjenu skladnosti..... ANNEX VI Obavještena ustanova..... I.T.S., Cleeve Road, Leatherhead, Surrey, KT22 7SB England Druge direktive..... 98/37/EEC, 89/336/EEC, 73/23/EEC i primjenivi standardi..... EN786, IEC60335-1, IEC60335-2-91, EN61000-3-2, EN61000-3-3, EN55014-1, EN55014-2	Vrsta..... A Širina reza..... B Brzina rotacije uređaja za rezanje..... C Garantirani nivo snage zvuka..... D Izmjereni nivo snage zvuka..... E Nivo..... F Vrijednost..... G Težina..... H	

EУ ДЕКЛАРАЦИЈА О УСКЛАЂЕНОСТИ

Ja, dole potpisani M. Bowden, iz firme Husqvarna Outdoor Products, Aycliffe Industrial Park, NEWTON AYCLIFFE , Co. Durham. DL5 6UP. Garantujem da je proizvod:- Kategorija..... Električni trimmer za travnjake Marka..... Husqvarna Outdoor Products u skladu sa specifikacijama Direktive 2000/14/EEC	Ja, dole potpisani M. Bowden, iz firme Husqvarna Outdoor Products, Aycliffe Industrial Park, NEWTON AYCLIFFE , Co. Durham. DL5 6UP. Garantujem da je uzorak gore navedenog proizvoda ispitivan u saglasnosti sa direktivom 81/1051/EEC. Maksimalni A-ponderisani nivo zvučnog pritiska zabeležen na poziciji rukovođa pod uslovima slobodnog polja u polugluvoj komori bio je:-	Ja, dole potpisani M. Bowden, iz firme Husqvarna Outdoor Products, Aycliffe Industrial Park, NEWTON AYCLIFFE , Co. Durham. DL5 6UP. Garantujem da je uzorak gore navedenog proizvoda ispitivan u saglasnosti sa standardom ISO 5349. Maksimalna ponderisana srednja kvadratna vrednost vibracija zabeleženih na poziciji ruku rukovođa bila je:-
Vrsta sečiva..... Plastično sečivo Oznaka serije..... Vidi nalepnicu na proizvodu Procedura za ispitivanje usaglašenosti..... ANNEX VI Obavešteno telo..... I.T.S., Cleeve Road, Leatherhead, Surrey, KT22 7SB England Druge direktive..... 98/37/EEC, 89/336/EEC, 73/23/EEC i primenivi standardi..... EN786, IEC60335-1, IEC60335-2-91, EN61000-3-2, EN61000-3-3, EN55014-1, EN55014-2	Vrsta..... A Širina reza..... B Brzina rotacije sečiva..... C Garantovani nivo jačine zvuka..... D Izmereni nivo jačine zvuka..... E Nivo..... F Vrednost..... G Težina..... H	

A	MLite 28
B	28 cm
C	7,250 RPM
D	96 dB (A)
E	96 dB (A)
F	84.1 dB(A)
G	1.21 m/s²
H	4.5 kg



Newton Aycliffe, 08/02/2006
 M. Bowden,
 Research & Development Director

PL - INSTRUKCJA OBSŁUGI

Podkaszarka
Micro Lite
Wydanie I, 2006
SWW 0673-91

DANE TECHNICZNE

Napięcie zasilania	230 V, 50 Hz
Moc silnika	1100 W
Klasa izolacji	II
Ciążar	4,5 kg
Szerokość koszenia	28 cm
Wysokość koszenia	2 (10 - 30 mm)

UWAGA !

Znaki bezpieczeństwa na urządzeniu muszą być widoczne i utrzymywane w czystości. W razie ich uszkodzenia lub utraty należy je wymienić lub uzupełnić w autoryzowanym punkcie serwisowym.

UWAGA !

Podkaszarka przeznaczona jest wyłącznie do zastosowań przydomowych i nie może być używana w innym celu niż podkaszanie trawy i krawędziowanie brzegów trawnika.

Firma Flymo zastrzega sobie możliwość zmiany parametrów technicznych w ramach ciągłego unowocześniania urządzeń.

Druki gwarancji wydawane są przy zakupie urządzenia. Przepisy gwarancyjne określone są na Karcie Gwarancyjnej.

CZ - Technická data

Motor:	elektrický
Napětí:	230 V, 50 Hz
Příkon motoru:	1100W
Šířka sekání:	28cm
Výška sečení	2 (10-30)mm
Hmotnost:	4.5 kg

Free Manuals Download Website

<http://myh66.com>

<http://usermanuals.us>

<http://www.somanuals.com>

<http://www.4manuals.cc>

<http://www.manual-lib.com>

<http://www.404manual.com>

<http://www.luxmanual.com>

<http://aubethermostatmanual.com>

Golf course search by state

<http://golfingnear.com>

Email search by domain

<http://emailbydomain.com>

Auto manuals search

<http://auto.somanuals.com>

TV manuals search

<http://tv.somanuals.com>