

# Flymo

 Electrolux

## Venturer 370 RE420 RE420c

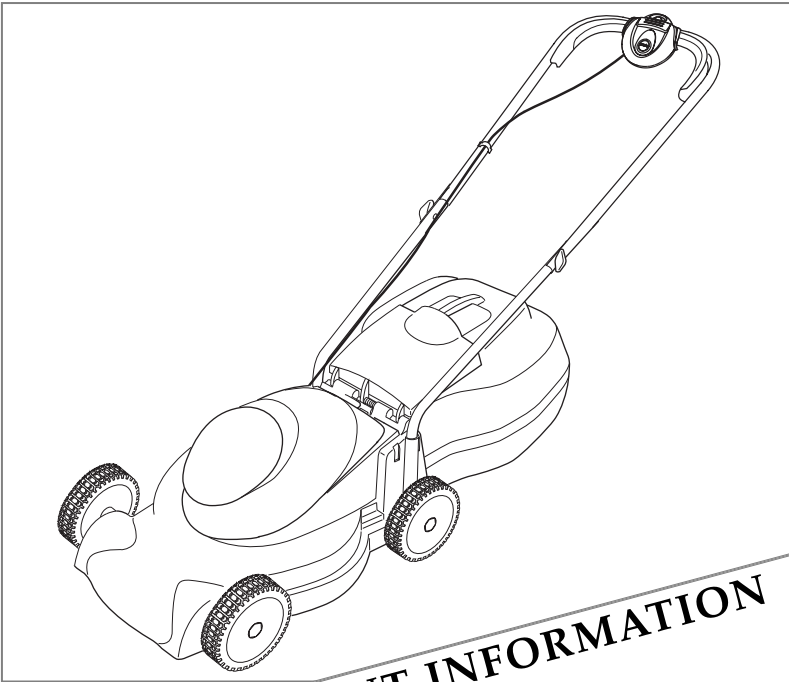

**IMPORTANT INFORMATION**  
Read before use  
& retain for future reference



For all customer enquiries or for replacement parts, contact:-

 01325 300303

 [www.flymo.com](http://www.flymo.com)

*Ventu*  
*RE420*

[eop.customer.services@electrolux.co.uk](mailto:eop.customer.services@electrolux.co.uk)

## Safety



**Please Note:- This manual covers various products. Please read the user instructions carefully to fully identify, assemble and use the features that apply to your product.**

If not used properly this lawnmower can be dangerous! This lawnmower can cause serious injury to the operator and others, the warnings and safety instructions must be followed to ensure reasonable safety and efficiency in using this lawnmower. The operator is responsible for following the warning and safety instructions in this manual and on the lawnmower. Never use the mower unless the grassbox or guards provided by the manufacturer are in the correct position.

### Explanation of Symbols on your Product



Warning



Read the user instructions carefully to make sure you understand all the controls and what they do.



Always keep the lawnmower on the ground when mowing. Tilting or lifting the lawnmower may cause stones to be thrown out

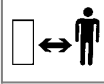

Keep bystanders away. Do not mow whilst people especially children or pets are in the mowing area



Switch off! Remove plug from mains before adjusting, cleaning or if cable is entangled or damaged. Keep the cable away from the blade.



Beware of severing toes or hands. Do not put hands or feet near a rotating blade.



Blade continues to rotate after the machine is switched off. Wait until all machine components have completely stopped before touching them.



Do not mow in the rain or leave the lawnmower outdoors while raining

### General

- Never allow children or people unfamiliar with these instructions to use the mower. Local regulations may restrict the age of the operator.
- Only use the lawnmower in the manner and for the functions described in these instructions.
- Never operate the lawnmower when you are tired, ill or under the influence of alcohol, drugs or medicine.
- The operator or user is responsible for accidents or hazards occurring to other people or their property.

### Electrical

- The British Standards Institute recommend the use of a Residual Current Device (R.C.D.) with a tripping current of not more than 30mA. Even with a R.C.D. installed 100% safety cannot be guaranteed and safe working practice must be followed at all times. Check your R.C.D. every time you use it.
- Before use, examine cable for damage, replace it if there are signs of damage or ageing.
- Do not use the lawnmower if the electric cables are damaged or worn.

- Immediately disconnect from the mains electricity supply if the cable is cut, or the insulation is damaged. Do not touch the electric cable until the electrical supply has been disconnected. Do not repair a cut or damaged cable. Replace it with a new one.
- Your extension cable must be uncoiled, coiled cables can overheat and reduce the efficiency of your mower.
- Keep cable away from lawnmower, always work away from the power point mowing up and down, never in circles.
- Do not pull cable around sharp objects.
- Always switch off at the mains before disconnecting any plug, cable connector or extension cable.
- Switch off, remove plug from mains and examine electric supply cable for damage or ageing **before** winding cable for storage. Do not repair a damaged cable, replace it with a new one. Use only Flymo replacement cable.
- Always wind cable carefully, avoiding kinking.
- Never pull on the cable to disconnect any of the plugs.
- Never carry the product by the cable.
- Use only on AC mains supply voltage shown on the product rating label.
- Our products are double insulated to EN60335. Under no circumstances should an earth be connected to any part of the product.

### Preparation

- Do not mow barefoot or in open sandals. Always wear suitable clothing, gloves, and stout shoes.
- Make sure the lawn is clear of sticks, stones, bones, wire and debris; they could be thrown by the blade.
- Before using the machine and after any impact, check for signs of wear or damage and repair as necessary.
- Replace worn or damaged blades together with their fixings in sets to preserve balance.

### Use

- Use the lawnmower only in daylight or good artificial light.
- Avoid operating your lawnmower in wet grass, where feasible.
- Take care in wet grass, you may lose your footing.
- On slopes, be extra careful of your footing and wear non-slip footwear.
- Mow across the face of slopes, never up and down.
- Exercise extreme caution when changing direction on slopes. Walk never run.
- Mowing on banks and slopes can be dangerous. Do not mow on **banks** or **steep** slopes.
- Do not walk backwards when mowing, you could trip.
- Never cut grass by pulling the mower towards you.
- Switch off before pushing the mower over surfaces other than grass.
- Never operate the lawnmower with damaged guards or without guards in place.
- Keep hands and feet away from the cutting means at all times and especially when switching on the motor.
- Do not tilt lawnmower when the motor is running, except when starting and stopping. In this case, do not tilt more than absolutely necessary and lift only the part which is away from the operator. Always ensure that both hands are in the operating position before returning the appliance to the ground.
- Do not put hands near the grass discharge chute.
- Never pick up or carry a mower when it is operating or still connected to the mains supply.

16. Remove the plug from the mains :

- before leaving the mower unattended for any period;
- before clearing a blockage;
- before checking, cleaning or working on the appliance;
- if you hit an object. Do not use your lawnmower until you are sure that the entire lawnmower is in a safe operating condition.;
- if the lawnmower starts to vibrate abnormally. Check immediately. Excessive vibration can cause injury.

## CABLES

### IMPORTANT

- Use only 1.00mm<sup>2</sup> size cable up to 40 metres length maximum.

### Maximum rating :

1.00mm<sup>2</sup> size cable, 10 amps 250 volts AC.

### • YOUR LAWNMOWER IS SUPPLIED WITH AN ELECTRIC MAINS CABLE FITTED WITH A FEMALE CONNECTOR.

1. Flymo Mains Cables and Extension Cables are available from your local Electrolux Outdoor Products Approved Service Centre.
2. Do not wire an extension cable directly to your product yourself. Please contact your local Electrolux Outdoor Products Approved Service Centre for further information on the connectors and kits available.
3. Only use extension cables specifically designed for outdoor use.

## CONNECTORS

### IMPORTANT

- Flymo connectors are suitable for use with 2 core cable only. Under no circumstances should these connectors be used for earthed products.
- All Flymo connectors and cables are of splashproof construction. They are not waterproof and must not be left outside permanently nor should they be submerged or immersed in water. Do not let cable lay or trail through pools of water or splashed with water from hose pipes.

## Maintenance and storage

1. Keep all nuts, bolts and screws tight to be sure the lawnmower is in safe working condition.
2. Check the grassbox frequently for wear or deterioration.
3. Replace worn or damaged parts for safety.
4. Only use the replacement blade, blade bolt, spacer and impeller specified for this product.
5. Be careful during adjustment of the lawnmower to prevent entrapment of the fingers between moving blades and fixed parts of the machine.

## MAINS PLUG REPLACEMENT

### IMPORTANT

- **If the plug supplied is cut off it should be destroyed. There is an electric shock hazard if a cut off plug is inserted into a 13 amp socket.**
1. **No earth required.** Flymo products are double insulated to EN60335 and under no circumstances should an earth be connected to any part of the product.
  2. **Ensure the mains voltage suits your product**
  3. **IMPORTANT!**

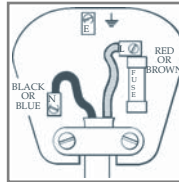

The wires in the mains lead are coloured in accordance with the following code:

BLUE - NEUTRAL  
BROWN - LIVE

The wire which is coloured BLUE must be connected to the Terminal which is marked with the letter 'N' or coloured BLACK. The wire which is coloured BROWN must be connected to the Terminal which is marked with the letter 'L' or coloured RED.

4. It is important that the outer sheath is clamped correctly into the 3-pin plug.
5. If in doubt consult your local Service Repairer or qualified electrician before the machine is used.
6. **A 13 Amp fuse must be fitted to the Mains Plug.**
7. The normal plug fuse and household fuse only protect the electrical equipment and are not a safeguard against electrocution.

## Assembly Instructions

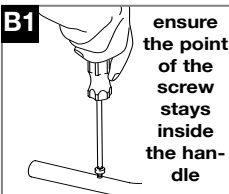
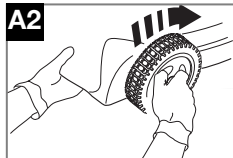
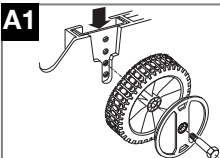

ensure the point of the screw stays inside the handle

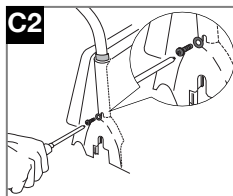
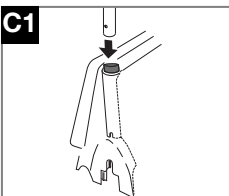
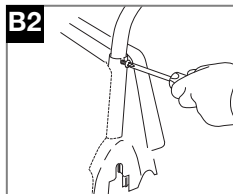

### Wheel Assembly (if not already fitted) (A1, A2)

1. Select one of the holes in the mounting plate and note it as the other wheels will need to be adjusted to the same position. (A1)
2. Locate the fixing bolt through hole in the hub cap, wheel and selected hole in mounting plate.
3. Turn the wheel hub in a clockwise direction until the wheel assembly is securely located to the deck. (A2)

### Lower Handle Assembly - Ventura 370 (B1, B2)

1. Locate 2 screws into the holes in the handles.
2. Using a pozidrive screwdriver, secure the screws into the lower handles, ensuring the point of the screw stays inside the handle. (B1)
3. Insert lower handles, with screws attached, into the deck and fully tighten screws. (B2)

**Note: The screw will form its own thread**

### Lower Handle Assembly - RE420/420c (C1, C2)

1. If your product has Cutting Height with levers (see **Cutting Height Adjustment**), ensure the lever is at the Highest Cut Height before following steps 2 & 3.
2. Insert lower handles into deck as shown in Fig C1.
3. Push each handle firmly down until it is located securely into the deck (C2).
4. Insert screw through the washer and into holes using a pozidrive screwdriver and tighten fully into deck as shown in Fig C2.

## Upper Handle Assembly

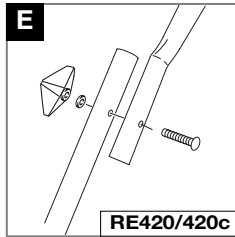
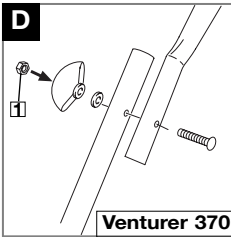

### Fitting Upper Handles to Lower Handles (D & E)

1. Ensure the upper handle is located correctly with the lock-off button on the switchbox uppermost
2. Ensure the upper handle and the lower handle are aligned correctly.
3. Insert the nut into the handle knob. (if applicable) (**D1**)
4. Fit the bolts, washers and handle knobs.
5. Fit the cable to the handles with the clips provided. Make sure the cable is not trapped between the handles.

## Grassbox Assembly

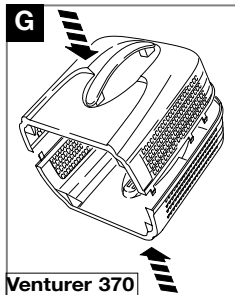
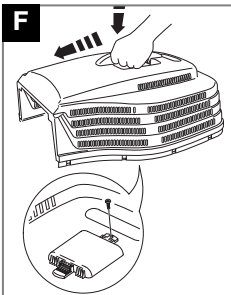

### Grassbox Assembly - Venturer 370.

1. Insert the grassbox handle into the top of one of the grassbox halves. Press firmly down and forward until the handle clicks into position (**F**)
2. Turn the grassbox half over and insert screw into hole (**as illustrated in fig F**) and tighten fully.
3. Locate grassbox upper into grassbox lower (**G**). Align clips, ensure all clips are correctly located.
4. Clip the two halves together.
5. Ensure all clips are securely connected.

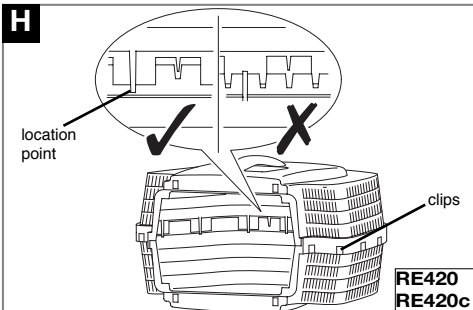

### Grassbox Assembly - RE420/RE420c

1. Insert the grassbox handle into the top of one of the grassbox halves. Press firmly down and forward until the handle clicks into position (**F**)
2. Turn the grassbox half over and insert screw into hole (**as illustrated in fig F**) and tighten fully.
3. Position the two grassbox halves together and press each location point (**H**) into position **without** fully connecting the clips. When the location points are matched correctly firmly press the grassbox together until all clips are securely connected. (**J**)

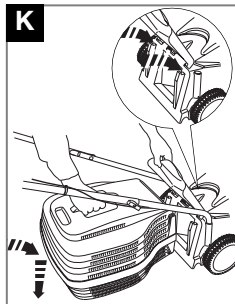
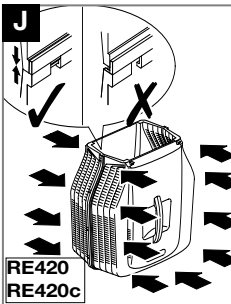

### Fitting the Grassbox

1. To attach the grassbox to your lawnmower, lift the safety flap (**K**) and make sure the discharge chute is clean and free from debris.
2. Locate fully assembled grassbox onto 2 location points at the rear of the deck. (**K**)
3. Locate safety flap onto the top of the grassbox. Ensure the grassbox is securely located.
  - Removal is the reverse procedure.
  - **Please Note:- Ensure no gap remains between the safety flap and the grassbox.**
  - **Where grass collection is not required you can use the lawnmower without the grassbox. Ensure the safety flap is fully closed.**

## Cutting Height Adjustment

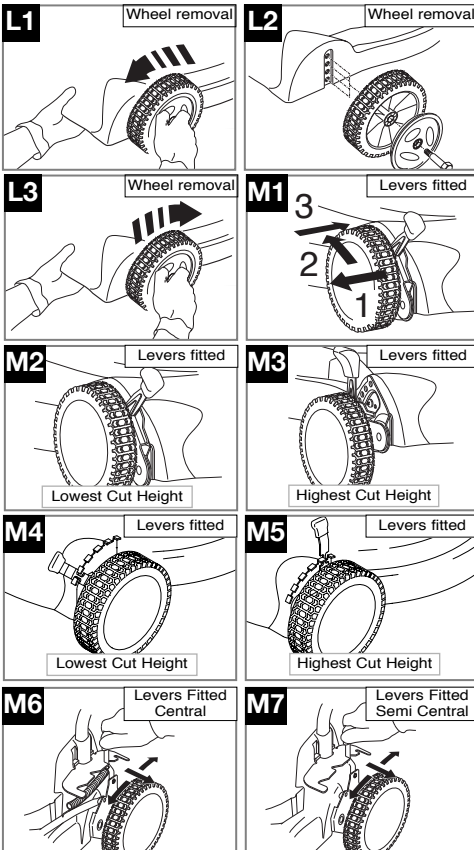

### Cutting Height with removal of wheels (L1, L2, L3)

If your lawnmower has wheel hubs as illustrated in Fig L1, the height of cut is adjusted by following steps L1 - L3.

1. Remove the wheel by turning the wheel hub in an anticlockwise direction (L1) and relocate in new hole (L2) turning the wheel hub in a clockwise direction to tighten (L3). Repeat for other wheels adjusting to the same position.

### WARNING:

If you have levers fitted to the wheel do not attempt to unscrew the wheel hub. Use the levers to alter the height of cut.

### Cutting Height with Levers (M1 - M7)

1. If you have Height of Cut levers (Figs. M), the height of cut is altered by pulling the adjustment lever away from the location slots and moving to the selected position (M1).
2. If your product is fitted with more than one lever then these must be adjusted to the same position (Figs. M2 & M7).

## Starting and Stopping

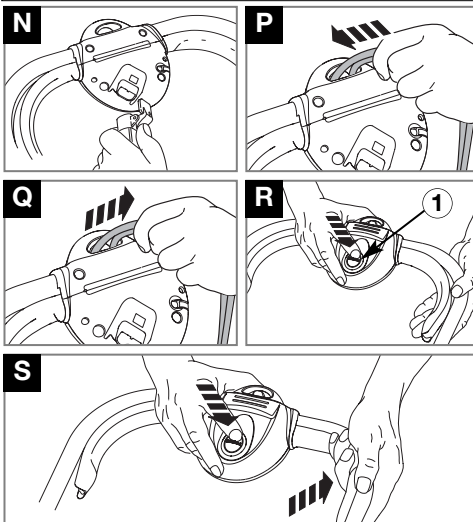

### To Start your Lawnmower

1. Connect female extension cable connector to the back of the switchbox. (N)
2. Form loop in mains cable and push the loop through the slot as illustrated in picture (P)
3. To secure, position loop over the hook and pull the cable back through the slot as illustrated in picture (Q).
4. Connect plug to mains and switch on.
5. Tilt the handle downwards to slightly raise the front of the lawnmower and to reduce the risk of lawn damage whilst starting.

### The switchbox is provided with a lock-off button (R1) to prevent accidental starting.

6. Press and hold the lock-off button (R) on the switchbox, then squeeze one of the Start/Stop levers towards the upper handle (S).
7. Continue to squeeze the start/stop lever towards the upper handle and release the lock-off button.
8. Lower the lawnmower to its proper operating position and commence mowing.

• **NOTE** There are two start/stop levers fitted. Either one can be used for starting the lawnmower.

• **IMPORTANT** Do not use the start/stop levers intermittently

### To Stop Your Lawnmower.

1. Release the pressure of the Start/Stop lever.

## How to Mow

1. Start mowing the edge of the lawn nearest to the power point so that the cable is laid out on the lawn you have already cut (**T**).
2. Mow twice a week in the growing season, your lawn will suffer if more than one third of its length is cut at one time and this may also result in poor collection.

- **Please Note**

- **Do not overload your Lawnmower**

- When mowing in long thick grass a first cut with the cutting height adjusted to its highest setting, (**see Cutting Height Adjustment**), will help reduce motor overload and will help prevent damage to your lawnmower.

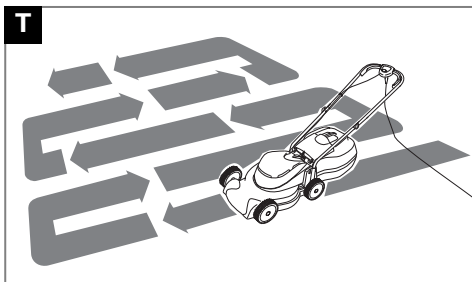

## Cutting System Maintenance

### Removing the Blade and Fan

1. To remove the blade bolt, hold the fan firmly and with the spanner provided loosen the blade bolt by turning it anti-clockwise (**U**).
2. Remove the blade bolt, blade, and fan.
3. Inspect for damage and clean as necessary.

### Fitting the Blade and Fan

1. Ensure the fan is located correctly (**V**).
2. Fit the blade to the fan with the sharp edges pointing away from the fan.
3. Re-assemble blade bolt through blade and fan.
4. Hold the fan firmly and tighten blade bolt firmly with a spanner. Do not over tighten.

**Always handle the blade with care - sharp edges could cause injury. USE GLOVES. Renew your metal blade after 50 hours mowing or 2 years whichever is the sooner - regardless of condition. If the blade is cracked or damaged replace it with a new one. Never use a blade bolt if the insulated head is damaged cracked or missing.**

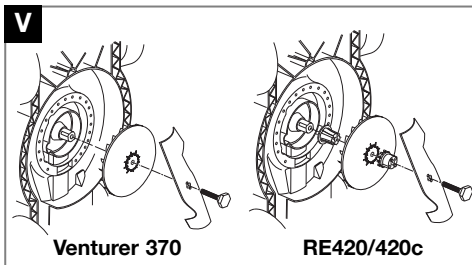
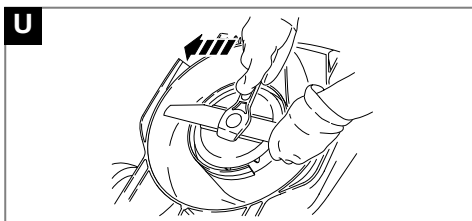

## Caring for your Lawnmower

### Cleaning (W, X, Y)

- **USE GLOVES**

1. Remove grass from under the deck with a brush (**W**).
2. Using a soft brush (**X**) remove grass clippings from all air intakes, the discharge chute and the grass box.
3. Remove the blade to gain access to the fan and clean with a soft brush (**Y**).
4. Wipe over the surface of your lawnmower with a dry cloth.

- **IMPORTANT**

- Never use water for cleaning your lawnmower. Do not clean with chemicals, including petrol, or solvents - some can destroy critical plastic parts.

### At the End of the Mowing Season

1. Replace blade, bolts, nuts or screws, if necessary.
2. Clean your lawnmower thoroughly.
3. Ask your local Service Centre to clean the air filter thoroughly and carry out any service or repairs required.
4. Make sure that the electric cable is coiled properly.

### Storing your Lawnmower

Store in a dry place where your lawnmower is protected from damage.

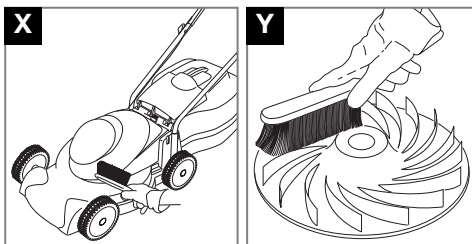
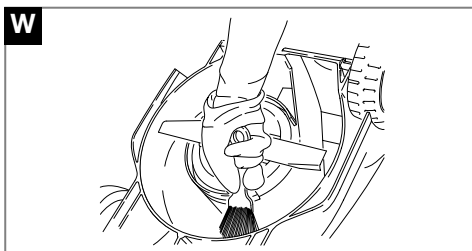

## Fault Finding Hints

### Fails to Operate

1. Is the correct Starting procedure being followed?  
See 'To Start your Lawnmower'.
2. Is the Power Turned On?
3. Check the fuse in the plug, if blown replace.
4. Fuse continues to blow?  
**Immediately disconnect from the mains electricity supply and consult your local approved Electrolux Outdoor Products Service Centre.**

### Poor Grass Collection

1. Disconnect from the mains electricity supply.
2. Clean the outside of the air intakes, the discharge chute and the underside of the deck.
3. Clean the outside of the Air Filters. (Ask your local service centre to clean your air filter thoroughly).
4. Clean Fan Blades.

5. **If poor collection persists. Immediately disconnect from the mains electricity supply and consult your local approved Electrolux Outdoor Products Service Centre.**

### Excessive Vibration

1. Disconnect from the mains electricity supply.
2. Check that the blade is fitted correctly?
3. If the blade is damaged or worn, replace it with a new one.
4. If vibration persists, turn the blade through 180° by first loosening the blade bolt, turning the blade and re-tightening the blade bolt.
5. If vibration persists?  
**Immediately disconnect from the mains electricity supply and consult your local approved Electrolux Outdoor Products Service Centre.**

## Guarantee & Guarantee Policy

If any part is found to be defective due to faulty manufacture within two years of original purchase, Electrolux Outdoor Products, through its Authorised Service Repairers will effect the repair or replacement to the customer free of charge providing:

- (a) The fault is reported directly to the Authorised Repairer.
  - (b) Proof of purchase is provided.
  - (c) The fault is not caused by misuse, neglect or faulty adjustment by the user.
  - (d) The failure has not occurred through fair wear and tear.
  - (e) The machine has not been serviced or repaired, taken apart or tampered with by any person not authorised by Electrolux Outdoor Products.
  - (f) The machine has not been used for hire.
  - (g) The machine is owned by the original purchaser.
  - (h) The machine has not been used commercially.
- \* This guarantee is additional to, and in no way diminishes the customers statutory rights.

Failures due to the following are not covered, therefore it is important that you read the instructions contained in this Operator's Manual and understand how to operate and maintain your machine:

### Failures not covered by guarantee

- \* Replacing worn or damaged blades
- \* Failures as a result of not reporting an initial fault.
- \* Failures as a result of sudden impact.
- \* Failures as a result of not using the product in accordance with the instructions and recommendations contained in this Operator's Manual.
- \* Machines used for hire are not covered by this guarantee.
- \* The following items listed are considered as wearing parts and their life is dependent on regular maintenance and are, therefore not normally subject to a valid warranty claim: Blades, Electric Mains cable.
- \* **Caution!**  
Electrolux Outdoor Products does not accept liability under the warranty for defects caused in whole or part, directly or indirectly by the fitting of replacement parts or additional parts that are not either manufactured or approved by Electrolux Outdoor Products, or by the machine having been modified in any way

## Environmental Information

Electrolux Outdoor Products are manufactured under an Environmental Management System (ISO 14001) using, where practical, components manufactured in the most environmentally responsible manner, according to company procedures, and with the potential for recycling at the end of the products' life.

- Packaging is recyclable and plastic components have been labelled (where practical) for categorised recycling.
- Awareness of the environment must be considered when disposing of 'end-of-life' product.
- If necessary, contact your local authority for disposal information.

The symbol  on the product or on its packaging indicates that this product may not be treated as household waste. Instead it shall be handed over to the applicable collection point for the recycling of electrical and electronic equipment.

By ensuring this product is disposed of correctly, you will help prevent potential negative consequences for the environment and human health, which could otherwise be caused by inappropriate waste handling of this product.

For more detailed information about recycling of this product, please contact your local council office, your household waste disposal service or the shop where you purchased the product.







## Free Manuals Download Website

<http://myh66.com>

<http://usermanuals.us>

<http://www.somanuals.com>

<http://www.4manuals.cc>

<http://www.manual-lib.com>

<http://www.404manual.com>

<http://www.luxmanual.com>

<http://aubethermostatmanual.com>

Golf course search by state

<http://golfingnear.com>

Email search by domain

<http://emailbydomain.com>

Auto manuals search

<http://auto.somanuals.com>

TV manuals search

<http://tv.somanuals.com>