

Flymo®

CORDLESS

Multi-Trim CT250^{plus}

INSTRUCTION MANUAL

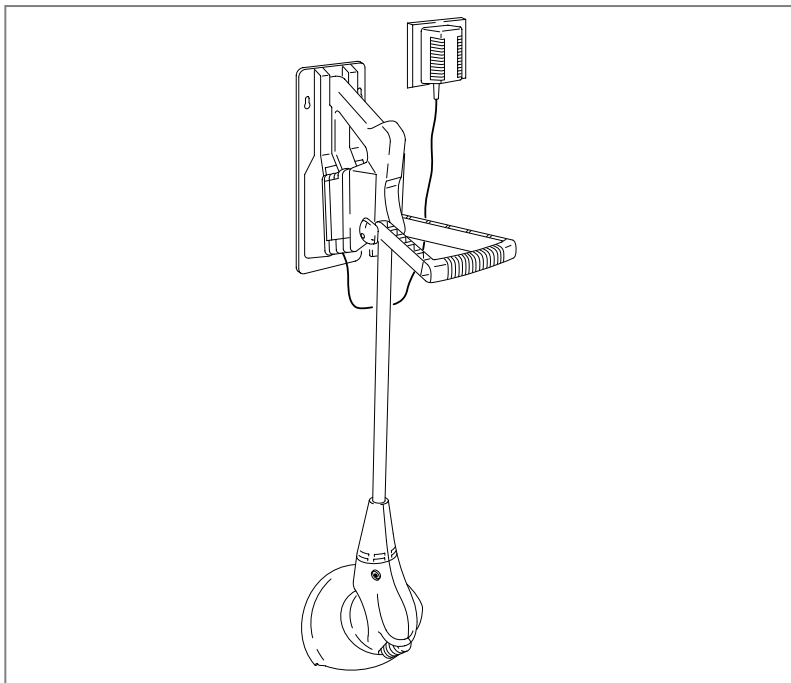

IMPORTANT INFORMATION

Read before use

& retain for future reference

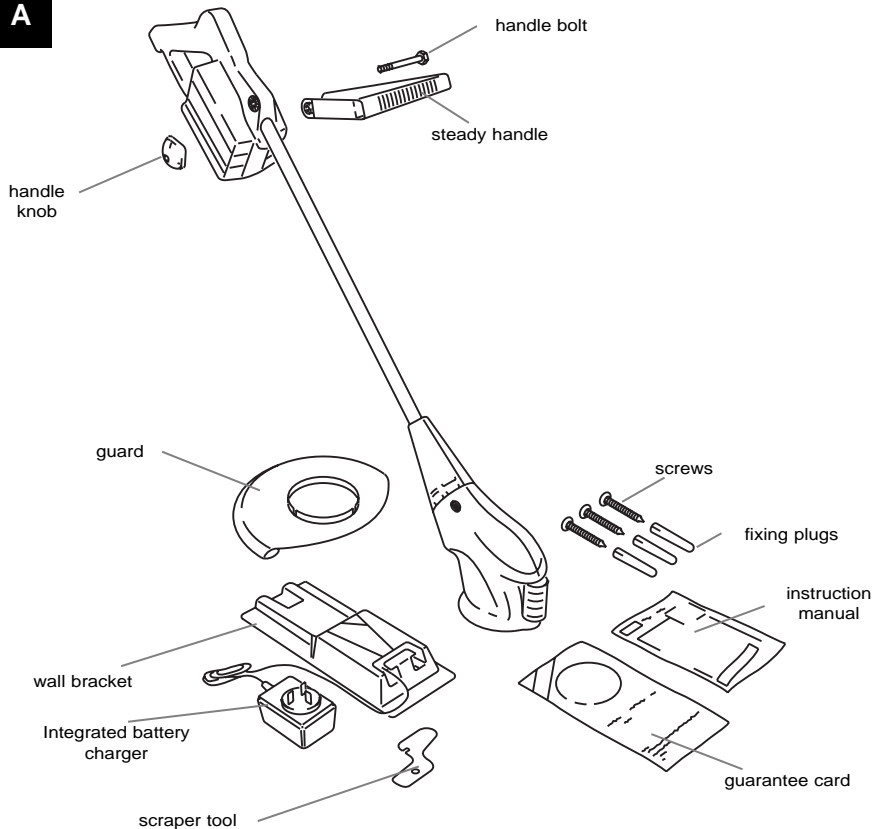

Carton Contents

A

LIST OF INSTRUCTION MANUAL CONTENTS

CONTENTS	(1)
SAFETY	(2-4)
ASSEMBLY & ADJUSTMENT	(5-7)
USE	(8)
MAINTENANCE	(9-10)
GUARANTEE	(11)
CERTIFICATE OF CONFORMITY & INSIDE BACK COVER	(12)

IMPORTANT !

Please check the contents of the carton are correct **BEFORE** assembling your new Flymo product.

IF ANY PARTS ARE MISSING CONTACT:-

Flymo/Partner Customer Service Department
 direct Telephone : 01325 300303
 Fax : 01325 318193



If not used properly this trimmer can be dangerous! This trimmer can cause serious injury to the operator and others, the warnings and safety instructions must be followed to ensure reasonable safety and efficiency in using this trimmer. The operator is responsible for following the warning and safety instructions in this manual and on the trimmer.

Explanation of Symbols on the Cordless Trimmer



Warning



Read the user instructions carefully

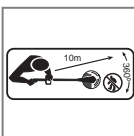

Keep others, including children, pets and bystanders outside the 10 metre hazard zone. Stop the trimmer immediately if you are approached.



The use of eye protection is recommended to protect against objects thrown by the nylon line.

Warning

The cutting line continues to rotate after the machine has been switched off.

General

1. Never allow children or people unfamiliar with these instructions to use the trimmer. Local regulations may restrict the age of the operator.
2. Only use the trimmer in the manner and for the functions described in these instructions.
3. Never operate the trimmer when you are tired, ill or under the influence of alcohol, drugs or medicine.
4. The operator or user is responsible for accidents or hazards occurring to other people or their property.

Battery

Cordless Battery Powered Products require special care.

1. AVOID ACCIDENTAL STARTING
KEEP HANDS AND FINGERS AWAY FROM THE SWITCH LEVER WHILE CARRYING THE TRIMMER.
2. Always charge the product indoors and store in a cool dry place - out of the reach of children.
3. Use only the charger provided with your unit. Use of any other charger could permanently damage the battery and the trimmer.
4. Use the charger with standard domestic household electrical outlets only.
5. Do not abuse the charger or charger cord.
6. Do not use the charger if the charger or charger cord is damaged.
7. Use the charger indoors only.
8. Do not use the charger outdoors.
9. Store and charge this unit in a cool, dry well ventilated location and out of the reach of children.
10. Do not charge the battery or use the unit in an explosive or corrosive environment. Avoid areas where flammable liquids or gases are present to avoid creating a fire or explosion.

11. Do not attempt to repair the unit including the battery. Nylon line replacement and cleaning the unit are the only items suitable for user maintenance.
12. Do not insert any object into the motor area. Keep free of debris to avoid overheating.
13. Do not incinerate or mutilate the battery. Batteries contain hazardous chemicals. Dispose of properly.

Preparation

1. Do not trim barefoot or in open sandals. Always wear suitable clothing, gloves, and stout shoes.
2. Inspect the trimmer before each use, especially the parts of the cutting head.
3. Inspect the area to be cut before each use. Remove all objects such as stones, broken glass, nails, wire, string etc, which can be thrown or become entangled in the trimmer head.
4. Check that the cutting head, spool and cap are fitted correctly.

Use

1. Use the trimmer only in daylight or good artificial light.
2. Avoid operating your trimmer in wet grass, where feasible.
3. Take care in wet grass, you may lose your footing.
4. On slopes, be extra careful of your footing and wear non-slip footwear.
5. Do not walk backwards when trimming, you could trip. Walk, never run.
6. Switch off before pushing the trimmer over surfaces other than grass.
7. Never operate the trimmer with damaged guards or without guards in place.
8. Never fit metal cutting elements.
9. Avoid possible injuries to feet and hands from rotating cutting line. Always start the trimmer carefully with feet and hands well away from the cutting head.
10. Keep cutting head below waist level
11. Do not lean over the trimmer guard whilst trimming or edging - objects may be thrown by the cutting line.
12. Beware of cut-off pieces of nylon line ejected during use.

Maintenance and storage

1. Keep all nuts, bolts and screws tight to be sure the trimmer is in safe working condition.
2. Replace worn or damaged parts for safety.
3. Only use the replacement cutting line specified for this product.
4. Only use replacement parts and accessories recommended by Flymo/Partner.
5. To avoid the risk of injury keep fingers and hands clear of the line cutter on the leading edge of the guard.
6. Clean unit with a dry cloth. Never use metal objects to clean the unit.
7. Inspect and maintain the trimmer regularly. Any repairs must be carried out by an authorised repairer.

Battery Care

1. If over a period of time the battery quickly runs down after a full 24 hour charging period, a replacement battery is needed.
2. There will be some charge present in the battery but to ensure maximum running time, recharge your trimmer for 24 hours before use.
3. Permanent connection to the charger in a well ventilated area will automatically keep your battery fully charged ready for use.
4. To prevent permanent battery damage, never store in a discharged condition.
5. Contact your local approved service centre/dealer/distributor for a replacement battery and for safe disposal of your old battery .

6. Battery

12 Volt 5 Amp/Hour

"High Power"

Sealed for Life

No maintenance required

- **IMPORTANT**
DISPOSE OF YOUR OLD BATTERIES SAFELY
DO NOT CUT OPEN, BURN OR INCINERATE.

Battery Replacement

Should your battery need to be replaced contact your local approved service centre or dealer who will remove your old battery and fit a genuine Flymo replacement battery.

- **IMPORTANT**
The red lead should always be connected to the red terminal on the battery. The black lead should always be connected to the black terminal on the battery.

Bench Top Re-charging

The wall bracket can also be used as a "bench top" stand for re-charging your cordless trimmer.

Winter Storage

1. Fully charge for 24 hours before winter storage.
2. If you are unable to leave your cordless trimmer on permanent charge, re-charge the battery every 3 to 4 months for a full 24 hour charging period to top up the battery charge during winter storage.
3. Avoid extended storage without re-charge.
4. Store in a cool dry place.

For further information on Battery replacement contact Flymo/Partner Customer Service direct:-

Telephone	:	01325 300303
Fax	:	01325 318193

Product Rating Label

Your product is uniquely identified by a silver and black product rating label.

To ensure you have full product information when obtaining spares or advice from one of our approved service centres, or if you need to contact our customer service department, you should make a note in the space provided of the information shown in fig.B. It will also be useful to make a note of the date and place of purchase before you return your guarantee card.

B

Product Number

Model Number

Serial Number

Date of Purchase

Place of Purchase

•PLEASE KEEP PROOF OF PURCHASE•

Assembly Instructions

Safety Guard Assembly (C), (D), (E & F)

1. Locate the safety guard (C1) over the cutting head (C2). Ensure the nylon line is fed through the hole in the safety guard as illustrated in fig C.
 2. Align the arrow on the top of the safety guard (C3) with the arrow on the side of the trimmer (C4). See figs C & D.
 3. Push into location and turn safety guard anti-clockwise, as illustrated in Fig D until a click is heard and the safety guard is securely locked in position. See fig E.
- **ENSURE THE SAFETY GUARD IS SECURELY IN PLACE BY ATTEMPTING TO TWIST GUARD.** See fig F.

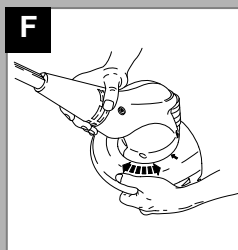
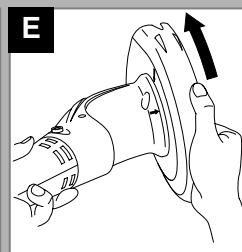
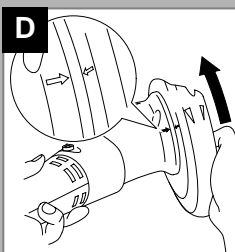
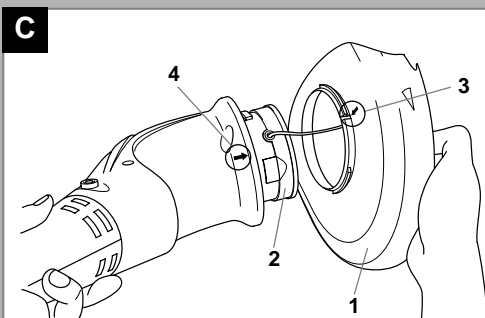

Fitting the wall bracket

G

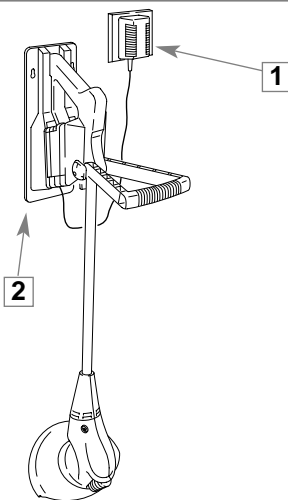

- **IMPORTANT !**
Switch charger off at the wall socket before connecting or disconnecting the trimmer to the wall bracket.

1. It is recommended that the wall bracket (G2) should be mounted on a smooth, vertical and internal wall which is strong enough to hold the weight of the product, in a well ventilated area between 5°C and 25°C.
2. There are 3 holes on the wall bracket. Position the wall bracket with the two holes at the top. **See Fig H.**
3. Ensure that when the trimmer is attached the bottom of the trimmer is within 4 inches (100 mm) of the ground, this will make it easier to hang the trimmer and will also ensure that the wall bracket is within easy reach of an electric socket to allow the charger to be plugged in.
4. Fix wall bracket securely to the wall with the plugs and screws provided.
5. Your cordless trimmer can now be attached to the wall bracket for charging.

Initial charging procedure and re-charging your cordless trimmer

H

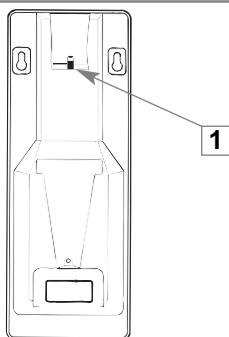

- **The battery should be charged for 24 hours before use.**
- **Re-charge your cordless trimmer immediately after every use for the full 24 hour charging period.**
- **The cordless trimmer can be left connected to the charger permanently, with the charger switched on, without fear of overcharging.**
- **The charger will automatically keep the battery topped up with charge during storage and will ensure that the cordless trimmer is ready for use.**

Initial Charging Procedure

1. Use the charger indoors only.
2. Ensure the charger is not exposed to moisture. Keep the charger and the trimmer dry at all times. Keep the charger well ventilated during charging.
3. Ensure the trimmer is correctly located into the wall bracket (G2) and the charge connector (H1).
4. Plug the charger (G1) into a suitable household electrical wall socket and switch on.
5. The red indicator lamp glows continuously during charging.
6. Full charge will be achieved in 24 hours. During charging the charger becomes warm. This is normal and means the charger is operating correctly.

Re-Charging Your Cordless Trimmer

1. Re-charge the battery as soon as the cutting power of your cordless trimmer begins to die and slow down.
2. Avoid running the cordless trimmer into "deep" discharge, i.e. avoid flattening the battery completely.
3. Follow the procedure outlined in the **Initial Charging Procedure.**
4. Charging the battery according to these instructions should ensure maximum battery life.

Handle Adjustment

1. Attach steady handle to product using bolt and handle knob as shown in Fig I.
2. Adjust the steady handle to a comfortable operating position, **see Fig J.**, by unscrewing the handle knob, springing the side lugs apart, moving the handle to the required position, carefully re-engaging the teeth and then tightening the handle knob. **See Fig K.**

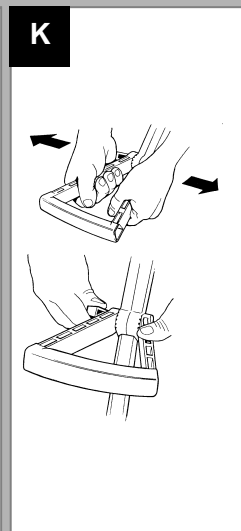
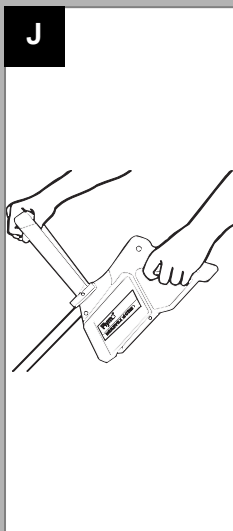
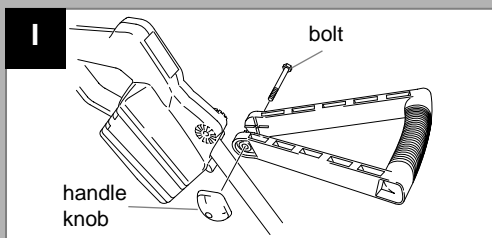

Auto Line Feed System

How the automatic line feed works (L)

1. A short length of new line is fed out every time you switch on, this is caused by the cutting head accelerating up to its full speed.
2. To feed more line, it is necessary to switch-off, allow the motor to stop and then restart. When edging do this frequently.
3. When the line feeds you will hear a change in the motor sound as well as the noise generated by the line being cut to its length.
4. If the line does not feed see **Fault Finding Hints** for further information.

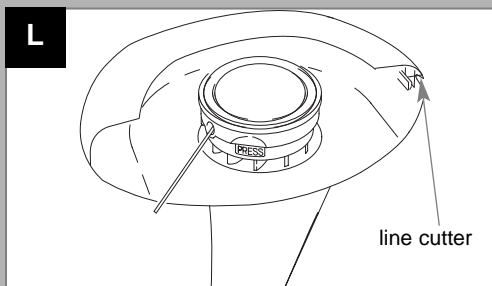

How to trim and edge

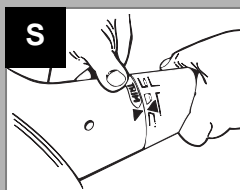
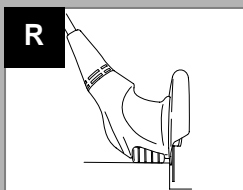
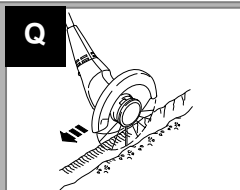
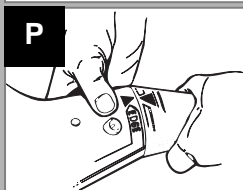
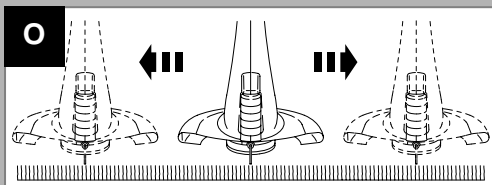
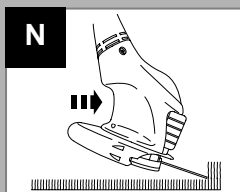
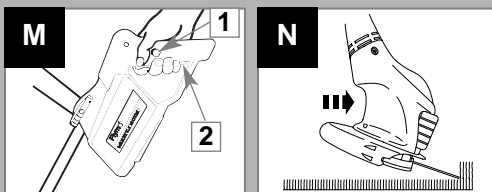

To start your trimmer

1. Hold as illustrated in Fig M.
2. To start, press lock-off button (M1), squeeze the switch lever (M2), release lock-off button.

How to trim

1. Cut with nylon line at an angle using the tip. **See Fig N**
2. Swing trimmer in and out of the cutting area taking small cuts (O)
3. Line is fed out automatically every time the trimmer head stops rotating and returns to operating speed.
 - Extra line can be fed out manually as described on page 9.
4. To stop you trimmer release the switch lever (M2).

How to edge

1. To convert to edging mode, depress locking button and twist head anti-clockwise until arrow lines up with "EDGE". An audible "click" will confirm that the head is locked. Ensure the button has returned to its original position. **See Fig P.**
2. Rest edger on roller for extra stability and line up with edge of lawn. See Fig R. Edge in direction indicated in Fig Q, so that debris is thrown away from you.
3. To return to trimming mode, depress locking button and twist head clockwise until arrow lines up with "TRIM". An audible "click" will confirm that the head is locked. Ensure the button has returned to its original position. **See Fig S.**

Spool Cap

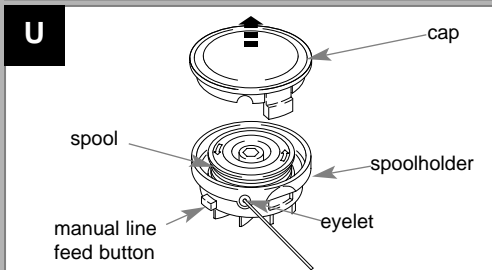
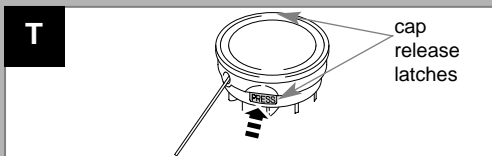

To remove spool cap

1. Press and hold in the two cap release latches. **See Fig T.**
2. Pull cap away from the cutting head. **See Fig U.**

When refitting the spool cap

1. Keep all areas of the cap and spoolholder clean. Failure to do so may prevent the cap being securely located in the spoolholder.
2. Align the two latches on the cap with the two windows in the spoolholder, then press down into the locked position.
3. Ensure the two cap release latches are clearly visible and are fully engaged with the windows in the spoolholder.
4. Check that the cap is correctly fitted by trying to remove it without depressing the two latches.

Nylon Line

To manually feed the nylon line

If required, line can be fed out manually. To operate, gently pull on the line whilst at the same time alternately pressing and releasing the button, on the side of the spoolholder. See fig V.

To replace nylon line. Replacement nylon line is available from most Flymo/Partner stockists. You can buy it either as spool and line complete, or as nylon line only.

To replace spool and line (complete)

1. Take new spool and remove tape holding line in place.
2. Unwind approximately 100mm of line and feed this through eyelet, see fig W, then drop the spool into spoolholder **smooth side uppermost**.

To replace nylon line on spool.

1. Take line and insert into hole in spool.
2. Turn spool clockwise to wind on required amount of line, (approx. half = 10m) and cut line to length, see fig X. Care should be taken to ensure that the line is neatly coiled on the spool. Failure to do so will impair the efficiency of the automatic line feed.
3. Leave approximately 100mm of line unwound and feed this through eyelet, see fig W, then drop the spool into the spoolholder **smooth side uppermost**.

V

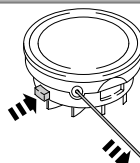

Do not depress the button more than three times. Excessive line will snag the line cutter and cause the trimmer to malfunction.

W

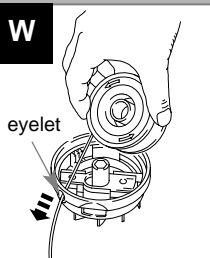

X

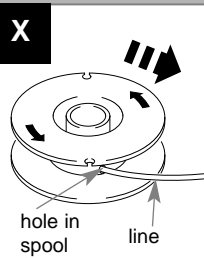

- **Ensure spool is fully located by gently rotating it during fitment.**
- **Remember! Your Flymo Cordless Trimmer is designed to use only nylon line with a maximum diameter of 1.5mm. Use only genuine Flymo nylon line.**

Caring for your Cordless Trimmer

After you have finished using your Flymo trimmer follow the procedure below:

1. Never clean your trimmer with water, cleaning fluids, or solvents, just remove debris with a suitable tool, a soft brush or dry cloth.
 2. Using the scraper provided, clean around the inside of the safety guard to remove any grass and debris. (Fig Y1)
 3. Using a soft brush, clean around the inside of the safety guard (Fig Y2), the cutting head (Fig Y3) and the motor housing. (Fig Y4)
 4. Inspect the trimmer carefully, especially the parts of the cutting head.
 5. If your trimmer is damaged in any way contact your local Flymo/Partner approved service centre.
- **Never use a damaged trimmer**
6. Wind cable carefully to avoid kinking.
 7. Store in a cool, dry place and out of reach of children.

Y

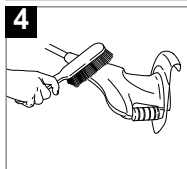
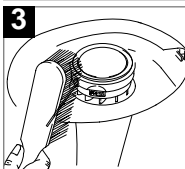
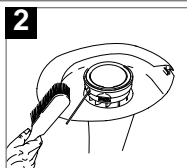
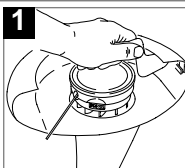

- **Avoid accidental starting. Keep your hands and fingers away from the switch lever while inspecting, cleaning or carrying out any maintenance work.**
- **Keep fingers and hands clear of line cutter on leading edge of guard.**

Fault Finding Hints & Service Recommendations

Fault Finding Hints

1. **Line too short**
Manually feed out the line.
2. **Line broken inside cutting head**
Remove cap and re-thread line.
3. **Line jammed on spool**
Remove cap and spool and rewind line to remove crossed loops.
4. **Excess line feed**
Battery needs to be charged.
5. **Poor performance**
Ensure inside of cutting head housing is clean and free from debris.
6. **Trimmer stops during use**
Release switch lever and wait 30 seconds before re-starting.

Service Recommendations

1. Always use genuine Flymo Spare Parts.
2. Prepacked spares are available from most Flymo/Partner stockists.
3. If you have a problem with your machine contact your local Approved Service Centre ensuring you have full details of your product as described on the product rating label.
4. **Should it be necessary for work to be carried out by your Service Centre, it is important to take your complete machine with you.**
5. In the event of further difficulty please contact:-
Flymo/Partner, Customer Service
Flymo/Partner
a division of Electrolux Outdoor
Products
Preston Road
Aycliffe Industrial Estate,
NEWTON AYCLIFFE,
Co. Durham.
DL5 6UP
Telephone: (01325) 300303
Fax : (01325) 318193

A network of specialist dealers can be found in your local Yellow Pages.

To obtain service on your Flymo product simply telephone or visit your local Service Centre.

Should you require service under the terms of our guarantee the Service Centre will require proof of purchase.

All of the centres listed stock genuine Flymo Spare Parts.

NOTE:

Our Service Repairers act on their own behalf and are not empowered to commit or legally bind Flymo/Partner in any manner whatsoever.

Guarantee & Guarantee Policy

If any part is found to be defective due to faulty manufacture within one year of original purchase, Flymo/Partner, through its Authorised Service Repairers will effect the repair or replacement to the customer free of charge providing:

- (a) The fault is reported directly to the Authorised Repairer.
- (b) Proof of purchase is provided.
- (c) The fault is not caused by misuse, neglect or faulty adjustment by the user.
- (d) The failure has not occurred through fair wear and tear.
- (e) The machine has not been serviced or repaired, taken apart or tampered with by any person not authorised by Flymo/Partner.
- (f) The machine has not been used for hire.
- (g) The machine is owned by the original purchaser.
- (h) The machine has not been used outside of the country for which it was specified.
- (i) The machine has not been used commercially.
- * This guarantee is additional to, and in no way diminishes the customers statutory rights.

Failures due to the following are not covered, therefore it is important that you read the instructions contained in this Operator's Manual and understand how to operate and maintain your machine:

Failures not covered by guarantee

- * Replacing nylon line.
- * Failures as a result of not reporting an initial fault.
- * Failures as a result of sudden impact.
- * Failures as a result of not using the product in accordance with the instructions and recommendations contained in this Operator's Manual.
- * Machines used for hire are not covered by this guarantee.
- * The following items listed are considered as wearing parts and their life is dependent on regular maintenance and are, therefore not normally subject to a valid warranty claim: Spool Cap, Nylon line.
- * **Caution!**
Flymo/Partner does not accept liability under the warranty for defects caused in whole or part, directly or indirectly by the fitting of replacement parts or additional parts that are not either manufactured or approved by Flymo/Partner, or by the machine having been modified in any way.

Environmental Information

Electrolux Outdoor Products are manufactured under an Environmental Management System (ISO 14001) using, where practical, components manufactured in the most environmentally responsible manner, according to company procedures, and with the potential for recycling at the end of the products' life.

- Packaging is recyclable and plastic components have been labelled (where practical) for categorised recycling.
- Awareness of the environment must be considered when disposing of 'end-of-life' product.
- If necessary, contact your local authority for disposal information.

Certificate of Conformity

I, the undersigned P. Howells of Electrolux Outdoor Products, Aycliffe Industrial Estate, NEWTON AYCLIFFE, Co. Durham. DL5 6UP. Certify that a sample of the above product has been tested and found to comply with directives:- 89/392/EEC, 89/336/EEC, 73/23/EEC

I, the undersigned P. Howells of Electrolux Outdoor Products, Aycliffe Industrial Estate, NEWTON AYCLIFFE, Co. Durham. DL5 6UP. Certify that a sample of the above product has been tested using directive 81/1051/EEC as a guide. The maximum A-weighted sound pressure level recorded at operator position under free field semi anechoic chamber conditions was :-

I, the undersigned P. Howells of Electrolux Outdoor Products, Aycliffe Industrial Estate, NEWTON AYCLIFFE, Co. Durham. DL5 6UP. Certify that a sample of the above product has been tested using ISO 5349 as a guide. The maximum weighted root mean square value of vibration recorded at operator's hand position was:-

Type	MCT-250
Identification of Series	See Product Rating Label
Level	77.2 dB(A)

Type	MCT-250
Identification of Series	See Product Rating Label
Value	1.6 m/s ²

Signed at
NEWTON
AYCLIFFE.....1999



Signed at
NEWTON
AYCLIFFE.....1999



Signed at
NEWTON
AYCLIFFE.....1999



Certificate of Conformity

I, THE UNDERSIGNED P. HOWELLS OF ELECTROLUX OUTDOOR PRODUCTS, AYCLIFFE INDUSTRIAL ESTATE, NEWTON AYCLIFFE, COUNTY DURHAM DL5 6UP ENGLAND

Certify that the Trimmer

- 1. Category **Electric**
 - 2. Make **Flymo**
- Conforms to the specifications of Directive 84/538/EEC/
Type of Cutting Device **Nylon Line**

TYPE	MCT250
Identification of Series	SEE PRODUCT RATING LABEL
Motor Manufacturer	Johnson HC785LG
Cutting System Width	25cm
Speed of Rotation of Cutting Device	9,400 RPM
Tested by (laboratory)	Ricardo
Guaranteed sound power level	91 dB(A)

Signed at
NEWTON AYCLIFFE
Date 1999.....



.....



The use of eye protection is recommended to protect against objects thrown by the cutting line.

Flymo Safety Glasses are available from most leading stockists

**GUIDE PRICE
ONLY £3.49**

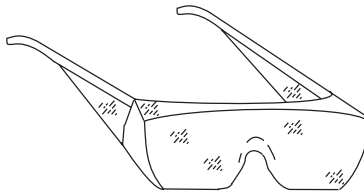

**GUIDE PRICE
ONLY £3.49**

Contact your nearest stockist or telephone
(01325) 300303 for more details

Electrolux Outdoor Products
Aycliffe Industrial Estate
NEWTON AYCLIFFE
Co.Durham DL5 6UP
ENGLAND

Telephone - (00) 44 1325 300303 Fax - (00) 44 1325 310339

UK Customer Helpline - 01325 300303 Fax - 01325 310339

Our policy of continuous improvement means that the specification of products may be altered from time to time without prior notice. Electrolux Outdoor Products manufacture products for a number of well known brands under various registered patents, designs and trademarks in several countries.

© Electrolux Outdoor Products Ltd. Registered Office, Electrolux Works, Oakley Road, Luton LU4 9QQ
Registered number 974979 England

5118561-02 (01/99)



Free Manuals Download Website

<http://myh66.com>

<http://usermanuals.us>

<http://www.somanuals.com>

<http://www.4manuals.cc>

<http://www.manual-lib.com>

<http://www.404manual.com>

<http://www.luxmanual.com>

<http://aubethermostatmanual.com>

Golf course search by state

<http://golfingnear.com>

Email search by domain

<http://emailbydomain.com>

Auto manuals search

<http://auto.somanuals.com>

TV manuals search

<http://tv.somanuals.com>