













<b>Welcome</b> .....	<b>2</b>	
<b>Important Safety Instructions</b> .	<b>3-5</b>	
<b>Features at a Glance</b> .....	<b>6</b>	
<b>Microwave Oven</b> <b>Important Information</b> .....	<b>7-8</b>	
<b>Setting Microwave Oven</b> <b>Controls</b> .....	<b>9-15</b>	
<b>Before Setting Wall Oven</b> <b>Controls</b> .....	<b>16</b>	
<b>Setting Wall Oven</b> <b>Controls</b> .....	<b>17-33</b>	
<b>Wall Oven</b> <b>Self-Cleaning Cycle</b> .....	<b>34-36</b>	
<b>Microwave Oven</b> <b>Care &amp; Cleaning</b> .....	<b>37</b>	
<b>Wall Oven</b> <b>Care &amp; Cleaning</b> .....	<b>38-40</b>	
<b>Adjusting your</b> <b>Oven Temperature</b> .....	<b>41</b>	
<b>Before You Call</b> Solutions to Common Problems .....	<b>42-43</b>	
<b>Warranty</b> .....	<b>Back Cover</b>	



# Welcome & Congratulations

## Questions?

**1-800-944-9044**

(United States)

**1-866-294-9911**

(Canada)

Please attach sales receipt here for future reference.

Congratulations on your purchase of a new appliance! At **Electrolux Home Products**, we are very proud of our product and are completely committed to providing you with the best service possible. Your satisfaction is our number one priority.

We know you'll enjoy your new appliance and **Thank You** for choosing our product. We hope you consider us for future purchases.

### PLEASE CAREFULLY READ AND SAVE THESE INSTRUCTIONS

This Use & Care Manual contains general operating instructions for your appliance and feature information for several models. Your product **may not** have all the described features. The graphics shown are representative. The graphics on your appliance may not look exactly like those shown. These instructions are not meant to cover every possible condition and situation that may occur. Common sense and caution must be practiced when installing, operating and maintaining any appliance.

**Please record your model and serial numbers below for future reference.**

Model Number: \_\_\_\_\_

Serial Number: \_\_\_\_\_

Purchase Date: \_\_\_\_\_

## Product Registration

### Register Your Product

The **PRODUCT REGISTRATION CARD** should be filled in completely, signed and returned to Electrolux Home Products.

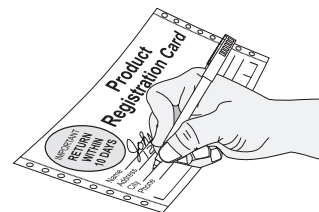

## Serial Plate Location

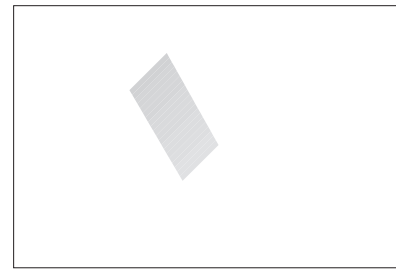

**Serial Plate Location**

### Versión en español

Si desea obtener una copia en español de este Manual del Usuario, sírvase escribir a la dirección que se incluye a continuación. Solicite la P/N 318200941E.

Spanish Use & Care Manual  
Electrolux Home Products  
P. O. Box 212378  
Augusta, GA 30917

# Important Safety Instructions



**Read all instructions before using this appliance.  
Save these instructions for future reference.**

This manual contains important safety symbols and instructions. Please pay attention to these symbols and follow all instructions given.

**⚠ WARNING** This symbol will help alert you to situations that may cause serious bodily harm, death or property damage.

**⚠ CAUTION** This symbol will help alert you to situations that may cause bodily injury or property damage.

## **⚠ PRECAUTIONS TO AVOID POSSIBLE EXPOSURE TO EXCESSIVE MICROWAVE ENERGY**

For your safety the information in this manual must be followed to minimize the risk of fire or explosion or to prevent property damage, personal injury or loss of life.

- **Do Not Attempt** to operate this microwave oven with the door open since open-door operation can result in harmful exposure to microwave energy. It is important not to defeat or tamper with the safety interlocks.
- **Do Not Place** any object between the microwave oven front face and the door or allow soil or cleaner residue to accumulate on sealing surfaces.
- **Do Not Operate** the microwave oven if it is damaged. It is particularly important that the microwave oven door close properly and that there is no damage to the:
  1. door (bent)
  2. hinges and latches (broken or loosened)
  3. door seals and sealing surfaces.
- **The Microwave Oven Should Not** be adjusted or repaired by anyone except properly qualified service personnel.

- **Remove all tape and packaging before using the appliance.** Destroy the carton and plastic bags after unpacking the appliance. Never allow children to play with packaging material.
- **Proper Installation. Be sure your appliance is properly installed and grounded by a qualified technician in accordance with National Electrical Code ANSI/NFPA No.70 (USA) or CSA C22.1, PART 1 (Canada)-latest edition and local code requirements.** Install only per installation instructions provided in the literature package for this appliance.

Ask your dealer to recommend a qualified technician and an authorized repair service. Know how to disconnect the electrical power to the appliance at the circuit breaker or fuse box in case of an emergency.

**⚠ CAUTION** Electronic controllers can be damaged by cold temperatures. When you use your appliance for the first time, or if it has not been used for a long period of time, make sure that it has been exposed to a temperature above 0°C/32°F for at least 3 hours before connecting it to the power supply.

- **User Servicing. Do not repair or replace any part of the appliance unless specifically recommended in the manuals.** All other servicing should be done only by a qualified technician to reduce the risk of personal injury and damage to the appliance.
- **Never modify or alter the construction of an appliance by removing panels, wire covers or any other part of the product.**
- **Remove the oven door from any unused appliance if it is to be stored or discarded.**

**⚠ WARNING** Stepping, leaning, sitting or pulling down on the door of this appliance can result in serious injuries and may also cause damage to the appliance. Do not allow children to climb or play around the appliance.

- **Storage on Appliance. Flammable materials should not be stored near surface units.** This includes paper, plastic and cloth items, such as cookbooks, plasticware and towels, as well as flammable liquids. Do not store explosives, such as aerosol cans, on or near the appliance. Flammable materials may explode and result in fire or property damage.



### **⚠ WARNING**

- All wall ovens can tip.
- Injury to persons could result.
- Install mounting bracket packed with wall oven.
- See Installation Instructions.



To reduce the risk of tipping, the wall oven must be secured by properly installed mounting bracket provided with the wall oven. Refer to the Installation Instructions for proper mounting bracket installation.



## Important Safety Instructions

**⚠ WARNING** Do not use the oven for storage.

**⚠ CAUTION** Do not store items of interest to children in the cabinets above an appliance. Children climbing on the appliance to reach items could be seriously injured.

- **Do not leave children alone. Children should not be left alone or unattended in the area where an appliance is in use.** They should never be allowed to sit or stand on any part of the appliance.
- **DO NOT TOUCH HEATING ELEMENTS OR INTERIOR SURFACES OF OVEN.** Heating elements may be hot even though they are dark in color. Interior surfaces of an oven become hot enough to cause burns. During and after use, do not touch, or let clothing or other flammable materials contact heating elements or interior surfaces of oven until they have had sufficient time to cool. Other surfaces of the appliance may become hot enough to cause burns - among these surfaces are (identification of surfaces- for example, oven vent openings and surfaces near these openings, oven doors, and windows of the oven doors).
- **Wear Proper Apparel. Loose-fitting or hanging garments should never be worn while using the appliance.** Do not let clothing or other flammable materials contact hot surfaces.

**⚠ WARNING** Never use your appliance for warming or heating the room.

- **Do Not Use Water or Flour on Grease Fires. Smother the fire with a pan lid, or use baking soda, a dry chemical or foam-type extinguisher.**
- **When heating fat or grease, watch it closely.** Fat or grease may catch fire if allowed to become too hot.
- **Use Only Dry Potholders. Moist or damp potholders on hot surfaces may result in burns from steam.** Do not let the potholders touch hot heating surface units. Do not use a towel or other bulky cloth instead of a potholder.
- **Do Not Heat Unopened Food Containers. Buildup of pressure may cause the container to burst and result in injury.**

**IMPORTANT—Do not attempt to operate the appliance during a power failure.** If power fails, always turn off the appliance. If the appliance is not turned off and the power resumes, it will begin to operate again. Once the power resumes, reset the clock and oven function.

## IMPORTANT INSTRUCTIONS FOR USING YOUR MICROWAVE

**⚠ WARNING** To reduce the risk of fire, burns, electric shock, injury to persons, or exposure to excessive microwave energy when using your appliance, follow basic *precautions, including the following sections.*

- Read all instructions before using the appliance.
- Read and follow the specific “**PRECAUTIONS TO AVOID POSSIBLE EXPOSURE TO EXCESSIVE MICROWAVE ENERGY**” on page 3.
- Some products such as whole eggs and sealed containers—for example, closed glass jars—are able to explode and should not be heated in this microwave oven.
- Use this appliance only for its intended use as described in this manual. Do not use corrosive chemicals or vapors in this appliance. This type of microwave oven is specifically designed to heat, cook or dry food. It is not designed for industrial or laboratory use.
- As with any appliance, close supervision is necessary when used by children.
- Do not operate this appliance if it is not working properly or if it has been damaged or dropped.
- Do not cover or block any openings on the appliance.
- Do not store or use this appliance outdoors. Do not use this product near water—for example, near a kitchen sink, in a wet basement or near a swimming pool, or similar locations.
- See door surface cleaning instructions on page 29.
- To reduce the risk of fire in the microwave oven cavity:
  - Do not overcook food. Carefully attend appliance when paper, plastic or other combustible materials are placed inside the microwave oven to facilitate cooking.
  - Remove wire twist-ties from paper or plastic bags before placing bag in microwave oven.
  - **If materials inside the microwave oven should ignite, keep microwave oven door closed, turn microwave oven off and disconnect the power cord or shut off power at the fuse or circuit breaker panel.**
  - Do not use the cavity for storage purposes. Do not leave paper products, cooking utensils or food in the cavity when not in use.
- Liquids, such as water, coffee or tea are able to be overheated beyond the boiling point without appearing to be boiling. Visible bubbling or boiling when the container is removed from the microwave oven is not always present. **THIS COULD RESULT IN VERY HOT LIQUIDS SUDDENLY BOILING OVER WHEN A SPOON OR OTHER UTENSIL IS INSERTED INTO THE LIQUID.**

# Important Safety Instructions



To reduce the risk of injury to persons:

- Do not overheat the liquid.
  - Stir the liquid both before and halfway through heating it.
  - Do not use straight-sided containers with narrow necks. Use a wide-mouthed container.
  - After heating, allow the container to stand in the microwave oven at least for 20 seconds before removing the container.
  - Use extreme care when inserting a spoon or other utensil into the container.
- If the microwave oven light fails, consult an Electrolux Authorized Servicer.

## IMPORTANT INSTRUCTIONS FOR USING YOUR WALL OVEN

- **Use Care When Opening an Oven Door**—Stand to the side of the appliance when opening the door of a hot oven. Let hot air or steam escape before you remove or replace food in the oven.
- **Keep Oven Vent Ducts Unobstructed.** The wall oven is vented at the upper control panel or at the center trim depending of the model. Touching the surfaces in this area when the wall oven is operating may cause severe burns. Also, do not place plastic or heat-sensitive items near the oven vent. These items could melt or ignite.
- **Placement of Oven Racks.** Always place oven racks in desired location while oven is cool. Remove all utensils from the rack before removing rack. If rack must be moved while oven is hot, use extreme caution. Use pot holders and grasp the rack with both hands to reposition. Do not let pot holders contact the hot oven element or interior of the oven.
- **Do not use the broiler pan without its insert.** The broiler pan and grid allow dripping fat to drain and be kept away from the high heat of the broiler.
- **Do not cover the broiler grid or oven bottom with aluminum foil.** Exposed fat and grease could ignite.
- **Do not touch a hot oven light bulb with a damp cloth.** Doing so could cause the bulb to break. Disconnect the appliance or shut off the power to the appliance before removing and replacing the bulb.
- **Protective liners**—Do not use aluminum foil to line the oven bottom. Only use aluminum foil as recommended in this manual. Improper installation of these liners may result in risk of electric shock, or fire.

## IMPORTANT INSTRUCTIONS FOR CLEANING YOUR WALL OVEN

- **Clean the appliance regularly to keep all parts free of grease that could catch fire.** Exhaust fan ventilation hoods and grease filters should be kept clean. Do not allow grease to accumulate. Greasy deposits in the fan could catch fire. Refer to the hood manufacturer's instructions for cleaning.

## SELF-CLEANING WALL OVEN MODELS

- **Clean in the self-cleaning cycle only the parts of the appliance listed in this Owner's Guide.** Before using the self-cleaning cycle of the appliance, remove the broiler pan and any utensils stored in the appliance.
- **Do not clean the oven door gasket.** The door gasket is essential for a good seal. Care should be taken not to rub, damage or move the gasket.
- **Do not use oven cleaners.** No oven cleaner or oven liner protective coating of any kind should be used in or around any part of the appliance

**CAUTION** The health of some birds is extremely sensitive to the fumes given off during the self-clean cycle of any wall oven. Move birds to another well ventilated room.

---

## IMPORTANT SAFETY NOTICE

The California Safe Drinking Water and Toxic Enforcement Act requires the Governor of California to publish a list of substances known to the state to cause cancer, birth defects or other productive harm, and requires businesses to warn customers of potential exposure to such substances.

---

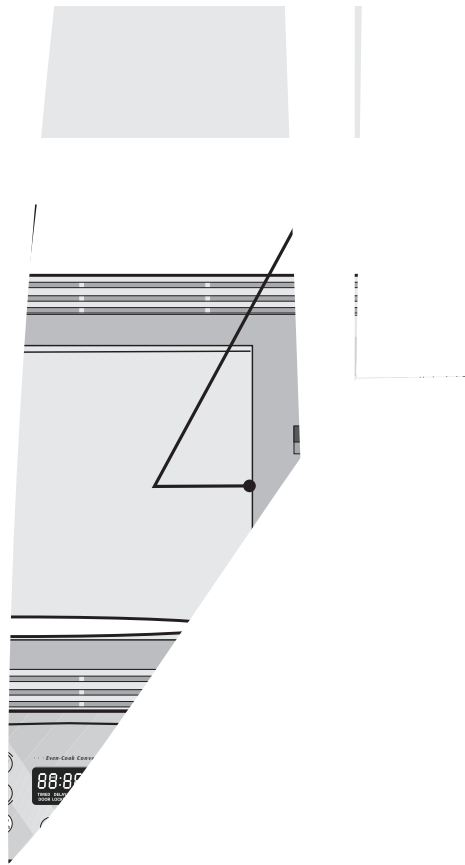

# Microwave Oven Important Information



## Radio or TV Interference

Should there be any interference caused by the microwave oven to your radio or TV, check that the microwave oven is on a different electrical circuit, relocate the radio or TV as far away from the microwave oven as feasible or check position and signal of receiving antenna.

## ABOUT YOUR MICROWAVE OVEN

This Use and Care Manual is valuable: read it carefully and always save it for reference.

A good microwave cookbook is a valuable asset. Check it for microwave cooking principles, techniques, hints and recipes.

**NEVER** use the microwave oven without the turntable and support nor turn the turntable over so that a large dish could be placed in the microwave oven. The turntable will turn both clockwise and counterclockwise.

**ALWAYS** have food in the microwave oven when it is on to absorb the microwave energy.

When using the microwave oven at power levels below 100%, you may hear the magnetron cycling on and off. It is normal for the exterior of the microwave oven to be warm to the touch when cooking or reheating.

Condensation is a normal part of microwave cooking. Room humidity and the moisture in food will influence the amount of moisture that condenses in the microwave oven. Generally, covered foods will not cause as much condensation as uncovered ones. Ventilation openings must not be blocked.

The microwave oven is for food preparation only. It should not be used to dry clothes or newspapers.

All microwave ovens are rated by using the IEC Test Procedure at 1200 watts. In using recipes or package directions, check food a minute or two before the minimum time setting elapses and add time accordingly.

## ABOUT MICROWAVE COOKING

- Arrange food carefully. Place thickest areas towards outside of dish.
- Watch cooking time. Cook for the shortest amount of time indicated and add more as needed. Food severely overcooked can smoke or ignite.
- Cover foods while cooking. Check recipe or cookbook for suggestions: paper towels, wax paper, microwave plastic wrap or a lid. Covers prevent spattering and help foods to cook evenly.
- Shield with small flat pieces of aluminum foil any thin areas of meat or poultry to prevent overcooking before dense, thick areas are cooked thoroughly.
- Stir foods from outside to center of dish once or twice during cooking, if possible.
- Turn foods over once during microwaving to speed cooking of such foods as chicken and hamburgers. Large items like roasts must be turned over at least once.
- Rearrange foods such as meatballs halfway through cooking both from top to bottom and from the center of the dish to the outside.
- Use standing time. Always allow food to stand in or out of the oven after cooking power stops. Standing time after defrosting or cooking allows the temperature to evenly spread throughout the food, improving the cooking results. For inside oven

standing time, you can program a “0” power stage of cooking cycle. See Multiple Stage Cooking.

- Check for doneness. Look for signs indicating that cooking temperatures have been reached.

### Doneness signs include:

- Food steams throughout, not just at edge.
- Center bottom of dish is very hot to the touch.
- Poultry thigh joints move easily.
- Meat and poultry show no pinkness.
- Fish is opaque and flakes easily with a fork.

## ABOUT FOODS

- Do not pop popcorn in your microwave oven unless in a special microwave popcorn accessory or unless you use popcorn labeled for use in microwave ovens.
- Some products such as whole eggs and sealed containers—for example, closed jars—will explode and should not be heated in this microwave oven. Such use of the microwave oven could result in injury.
- Do not boil eggs in a microwave oven. Pressure will build up inside egg yolk and will cause it to burst, possibly resulting in injury.
- Operating the microwave with no food inside for more than a minute or two may cause damage to the microwave oven and could start a fire. It increases the heat around the magnetron and can shorten the life of the microwave oven.
- Foods with unbroken outer “skin” such as potatoes, hot dogs, sausages, tomatoes, apples, chicken livers and other giblets, and egg yolks should be pierced to allow steam to escape during cooking.
- Avoid heating baby food in glass jars, even with the lid off. Make sure all infant food is thoroughly cooked. Stir food to distribute the heat evenly. Be careful to prevent scalding when warming formula or breast milk. The container may feel cooler than the milk really is. Always test the milk before feeding the baby.
- Spontaneous boiling—Under certain special circumstances, liquids may start to boil during or shortly after removal from the microwave oven. To prevent burns from splashing liquid, we recommend the following: before removing the container from the microwave oven, allow the container to stand in the microwave oven for 30 to 40 seconds after the microwave oven has shut off. Do not boil liquids in narrow-necked containers such as soft drink bottles, wine flasks and especially narrow-necked coffee cups. Even if the container is opened, excessive steam can build up and cause it to burst or overflow.
- Do not defrost frozen beverages in narrow-necked bottles (especially carbonated beverages). Even if the container is opened, pressure can build up. This can cause the container to burst, possibly resulting in injury.
- Hot foods and steam can cause burns. Be careful when opening any containers of hot food, including popcorn bags, cooking pouches and boxes. To prevent possible injury, direct steam away from hands and face.
- Do not overcook potatoes. They could dehydrate and catch fire, causing damage to your microwave oven.
- Cook meat and poultry thoroughly—meat to at least an INTERNAL temperature of 160½F and poultry to at least an INTERNAL temperature of 170½F. Cooking to these temperatures usually protects against foodborne illness.



# Microwave Oven Important Information

## ABOUT UTENSILS AND COVERINGS

It is not necessary to buy all new cookware. Many pieces already in your kitchen can be used successfully in your new microwave oven. Make sure the utensil does not touch the interior walls during cooking.

### Use these utensils for safe microwave cooking and reheating:

- glass ceramic (Pyroceram®), such as Corningware®.
- heat-resistant glass (Pyrex®)
- microwave-safe plastics
- paper plates
- microwave-safe pottery, stoneware and porcelain
- browning dish (Do not exceed recommended preheating time. Follow manufacturer's directions.)

### These items can be used for short time reheating of foods that have little fat or sugar in them:

- wood, straw, wicker

## DO NOT USE

- metal pans and bakeware
- dishes with metallic trim
- non-heat-resistant glass
- non-microwave-safe plastics (margarine tubs)
- recycled paper products
- brown paper bags
- food storage bags
- metal twist-ties

Should you wish to check if a dish is safe for microwaving, place the empty dish in the microwave oven and microwave on HIGH for 30 seconds. A dish which becomes very hot should not be used.

## The following coverings are ideal:

- Paper towels are good for covering foods for reheating and absorbing fat while cooking bacon.
- Wax paper can be used for cooking and reheating.
- Plastic wrap that is specially marked for microwave use can be used for cooking and reheating. DO NOT allow plastic wrap to touch food. Vent so steam can escape.
- Lids that are microwave-safe are a good choice because heat is kept near the food to hasten cooking.
- Oven cooking bags are good for large meats or foods that need tenderizing. DO NOT use metal twist ties. Remember to slit bag so steam can escape.

## How to use aluminum foil in your microwave oven:

- Small flat pieces of aluminum foil placed smoothly on the food can be used to shield areas that are either defrosting or cooking too quickly.
- Foil should not come closer than one inch to any surface of the microwave oven.

Should you have questions about utensils or coverings, check a good microwave cookbook or follow recipe suggestions.

**ACCESSORIES** There are many microwave accessories available for purchase. Evaluate carefully before you purchase so that they meet your needs. A microwave-safe thermometer

will assist you in determining correct doneness and assure you that foods have been cooked to safe temperatures. Electrolux is not responsible for any damage to the microwave oven when accessories are used.

## ABOUT CHILDREN AND THE MICROWAVE

Children below the age of 7 should use the microwave oven with a supervising person very near to them. Between the ages of 7 and 12, the supervising person should be in the same room.

At no time should anyone be allowed to lean or swing on the microwave oven door.

Children should be taught all safety precautions: use potholders, remove coverings carefully, pay special attention to packages that crisp food because they may be extra hot. Don't assume that because a child has mastered one cooking skill he/she can cook everything.

Children need to learn that the microwave oven is not a toy. See page 15 for Child Lock feature.

## ABOUT SAFETY

- Check foods to see that they are cooked to the United States Department of Agriculture's recommended temperatures.

---

160½F - For fresh pork, ground meat, boneless white poultry, fish, seafood, egg dishes and frozen prepared food.

---

165½F - For leftover, ready-to-reheat refrigerated, and deli and carry-out "fresh" food.

---

170½F - White meat of poultry.

---

175½F - Dark meat of poultry.

---

To test for doneness, insert a meat thermometer in a thick or dense area away from fat or bone. NEVER leave the thermometer in the food during cooking, unless it is approved for microwave oven use.

- ALWAYS use potholders to prevent burns when handling utensils that are in contact with hot food. Enough heat from the food can transfer through utensils to cause skin burns.
- Avoid steam burns by directing steam away from the face and hands. Slowly lift the farthest edge of a dish's covering and carefully open popcorn and oven cooking bags away from the face.
- Stay near the microwave oven while it's in use and check cooking progress frequently so that there is no chance of overcooking food.
- NEVER use the cavity for storing cookbooks or other items.
- Select, store and handle food carefully to preserve its high quality and minimize the spread of foodborne bacteria.
- Keep waveguide cover clean. Food residue can cause arcing and/or fires.
- Use care when removing items from the microwave oven so that the utensil, your clothes or accessories do not touch the safety door latches.



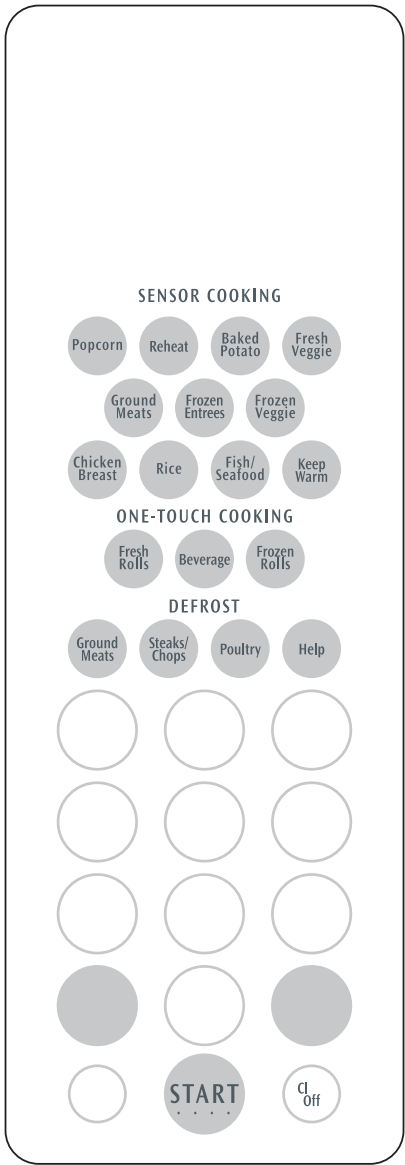



# Setting Microwave Oven Controls

## Microwave Manual Operation (continued)

Touch Power Level Pad Number of Times for Desired Power	Approximate Percentage of Power	Common Words for Power Levels
Power Level x 1	100%	High
Power Level x 2	90%	
Power Level x 3	80%	
Power Level x 4	70%	Medium High
Power Level x 5	60%	
Power Level x 6	50%	Medium
Power Level x 7	40%	
Power Level x 8	30%	Med Low/Defrost
Power Level x 9	20%	
Power Level x 10	10%	Low
Power Level x 11	0%	Standing Time

### MANUAL DEFROST

If the food that you wish to defrost is not listed on the DEFROST TABLE or is above or below the limits in the Amount column on the DEFROST TABLE, you need to defrost manually. You can defrost any frozen food, either raw or previously cooked, by using **Power Level** for 30%. Follow the exact 3-step procedure found under TO SET POWER LEVEL. Estimate defrosting time and press **Power Level** pad eight times for 30%. For either raw or previously cooked frozen food the rule of thumb is approximately 4 minutes per pound. For example, defrost 4 minutes for 1 pound of frozen spaghetti sauce. Always stop the microwave oven periodically to remove or separate the portions that are defrosted. If food is not defrosted at the end of the estimated defrosting time, program the microwave oven in 1 minute increments on **Power Level** 30% until totally defrosted. When using plastic containers from the freezer, defrost only long enough to remove food from the plastic in order to place in a microwave-safe dish.

## Special Features

### SENSOR COOKING

The Sensor is a semi-conductor device that detects the vapor (moisture and humidity) emitted from the food as it heats, and then adjusts the cooking times and power level for various foods and quantities.

#### Using Sensor Settings:

1. After microwave oven is plugged in, wait 2 minutes before using SENSOR COOKING.
2. Be sure the exterior of the cooking container and the interior of the microwave oven are dry. Wipe off any moisture with a dry cloth or paper towel.
3. The microwave oven works with foods at normal storage temperature. For example, popcorn would be at room temperature, frozen dinner would be at freezer temperature.
4. Any SENSOR COOKING selection can be programmed with More or Less Time Adjustment. See page 16.
5. More or less food than the quantity listed in the Sensor Cooking Table should be cooked following the guidelines in any microwave cookbook.
6. During the first part of SENSOR COOKING, food selection name will appear on the display. Do not open the microwave oven door or touch **Clear/Off** during this part of the cooking cycle. The measurement of vapor will be interrupted. If this occurs, an error message will appear. To continue cooking, touch the **Clear/Off** pad and cook manually.  
When the sensor detects the vapor emitted from the food, remainder of cooking time will appear. Door may be opened when remaining cooking time appears on the display. At this time, you may stir or season food, as desired.
7. If the sensor does not detect vapor properly when

popping popcorn, the microwave oven will turn off, and the correct time of day will be displayed. If the sensor does not detect vapor properly when cooking other foods, *ERROR* will be displayed, and the microwave oven will turn off.

8. Check food for temperature after cooking. If additional time is needed, continue to cook manually.
9. Each food selection pad has a cooking hint. Touch **Help** pad when the HELP indicator is lighted in the display.

**IMPORTANT OPERATION NOTE:** You must touch a Sensor Cooking pad within 3 minutes of opening and closing the oven door at the beginning of a new cooking cycle. If you do not, the pad will not work until you touch **Clear/Off**.

#### Covering Foods:

Some foods work best when covered. Use the cover recommended in the SENSOR COOKING TABLE for these foods.

1. Casserole lid.
2. Plastic wrap: Use plastic wrap recommended for microwave cooking. Cover dish loosely; allow approximately 1/2 inch to remain uncovered to allow steam to escape. Plastic wrap should not touch food.
3. Wax paper: Cover dish completely; fold excess wrap under dish to secure. If dish is wider than paper, overlap two pieces at least one inch to cover.

Be careful when removing any covering to allow steam to escape away from you.

#### EXAMPLE:

You can cook many foods by touching just one pad. You don't need to calculate cooking time or power level.

- Suppose you want to reheat chili. Touch **Reheat** pad.

When sensor detects the vapor emitted from the food, remainder of reheating time will appear.

# Setting Microwave Oven Controls



## Special Features (continued)

### SENSOR COOKING TABLE

FOOD	AMOUNT	PROCEDURE															
Popcorn	1 package 1.5 - 3.5 oz bag	Use only popcorn packaged for microwave oven use. Try several brands to decide which you like. Do not try to pop unpopped kernels. Touch <b>Popcorn</b> pad.															
Reheat	4 - 36 oz	Place food in dish or casserole slightly larger than amount to be reheated. Flatten, if possible. Cover with lid, plastic wrap or wax paper. Use covers such as plastic wrap or lids with larger quantities of more dense foods such as stews. After reheating, stir well, if possible. Re-cover and allow to stand 2 to 3 minutes. Foods should be hot. If not, continue to heat with variable power and time.															
Baked Potato	1 - 8 med.	Pierce. Place on paper-towel-lined turntable. After cooking, remove from microwave oven, wrap in aluminum foil and let stand 5 to 10 minutes.															
Fresh Veggie: Soft Broccoli Brussels sprouts Cabbage Cauliflower (flowerets) Cauliflower (whole) Spinach Zucchini Baked apples	.25 - 2.0 lb .25 - 2.0 lb .25 - 2.0 lb .25 - 2.0 lb 1 med. .25 - 1.0 lb .25 - 2.0 lb 2 - 4 med.	Wash and place in casserole. Add no water if vegetables have just been washed. Cover with lid for tender vegetables. Use plastic wrap for tender-crisp vegetables. Touch <b>Fresh Veggie</b> pad. After cooking, stir, if possible. Let stand, covered, for 2 to 5 minutes.															
Fresh Veggie: Hard Carrots, sliced Corn on the cob Green beans Winter squash: diced halves	.25 - 1.5 lb 2 - 4 .25 - 1.5 lb .25 - 1.5 lb 1 - 2	Place in casserole. Add 1-4 tbsp water. Cover with lid for tender vegetables. Use plastic wrap cover for tender-crisp vegetables. Touch <b>Fresh Veggie</b> pad twice. After cooking, stir, if possible. Let stand, covered, for 2 to 5 minutes.															
Ground Meats	.25 - 2.0 lb	Use this setting to cook ground beef or turkey as patties or in a casserole to be added to other ingredients. Place patties on a microwave-safe rack and cover with wax paper. Place ground meat in a casserole and cover with wax paper or plastic wrap. When microwave oven stops, turn patties over or stir meat in casserole to break up large pieces. Re-cover and touch <b>START</b> . After cooking, let stand, covered, for 2 to 3 minutes.															
Frozen Entrees	6 - 17 oz	Use this pad for frozen convenience foods. It will give satisfactory results for most brands. You may wish to try several and choose your favorite. Remove package from outer wrapping and follow package directions for covering. After cooking, let stand, covered, for 1-3 minutes.															
Frozen Veggie	.25 - 1.5 lb	Add no water. Cover with lid or plastic wrap. After cooking, stir and let stand, covered, for 3 minutes.															
Chicken Breast	.5 - 2.0 lb	Cover with vented plastic wrap. Touch <b>Chicken Breast</b> pad. When microwave oven stops, turn over. Shield with small, flat pieces of aluminum foil any areas that are cooking too rapidly. Re-cover and touch <b>START</b> . After cooking, let stand, covered 3-5 minutes. Chicken should be 160°F.															
Rice	.5 - 2.0 cups	Place rice into a deep casserole and add double quantity of water (see below). Cover with lid or plastic wrap. After cooking, stir, cover and let stand 3 to 5 minutes or until all liquid has been absorbed. <table border="1" style="margin-left: auto; margin-right: auto;"> <thead> <tr> <th>Rice</th> <th>Water</th> <th>Size of casserole</th> </tr> </thead> <tbody> <tr> <td>.5 cup</td> <td>1 cup</td> <td>1.5 quart</td> </tr> <tr> <td>1 cup</td> <td>2 cups</td> <td>2 quart</td> </tr> <tr> <td>1.5 cups</td> <td>3 cups</td> <td>2.5 or 3 quart</td> </tr> <tr> <td>2 cups</td> <td>4 cups</td> <td>3 quart or larger</td> </tr> </tbody> </table>	Rice	Water	Size of casserole	.5 cup	1 cup	1.5 quart	1 cup	2 cups	2 quart	1.5 cups	3 cups	2.5 or 3 quart	2 cups	4 cups	3 quart or larger
Rice	Water	Size of casserole															
.5 cup	1 cup	1.5 quart															
1 cup	2 cups	2 quart															
1.5 cups	3 cups	2.5 or 3 quart															
2 cups	4 cups	3 quart or larger															
Fish/Seafood	.25 - 2.0 lb	Arrange in ring around shallow glass dish (roll fillet with edges underneath). Cover with vented plastic wrap. After cooking, let stand, covered for 3 minutes.															



# Setting Microwave Oven Controls

## Special Features (continued)

### ONE-TOUCH COOKING

ONE-TOUCH COOKING allows you to cook or reheat many of your favorite foods by touching just one pad.

• Suppose you want to heat 2 fresh rolls or muffins. Touch **Fresh Rolls** pad 2 times. The microwave oven starts automatically.

#### NOTE:

1. To increase quantity, touch chosen pad until number in display is same as desired quantity to cook. Ex: touch **Beverage** two times for one cup. More or less food than the quantity listed in the table should be heated following the guidelines in any microwave cookbook.

2. ONE-TOUCH COOKING can be programmed with More or Less Time Adjustment. See page 16.

3. The final result will vary according to the food condition (e.g. initial temperature, shape, quality). Check food for temperature after heating. If additional time is needed, continue to heat manually.

**IMPORTANT OPERATION NOTE:** You must touch a One-Touch Cooking pad within 3 minutes of opening and closing the oven door at the beginning of a new cooking cycle. If you do not, the pad will not work until you touch **Clear/Off**.

### ONE-TOUCH COOKING TABLE

FOOD	AMOUNT	PROCEDURE
Fresh Rolls	1 - 10 pieces	Use this pad to warm rolls, muffins, biscuits, bagels etc. Large items should be considered as 2 or 3 of regular size. Arrange on plate; cover with paper towel. For refrigerated rolls or muffins, it may be necessary to double the entered amount to ensure the proper serving temperature. For example, enter quantity of 2 for 1 refrigerated muffin.
Beverage	.5 - 2.0 cups	This setting is good for restoring cooled beverage to a better drinking temperature. Stir liquid briskly before heating to avoid "eruption". Touch <b>Beverage</b> pad. <b>Press the pad for amount</b> Once .5 cup Twice 1 cup 3 times 1.5 cups 4 times 2 cups
Frozen Rolls	1 - 10 pieces	Use this pad to warm rolls, muffins, biscuits, bagels etc. Large items should be considered as 2 or 3 of regular size. Arrange on plate; cover with paper towel.

# Setting Microwave Oven Controls



## Special Features (continued)

### DEFROST

DEFROST automatically defrosts all the foods shown in the DEFROST TABLE.

Round the weight to the nearest half pound. (Ex: if the steak's actual weight is 2.2 lb round to 2.0 lb If the steak's weight is 2.4 lb round to 2.5 lb.)

To enter weight, touch the desired DEFROST pad for a 0.5 lb increase per touch. (Ex: touch four times for 2.0 lb.)

You must enter the weight within 1 second of touching the Defrost pad, or the oven will begin defrosting. To return to adjust the weight, **you must touch Clear/Off twice.**

• Suppose you want to defrost a 2.0 pound steak.

1. Quickly touch **Steak/Chops** pad 4 times for 2.0 lb. The microwave oven will start automatically.

The microwave oven will stop and directions will be displayed. Follow the indicated message.

2. After the 1st stage, open the door, turn steak over and shield any warm portions with aluminum foil. Close the door. Touch **START** pad.

3. After the 2nd stage, open the door and shield any warm portions. Close the door. Touch **START** pad.

After defrost cycle ends, cover and let stand as indicated in table.

### DEFROST TABLE

FOOD	AMOUNT	PROCEDURE
Ground Meats	.5 - 2.0 lb	Remove any thawed pieces after each stage. Let stand, covered, for 5 to 10 minutes.
Steaks/Chops	.5 - 3.0 lb	After each stage, rearrange and if there are warm or thawed portions, shield with small flat pieces of aluminum foil. Remove any meat or fish that is nearly defrosted. Let stand, covered, for 10 to 20 minutes.
Poultry (Pieces)	.5 - 3.0 lb	After each stage, if there are warm or thawed portions, rearrange or remove. Let stand, covered, for 10 to 20 minutes.

### KEEP WARM

Keep Warm allows you to keep food warm up to 30 minutes.

#### DIRECT USE

• Suppose you want to keep a cup of soup warm for 15 minutes.

1. Touch **Keep Warm** pad.

2. Enter time 1,5,0,0.

3. Touch **START** pad.

The microwave oven will start. The display will show 15.00 and count down. **KEEP WARM** will be displayed during the count down.

You can program Keep Warm with manual cooking to keep food warm continuously after cooking.

#### NOTE:

1. If you attempt to enter more or less than the allowed weight as indicated in table, **ERROR** will appear in the display.
2. DEFROST can be programmed with More or Less Time Adjustment. See page 16.
3. To defrost other foods or foods above or below the weights allowed on DEFROST TABLE use time and 30% power. See Manual Defrost on page 11.
4. You may choose to enter the weight in tenths of a pound. This procedure may be easier with larger weights, such as 3 pounds, because it requires fewer touches. To program, touch desired DEFROST pad and enter weight by touching the number pads. Ex: touch **Steaks/Chops** then 3 and 0 for a weight of three pounds or touch **Steaks/Chops** then 2 and 2 for a weight of 2.2 lb.

**IMPORTANT OPERATION NOTE:** You must touch a Defrost pad within 3 minutes of opening and closing the oven door at the beginning of a new cooking cycle. If you do not, the pad will not work until you touch **Clear/Off**.

#### WITH MANUAL COOKING

• Suppose you want to cook a cup of soup for 2 minutes at 70% and keep the soup warm for 15 minutes.

1. Enter cooking time 2,0,0.

2. Touch **Power Level** pad 4 times for 70% power.

3. Touch **Keep Warm** pad.

4. Enter time 1,5,0,0.

5. Touch **START** pad.

The operation will start. When the cooking time is complete, a long tone will sound and **Keep Warm** will start. The display will count down for 15 minutes and **KEEP WARM** will be displayed during the count down.

**NOTE:** Keep Warm cannot be programmed with **SPECIAL FEATURES**.



# Setting Microwave Oven Controls

## Other Convenient Features

### HELP

Help provides 4 features that make using your microwave oven easy because specific instructions are provided in the interactive display.

#### 1. Child Lock

The Child Lock prevents unwanted microwave oven operation such as by small children. The microwave oven can be set so that the control panel is deactivated or locked. To set, touch **Help**, the number 1 and then touch the **START** pad. Should a pad be touched, *CHILD LOCK ON* will appear in the display. To cancel, touch **Help** and **Clear/Off** pad.

#### 2. Audible Signal Elimination

If you wish to have the microwave oven operate with no audible signals, touch **Help**, the number 2 and **Clear/Off**. To cancel and restore the audible signal, touch **Help**, the number 2 and **START**.

#### 3. Auto Start

If you wish to program your microwave oven to begin cooking automatically at a designated time of day, follow this procedure:

- Suppose you want to start cooking a stew for 20 minutes on 50% at 4:30. Before setting, check to make sure the clock is showing the correct time of day.
1. Touch **Help** pad.
  2. Touch number 3.
  3. Enter number 4,3,0 for start time.
  4. Touch **Timer/Clock** pad.
  5. Enter cooking program by touching number 2,0,0,0, **Power Level** pad 6 times.
  6. Touch **START** pad; auto start time appears in the display.

#### NOTE:

1. Auto Start can be used for manual cooking if clock is set.
2. If the microwave oven door is opened after programming Auto Start, it is necessary to touch the **START** pad for Auto Start time to appear in the readout so that the microwave oven will automatically begin programmed cooking at the chosen Auto Start time.
3. Be sure to choose foods that can be left in the microwave oven safely until the Auto Start time. Acorn or butternut squash are often a good choice. Do not use foods that can easily spoil.
4. If you wish to know the time of day, simply touch the **Timer/Clock** pad. As long as your finger is touching the **Timer/Clock** pad, the time of day will be displayed.

#### 4. Language/Weight Selection

The microwave oven comes set for English and U.S. Customary Unit-pounds. To change, touch **Help** and the number 4. Continue to touch the number 4 until your choice is selected from the table below. Then, touch **START**.

- Touch number 4 once for English/LB.
- Touch number 4 twice for English/KG.
- Touch number 4 three times for Spanish/LB.
- Touch number 4 four times for Spanish/KG.
- Touch number 4 five times for French/LB.
- Touch number 4 six times for French/KG.

#### HELP (In display)

Whenever HELP is lighted in the Interactive Display, touch **Help** to read cooking and operating hints.

#### MULTIPLE STAGE COOKING

Your microwave oven can be programmed for sequence of up to 4 cooking stages, switching from one power level setting to another automatically.

Sometimes cooking directions tell you to start on one power level and then change to a different power level. Your microwave oven can do this automatically.

- Suppose you want to cook roast beef for 5 minutes at 100%, continue to cook for 30 minutes at 50% and finish with 5 minutes of standing time in oven.
1. First enter cooking time. Then touch **Power Level** pad once for 100% power.
  2. Enter second cooking time. Touch **Power Level** pad 6 times for 50% power.
  3. Enter the standing time. Touch **Power level** pad 11 times.
  4. Touch **START** pad.

#### NOTE:

1. If you wish to know power level, simply touch the **Power Level** pad. As long as your finger is touching the **Power Level** pad, the power level will be displayed.
2. If 100% is selected as the final sequence, it is not necessary to touch the **Power Level** pad.



## Other Convenient Features

### PLUS 1 MIN

Plus 1 Min allows you to cook for a minute at 100% by simply touching the **Plus 1 Min** pad. You can also extend cooking time in multiples of 1 minute by repeatedly touching the **Plus 1 Min** pad during manual cooking.

#### NOTE:

1. To use **Plus 1 Min**, touch pad within 3 minutes after cooking, closing the door, touching the **Clear/Off** pad or during cooking.
2. **Plus 1 Min** cannot be used with Special Features.

### DEMONSTRATION MODE

To demonstrate, touch **Timer/Clock**, the number 0 and touch **START** and hold for 3 seconds. *DEMO ON* will appear in the display. Cooking operations and specific special features can now be demonstrated with no power in the microwave oven. For example, touch **Clear/Off** and touch **Plus 1 Min**, and the display will show *1.00* and count down quickly to *END*.

To cancel, touch **Timer/Clock**, then the number 0 and **Clear/Off**. If easier, unplug the microwave oven from the electrical outlet, replug and set the clock.

### MORE OR LESS DONE ADJUSTMENT

You may discover that you like the results of one of the cooking functions (Sensor Cooking, One-Touch Cooking, or Defrost) slightly **more** or **less** done.

- For more done, touch the Power Level pad once within 1 second after selecting a cooking function. MORE will appear in the display.
- For less done, touch the Power Level pad twice within 1 second after selecting a cooking function. LESS will appear in the display.

If you fail to touch the Power Level pad within 1 second after selecting a cooking function, the oven will start the function. To return to adjust function to more or less **you must touch Clear/Off twice**.

### TIMER

- Suppose you want to time a 3 minute long distance phone call.
  1. Touch **Timer/Clock** pad and number 1.
  2. Touch 3,0,0 to enter time.
  3. Touch **Timer/Clock** pad. The Timer will count down.

## Open Vent and Racks

Vent Location



**⚠ CAUTION** Some models are equipped with a blower which runs in baking and self-cleaning mode to keep all internal components at a cool temperature. The blower may keep running even if the oven has been turned off, until the

cul  
for circ  
for pro  
with othe  
circulate  
around



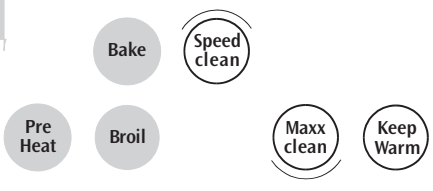

• • • *Even-Cook Convection Oven* • • •



# Setting Wall Oven Controls

## Setting the Clock

The **Clock** pad is used to set the clock. The clock may be set for 12 or 24 hour time of day operation. The clock has been preset at the factory for the 12 hour operation. When the range is first plugged in, or when the power supply to the range has been interrupted, the timer in the display will flash along with "PF" (power failure, See Figure 1).

When **PF** appears in the display and 12:00 is flashing, press **Clear/Off**. No sound will be heard, but after 10 seconds a beep will sound and PF will disappear.

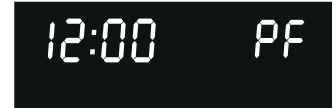

Figure 1

### INSTRUCTIONS

#### To set the clock (example below for 1:30)

1. Press **Clock**. "CLO" will appear in the display (Figure 2).
2. Press **1** **3** **0** pads to set the time of day to 1:30 (Figure 3).  
"CLO" will stay in the display. Press **START**. "CLO" will disappear and the clock will start (Figure 4).

### PRESS



### DISPLAY



Figure 2



Figure 3

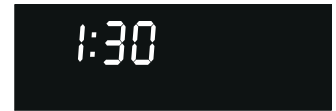

Figure 4



Figure 5



Figure 6

#### Changing between 12 or 24 hour time of day display

1. Press and hold **Clock** for 7 seconds (Figure 3). After 7 seconds, "12Hr" (Figure 5) or "24Hr" (Figure 6) will appear in the display and the control will beep once.
2. Press **Clean** to switch between the 12 and 24 hour time of day display. The display will show either "12Hr" (Figure 5) or "24Hr" (Figure 6).
3. Press **START** to accept the change or press **Clear/Off** to reject the change.
4. Reset the correct time as described in **To set the Clock** above. Please note that if the 24 hour time of day mode was chosen, the clock will now display time from 0:00 through 23:59 hours.

**Clock** for 7 seconds



# Setting Wall Oven Controls



## Setting the Clock (continued)

### Setting Continuous Bake or 12 Hour Energy Saving

The **TIMER ON/OFF** (Timer On/Off) and **CLEAN** (Clean) pads control the Continuous Bake or 12 Hour Energy Saving features. The oven control has a factory preset built-in 12 Hour Energy Saving feature that will shut off the oven if the oven control is left on for more than 11 hours and 59 minutes. The oven can be programmed to override this feature for Continuous Baking.

#### INSTRUCTIONS

#### To set the control for Continuous Bake or 12 Hour Energy Saving features

1. Press and hold **TIMER ON/OFF** for 7 seconds (Figure 1). After 7 seconds "12Hr" or "- -Hr" will appear in the display and the control will beep once.
2. Press **CLEAN** to switch between the 12 Hour Energy Saving and continuous bake features. Note: "12Hr" (Figure 2) in the display indicates the control is set for the 12 Hour Energy Saving mode and "- -Hr" indicates the control is set for the Continuous Bake feature (Figure 3).
3. Press **START** to accept the change (Figure 4; display will return to time of day) or press **CLEAR / Off** to reject the change.

#### PRESS

#### DISPLAY

**TIMER ON/OFF** for 7 seconds



Figure 1

**CLEAN**



Figure 2

**START**



Figure 3

**CLEAR / Off**

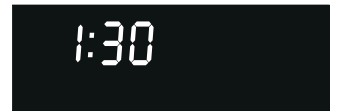

Figure 4

### Setting Timer

The **TIMER ON/OFF** (Timer On/Off) pad controls the Timer feature. The Timer serves as an extra timer in the kitchen that will beep when the set time has run out. It does not start or stop cooking. The Timer feature can be used during any of the other oven control functions. Refer to "Minimum and Maximum Control Pad Settings" for time amount settings.

#### INSTRUCTIONS

#### To set the Timer (example for 5 minutes)

1. Press **TIMER ON/OFF**. "0:00" will appear and "TIMER" will flash in the display (Figure 5).
2. Press the number pads to set the desired time in the display (example **5**). Press **START**. The time will begin to count down with "5:00" and "TIMER" will stay in the display (Figure 6). Note: If **START** is not pressed the timer will return to the time of day after 25 seconds.
3. When the set time has run out, "End" and "TIMER" will show in the display (Figure 7). The clock will sound with 3 beeps every 7 seconds until **TIMER ON/OFF** is pressed.

#### PRESS

#### DISPLAY

**TIMER ON/OFF**



Figure 5

**5** **START**



Figure 6

**TIMER ON/OFF**



Figure 7

#### To cancel the Kitchen Timer before the set time has run out

Press **TIMER ON/OFF**. The display will return to the time of day.

**TIMER ON/OFF**



# Setting Wall Oven Controls

## Consumer Defined Controls

Note: The Consumer Defined Control features are adjustments to the control that will not affect cooking results. These include the Oven Lockout, Silent Control Operation and Temperature Display features.

### Setting Oven Lockout Feature

The  pad controls the Oven Lockout feature. The Oven Lockout feature automatically locks the oven door and prevents the Oven from being turned on. It does not disable the clock, Kitchen Timer or the interior oven lights.

#### INSTRUCTIONS

#### PRESS

#### DISPLAY

#### To activate the Oven Lockout feature

1. Press and hold  for 3 seconds (Figure 1).
2. After 3 seconds "LOC" will appear, a beep will sound and "DOOR LOCKED" will flash in the display. Once the oven door is locked the "DOOR LOCKED" indicator will stop flashing and remain on along with the "LOC".

 for 3 seconds

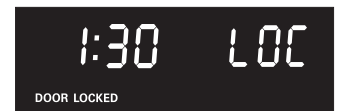



Figure 1

#### To reactivate normal oven operation:

1. Press and hold  for 3 seconds. A beep will sound. "LOC" will disappear and "DOOR LOCKED" will flash in the display until the oven door has completely unlocked (figure 2).
2. The wall oven is again fully operational.



 for 3 seconds



Figure 2

## Setting Silent Control Operation

The **START TIME**  and **CLEAN**  pads control the Silent Control operation feature. The Silent Control operation feature allows the oven control to be operated without sounds or beeps whenever necessary. If desired the control can be programmed for silent operation and later returned to operating with all the normal sounds and beeps.

#### INSTRUCTIONS

#### PRESS

#### DISPLAY

#### To change control from normal sound operation to silent control operation



1. To tell if your range is set for normal or silent operation press and hold . "0:00" will appear and "DELAY" will flash in the display (Figure 3). After 7 seconds ":SP" will appear in the display (Figure 4).
2. Press  to switch between normal sound operation and silent operation mode. The display will show either ":SP" (Figure 4) or ":-" (Figure 5).





Figure 3



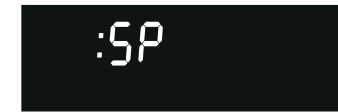



Figure 4

If ":SP" appears (Figure 4), the control will operate with normal sounds and beeps. If ":-" appears (Figure 5), the control is in the silent operation mode.



Figure 5

3. Press  to accept the change or press  to reject the change.

 or 

# Setting Wall Oven Controls



## Consumer Defined Controls (continued)

### Setting Temperature Display — Fahrenheit or Celsius:

The **BROIL** (Broil) and **CLEAN** (Clean) pads control the Fahrenheit or Celsius temperature display modes. The oven control can be programmed to display temperatures in Fahrenheit or Celsius. The oven has been preset at the factory to display in Fahrenheit.

#### INSTRUCTIONS

#### To change display from Fahrenheit to Celsius or Celsius to Fahrenheit

1. To tell if the display is set for Fahrenheit or Celsius press (Broil) (Figure 1) and hold for 7 seconds; "550°" will appear and "BROIL" will flash in the display and a beep will sound. If "F" appears, the display is set to show temperatures in Fahrenheit (Figure 2). If "C" appears, the display is set to show temperatures in Celsius (Figure 3).
2. Press (Clean) to switch between Fahrenheit or Celsius display modes. The display will show either "F" (Figure 2) or "C" (Figure 3).
3. Press (START) to accept the change or press (Clear/Off) to reject the change.

#### PRESS



for 7seconds



#### DISPLAY

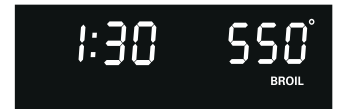

Figure 1



Figure 2



Figure 3







# Setting Wall Oven Controls

## Setting Preheat

The **PREHEAT**  pad controls the Preheat feature. The Preheat feature will bring the oven up to temperature and then indicate when to place the food in the oven. Use this feature when recipes call for preheating. Preheating is not necessary when roasting or cooking casseroles. The oven can be programmed to preheat at any temperature between 170°F to 550°F.

### INSTRUCTIONS

#### To set the Preheat temperature for 350°F







1. Arrange the interior oven racks.
2. Press . " - - - " and "BAKE" will appear in the display (Figure 1).
3. Press   . "350°" and "BAKE" will appear in the display (Figure 2).
4. Press . "PRE" and "BAKE" will appear in the display as the oven heats and reaches 350°F (Figure 3).

Note: After the oven has reached the desired temperature (this example, 350°F) the control will beep and the "PRE" light will turn off and oven temperature will be displayed (Figure 4). If you missed hearing the beep, you can tell that the oven has reached preheat temperature if you see the oven temperature showing in the oven display. Once the oven has preheated, **PLACE FOOD IN THE OVEN**. The "BAKE" light will stay on.

Press  when baking is complete or to cancel the preheat feature.

#### To change Preheat temperature while oven is preheating (example: changing from 350°F to 425°F)

If it is necessary to change the preheat temperature while the oven is preheating to the original temperature:

1. While preheating, press . " - - - " and "BAKE" will appear in the display (Figure 5)
2. Enter the new preheat temperature. Press   . "425°" and "BAKE" will appear in the display (Figure 6).
3. Press . "PRE" and "BAKE" will appear in the display as the oven heats to 425°F (Figure 7). A beep will sound once the oven temperature reaches 425°F and the display will show "425°" and "BAKE" (Figure 8).
4. When baking is complete press .

### PRESS



### DISPLAY



Figure 1

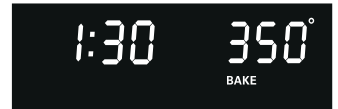

Figure 2



Figure 3



Figure 4



Figure 5



Figure 6



Figure 7



Figure 8

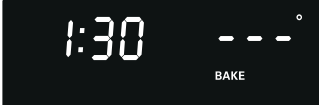
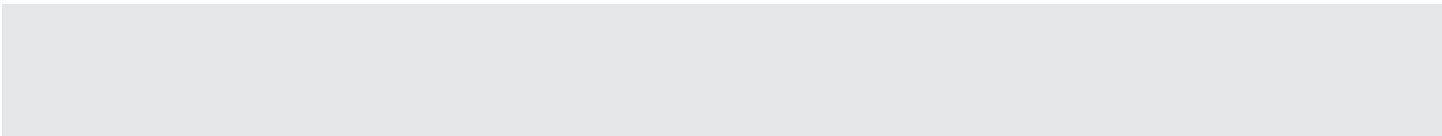







## Setting Wall Oven Controls

### Oven Baking

For best cooking results, heat the oven before baking cookies, breads, cakes, pies or pastries, etc... There is no need to preheat the oven for roasting meat or baking casseroles.

The cooking times and temperatures needed to bake a product may vary slightly from your previously owned appliance.

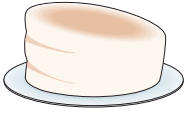
**Baking Problems and Solutions Table**

Baking Problems	Causes	Corrections
<b>Cookies and biscuits burn on the bottom.</b> 	<ul style="list-style-type: none"> <li>• Cookies and biscuits put into the oven before the preheating time is completed.</li> <li>• Oven rack overcrowded.</li> <li>• Dark pan absorbs heat too fast.</li> </ul>	<ul style="list-style-type: none"> <li>• Allow oven to preheat to the selected temperature before placing food in oven.</li> <li>• Choose pan sizes that will permit 5.1 cm to 10.2 cm (2" to 4") of air space on all sides when placed in the oven.</li> <li>• Use a medium-weight aluminum baking sheet.</li> </ul>
<b>Cakes too dark on top or bottom.</b> 	<ul style="list-style-type: none"> <li>• Cakes put into the oven before preheating time is completed.</li> <li>• Rack position too high or low.</li> <li>• Oven too hot.</li> </ul>	<ul style="list-style-type: none"> <li>• Allow oven to preheat to the selected temperature before placing food in the oven.</li> <li>• Use proper rack position for baking needs.</li> <li>• Set oven temperature 25°F/12°C lower than recommended.</li> </ul>
<b>Cakes not done in the center.</b> 	<ul style="list-style-type: none"> <li>• Oven too hot.</li> <li>• Incorrect pan size.</li> <li>• Pan not centered in oven.</li> </ul>	<ul style="list-style-type: none"> <li>• Set oven temperature 25°F/12°C lower than recommended.</li> <li>• Use pan size suggested in recipe.</li> <li>• Use proper rack position and place pan so there is 5.1 cm to 10.2 cm (2" to 4") of space on all sides of pan.</li> </ul>
<b>Cakes not level.</b> 	<ul style="list-style-type: none"> <li>• Range not level.</li> <li>• Pan too close to oven wall or rack overcrowded.</li> <li>• Pan warped.</li> </ul>	<ul style="list-style-type: none"> <li>• Place a marked glass measuring cup filled with water on the center of the oven rack. If the water level is uneven, refer to the installation instructions for leveling the range.</li> <li>• Be sure to allow 5.1 cm to 10.2 cm (2" to 4") of clearance on all sides of each pan in the oven.</li> <li>• Do not use pans that are dented or warped.</li> </ul>
<b>Foods not done when cooking time is up.</b> 	<ul style="list-style-type: none"> <li>• Oven too cool.</li> <li>• Oven overcrowded.</li> <li>• Oven door opened too frequently.</li> </ul>	<ul style="list-style-type: none"> <li>• Set oven temperature 25°F/12°C higher than suggested and bake for the recommended time.</li> <li>• Be sure to remove all pans from the oven except the ones to be used for baking.</li> <li>• Open oven door only after shortest recommended baking time.</li> </ul>



# Setting Wall Oven Controls



## Benefits of Convection Bake:

- Some foods cook up to 30% faster, saving time and energy.
- Multiple rack baking.
- No special pans or bakeware needed.

## Foods for CONVECTION BAKE pad \*Decrease normal cook time by:

Frozen foods, pies, ..... 15-25 % pastries and pizza	
Refrigerator cookies .....	15-35 %
Refrigerator biscuits .....	15-30 %
Rolls & Breads .....	20-25%
Fresh Pies/Pastries .....	10-20 %

Begin with the maximum reduction in cook times and adjust as needed.

\*Recommended reduction in cook times based on brands of food items tested. Cook times may vary with your specific brand of food item.









# Setting Wall Oven Controls

## Setting Convection Roast

The **CONV ROAST**  pad is designed to give optimum cooking performance for this feature. The Convection Roast pad combines a cook cycle with the convection fan and element to roast meats and poultry. Preheating is not necessary for meats and poultry. Heated air circulates around the food from all sides, sealing in juices and flavors. Foods are crispy brown on the outside while staying moist on the inside.

### INSTRUCTIONS

#### To set the Convection Roast feature (example: Meats to cook at 350°F)

1. Arrange interior oven racks and place food in oven.
2. Press . "CONV" will flash and "---°" will be displayed (See Figure 1).
3. Press   . "CONV" will flash and "350°" will appear in the display (See Figure 2).
4. Press . "CONV" and "350°" will appear in the display (See Figure 3). The convection fan icon will come on.

Press  to stop Convection Roast at any time.

### PRESS

### DISPLAY



Figure 1



Figure 2



Figure 3

## Setting Convection Convert feature





The **CONV CONVERT**  pad is used to automatically convert a standard **baking** recipe for convection baking. When set properly, this feature is designed to display the actual converted (reduced) temperature in display.

Convection Convert may **ONLY** be used with a **Bake, Timed Bake** or a **Delay Start** (Delayed Timed Bake) setting. When used with a Timed Bake or a Delayed Timed Bake setting, the Convection Convert feature will display a "CF" for check food when the bake time is 75% complete (See Figure 7). At this time the oven control will sound 3 long beeps at regular intervals until baking has finished. When the bake time has completely finished the control will display "End" and will

sound 3 long beeps every 30 seconds until the  pad is pressed (See Figure 8).

### INSTRUCTIONS

#### Using Convection Convert (Bake) feature to automatically adjust oven temperature (example: setting oven for 350°F):

1. Arrange interior oven racks and place food in oven.
2. Press  , "- - - °" will appear in the display (Figure 4).
3. Press    . "BAKE" will flash and "350°" will appear in the display (See Figure 5). If a Timed Bake or a Delayed Start (Delayed Timed Bake) is desired, enter the times now.
4. Press  . "CONV BAKE" and the oven temperature **adjustment** will appear in the display (for this example it is 325°F). A beep will sound once the **adjusted** oven temperature is reached. The display will show "325°", "CONV BAKE" and the fan icon (Figure 6).

Note: The oven icon will show a rotating fan within the square. This rotating fan icon indicates when the Convection Fan is operating (See rotating fan in Figure 6).

Press  to cancel Convection feature at any time.

**Note:** The minimum amount of cook time using the Convection Convert feature with a **Timed Bake** or a **Delay Start** (Delayed Timed Bake) is 20 minutes.

### PRESS

### DISPLAY



Figure 4



Figure 5



Figure 6



Figure 7

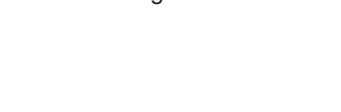

Figure 8

# Setting Wall Oven Controls











## Setting Timed Bake, Timed Convection Bake or Timed Convection Roast

The **BAKE**  or **CONVECTION BAKE**  or **CONVECTION ROAST**  and **BAKE TIME**  pads control the Timed Bake feature. The automatic timer of the Timed Bake feature will turn the oven OFF after cooking for the desired amount of time you selected.

### INSTRUCTIONS

To program the oven to begin baking immediately and to shut off automatically (example: **BAKE** at 350°F for 30 minutes)

1. Be sure the clock is set for the correct time of day.
2. Arrange interior oven rack(s) and place the food in the oven.
3. Press , "--- °" will appear and "**BAKE**" will flash in the display (Figure 1).
4. Press    (Figure 2). "**BAKE**" will continue to flash and "**350°**" will appear in the display.
5. Press . "**BAKE**" and "**350°**" will appear in the display (See Figure 3).
6. Press . "**TIMED**" will flash; "**BAKE**", "**0:00**" and "**350°**" will appear in the display (Figure 4).
7. Enter the desired baking time by pressing  . "**TIMED**" will continue to flash and "**BAKE**", "**30:00**" and "**350°**" will stay in the display (Figure 5). Note: Baking time can be set for any amount of time between 1 minute to 11 hours and 59 minutes.
8. Press . Both the "**TIMED**" and "**BAKE**" icons will remain on in the display (Figure 6). Once the Timed Bake feature has started, the current time of day will appear in the display.

### PRESS

### DISPLAY

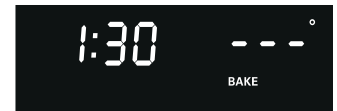

Figure 1

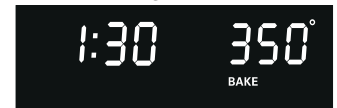

Figure 2



Figure 3



Figure 4



Figure 5



Figure 6

Note: After the Timed Bake feature has activated, press  to display the bake time remaining in the Timed Bake mode. Once Timed Bake has started baking, a beep will sound when the oven temperature reaches the set temperature.

Press  when baking has finished or at any time to cancel the Timed Bake feature.

### When the timed bake finishes:

1. "**End**", "**TIMED**", "**BAKE**" and the time of day will show in display. The oven will shut off automatically (Figure 7).
2. The control will beep 3 times. The control will continue to beep 3 times every 30 seconds until  is pressed.



Figure 7

**NOTE:** Remember that the lowest **BAKE** temperature is 170°F and that the lowest **CONVECTION BAKE** temperature is 325°F.

**CAUTION** Use caution with the **TIMED BAKE** or **DELAYED TIME BAKE** features. Use the automatic timer when cooking cured or frozen meats and most fruits and vegetables. Foods that can easily spoil such as milk, eggs, fish, meat or poultry, should be chilled in the refrigerator first. Even when chilled, they should not stand in the oven for more than 1 hour before cooking begins, and should be removed promptly when cooking is completed. Eating spoiled food can result in sickness from food poisoning.

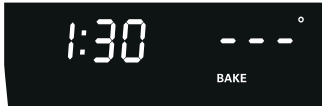
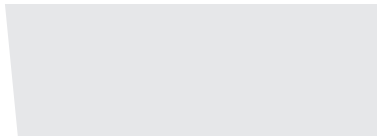

# Setting Wall Oven Controls



## Setting the Keep Warm Feature

The **Keep Warm**  pad turns ON the Keep Warm feature and will maintain an oven temperature of 170°F (77°C). The Keep Warm feature will keep oven baked foods warm for serving up to 3 hours after cooking has finished. After 3 hours the Keep Warm feature will shut the oven OFF. The Keep Warm feature may be used without any other cooking operations or can be used after cooking has finished using BAKE, CONVECTION BAKE or CONVECTION ROAST.

The Keep Warm feature may be used with TIMED BAKE if you wish to have the Keep Warm feature turn ON automatically when cooking has finished. The Timed Bake features require you to set start time and the amount of cooking time. With this information the control can calculate the time when cooking will complete and can then start the Keep Warm feature automatically.

### INSTRUCTIONS

### PRESS

### DISPLAY

#### To set Keep Warm





1. Arrange interior oven racks and place food in oven.
  2. Press . "HLd" will appear in the display (Figure 1).  
**Note:** If no pad is touched within 25 seconds the request to turn ON Keep Warm feature will be cancelled.
  3. Press . The oven icon will appear in the display (Figure 2).
  4. To turn the Keep Warm OFF at any time press  or .
- Note:** The Keep Warm feature will automatically turn OFF after 3 hours.



Figure 1



Figure 2



#### To set Keep Warm to turn ON automatically



1. Arrange interior oven racks and place food in oven. Set the oven properly for **Timed Bake or Delayed Timed Bake**.
  2. Press . (Figure 3)  
**Note:** If no pad is touched within 25 seconds the request to turn ON the Keep Warm feature and all functions previously programmed will be cleared.
  3. Press . "HLd" will disappear and the temperature will be displayed (Figure 4). The Keep Warm mode is set to turn ON automatically after Timed Bake has finished (See Figure 2).
  4. To turn the Keep Warm feature OFF at any time press  again.
- Note:** The Keep Warm feature will automatically turn OFF after 3 hours.



Figure 3



Figure 4



Pressing  at any time will stop all oven baking operations.





# Setting Wall Oven Controls

## Setting Broil

The **Broil** pad controls the Broil feature. When broiling, heat radiates downward from the oven broiler for even coverage. The Broil feature is preset to start broiling at 550°F; however, the Broil feature temperature may be set between 400°F and 550°F. The broil pan and broil pan insert used together allow dripping grease to drain and be kept away from the high heat of the oven broiler. **DO NOT** use the broil pan without the insert (See Figure 5). **DO NOT cover the broil pan insert with foil.** The exposed grease could catch fire.

**⚠ WARNING** Should an oven fire occur, leave the oven door closed and turn off the oven. If the fire continues, throw baking soda on the fire or use a fire extinguisher. **DO NOT** put water or flour on the fire. Flour may be explosive and water can cause a grease fire to spread and cause personal injury.

### INSTRUCTIONS

#### To set the oven to broil at the default setting (550°F):

1. Place the broiler pan insert on the broiler pan. Then place the food on the broiler pan insert. **DO NOT** use the broiler pan without the insert. **DO NOT** cover the broiler insert with foil. The exposed grease could ignite.
2. Arrange the interior oven rack and place the broiler pan on the rack. Be sure to center the broiler pan directly under the broiler element. **Make sure the oven door is in the broil stop position (See Figure 4).**
3. Press **Broil**. "BROIL" will flash and "550°" will appear (Figure 1).
4. If a lower broil temperature is desired (minimum broil temperature setting is 400°F), press the desired temperature before continuing to step 5.
5. Press **START**. The oven will begin to broil. "BROIL" and "550°" will appear in the display (Figure 2).
6. Broil on one side until food is browned; turn and cook on the second side. Season and serve. **Note:** Always pull the rack out to the stop position before turning or removing food.
7. To cancel broiling or if finished broiling press **Clear/Off** (Figure 3).

### PRESS

### DISPLAY

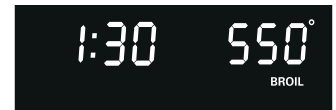

Figure 1



Figure 2



Figure 3

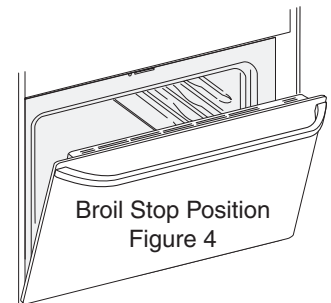

Broil Stop Position  
Figure 4

## Broiling Times

Use the following table for approximate broiling times. Increase or decrease broiling times, or move the broiling pan to a different rack position to suit for doneness. If the food you are broiling is not listed in the table, follow the instructions provided in your cookbook and watch the item closely.

### Electric Range Broiling Table Recommendations

Food Item	Rack Position	Temp Setting	Cook Time		Doneness
			1st side	2nd side	
Steak 1" thick	2nd	550° F	6:00	4:00	Rare
	2nd	550° F	7:00	5:00	Medium
Pork Chops 3/4" thick	2nd	550° F	8:00	6:00	Well
Chicken - Bone In	3rd	450° F	20:00	10:00	Well
Chicken - Boneless	2nd	450° F	8:00	6:00	Well
Fish	2nd	500° F	13:00	n/a	Well
Shrimp	3rd	550° F	5:00	n/a	Well
Hamburger 1" thick	2nd	550° F	9:00	7:00	Medium
	3rd	550° F	10:00	8:00	Well

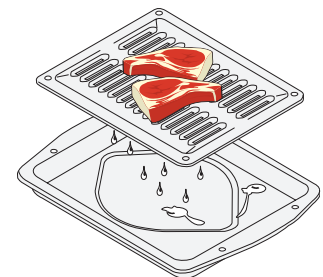
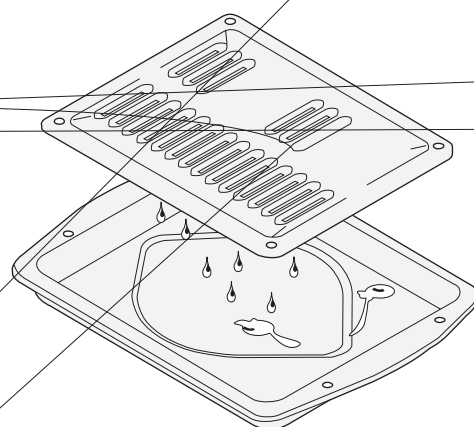

Figure 5



## Setting Wall Oven Controls









# Setting Wall Oven Controls

## To Set the Sabbath Feature (for use on the Jewish Sabbath & Holidays)

The **BAKE TIME**  and **START TIME**  pads are used to set the Sabbath feature. The Sabbath feature may only be used with the  pad. The oven temperature may be set higher or lower after setting the Sabbath feature (the oven temperature adjustment feature should be used only during Jewish Holidays), however the display will not visibly show or provide any audible tones indicating whether the change occurred correctly. Once the oven is properly set using Bake with the Sabbath feature active, the oven will remain continuously ON until cancelled. This will override the factory preset 12-Hour Energy Saving feature.

If the oven light will be needed during the Sabbath, press  before activating the Sabbath feature. Once the oven light is turned ON and the Sabbath feature is active, the oven light will remain ON until the Sabbath feature is turned OFF. If the oven light needs to be OFF, be sure to turn the oven light OFF before activating the Sabbath feature.







**IMPORTANT NOTES:** It is not advised to attempt to activate any other program feature other than **BAKE** while the Sabbath feature is active. **ONLY** the following key pads will function after setting the Sabbath feature:  to , ,  & . **ALL OTHER KEYPADS** will not function once the Sabbath feature is properly activated.

### INSTRUCTIONS

### PRESS

### DISPLAY

## To Program the Oven to Begin Baking Immediately & activate the Sabbath feature (example: baking at 350°F)

1. Be sure that the clock is set with the correct time of day.
2. Place the food in the oven.
3. Press . " — — — ° " appears in the display (Figure 1).
4. Within 5 seconds, press the , ,  (Figure 2). The display will show "350°F (177°C)."
5. Press  (Figure 3).
6. If you desire to set the oven control for a **Timed Bake** or **Delayed Start Bake** do so at this time. If not, skip this step and continue to step 7. Refer to the **Timed Bake** (complete steps 6-8) / **Delayed Start Bake** (complete steps 6-9) section for complete instructions. Remember the oven will shut down after using **Timed Bake** or **Delay Start Bake** and therefore may only be used once during the Sabbath/Jewish Holidays. The maximum **Delayed Start Bake** time is 11 hours & 59 minutes.
7. The oven will turn ON and begin heating.
8. Press and hold both the  and  pads for at least 3 seconds. **SAb** will appear in the display (Figure 4). Once SAb appears in the display the oven control will no longer beep when a keypad is pressed or display any further changes. The oven is properly set for the Sabbath feature.

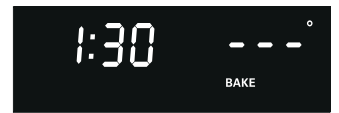

Figure 1

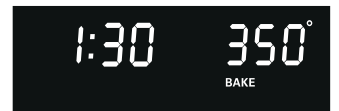

Figure 2



Figure 3



Figure 4



# Setting Wall Oven Controls











## To Set the Sabbath Feature (for use on the Jewish Sabbath & Holidays)

### INSTRUCTIONS

### PRESS

### DISPLAY

**Note:** You may change the oven temperature once baking has started by pressing , the numeric key pads for the temperature you want (example for 425°C press , , ) and then pressing  TWICE (for Jewish Holidays only). Remember that **the oven control will no longer beep when a keypad is pressed or display any further changes** once the oven is set for the Sabbath feature.

9. The oven may be turned OFF at any time by first pressing  pad (this will turn the oven OFF only). To turn OFF the Sabbath feature press and hold both the  and  pads for at least 3 seconds. This also turns off the oven. **SAb** will disappear from the display (Figure 1).

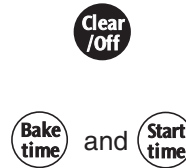



Figure 1

Should you experience a power failure or interruption, the oven will shut off. When power is returned the oven will not turn back on automatically. The oven will remember that it is set for the Sabbath and the food may be safely removed from the oven while still in the Sabbath feature, however the oven cannot be turned back on until after the Sabbath. After the Sabbath observance turn OFF the Sabbath feature. Press and hold both the  and  pads for at least 3 seconds. **SAb** will disappear from the display and the oven may be used with all normal functions. For further assistance, guidelines for proper usage, and a complete list of models with the Sabbath feature, please visit the web at <http://www.star-k.org>.

## Wall Oven Self-Cleaning Cycle

**CAUTION** During the self-cleaning cycle, the outside of the oven can become very hot to the touch. **DO NOT** leave small children unattended near the appliance.

**CAUTION** The health of some birds is extremely sensitive to the fumes given off during the self-clean cycle of any wall oven. Move birds to another well ventilated room.

**CAUTION** **DO NOT** line the oven walls, racks, bottom or any other part of the appliance with aluminum foil. Doing so will destroy heat distribution, produce poor baking results and cause permanent damage to the interior (aluminum foil will melt to the interior surface of the oven).

**CAUTION** **DO NOT** force the oven door open. This can damage the automatic door locking system. Use caution when opening the door after the Self-Cleaning cycle is completed. The oven may still be **VERY HOT**.

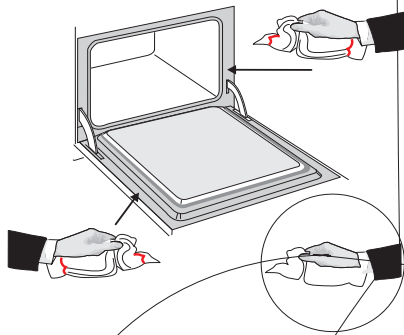

### Self-Cleaning Oven

A Self-Cleaning oven cleans itself with high temperatures (well above cooking temperatures) which eliminate soils completely or reduces them to a fine powdered ash you can wipe away with a damp cloth.

#### Adhere to the following cleaning precautions:

- Allow the oven to cool before cleaning.
- Wear rubber gloves when cleaning any exterior parts of the oven manually.
- **DO NOT** clean the oven door gasket. The woven material of the oven door gasket is essential for a good seal. Care should be taken not to rub, damage or remove the gasket.
- **DO NOT** use any cleaning materials on the oven door gasket. Doing so could cause damage.
- **Remove the broiler pan and insert, all utensils and any aluminum foil. These items cannot withstand high cleaning temperatures.**
- This oven comes with lubricated porcelain oven racks, which can remain in the oven during the self-clean cycle. Do not clean this vegetable oil lubrication off the racks. It is important that the sides of the oven racks always have a light coating of vegetable oil. To maintain optimal rack performance, re-apply a thin layer of vegetable oil to the sides of the rack after every self-clean cycle or when the rack becomes difficult to slide.
- **Remove any excessive spillovers** in the oven cavity **before** starting the Self-Cleaning cycle. To clean, use hot, soapy water and a cloth. Large spillovers can cause heavy smoke or fire when subjected to high temperatures. **DO NOT** allow food spills with a high sugar or acid content (such as milk, tomatoes, sauerkraut, fruit juices or pie filling) to remain on the surface as they may leave a dull spot even after cleaning.
- Clean any soil from the oven frame, the door liner outside the oven door gasket and the small area at the front center of the oven bottom. These areas heat sufficiently to burn soil on. Clean with soap and water.

**NOTE:** Prior to setting the Self-Clean cycle, any spills remaining on the oven bottom should be removed.

Some models have an exposed Bake element in the wall oven cavity. On these models the bake element is designed to be tilted up using your hand from the front of the bake element. This will allow easier access to the oven bottom for cleaning. Be careful not to raise the element more than 4 or 5 inches from the resting position.

#### What to Expect during Cleaning:

While the oven is in operation, the oven heats to temperatures much higher than those used in normal cooking. Sounds of metal expansion and contraction are normal. Odor is also normal as the food soil is being removed. Smoke may appear through the oven vent.



If heavy spillovers are not wiped up before cleaning, they may flame and cause more smoke and odor than usual. This is normal and safe and should not cause alarm. If available, use an exhaust fan during the self-cleaning cycle.



**NOTE:** A smoke eliminator in the oven vent converts most of the smoke into a colorless vapor.

# Wall Oven Self-Cleaning Cycle

Clean





## Self-Clean Cycle Time Length

The **SPEED CLEAN** , **CLEAN**  and **MAXX CLEAN**  pads control the Self-Cleaning feature. If you are planning to use the oven directly after a self-clean cycle remember to allow time for the oven to cool down and the oven door to unlock. This normally takes about one hour. So a 3 hour self-clean cycle will actually take about 4 hours to complete.

\*It is recommend to use a  cycle (2 hour) for **light soils**, a  cycle (3 hour) for **average soils**, and a  cycle (4 hour) for **heavy soils** (to assure satisfactory results).

## INSTRUCTIONS

### To set the controls for a 3 hour Self-Cleaning cycle to start immediately and shut off automatically

1. Be sure the clock is set with the correct time of day and the oven door is closed.
2. Press . "CLEAN" will flash and "3:00" HR will show in the display (Figure 1). The control will automatically clean for a 3 hour period (default self-cleaning cycle time). Note: If a 2 or 4 hour clean time is desired, press  for 2 hour or press  for a 4 hour clean time. Set the cleaning time based on the amount of soil: light, medium or heavy (\* See above).
3. Press . The "DOOR LOCKED" icon will flash; "CLEAN" icon and the letters "CLn" will remain on in the display (Figure 2).
4. As soon as the control is set, the motor driven oven door lock will begin to close automatically. Once the door has been locked the "DOOR LOCKED" indicator light will stop flashing and remain on. Also, the oven icon will appear in the display (Figure 3).

Note: Allow about 15 seconds for the oven door lock to close.

### When the Self-Clean Cycle is Completed

1. The time of day, "END", "DOOR LOCKED" and "CLEAN" will remain in the display (Figure 4).
2. Once the oven has cooled down for approximately 1 HOUR, and "DOOR LOCKED" is no longer displayed, the oven door can then be opened (Figure 5).

### Stopping or Interrupting a Self-Cleaning Cycle

If it becomes necessary to stop or interrupt a self-cleaning cycle due to excessive smoke or fire in the oven:

1. Press .
2. The oven door can only be opened after the oven has cooled down for approximately 1 HOUR and "DOOR LOCKED" is no longer displayed (Figure 5).

**CAUTION** To avoid possible burns use care when opening the oven door after the Self-Cleaning cycle. Stand to the side of the oven when opening the door to allow hot air or steam to escape.

**CAUTION DO NOT** force the oven door open. This can damage the automatic door locking system. Use caution and avoid possible burns when opening the door after the Self-Cleaning cycle has completed. The oven may still be VERY HOT.

## PRESS

## DISPLAY



Figure 1



Figure 2



Figure 3



Figure 4



Figure 5





# Wall Oven Self-Cleaning Cycle

## To Start the delayed Self-Clean Cycle

The **SPEED CLEAN** (Speed clean), **CLEAN** (Clean), **MAXX CLEAN** (Maxx clean) and **START TIME** (Start time) pads controls the Delayed Self-Clean operation. The automatic timer will turn the oven **on and off** at the time you select in advance. Be sure to review **TO START THE SELF-CLEAN CYCLE** for recommended clean times.

### INSTRUCTIONS

#### To set the control for the Self-Cleaning Cycle to start at a delayed time and shut off automatically (example: 3 hour self-clean cycle to start at 4:30)

1. Be sure the clock is set with the correct time of day and the oven door is closed.
2. Press **Clean**. "**CLEAN**" will flash and "**3:00**" HR will show in the display (Figure 1). The control will automatically clean for a 3 hour period (default self-cleaning cycle time). Note: If a 2 or 4 hour clean time is desired, press **Speed clean** for 2 hour or press **Maxx clean** for a 4 hour clean time. Set the cleaning time based on the amount of soil—light, medium or heavy (\*See previous page).
3. Press **START**. The "**DOOR LOCKED**" icon will flash; "**CLEAN**" icon and the letters "**CLn**" will remain on in the display (Figure 2).
4. As soon as the control is set, the motor driven oven door lock will begin to close automatically. Once the door has been locked the "**DOOR LOCKED**" indicator light will quit flashing and remain on.
5. Press **Start time**. Enter the desired start time using the number pads **4** **3** **0** (Figure 3).
6. Press **START**. The "**CLn**" icon will turn off; "**DELAY**", "**DOOR LOCKED**" and "**CLEAN**" icons will remain on (Figure 4).
7. The control will start the self-cleaning at the set start time, for the period of time previously selected. At that time, the icon "**DELAY**" will go out; "**CLn**" and oven icon will appear in the display (Figure 5).

#### When the Self-Clean Cycle is Completed

1. The time of day, "**END**", "**DOOR LOCKED**" and "**CLEAN**" will remain in the display (Figure 6).
2. Once the oven has cooled down for approximately 1 HOUR, and "**DOOR LOCKED**" is no longer displayed, the oven door can then be opened (Figure 7).

#### Stopping or Interrupting a Self-Cleaning Cycle

If it becomes necessary to stop or interrupt a self-cleaning cycle due to excessive smoke or fire in the oven:

1. Press **Clear /Off**.
2. Once the oven has cooled down for approximately 1 HOUR and "**DOOR LOCKED**" is no longer displayed, the oven door can then be opened (Figure 8).

Note: Self-Clean cycle can never be set to start more than 12 hours in advance.

### PRESS

### DISPLAY



Figure 1



Figure 2

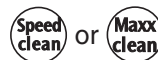

Figure 3



Figure 4



Figure 5



Figure 6



Figure 7

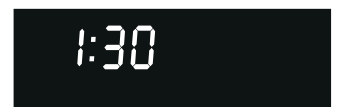

Figure 8

# Microwave Oven Care & Cleaning



## Cleaning Various Parts of Your Microwave Oven

Before cleaning any part of the oven, be sure all controls are turned OFF and the oven is COOL. REMOVE SPILLOVERS AND HEAVY SOILING AS SOON AS POSSIBLE. REGULAR CLEANINGS NOW WILL REDUCE THE EXTENT AND DIFFICULTY OF MAJOR CLEANING LATER.

Surfaces	How to Clean
<b>Door</b>	Wipe the window on both sides with a damp cloth to remove any spills or spatters. Metal parts will be easier to maintain if wiped frequently with a damp cloth. Cleaners which are marked specifically for use with stainless steel may be used. Follow package directions exactly. Avoid the use of any harsh cleaner or one not marked for stainless steel use as they may stain, streak or dull the door surface.
<b>Touch Control Panel</b>	Care should be taken in cleaning the touch control panel. If the control panel becomes soiled, open the microwave oven door before cleaning. Wipe the panel with a cloth dampened slightly with water only. Dry with a soft cloth. Do not scrub or use any sort of chemical cleaners. Close door and touch <b>Clear/Off</b> .
<b>Interior</b>	Cleaning is easy because little heat is generated to the interior surfaces; therefore, there is no baking and setting of spills or spattering. To clean the interior surfaces, wipe with a soft cloth and warm water. DO NOT USE ABRASIVE OR HARSH CLEANERS OR SCOURING PADS. For heavier soil, use baking soda or a mild soap; rinse thoroughly with hot water.
<b>Waveguide Cover</b>	The waveguide cover is located on the ceiling in the microwave oven cavity. It is made from mica so it requires special care. Keep the waveguide cover clean to assure good microwave oven performance. Carefully wipe with a damp cloth any food spatters from the surface of the cover immediately after they occur. Built-up splashes may overheat and cause smoke or possibly catch fire. DO NOT REMOVE THE WAVEGUIDE COVER.
<b>Odor Removal</b>	Occasionally, a cooking odor may remain in the microwave oven. To remove, combine 1 cup water, grated peel and juice of 1 lemon and several whole cloves in a 2-cup glass measuring cup. Boil for several minutes using 100% power. Allow to set in microwave oven until cool. Wipe interior with a soft cloth.
<b>Turntable / Turntable Support</b>	The turntable and turntable support can be removed for easy cleaning. Wash them in mild, sudsy water; for stubborn stains use a mild cleanser and non abrasive scouring sponge. They may also be dishwasher cleaned. Clean the turntable support in upper rack of dishwasher. The turntable motor shaft is not sealed, so excess water or spills should be wiped up immediately.



## Wall Oven Care & Cleaning

### Cleaning Various Parts of Your Wall Oven

Before cleaning any part of the oven, be sure all controls are turned OFF and the oven is COOL. REMOVE SPILLOVERS AND HEAVY SOILING AS SOON AS POSSIBLE. REGULAR CLEANINGS NOW WILL REDUCE THE EXTENT AND DIFFICULTY OF MAJOR CLEANING LATER.

Surfaces	How to Clean
<b>Aluminum (Trim Pieces) &amp; Vinyl</b>	Use hot, soapy water and a cloth. Dry with a clean cloth. Do not scour or use all-purpose cleaners, ammonia, powdered cleaners or commercial oven cleaner. They can scratch and discolor aluminum.
<b>Painted and Plastic Control Panel, Body Parts, and Decorative Trim</b>	<p><i>For general cleaning</i>, use hot, soapy water and a cloth. <i>For more difficult soils and built-up grease</i>, apply a liquid detergent directly onto the soil. Leave on soil for 30 to 60 minutes. Rinse with a damp cloth and dry. <b>DO NOT</b> use abrasive cleaners on any of these materials; they can scratch.</p> <p>To remove control knobs, turn to the OFF position; grasp firmly and pull straight off the shaft. To replace knobs after cleaning, line up the flat sides of both the knob and the shaft; then push the knob into place.</p>
<b>Stainless Steel, Chrome Control Panel, Decorative Trim</b>	<p><i>Before cleaning the control panel</i>, turn all controls to OFF and remove the control knobs. To remove, pull each knob straight off the shaft. Clean using hot, soapy water and a dishcloth. Rinse with a clean water using a dishcloth. Be sure to squeeze excess water from the cloth before wiping the panel; especially when wiping around the controls. Excess water in or around the controls may cause damage to the appliance. To replace knobs after cleaning, line up the flat sides of both the knob and the shaft; then push the knob into place.</p> <p>Clean <b>stainless steel</b> with hot, soapy water and a dishcloth. Rinse with clean water and a cloth. <b>Do not use cleaners with high concentrations of chlorides or chlorines.</b> Do not use harsh scrubbing cleaners. Only use kitchen cleaners that are especially made for cleaning stainless steel. Always be sure to rinse the cleaners from the surface as bluish stains may occur during heating that cannot be removed.</p>
<b>Porcelain Enamel Broiler Pan and Insert, Door Liner, Body Parts</b>	Gentle scouring with a soapy scouring pad will remove most spots. Rinse with a 1:1 solution of clear water and ammonia. <i>If necessary</i> , cover difficult spots with an ammonia-soaked paper towel for 30 to 40 minutes. Rinse with clean water and a damp cloth, and then scrub with a soap-filled scouring pad. Rinse and wipe dry with a clean cloth. Remove all cleaners or the porcelain may become damaged during future heating. <b>DO NOT</b> use spray oven cleaners on the cooktop.
<b>Oven Racks</b>	<p>This oven comes with lubricated porcelain oven racks, which can remain in the oven during the self-clean cycle. Do not clean this vegetable oil lubrication off the racks. It is important that the sides of the oven racks always have a light coating of vegetable oil. To maintain optimal rack performance, re-apply a thin layer of vegetable oil to the sides of the rack after every self-clean cycle or when the rack becomes difficult to slide.</p> <p>For some models with chrome oven racks, clean by using a mild, abrasive cleaner following manufacturer's instructions. Rinse with clean water and dry.</p>
<b>Oven Door</b>	<p>Use soap &amp; water to thoroughly clean the top, sides and front of the oven door. Rinse well. You may use a glass cleaner on the outside glass of the oven door. <b>DO NOT</b> immerse the door in water. <b>DO NOT spray or allow water or the glass cleaner to enter the door vents.</b> DO NOT use oven cleaners, cleaning powders or any harsh abrasive cleaning materials on the outside of the oven door.</p> <p><b>DO NOT</b> clean the oven door gasket. The oven door gasket is made of a woven material, on Self-Cleaning models, which is essential for a good seal. Care should be taken not to rub, damage or remove this gasket.</p>

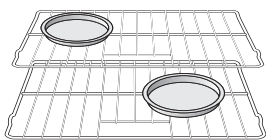

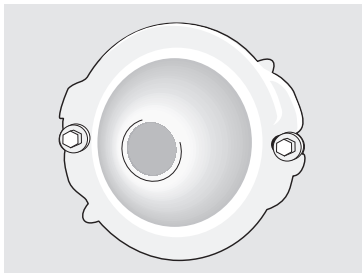
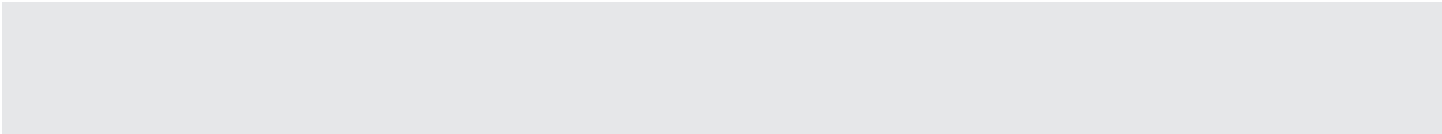



## Wall Oven Care & Cleaning

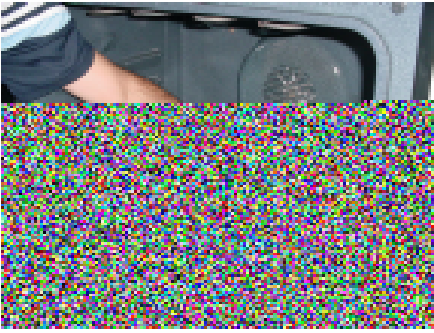

### To Remove the “Hidden Bake” Cover

1. In order to remove the “hidden bake” cover, pull the back edge with one hand about 1/2" inch and lift up the “hidden bake” cover with both hands. (See picture)
2. When re-installing the “hidden bake” cover, be sure to put it all the way to the back of the oven and lay it down on the 2 shoulder screws. Then push the front edge of the cover in its place below the front bracket.

To have easier access to the "hidden bake" cover, first remove the oven door by following the instructions above.

**IMPORTANT:** Always replace the “hidden bake” cover before the next use.



# *Adjusting Your Oven Temperature*





## ***Before you call*** *Solutions to Common Problems*

**Before you call for service**, review this list. It may save you time and expense. The list includes common occurrences that are not the result of defective workmanship or materials in this appliance.

<b>OCCURRENCE</b>	<b>POSSIBLE CAUSE/SOLUTION</b>
<b>Control pads for Sensor Cooking, One-Touch Cooking, and Defrost will not operate.</b>	The oven door was opened and closed without initiating a cooking cycle within three minutes. Touch <b>CLEAR/OFF</b> to resume normal pad operation.
<b>Microwave oven light does not come on. Cooling fan does not work. Turntable does not rotate.</b>	If one of those situation appear please check the electrical outlet, fuse and/or circuit breaker. If they are functioning properly, contact your nearest Electrolux Authorized Servicer. A microwave oven should never be serviced by a "do-it-yourself" repair person.
<b>Water in a cup in microwave does not warm.</b>	If this situation appears please check the electrical outlet, fuse and/or circuit breaker. If they are functioning properly, contact your nearest Electrolux Authorized Servicer. A microwave oven should never be serviced by a "do-it-yourself" repair person.
<b>Time appearing in the display is counting down very rapidly.</b>	Please check Demonstration Mode on page 16 and cancel.
<b>Wall Oven Control Beeps and Displays any F code error (example F11).</b>	Electronic control has detected a fault condition. Press <b>CLEAR/OFF</b> to clear the display and stop the beeping. Reprogram the oven. If a fault reoccurs, record the fault number. Press <b>CLEAR/OFF</b> and call Electrolux or another qualified servicer.
<b>-dr- is displayed.</b>	The door was left open and controls set for self-cleaning cycle. Close the door and push <b>CLEAR/OFF pad</b> .
<b>Installation.</b>	Place oven rack in center of oven. Place a level on the oven rack. Contact installing agent if rack and cabinet cutout flooring are not level.  Kitchen cabinet misalignment may make oven appear to be not level. Be sure cabinets are square and level. Contact cabinet maker to correct problem.
<b>Entire Wall oven does not operate.</b>	When the oven is first plugged in, or when the power supply to the oven has been interrupted, the display will flash. The oven cannot be programmed until the clock is set.  Be sure electrical cord is securely connected into the electrical junction box.  Cord/plug is not installed and/or connected. Cord is not supplied with oven. Contact Electrolux or another qualified servicer.  Service wiring not complete. Contact Electrolux or another qualified servicer.  Power outage. Check house lights to be sure. Call your local electric company.  Short in cord/plug. Replace cord/plug.  Controls are not set properly. See instructions under <b>Setting Oven Controls</b> to set the controls.  House fuse has blown or circuit breaker has tripped immediately following installation. House fuse may not be fully engaged. Check fuse and screw or engage circuit breaker securely.  House fuse has blown or circuit breaker has tripped after the oven has been installed and previously operating. Call Electrolux or another qualified servicer.

## ***Before you call*** *Solutions to Common Problems*



<b>OCCURRENCE</b>	<b>POSSIBLE CAUSE / SOLUTION</b>
<b>Wall oven light does not work.</b>	Burned-out or loose bulb. Follow the instructions under <b>Changing Oven Light</b> to replace or tighten the bulb.
<b>Wall oven fan noise during cooking operation.</b>	A cooling fan may automatically turn on and off to cool internal parts. This is normal, and the fan may continue to run even after oven is turned off.
<b>Oven smokes excessively during broiling.</b>	Oven door is closed. Door should be open during broiling.  Meat too close to the broiler unit. Reposition the rack to provide more clearance between the meat and the broiler. Preheat broil element for quick searing operation.  Meat not properly prepared. Remove excess fat from meat. Slash remaining fatty edges to prevent curling, but do not cut into the lean.  Grid on broiler pan wrong side-up. Grease does not drain into broiler pan. Always place the grid on the broiler pan with the ribs up and the slots down to allow grease to drip into the pan.  Broiler pan used without grid or grid cover with foil. <b>DO NOT</b> use the broiler pan without the grid or cover the grid with foil.  Oven needs to be cleaned. Grease has built up on oven surfaces. Regular cleaning is necessary when broiling frequently. Old grease or food spatters cause excessive smoking.
<b>Poor baking results.</b>	Many factors affect baking results. See <b>Oven Baking</b> for hints, causes and corrections. See <b>Adjusting Oven Temperature</b> .
<b>Self-cleaning cycle does not work.</b>	Make sure the oven door is closed.  Controls not set properly. Follow instructions.  Self-cleaning cycle was interrupted. Stop time must be set 2-4 hours past the start time. Follow steps under "Stopping or Interrupting a Self-Cleaning Cycle" in this Use & Care Guide.
<b>Soil not completely removed after self-cleaning cycle is completed.</b>	Failure to clean bottom, from top of oven, frame of oven or door area outside oven seal. These areas are not in the self-cleaning area, but get not enough to burn on residue. Clean these areas before the self-cleaning cycle is started. Burned on residue can be cleaned with a stiff nylon brush and water or a nylon scrubber. Be careful not to damage the oven gasket.  Excessive spillovers in oven. Set the self-clean cycle for longer cleaning time.
<b>Flames inside oven or smoke from vent.</b>	Excessive spillovers in oven. This is normal, especially for high oven temperatures, pie spillovers or for large amounts of grease on bottom of oven. Wipe up excessive spillovers.



# LIMITED WARRANTY

Your Microwave / Wall Oven Combination is protected by this warranty

	WARRANTY PERIOD	THROUGH OUR AUTHORIZED SERVICERS WE WILL:	THE CONSUMER WILL BE RESPONSIBLE FOR:
<b>FULL ONE-YEAR WARRANTY</b>	One year from original purchase date.	Pay all costs for repairing or replacing any parts of this appliance which prove to be defective in materials or workmanship.	Costs of service calls that are listed under <b>NORMAL RESPONSIBILITIES OF THE CONSUMER.*</b>
<b>LIMITED 2ND YEAR WARRANTY (Microwave Oven)</b>	Two years from original purchase date	Repair or replace any part of the microwave oven which proves to be defective in materials or workmanship.	Cost of shipping the replacement part to the nearest authorized servicer; and all labor and service charges.
<b>LIMITED 2ND-10TH YEAR WARRANTY (Magnetron Tube)</b>	Second through tenth years from original purchase date.	Provide a replacement for any magnetron tube which proves to be defective in workmanship or material.	Cost of shipping the replacement part to the nearest authorized servicer; and all labor and service charges.
<b>LIMITED WARRANTY (Applicable to the State of Alaska)</b>	Time periods listed above.	All of the provisions of the full and limited warranties above and the exclusions listed below apply.	Costs of the technician's travel to the home and any costs for pick up and delivery of the appliance required because of service.

In the U.S.A., your appliance is warranted by Electrolux Home Products, Inc. In Canada, your appliance is warranted by Electrolux Canada Corp. We authorize no person to change or to add to any of our obligations under this warranty. Our obligations for service and parts under this warranty must be performed by us or an authorized servicer.

### \* NORMAL RESPONSIBILITIES OF THE CONSUMER

**This warranty applies only to products in ordinary household use, and the consumer is responsible for the items listed below:**

1. Proper use of the appliance in accordance with instructions provided with the product.
2. Proper installation by an authorized servicer in accordance with instructions provided with the appliance and in accordance with all local plumbing, electrical and/or gas codes.
3. Proper connection to a grounded power supply of sufficient voltage, replacement of blown fuses, repair of loose connections or defects in house wiring.
4. Expenses for making the appliance accessible for servicing, such as removal of trim, cupboards, shelves, etc., which are not a part of the appliance when it was shipped from the factory.
5. Damages to finish after installation.
6. Replacement of light bulbs and/or fluorescent tubes (on models with these features).

### EXCLUSIONS

**This warranty does not cover the following:**

1. CONSEQUENTIAL OR INCIDENTAL DAMAGES SUCH AS PROPERTY DAMAGE AND INCIDENTAL EXPENSES RESULTING FROM ANY BREACH OF THIS WRITTEN OR ANY IMPLIED WARRANTY.  
*Note: Some states do not allow the exclusion or limitation of incidental or consequential damages, so this limitation or exclusion may not apply to you.*
2. Service calls which do not involve malfunction or defects in workmanship or material, or for appliances not in ordinary household use. The consumer shall pay for such service calls.
3. Damages caused by services performed by servicers other than Electrolux Home Products, Inc., Electrolux Canada Corp., or their authorized servicers; use of parts other than genuine Electrolux parts; obtained from persons other than such servicers; or external causes such as abuse, misuse, inadequate power supply or acts of God.
4. Products with original serial numbers that have been removed or altered and cannot be readily determined.

### IF YOU NEED SERVICE

Keep your bill of sale, delivery slip, or some other appropriate payment record. The date on the bill establishes the warranty period should service be required. If service is performed, it is in your best interest to obtain and keep all receipts. This written warranty gives you specific legal rights. You may also have other rights that vary from state to state. Service under this warranty must be obtained by contacting Electrolux Home Products, Inc. or Electrolux Canada Corp.

This warranty only applies in the 50 states of the U.S.A., Puerto Rico, and Canada. Product features or specifications as described or illustrated are subject to change without notice. All warranties are made by Electrolux Home Products, Inc. or Electrolux Canada Corp.

**USA**  
**800•944•9044**  
 Electrolux Home Products, Inc.  
 P.O. Box 212378  
 Augusta, GA 30917

**Canada**  
**866•294•9911 (English or French)**  
 Electrolux Canada Corp.  
 6150 McLaughlin Road  
 Mississauga, Ontario, Canada  
 L5R 4C2

## Free Manuals Download Website

<http://myh66.com>

<http://usermanuals.us>

<http://www.somanuals.com>

<http://www.4manuals.cc>

<http://www.manual-lib.com>

<http://www.404manual.com>

<http://www.luxmanual.com>

<http://aubethermostatmanual.com>

Golf course search by state

<http://golfingnear.com>

Email search by domain

<http://emailbydomain.com>

Auto manuals search

<http://auto.somanuals.com>

TV manuals search

<http://tv.somanuals.com>