

Use & Care Manual

Gas Range

ES510L Control with Speed Bake™ Cooking System,
Self-Cleaning Oven with a
Bake-n-Warm™ Double Oven



Questions or for Service Call:

1-800-944-9044 (U.S.)

1-800-668-4606 (Canada)

Visit the Frigidaire Web Site at: <http://www.frigidaire.com>

Welcome 2



Important Safety Instructions 3-5



Features at a Glance 6



Before Setting Oven Controls 7



Setting Surface Controls 8



Control Pad Features 9



Setting Oven Controls 10-21



Bake-n-Warm™ Double Oven 22-24



Self Cleaning 25-27



Adjusting Oven Temperature 27



Care & Cleaning 28-30



Before You Call

Solutions to Common Problems 31



Warranty Back Page





Welcome & Congratulations

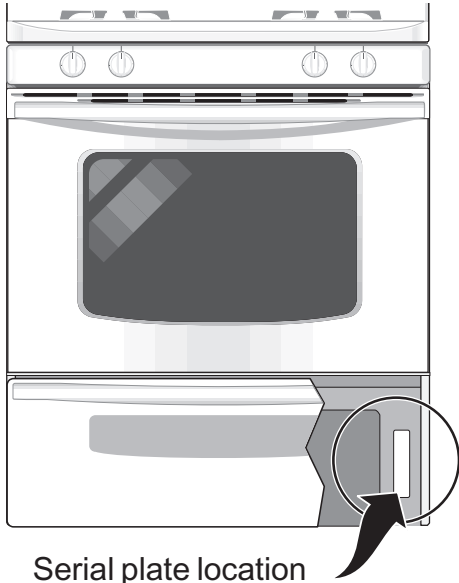

Serial plate location

Open Bake-n-Warm™
Double Oven or Warmer Drawer.

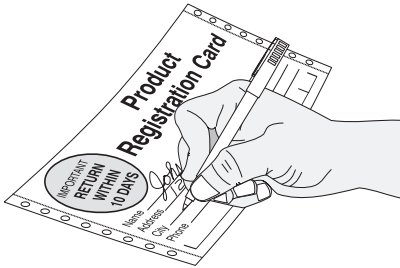

Congratulations on your purchase of a new range! At **Electrolux Home Products**, we are very proud of our product and are completely committed to providing you with the best service possible. Your satisfaction is our number one priority.

We know you'll enjoy your new range and **Thank You** for choosing our product. We hope you consider us for future purchases.

PLEASE CAREFULLY READ AND SAVE THESE INSTRUCTIONS

This Use & Care Manual provides specific operating instructions for your model. Use your range only as instructed in this manual. These instructions are not meant to cover every possible condition and situation that may occur. Common sense and caution must be practiced when installing, operating and maintaining any appliance.

Please record your model and serial numbers below for future reference.

Model Number: _____

Serial Number: _____

Purchase Date: _____

This Use & Care Manual contains general operating instructions for your appliance and feature information for several models. Your range **may not** have all the described features. The graphics shown are representative. The graphics on your range may not look exactly like those shown.

Product Registration

Be sure to register your product. The self-addressed **PRODUCT REGISTRATION CARD** should be filled in completely, signed and returned to Electrolux Home Products.

Important Safety Instructions



Read all instructions before using this appliance. Save these instructions for future reference.

This manual contains important safety symbols and instructions. Please pay attention to these symbols and follow all instructions given.

⚠ WARNING This symbol will help alert you to situations that may cause serious bodily harm, death or property damage.

⚠ CAUTION This symbol will help alert you to situations that may cause bodily injury or property damage.

⚠ WARNING If the information in this manual is not followed exactly, a fire or explosion may result causing property damage, personal injury or death.

FOR YOUR SAFETY:

- Do not store or use gasoline or other flammable vapors and liquids in the vicinity of this or any other appliance.
 - **WHAT TO DO IF YOU SMELL GAS:**
 - Do not try to light any appliance.
 - Do not touch any electrical switch; do not use any phone in your building.
 - Immediately call your gas supplier from a neighbor's phone. Follow the gas supplier's instructions.
 - If you cannot reach your gas supplier, call the fire department.
 - Installation and service must be performed by a qualified installer, servicer or the gas supplier.
-
- **Remove all tape and packaging before using the range.** Destroy the carton and plastic bags after unpacking the range. Never allow children to play with packaging material.
 - **Proper Installation—Be sure your appliance is properly installed and grounded by a qualified technician in accordance with the National Fuel Gas Code ANSI Z223.- latest edition, or in Canada CAN/CGA B149.1, and CAN/CGA B149.2, and the the National Electrical Code ANSI/NFPA No.70-latest edition, or in Canada CSA Standard C22.1, Canadian Electrical Code, Part 1, and local code requirements.** Install only per installation instructions provided in the literature package for this range.
Ask your dealer to recommend a qualified technician and an authorized repair service. Know how to disconnect the power to the range at the circuit breaker or fuse box in case of an emergency.
 - **User servicing—Do not repair or replace any part of the appliance unless specifically recommended in the manuals.** All other servicing should be done only by a qualified technician, This may reduce the risk of personal injury and damage to the range.
 - **Never modify or alter the construction of a range by removing leveling legs, panels, wire covers, anti-tip brackets/screws, or any other part of the product.**

⚠ WARNING

- All ranges can tip.
- Injury to persons could result.
- Install anti-tip device packed with range.
- See Installation Instructions.



⚠ WARNING To reduce the risk of tipping, the range must be secured by properly installed anti-tip bracket provided with the range. To check if the bracket is installed properly, visually check that rear leveling leg is inserted into and fully secured by the anti-tip bracket by removing lower panel or storage drawer. For models with a warmer drawer, grasp the top rear edge of the range and carefully attempt to tilt it forward. Refer to the installation instructions for proper anti-tip bracket installation.

⚠ WARNING NEVER use this appliance as a space heater to heat or warm the room. Doing so may result in carbon monoxide poisoning.

⚠ WARNING NEVER cover any slots, holes or passages in the oven bottom or cover an entire rack with materials such as aluminum foil. Doing so blocks air flow through the oven and may cause carbon monoxide poisoning. Aluminum foil linings may trap heat, causing a fire hazard.

⚠ WARNING Stepping, leaning or sitting on the doors or drawers of this range can result in serious injuries and also cause damage to the range. Do not allow children to climb or play around the range. The weight of a child on an open door may cause the range to tip, resulting in serious burns or other injury.

⚠ WARNING Do not use the oven or Warmer Drawer/ Bake-n-Warm™ Double Oven (if equipped) for storage.

⚠ CAUTION Do not store items of interest to children in the cabinets above a range or on the backguard of a range. Children climbing on the range to reach items could be seriously injured.

• **Storage in or on Appliance—Flammable materials should not be stored in an oven, Warmer Drawer/ Bake-n-Warm™ Double Oven, near surface units or in the storage drawer.** This includes paper, plastic and cloth items, such as cookbooks, plasticware and towels, as well as flammable liquids. Do not store explosives, such as aerosol cans, on or near the range.



Important Safety Instructions

- **Do Not Leave Children Alone**—Children should not be left alone or unattended in the area where appliance is in use. They should never be allowed to sit or stand on any part of the appliance.
- **DO NOT TOUCH SURFACE BURNERS, AREAS NEAR THESE BURNERS, OVEN BURNERS OR INTERIOR SURFACES OF THE OVEN.** Both surface and oven burners may be hot even though flames are not visible. Areas near surface burners may become hot enough to cause burns. During and after use, do not touch, or let clothing or other flammable materials touch these areas until they have had sufficient time to cool. Among these areas are the cook top, surfaces facing the cook top, the oven vent openings and surfaces near these openings, oven door and window.
- **Wear Proper Apparel**—Loose-fitting or hanging garments should never be worn while using the appliance. Do not let clothing or other flammable materials contact hot surfaces.
- **Do Not Use Water or Flour on Grease Fires**—Smother the fire with a pan lid, or use baking soda, a dry chemical or foam-type extinguisher.
- **When heating fat or grease, watch it closely.** Fat or grease may catch fire if allowed to become too hot.
- **Use Only Dry Potholders**—Moist or damp potholders on hot surfaces may result in burns from steam. Do not let potholders touch hot heating burners. Do not use a towel or other bulky cloth instead of a potholder.
- **Do Not Heat Unopened Food Containers**—Buildup of pressure may cause container to burst and result in injury.
- **Remove the oven door from any unused range if it is to be stored or discarded.**

IMPORTANT—ELECTRIC IGNITION MODELS ONLY: Do not attempt to operate the oven during a power failure. If the power fails, always turn off the oven. If the oven is not turned off and the power resumes, the oven will begin to operate again. Once the power resumes, reset the clock and oven function.

IMPORTANT INSTRUCTIONS FOR USING YOUR COOKTOP

- **WARNING Use Proper Flame Size**—Adjust flame size so it does not extend beyond the edge of the utensil. The use of undersized utensils will expose a portion of the burner flame to direct contact and may result in ignition of clothing. Proper relationship of utensil to flame will also improve efficiency.
- **Know which knob controls each surface burner.** Place a pan of food on the burner before turning it on, and turn the burner off before removing the pan.
- **Always turn knob to the full LITE position when igniting top burners.** Visually check that burner has lit. Then adjust the flame so it does not extend beyond the edge of the utensil.
- **Utensil Handles Should Be Turned Inward and Not Extend Over Adjacent Surface Burners**—To reduce the risk of burns, ignition of flammable materials, and spillage due to unintentional contact with the utensil, the handle of the utensil should be positioned so that it is turned inward, and does not extend over adjacent surface burners.
- **Never Leave Surface Burners Unattended at High Heat Settings**—Boilovers cause smoking and greasy spillovers that may ignite, or a pan that has boiled dry may melt.

- **Protective Liners**—Do not use aluminum foil to line surface burner pans, or oven bottom, except as suggested in this manual. Improper installation of these liners may result in risk of electric shock, or fire.
- **Glazed Cooking Utensils**—Only certain types of glass, glass/ceramic, ceramic, earthenware, or other glazed utensils are suitable for cooktop service without breaking due to the sudden change in temperature. Check the manufacturer's recommendations for cooktop use.

IMPORTANT INSTRUCTIONS FOR USING YOUR OVEN

- **Use Care When Opening Oven Door or Warmer Drawer/ Bake-n-Warm™ Double Oven (if equipped).** Stand to the side of the range when opening the door of a hot oven. Let hot air or steam escape before you remove or replace food in the oven.
- **Keep Oven Vent Ducts Unobstructed.** The oven vent is located below the backguard. Touching the surfaces in this area when the oven is operating may cause severe burns. Also, do not place plastic or heat-sensitive items on or near the oven vent. These items could melt or ignite.
- **Placement of Oven Racks.** Always place oven racks in desired location while oven is cool. If rack must be moved while oven is hot use extreme caution. Use potholders and grasp the rack with both hands to reposition. Do not let potholders contact the hot heating elements in the oven. Remove all utensils from the rack before moving.
- **Do not use the broiler pan without its insert.** The broiler pan and its insert allow dripping fat to drain and be kept away from the high heat of the broiler.
- **Do not cover the broiler insert with aluminum foil. Exposed fat and grease could ignite.**
- Cold temperatures can damage the electronic control. When using the appliance for the first time, or when the appliance has not been used for an extended period of time, be certain the unit has been in temperatures above 32°F (0°C) for at least 3 hours before turning on the power to the appliance.

IMPORTANT INSTRUCTIONS FOR CLEANING YOUR RANGE

- **Clean the range regularly to keep all parts free of grease that could catch fire.** Pay particular attention to the area underneath each surface element. Do not allow grease to accumulate. Refer to the range manufacturer's instructions for cleaning.
- **Kitchen cleaners and aerosols—Always follow the manufacturer's recommended directions for use.** Be aware that excess residue from cleaners and aerosols may ignite causing damage and injury.

SELF CLEANING OVENS

- **Clean in the self-cleaning cycle only the parts listed in this Owner's Guide.** Before self cleaning the oven, remove the broiler pan and any utensils or foods from the oven.
- **Do Not Use Oven Cleaners**—No commercial oven cleaner or oven liner protective coating of any kind should be used in or around any part of the oven.
- **Do Not Clean Door Gasket**—The door gasket is essential for a good seal. Care should be taken not to rub, damage or move the gasket.

Important Safety Instructions



Important Safety Notice

The California Safe Drinking Water and Toxic Enforcement Act requires the Governor of California to publish a list of substances known to the state to cause cancer, birth defects or other reproductive harm, and requires businesses to warn customers of potential exposure to such substances.

Grounding type
wall receptacle

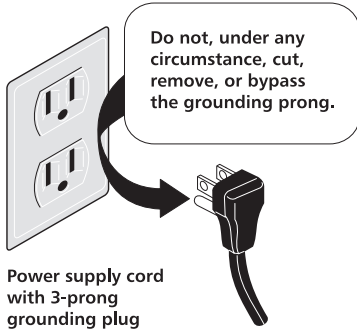

Grounding Instructions

⚠ WARNING Avoid fire hazard or electrical shock. Do not use an adapter plug, an extension cord, or remove grounding prong from electrical power cord. Failure to follow this warning can cause serious injury, fire or death.

⚠ WARNING This appliance is equipped with a 3-prong grounding plug for your protection against shock hazard and should be plugged directly into a properly grounded receptacle. **DO NOT** cut or remove the grounding prong from this plug.

For personal safety, the range must be properly grounded. For maximum safety, the power cord must be plugged into an electrical outlet that is correctly polarized and properly grounded. If a 2-prong wall receptacle is the only available outlet, it is the personal responsibility of the consumer to have it replaced with a properly grounded 3-prong wall receptacle installed by a qualified electrician.

See the **INSTALLATION INSTRUCTIONS** packaged with this range for complete installation and grounding instructions.

Conversion to Liquefied Petroleum Gas (or L.P. Gas)

PLEASE NOTE: This natural gas range is NOT designed for conversion to Liquefied Petroleum (L.P.) Gas.



Features At A Glance

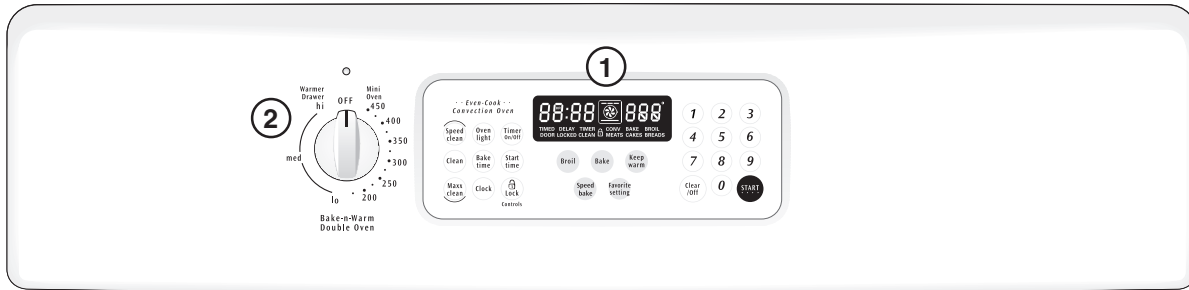

Your Gas Range Features Include:

1. Electronic Oven Control with Kitchen Timer.
2. Bake-n-Warm™ Double Oven Control & Indicator Light.
3. Left Front Burner Valve & Knob.
4. Left Rear Burner Valve & Knob.
5. Center Burner Valve & Knob (some models).
6. Right Rear Burner Valve & Knob.
7. Right Front Burner Valve & Knob.
8. Easy to clean Deep Well style cooktop.
9. Dishwasher safe Burner Grates (styles & colors vary by model).
10. Dishwasher safe Center Burner Grate (some models)
11. Self-Clean Oven Door Latch.
12. Automatic Oven Door Light Switch (some models).
13. Oven Interior Light with Shield.
14. Self-Cleaning Oven interior.
15. Adjustable Oven Rack(s).
16. Speed Bake™ Cooking System Fan & Cover.
17. Large 1 piece Oven Door Handle.
18. Full width Oven Door (styles vary with model).
19. Bake-n-Warm™ Double Oven, Drawer Rack, Drawer Handle, Interior Light (some models) & Window (some models).
20. 5,000 BTU Simmer Burner (some models).
21. 9,500 BTU Burner (some models).
22. 12,000 BTU Power Plus Burner (some models).
23. 14,000 BTU Power Plus Burner (some models).
24. 16,000 BTU Power Plus Burner (some models).
25. 9,500 BTU Center Burner (some models).
26. Broil Pan (some models).
27. Broil Pan Insert (some models).
28. Roasting Rack (some models).
29. Griddle (some models).
30. Leveling Legs & Anti-tip Bracket (included).

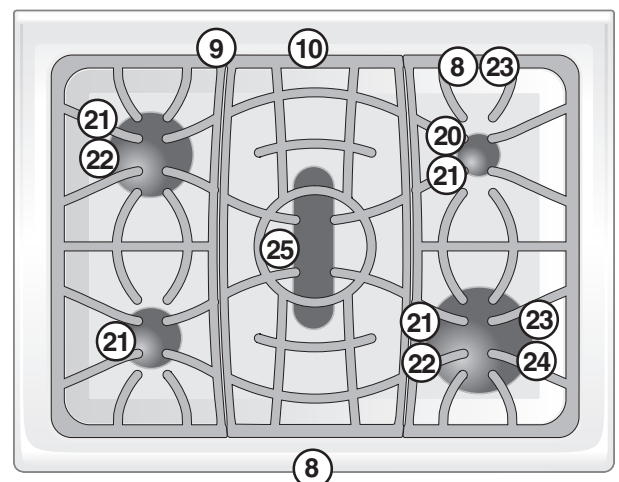
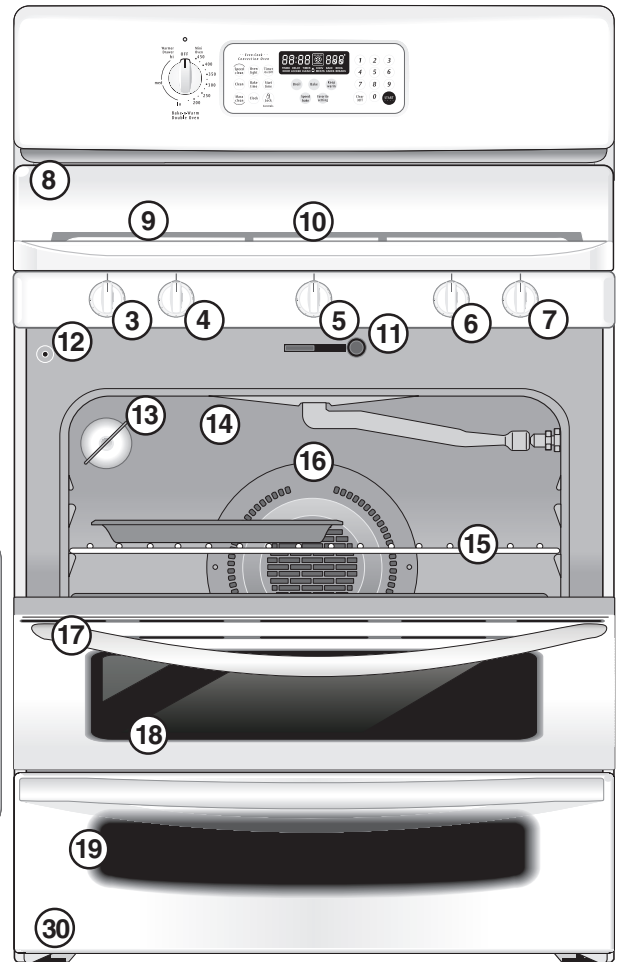
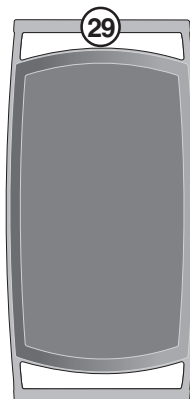
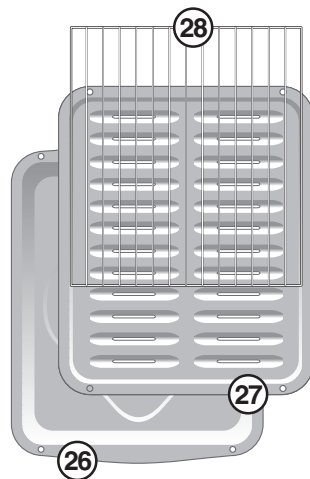

NOTE: The features of your range may vary according to model type & color.

Before Setting Oven Controls

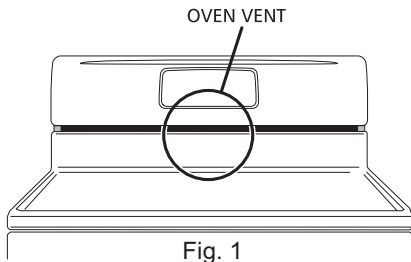

Fig. 1

Oven Vent Location

The oven vent is located **below the backguard** (See Fig. 1). When the oven is on, warm air is released through this vent. This venting is necessary for proper air circulation in the oven and good baking results. **DO NOT BLOCK THE VENT.**

Removing & Replacing Oven Racks

To remove, pull the rack forward until it stops. Lift up front of rack and slide out.
To replace, fit the rack onto the guides on the oven walls. Tilt the front of the rack upward and slide the rack back into place.

Oven Racks

Your range is equipped with one or more **Flat Oven Rack(s)**. Place the rack(s) into the positions shown in Fig. 2. Refer to the following *Recommended Rack Positions for Broiling, Baking & Roasting* for complete information.

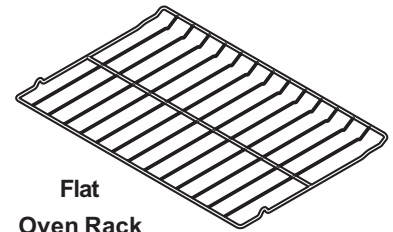

Fig. 2

Arranging Oven Racks

ALWAYS ARRANGE OVEN RACKS WHEN THE OVEN IS COOL (PRIOR TO OPERATING THE OVEN). Always use oven mitts when using the oven.

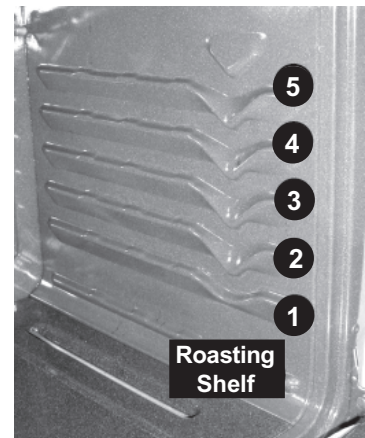

Fig. 3

Recommended Rack Positions for Broiling, Baking & Roasting:

Food	Rack Position
Broiling hamburgers & steaks	See Broil section
Broiling meats, chicken or fish	See Broil section
Cookies, cakes, pies, biscuits & muffins	2 or 3
Frozen pies, angel food cake, yeast, bread, casseroles, small cuts of meat or poultry	1 or Roasting Shelf
Turkey, roast or ham	1 or Roasting Shelf

Baking Layer Cakes with 1 or 2 Oven Racks

For best results when baking cakes using 2 oven racks, place cookware on rack positions 1 & 4 (See Figs. 3 & 4). For best results when using a single oven Flat Rack, place cookware on rack position 2 or 3 (See Figs. 3 & 5).

Air Circulation in the Oven

For best air circulation and baking results allow 2-4" (5-10 cm) around the cookware for proper air circulation and be sure pans and cookware do not touch each other, the oven door, sides or back of the oven cavity. The hot air must be able to circulate around the pans and cookware in the oven for even heat to reach around the food.



Fig. 4

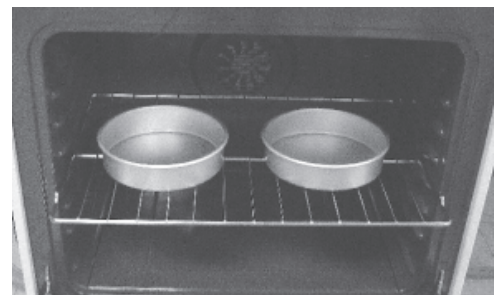

Fig. 5



Setting Surface Controls

CAUTION Do not place plastic items such as salt and pepper shakers, spoon holders or plastic wrappings on top of the range when it is in use. These items could melt or ignite. Potholders, towels or wood spoons could catch fire if placed too close to a flame.

In the event of an electrical power outage, the surface burners can be lit manually. To light a surface burner, hold a lit match to the burner head, then slowly turn the surface control knob to **LITE**. After burner lights push in and turn knob to desired setting. Use caution when lighting surface burners manually.



OFF ..LITE.. hi 6 5 4 3 2 lo

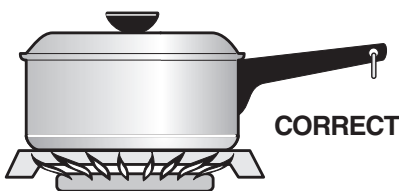

Never extend the flame beyond the outer edge of the utensil. A higher flame simply wastes heat and energy, and increases your risk of being burned by the flame.

Setting Surface Controls

Your range may be equipped with different sized surface burners. The ability to heat food quicker and in larger volumes increases as the burner size increases. The **Simmer** burner (some models) is best used for simmering delicate food items such as sauces, etc.

The standard burners can be used for most surface cooking needs. Some models include a center burner (or **griddle** burner). **Note:** Before using the center burner with the griddle, REMOVE the center burner grate from the cooktop and replace with the griddle.

The **Power Plus** burner or burners (some models) are best used for bringing large quantities of liquid to temperature and when preparing larger quantities of food.

Regardless of size, always select cookware that is suitable for the amount and type of food being prepared. Select a burner and flame size appropriate to the pan. Never allow flames to extend beyond the outer edge of the pan.

Operating the Gas Surface Burners:

1. Place cooking utensil on surface burner.
2. Push the surface control knob in and turn **counterclockwise** out of the OFF position.
3. Release the knob and rotate to the LITE position. Note: All four electronic surface igniters will spark at the same time. However, only the burner you are turning on will ignite.
3. Visually check that the burner has lit.
4. Push the control knob in and turn **counterclockwise** to the desired flame size. The control knobs do not have to be set at a particular setting. Use the guides and adjust the flame as needed. **DO NOT** cook with the surface control knob in the LITE position. (The electronic ignitor will continue to spark if the knob is left in the LITE position.)

Setting Proper Surface Burner Flame Size

For most cooking, start on the highest control setting and then turn to a lower one to complete the process. Use the recommendations below as a guide for determining proper flame size for various types of cooking. The size and type of utensil used and the amount of food being cooked will influence the setting needed for cooking.

***Flame Size**
 High Flame
 Medium Flame
 Low Flame

Type of Cooking
 Start most foods; bring water to a boil; pan broiling.
 Maintain a slow boil; thicken sauces, gravies; steaming.
 Keep foods cooking; poach; stewing.

For deep fat frying, use a thermometer and adjust the surface control knob accordingly. If the fat is too cool, the food will absorb the fat and be greasy. If the fat is too hot, the food will brown so quickly that the center will be undercooked. Do not attempt to deep fat fry too much food at once as the food will neither brown nor cook properly.

***These settings are based on using medium-weight metal or aluminum pans with lids. Settings may vary when using other types of pans.** The color of the flame is the key to proper burner adjustment. A good flame is clear, blue and hardly visible in a well-lighted room. Each cone of flame should be steady and sharp. Adjust or clean burner if flame is yellow-orange.

Control Pad Features



READ THE INSTRUCTIONS CAREFULLY BEFORE USING THE OVEN. For satisfactory use of your oven, become familiar with the various features and functions of the oven as described below. **Detailed instructions for each feature and function follow later in this Use & Care Manual.**

OVEN LIGHT—Use to turn the oven light ON and OFF.

TIMER ON/OFF—Use to set or cancel the Kitchen Timer.

BROIL—Use to select variable Broil feature.

BAKE—Use to enter the normal Bake feature.

KEEP WARM—Use to select the Keep Warm feature.

0 THRU 9 NUMBER PADS—Use to enter temperature and times.

SPEED CLEAN—Use to select a 2 hour Self-Cleaning cycle.

BAKE TIME—Use to enter the length of the baking time.

CLEAN—Use to select a 3 hour Self-Cleaning cycle.

START TIME—Use with **BAKE, BAKE TIME,** and **CLEAN PADS** to program a Delayed Timed Bake or Delay Self-Cleaning cycle.

MAXX CLEAN—Use to select a 4 hour Self-Cleaning cycle.

CLOCK—Use to set the time of day.

LOCKCONTROLS—Use to enable or disable all oven features.

Speed Bake™—Use to select the Speed-Bake feature.

FAVORITE SETTING- Use to recall stored recipes.

CLEAR/OFF—Use to cancel any oven mode previously entered except the Oven Lockout, Time of Day & Minute Timer. Press **CLEAR/OFF** to stop cooking.

START—Use to start all oven features (not used with Oven Light).

Minimum & Maximum Control Pad Settings

All of the features listed have minimum and maximum time or temperature settings that may be entered into the control. An ENTRY acceptance beep will sound each time a control pad is touched (the Oven Lockout pad is delayed by 3 seconds).

An ENTRY ERROR tone (3 short beeps) will sound if the entry of the temperature or time is below the minimum or above the maximum settings for the feature.

FEATURE		MIN. TEMP. /TIME	MAX. TEMP. /TIME
PREHEAT TEMP.		170°F / 77°C	550°F / 288°C
BAKE TEMP.		170°F / 77°C	550°F / 288°C
BROIL TEMP.		400°F / 205°C	550°F / 288°C
KITCHEN TIMER	12 Hr.	0:01 Min.	11:59 Hr. / Min.
	24 Hr.	0:01 Min.	11:59 Hr. / Min.
CLOCK TIME	12 Hr.	1:00 Hr. / Min.	12:59 Hr. / Min.
	24 Hr.	0:00 Hr. / Min.	23:59 Hr. / Min.
COOK TIME	12 Hr.	0:01 Min.	11:59 Hr. / Min.
	24 Hr.	0:01 Min.	23:59 Hr. / Min.
START TIME	12 Hr.	1:00 Hr. / Min.	12:59 Hr. / Min.
	24 Hr.	0:00 Hr. / Min.	23:59 Hr. / Min.
CLEAN TIME		2 hours	4 hours
Speed Bake™ Cooking System		300°F / 149°C	550°F / 288°C



Setting Oven Controls



Setting the Clock

The **CLOCK** (Clock) pad is used to set the clock. The clock may be set for 12 or 24 hour time of day operation. The clock has been preset at the factory for the 12 hour operation. When the range is first plugged in, or when the power supply to the range has been interrupted, the timer in the display will flash with power failure "PF" (See Fig. 1).

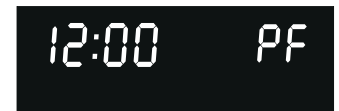

Fig. 1

INSTRUCTIONS

To set the clock (example below for 1:30):

1. Press (Clock). "CLO" will appear in the display (Fig. 2).
2. Press (1) (3) (0) pads to set the time of day to 1:30 (Fig. 3). "CLO" will appear in the display. Press (START). "CLO" will disappear and the clock will start (Fig. 4).

PRESS



DISPLAY



Fig. 2



Fig. 3

Changing between 12 or 24 hour time of day display:

1. Press and hold (Clock) for 6 seconds (Fig. 3). While holding the pad down the current time of day will remain and "CLO" will disappear from the display (Fig. 4). CONTINUE holding the pad until a beep is heard.
2. The display will show either "12Hr"(Fig. 5) or "24Hr"(Fig. 6).
3. Press (Clean) to switch between the 12 and 24 hour time of day display. The display will show either "12Hr" (Fig. 5) or "24Hr" (Fig. 6).
4. Press (START) to accept the desired change or press (Clear/Off) to reject the change.
5. Reset the correct time as described in **To set the Clock** above. Please note that if the 24 hour time of day mode was chosen, the clock will now display time from 0:00 through 23:59 hours.

(Clock) for 6 seconds

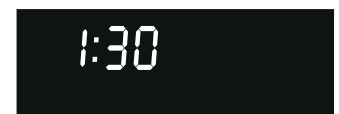

Fig. 4



Fig. 5





Fig. 6

Setting Oven Controls







Setting Continuous Bake or 12 Hour Energy Saving

The **TIMER ON/OFF**  and **CLEAN**  pads control the Continuous Bake or 12 Hour Energy Saving features. The oven control has a factory preset built-in 12 Hour Energy Saving feature that will shut off the oven if the oven control is left on for more than 11 hours and 59 minutes. The oven can be programmed to override this feature for Continuous Baking.

INSTRUCTIONS

To set the control for Continuous Bake or 12 Hour Energy Saving features:

1. Press and hold  for 6 seconds (Fig. 1). "12 Hr" or "- - Hr" will appear in the display and the control will beep once.
2. Press  to switch between the 12 Hour Energy Saving and continuous bake features. Note: "12 Hr" (Fig. 2) in the display indicates the control is set for 12 Hour Energy Saving feature and "- - Hr" (Fig. 3) indicates the control is set for the Continuous Bake feature.
3. Press  to accept the change (Fig. 4; display will return to time of day) or press  to reject the change.

PRESS

DISPLAY

 for 6 seconds



Fig. 1





Fig. 2

 or 



Fig. 3

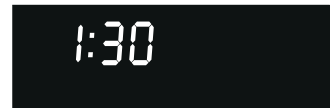







Fig. 4

Setting Kitchen Timer

The **TIMER ON/OFF**  pad controls the Kitchen Timer feature. The Kitchen Timer serves as an extra timer in the kitchen that will beep when the set time has run out. It does not start or stop cooking. The Kitchen Timer feature can be used during any of the other oven control functions. Refer to "**Minimum & Maximum Control Pad Settings**" on page 9 for time amount settings.

INSTRUCTIONS

To set the Kitchen Timer (example for 5 minutes):

1. Press . "0:00" will appear and "TIMER" will flash in the display (Fig. 5).
2. Press the number pads to set the desired time in the display (example ). Press . The time will count down with "5:00" and "TIMER" will show in the display (Fig. 6).
Note: If  is not pressed the timer will return to the time of day.
3. When the set time has run out, "End" and "TIMER" will show in the display (Fig. 7). The clock will sound with 3 beeps every 15 seconds until  is pressed.

PRESS

DISPLAY





Fig. 5



Fig. 6





Fig. 7

To cancel the Kitchen Timer before the set time has run out:

Press . The display will return to the time of day.





Setting Oven Controls

Setting Oven Lockout Feature

The  pad controls the Oven Lockout feature. The Oven Lockout feature automatically locks the oven door, prevents the Bake-n-Warm™ Double Oven and most oven controls from being turned ON. It does not disable the clock, Kitchen Timer or the interior oven light.

INSTRUCTIONS

To activate the Oven Lockout feature:

1. Press and hold  for 3 seconds (Fig. 1).
2. After 3 seconds a beep will sound, **LOC** & "**DOOR LOCKED**" will flash in the display. Once the oven door is locked the "**DOOR LOCKED**" indicator will stop flashing.

PRESS

 for 3 seconds

DISPLAY

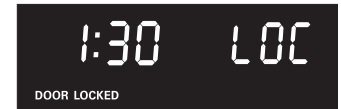



Fig. 1

To reactivate normal oven operation:

1. Press and hold  for 3 seconds. A beep will sound. **LOC** will clear. The "**DOOR LOCKED**" will continue to flash until the oven door has completely unlocked (See Fig. 2).
2. The oven is again fully operational.

 for 3 seconds

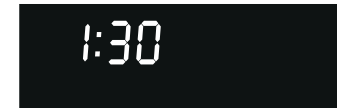







Fig. 2

Setting Temperature Display — Fahrenheit or Celsius

The **BROIL**  and **CLEAN**  pads control the Fahrenheit or Celsius temperature display modes. The oven control can be programmed to display temperatures in Fahrenheit or Celsius. The oven has been preset at the factory to display in Fahrenheit.

INSTRUCTIONS

To change display from Fahrenheit to Celsius or Celsius to Fahrenheit:

1. To tell if the display is set for Fahrenheit or Celsius press  (Fig. 3) and hold for 7 seconds; "**550°**" will first appear in the display and then a beep will sound. If "**F**" appears, the display is set to show temperatures in Fahrenheit (Fig. 4). If "**C**" appears, the display is set to show temperatures in Celsius (Fig. 5).
2. Press  to switch between Fahrenheit or Celsius display modes. The display will show either "**F**" (Fig. 4) or "**C**" (Fig. 5).
3. Press  to accept the change or press  to reject the change.

PRESS

 for 7 seconds

DISPLAY



Fig. 3

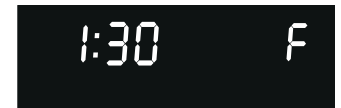

Fig. 4



Fig. 5

Setting Oven Controls



Setting Silent Control Operation

The **START TIME** (Start time) and **CLEAN** (Clean) pads control the Silent Control operation feature. The Silent Control operation feature allows the oven control to be operated without sounds or beeps whenever necessary. If desired the control can be programmed for silent operation and later returned to operating with all the normal sounds and beeps.

INSTRUCTIONS

PRESS

DISPLAY

To change control from normal sound operation to silent control operation:

1. To tell if your range is set for normal or silent operation press and hold (Start time) for 7 seconds. "0:00" will appear and "DELAY" will flash in the display (Fig. 1).

(Start time) for 7 seconds



Fig. 1

2. Press (Clean) to switch between normal sound operation and silent operation mode. The display will show either ":SP" (Fig. 2) or ":-" (Fig. 3).

(Clean)



Fig. 2

If ":SP" appears (Fig. 2), the control will operate with normal sounds and beeps. If ":-" appears (Fig.3), the control is in the silent operation mode.

3. Press (START) to accept the change or press (Clear/Off) to reject the change.

(START) or (Clear/Off)



Fig. 3



Setting Oven Controls

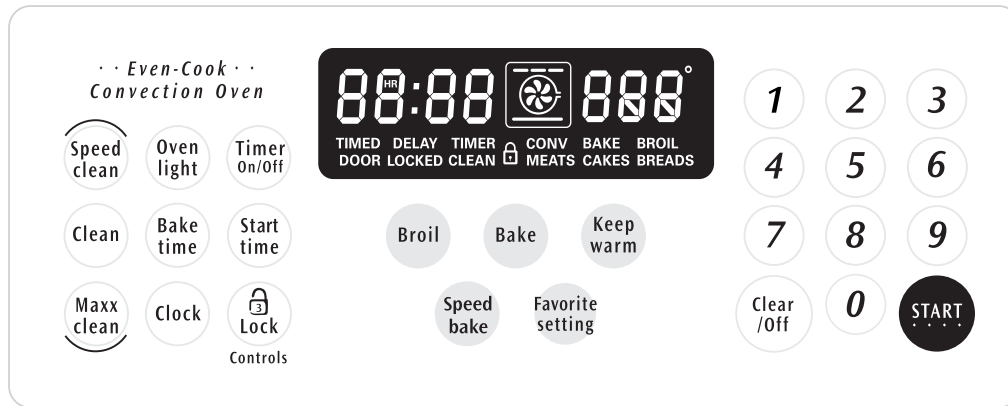





Setting Bake

The **BAKE**  pad controls normal baking. The oven can be programmed to bake at any temperature from 170°F to 550°F (The sample shown below is for 350°F).





INSTRUCTIONS

To set the Bake Temperature to 350°F:

1. Arrange interior oven racks and place food in oven.
2. Press , "- - - °" will appear in the display (Fig. 1).
3. Press    (Fig. 2). "**BAKE**" will flash and "**350°**" will appear in the display.
4. Press . A long beep will sound once the oven temperature reaches 350° F and the display will show "**350°**" and "**BAKE**" (Fig. 3).

Pressing  will cancel the Bake feature at any time.

To change the Bake Temperature (example changing from 350° to 425°F):

1. After the oven has already been set to bake at 350°F and the oven temperature needs to be changed to 425°F, press  (Fig. 4) and "- - - °" will show in the display.
2. Press    (Fig. 5). "**BAKE**" flashes and "**425°**" will appear in the display.
3. Press . "**BAKE**" and "**425°**" will appear in the display (See Fig. 6).

PRESS



DISPLAY

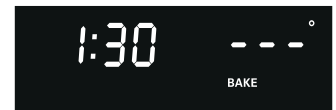

Fig. 1

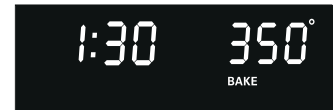

Fig. 2

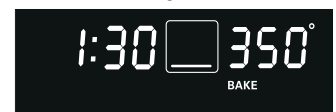

Fig. 3



Fig. 4

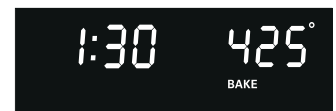

Fig. 5

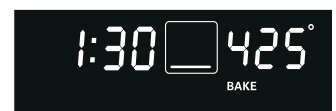



Fig. 6

Setting Oven Controls













Setting Timed Bake

The **BAKE**  and **BAKE TIME**  pads control the Timed Bake feature. The automatic timer of the Timed Bake feature will turn the oven OFF after cooking for the desired amount of time you selected.

INSTRUCTIONS

To program the oven to begin baking immediately and to shut off automatically: (example below to bake at 350°F for 50 minutes):

1. Be sure the clock is set for the correct time of day.
2. Arrange interior oven rack(s) and place the food in the oven.
3. Press , "-- -- °" will appear in the display (Fig. 1).
4. Press    (Fig. 2). "**BAKE**" will flash and "**350°**" will appear in the display.
5. Press . "**BAKE**" and "**350°**" will appear in the display (See Fig. 3).
6. Press . "**TIMED**" will flash; "**BAKE**", "**0:00**" and "**350°**" will appear in the display (Fig.4).
7. Enter the desired baking time by pressing  . "**TIMED**" will flash and "**BAKE**", "**50:00**" and "**350°**" will appear in the display (Fig. 5). Note: Baking time can be set for any amount of time between 1 minute to 11 hours and 59 minutes.
8. Press . Both "**TIMED**" and "**BAKE**" will remain on in the display (Fig. 6). Once the Timed Bake feature has started, the current time of day will appear in the display.

Note: After the Timed Bake feature has activated, press  to display the bake time remaining in the Timed Bake mode. Once Timed Bake has started baking, a long beep will sound when the oven temperature reaches the set temperature.

Press  when baking has finished or at any time to cancel the Timed Bake feature.

When the Timed Bake finishes:

1. "**End**" and the time of day will show in the display. The oven will shut off automatically (Fig. 7).
2. The control will beep 3 times. The control will continue to beep 3 times every 30 seconds until  is pressed.

PRESS

DISPLAY

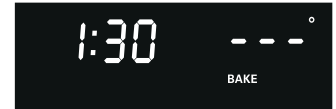

Fig. 1

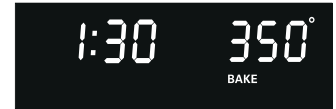

Fig. 2



Fig. 3



Fig. 4



Fig. 5



Fig. 6



Fig. 7

CAUTION Use caution with the **TIMED BAKE** or **DELAYED TIMED BAKE** features. Use the automatic timer when cooking cured or frozen meats and most fruits and vegetables. Foods that can easily spoil such as milk, eggs, fish, meat or poultry, should be chilled in the refrigerator first. Even when chilled, they should not stand in the oven for more than 1 hour before cooking begins, and should be removed promptly when cooking is completed. Eating spoiled food can result in sickness from food poisoning.

















Setting Oven Controls

Setting Delayed Timed Bake

The **BAKE** , **BAKE TIME**  and **START TIME**  pads control the Delayed Timed Bake feature. The automatic timer of the Delayed Timed Bake will turn the oven ON and OFF at the time you select in advance.

INSTRUCTIONS

To program the oven for a Delay Start (Delayed Timed Bake) and to shut off automatically (example for baking at 350°F for 50 minutes and starting at 5:30):

1. Be sure that the clock is set with the correct time of day.
2. Arrange interior oven rack(s) and place the food in the oven.
3. Press . "- - -" will appear in the display (Fig. 1).
4. Press    (Fig. 2). "BAKE" will flash and "350°" will appear in the display.
5. Press . "BAKE" and "350°" appears in the display (Fig. 3).
6. Press . "TIMED" will flash; "BAKE", "0:00" and "350°" will appear in the display (Fig.4).
7. Enter the desired baking time using the number pads by pressing  . "TIMED" will flash; "BAKE", "50:00" and "350°" will appear in the display (Fig. 5). Note: Baking time can be set for any amount of time from 1 minute to 11 hours and 59 minutes.
8. Press . "TIMED", "BAKE" and "350°" will display (Fig. 6).
9. Press . Enter the desired start time using the number pads    (Fig. 7).
10. Press . When Delay Start starts, the set oven temperature will disappear, "TIMED", "DELAY", "BAKE" and the current time of time of day will appear in the display (Fig. 8).

Note: Once Delay Start has started, press  to display the bake time remaining. Once the Delayed Timed Bake has started baking, a long beep will sound when the oven temperature reaches the set temperature.

Press  when baking has finished or at any time to cancel the Delayed Timed Bake feature.

When the set bake time runs out:

1. "End" and the time of day will show in the display. The oven will shut off automatically (Fig. 9).
2. The control will beep 3 times. The control will continue to beep 3 times every 30 seconds until  is pressed.

PRESS

DISPLAY



Fig. 1



Fig. 2



Fig. 3



Fig. 4



Fig. 5



Fig. 6



Fig. 7

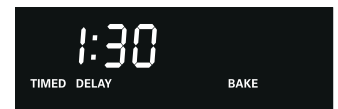

Fig. 8



Fig. 9

NOTE: If your clock is set for normal 12 hour display mode the Delayed Timed Bake feature can never be set to start more than 12 hours in advance. To set the Delayed Timed Bake feature 12-24 hours in advance see page 10 for instructions to set the control for the 24 hour time of day display mode.

Setting Oven Controls



Setting Broil

The **Broil** pad controls the **Broil** feature. When broiling, heat radiates downward from the oven broiler for even coverage. The Broil feature is preset to start broiling at 550°F however, the Broil feature temperature may be set at any temperature between 400°F and 550°F.

⚠ WARNING Should an oven fire occur, leave the oven door closed and turn the oven OFF. If the fire continues, throw baking soda on the fire or use a fire extinguisher. **DO NOT** put water or flour on the fire. Flour may be explosive and water can cause a grease fire to spread and cause personal injury.

⚠ CAUTION To insure proper results when broiling use **ONLY** Electrolux Home Products, Inc. approved Broil Pan & Insert.

The broiler pan and the insert (if equipped) allows grease to drain and be kept away from the high heat of the broiler. **DO NOT** use the pan without the insert. **DO NOT** cover the insert with foil; the exposed grease could ignite. **DO NOT** use the broil pan without the insert or cover the insert with **aluminum foil**. The exposed fat could ignite (See Fig. 5).

INSTRUCTIONS

To set the oven to broil at the default setting (550°F):

1. Place the broiler pan insert on the broiler pan. Then place the food on the broiler pan insert (See Fig. 5). **DO NOT** use the broiler pan without the insert. **DO NOT** cover the broiler insert with foil. The exposed grease could ignite.
2. Arrange the interior oven rack and place the broiler pan on the rack. Be sure to center the broiler pan directly under the broiler element. **Close the oven door. For optimum browning, preheat the broil burner for 3-4 minutes before adding food.**
3. Press **Broil**. "BROIL" will flash and "550°" will appear (Fig. 1).
4. If a lower broil temperature is desired (minimum broil temperature setting is 400°F), press the desired temperature before continuing to step 5.
5. Press **START**. The oven will begin to broil. "BROIL" and "550°" will appear in the display (Fig. 2).
6. Broil on one side until food is browned; turn and cook on the second side. Season and serve. **Note:** Always pull the rack out to the stop position before turning or removing food.
7. To cancel broiling or if finished broiling press **Clear/Off** (Fig. 3).

PRESS

DISPLAY

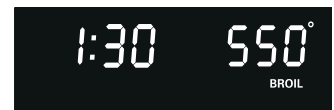

Fig. 1



Fig. 2

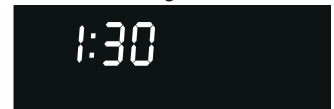

Fig. 3



Fig. 4

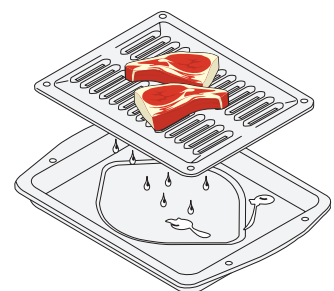

Fig. 5 (some models)

Recommended Broiling Times

Use the following table for approximate broiling times. Increase or decrease broiling times, or move the broiling pan to a different rack position to suit for doneness. If the food you are broiling is not listed in the table, follow the instructions provided in your cookbook and watch the item closely.

Broiling Table (Refer to Fig. 4)

Food Item	Rack Position	Temp Setting	Cook Time		Doneness
			1st side	2nd side	
Steak 1" thick	4th or 5th	550° F	8:00	6:00	Rare
	4th or 5th	550° F	10:00	8:00	Medium
Pork Chops 3/4" thick	4th	550° F	12:00	8:00	Well
Chicken - Bone In	3rd	450° F	25:00	15:00	Well
Chicken - Boneless	4th	450° F	10:00	8:00	Well
Fish	4th	500° F	as directed	as directed	Well
Shrimp	3rd	550° F	as directed	as directed	Well
Hamburger 3/4" thick	5th	550° F	12:00	10:00	Well
	4th	550° F	14:00	12:00	Well



Setting Oven Controls

Benefits of Speed Bake™ Cooking System:

- Some foods may cook up to 25 to 30% faster, saving time and energy.
- Multiple rack baking.
- No special pans or bakeware needed.

Setting Speed Bake™

The **Speed Bake**  pad controls the Speed Bake™ feature.

Use the Speed Bake feature when cooking speed is desired. The oven can be programmed for Speed Bake at any temperature between 300° F (149° C) to 550° F (288° C).

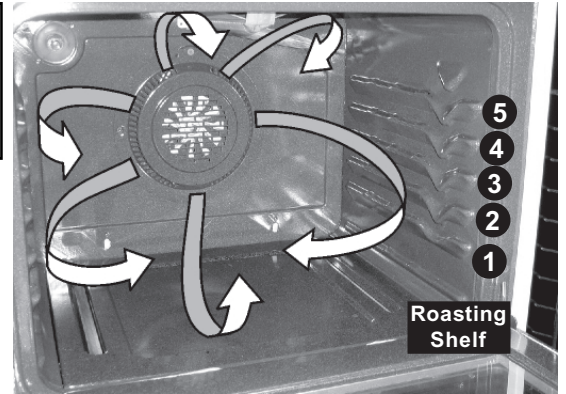

Air circulation of Convection Cooking

Fig. 1





Speed Bake™ uses a fan to circulate the oven's heat evenly and continuously within the oven (See Fig. 1). This improved heat distribution allows for even cooking and excellent results using multiple racks at the same time. Foods cooked on a single oven rack will generally cook faster and more evenly with Speed Bake. Multiple oven rack cooking may slightly increase cook times for some foods, but the overall result is time saved. Breads and pastries brown more evenly.

Tips for Speed Bake™

1. Time reductions will vary depending on the amount and type of food to be cooked. Cookies and biscuits should be baked on pans with no sides or very low sides to allow heated air to circulate around the food. Food baked on pans with a dark finish will cook faster.
2. When using Speed Bake with a single rack, place oven rack in position 2 or 3. If cooking on multiple racks, place the oven racks in positions 1 & 4 (2 oven racks). Place racks in positions 1, 3 & 5 for 3 oven racks. Refer to Fig. 1.
3. Cakes have better results when baked using the **BAKE**  pad.

INSTRUCTIONS

To set the oven for Speed Bake™ with the oven temperature at 350°F:

1. Arrange interior oven racks and place food in oven (See Fig. 1).
2. Press . "BAKE" will flash and "- - -" will appear in the display (Fig. 2).
3. Press   . "BAKE" and "350" will appear in the display (See Fig. 3).
4. Press . "BAKE" and the oven temperature **adjustment** will appear (See Fig. 4) in the display (for this example it is 325°F). A beep will sound once the **adjusted** oven temperature is reached and the fan icon will appear.

PRESS

DISPLAY



Fig. 2



Fig. 3



Fig. 4

Note: The oven icon will show a rotating fan within the square. This rotating fan icon indicates when the Speed Bake Fan is operating.

Press  to stop Speed Bake or cancel Speed Bake at any time.



Setting Oven Controls











Using the Favorite Setting Feature

The  **FAVORITE SETTING** pad is used to record and recall your favorite recipe settings. This feature may store and recall from 1 to 3 different settings. The Favorite Setting feature may be used with **Bake** or a **Timed Bake**. This feature will not work with any other function including a **Delayed Timed Bake** setting.



INSTRUCTIONS

To Program the Oven to record a recipe setting and begin baking (sample shown is for bake at 350°F):

- Place the food in the oven.
- Press . "BAKE" flashes and " — — — ° " appears in the display (See Fig. 1)
- Within 5 seconds, press . (Note:  or  may also be used to store a recipe setting). "BAKE" flashes, "- 1-" and " — — — ° " appears in the display (See Fig. 2).
- Press   . "BAKE" flashes, "- 1-" and " 350°" appears in the display (See Fig. 3).
- Press and hold  pad for at least 3 seconds or until a beep sounds. The beep indicates that the recipe setting has been recorded for future recall. The display will show 350° and "BAKE" (See Fig. 4).

NOTE: The oven will continue to bake unless  is pressed.

To Begin Baking recalled setting (example below recalling from the number 1 pad) :

- Place the food in the oven.
- Press . "BAKE" flashes and " — — — ° " appears in the display (See Fig. 5).
- Within 5 seconds, press . "BAKE" flashes, "- 1-" and " 350°" appears in the display (See Fig. 3).
- Press . The oven will begin to immediately cook with the previously recorded recipe (See Fig. 4). The Temperature is recalled and if a Timed Bake was recorded this feature will also recall the cooking time.

To turn ON/OFF the Oven Lights

The oven lights automatically turn ON when the door is opened. The oven lights may also be manually turned ON or OFF by pressing the  pad.

The interior oven light is located at the upper left rear wall of the oven interior and is covered with a glass shield held by a wire holder. The glass shield must be in place whenever the oven is in use. To change the interior oven light, see "Changing the Oven Light" in the **Care & Cleaning** section. See the **Bake-n-Warm™ Double Oven** section for instructions to change the lower oven light.

PRESS

DISPLAY

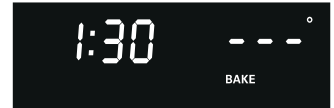

Fig. 1



Fig. 2



Fig. 3

hold  for 3 seconds



Fig. 4

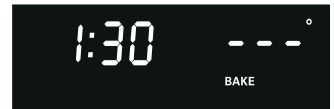

Fig. 5





Setting Oven Controls



Setting the Sabbath Feature (for use on the Jewish Sabbath & Holidays)

The **BAKE TIME** and **START TIME** pads are used to set the Sabbath feature. The Sabbath feature may only be used with the pad. The oven temperature may be set higher or lower after setting the Sabbath feature (the oven temperature adjustment feature should be used only during Jewish Holidays), however the display will not visibly show and no audible tones will be provided when a change occurs. Once the oven is properly set using Bake with the Sabbath feature active, the oven will remain continuously ON until cancelled. This will override the factory preset 12-Hour Energy Saving feature. If the oven light is needed during the Sabbath, press before activating the Sabbath feature. Once the oven light is turned ON and the Sabbath feature is active, the oven light will remain ON until the Sabbath feature is turned OFF. If the oven light needs to be OFF, be sure to turn the oven light OFF before activating the Sabbath feature.

IMPORTANT NOTES: It is not advised to attempt to activate any other program feature except **BAKE** while the Sabbath feature is active. ONLY the following key pads will function correctly with the Sabbath feature: **0-9 number pads**, , & . **ALL OTHER KEYPADS** should not be used once the Sabbath feature is activated.

INSTRUCTIONS

PRESS

DISPLAY

To Program the Oven for 350°F, Begin Baking Immediately and activate the Sabbath feature:

1. Be sure that the clock is set with the correct time of day.
2. Arrange the oven racks and place the food in the oven.
3. Press , "-- - °" will appear in the display (Fig. 1).
4. Press (Fig. 2). "**BAKE**" will flash and "**350°**" will appear in the display.
5. Press . The display will show "**350°**" and "**BAKE**". The oven will turn ON and begin heating (See Fig. 3).
6. If a **Timed Bake** or **Delayed Timed Bake** is needed then enter the time in this step. If not, skip this step and continue to step 7. Refer to the **Timed Bake** or **Delayed Timed Bake** instructions on pages 15-16. Remember the oven will shut down after completing a **Timed Bake** or **Delayed Timed Bake** and therefore may only be used once during the Sabbath/Jewish Holidays. The maximum delay time is 11 hours & 59 minutes.
7. At the same time press and hold both the and pads for at least 3 seconds. The control will beep and **SAb** will appear in the display (See Fig. 4). Once **SAb** appears in the display the oven control will no longer beep or display any further changes and the oven is properly set for the Sabbath feature.

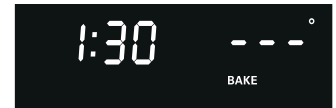

Fig. 1

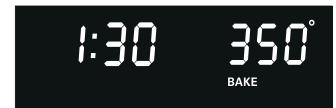

Fig. 2



Fig. 3



Fig. 4

Note: You may change the oven temperature once baking has started. Press , enter the oven temperature change (170 to 550F°) and press (for Jewish Holidays only). Remember that **the oven control will no longer beep or display any further changes** once the oven is set for the Sabbath feature.



7. The oven may be turned OFF at any time by pressing pad (this will turn the oven OFF only). To turn OFF the Sabbath feature press and hold at the same time both the and pads for at least 3 seconds. **SAb** will disappear from the display.

Setting Oven Controls



Setting the Sabbath Feature (cont'd)

It is recommended that any oven temperature change with the Sabbath feature activated be followed with 2 presses of the **START** pad. This will insure the oven remains ON even if the attempt to set the oven temperature was lower or higher than the oven control can accept. If the oven temperature is set incorrectly, the oven temperature will default to 170°F or 550°F. Try to set the desired oven temperature again.

Should you experience a power failure or interruption, the oven will shut off. When power is returned the oven will not turn back on automatically. The oven will remember that it is set for the Sabbath and the food may be safely removed from the oven while still in the Sabbath feature, however the oven cannot be turned back on until after the Sabbath/Holidays. After the Sabbath observance turn OFF the Sabbath feature. At the same time press and hold both the  and  pads for at least 3 seconds. **SAb** will disappear from the display and the oven may be used with all normal functions. For further assistance, guidelines for proper usage, and a complete list of models with the Sabbath feature, please visit the web at <http://www.star-k.org>.

Setting the Keep Warm Feature

The  pad turns ON the Keep Warm feature and will maintain an oven temperature of 170° F. The **Keep Warm** feature will keep oven baked foods warm for serving up to 3 hours after cooking has finished. After 3 hours the Keep Warm feature will shut the oven OFF automatically. The Keep Warm feature may be used without any other cooking operations or can be used after cooking has finished using **TIMED BAKE** or **DELAYED TIMED BAKE**.

INSTRUCTIONS

PRESS

DISPLAY

To set Keep Warm:





1. Arrange interior oven racks and place baked food in oven. If the food is already in the oven go to step 2.
2. Press . "HLd" will appear in the display (See Fig. 1).
Note: If no further pads are touched within 25 seconds the request to turn ON Keep Warm will be cleared.
3. Press . "HLd" shows and the oven icon will appear in the display (See Fig. 2).
4. To turn Keep Warm OFF at any time press  or .







Fig. 1



Fig. 2

To set Keep Warm to turn ON automatically:

1. Arrange interior oven racks and place food in oven. Set the oven properly and start a **Timed Bake** or **Delayed Timed Bake**.
2. Press . "HLd" will appear in the display.
3. Press . "HLd" shows and the oven icon will appear in the display. Keep Warm is set to turn ON automatically after completing a **Timed Bake** or **Delay Start** (Delayed Timed Bake).
4. To turn Keep Warm OFF at any time press  or .



Note: The Keep Warm feature can be turned ON or OFF at anytime without canceling Bake or any other cooking functions by pressing .



Bake-n-Warm™ Double Oven

Dual Features of the Bake-n-Warm™ Double Oven

The Bake-n-Warm™ Double Oven is designed to provide two unique food preparation features. The features provide a Mini Oven and a Warmer Drawer using the same lower oven cavity, drawer and control.

The Mini Oven feature is ideal for cooking foods such as pizza, casseroles, baked potatoes and frozen convenience foods. The purpose of the Warmer Drawer feature is to keep hot cooked foods at serving temperature. Always start with hot food. It is not recommended to heat cold food in the Warmer Drawer.

BE SURE TO READ THE FOLLOWING WARNINGS AND CAUTIONS before using the Bake-n-Warm™ Double Oven:

⚠ WARNING KEEP CHILDREN AWAY FROM THE LOWER OVEN WHEN HOT. FAILURE TO DO SO CAN RESULT IN BURNS.

⚠ CAUTION FOOD POISONING HAZARD. Do not let food sit for more than one hour before or after cooking. Doing so can result in food poisoning or sickness.

⚠ CAUTION Always use oven mitts when removing food from the Bake-n-Warm™ Double Oven. The drawer rack, drawer compartment, cookware and plates may be hot.

⚠ CAUTION Should an oven fire occur, close the drawer and turn the Bake-n-Warm™ Double Oven OFF. If the fire continues, use a fire extinguisher. **DO NOT** put water or flour on the fire. Flour may be explosive.

Using the Mini Oven or Warmer Drawer Features

- **When placing food in the Mini Oven always use a baking sheet or pan with 4 raised sides to prevent food from sliding off.**
- For best results, place foods such as pizzas, frozen convenience foods on a cookie sheet. Pastries, casseroles with crumb toppings and bakery type items may have better results in the larger upper oven.
- To minimize sliding of bake ware, open and close the drawer gently, making sure the drawer latches when closed.
- During cooking/warming, limit the number of times the drawer is opened. This will minimize heat loss. Repeated opening of the drawer during the cooking process may increase cooking times and produce uneven cooking results. The cooking time for the Mini Oven feature may vary slightly from the upper oven times.
- The maximum height of foods and utensils that may be used in the Bake-n-Warm™ Oven is 2-1/2". The maximum width is 15". **Pay close attention to foods that have potential to rise beyond the recommended 2-1/2" maximum height.**
- Use pans in the drawer large enough to hold food **and** any juices that may result from the cooking process.
- The Drawer Rack must always be in place when cooking or warming foods in the drawer. Be sure that the rack is placed with the down turned sides into the drawer. This will provide for some air space between the drawer and the food (See Fig. 1). Do not put food or utensils directly on the oven drawer bottom.
- **Do not use plastic wrap to cover food. Plastic may melt onto the drawer or surrounding areas and be very difficult to clean.** Use a lid or aluminum foil instead. Use only utensils and cookware in the oven drawer that are recommended for oven use in the upper oven.
- **DO NOT LINE THE OVEN DRAWER WITH FOIL OR COVER THE OVEN RACK WITH FOIL.** This may result in damage to your oven.

NOTES: The Bake-n-Warm™ Double Oven will not operate when the upper oven is set for Self-Cleaning or the Oven Control Lockout feature is active. If the Bake-n-Warm™ Double Oven is ON and a Self-Clean or Oven Control Lockout request is attempted, the oven control will deny the request with a triple beep.

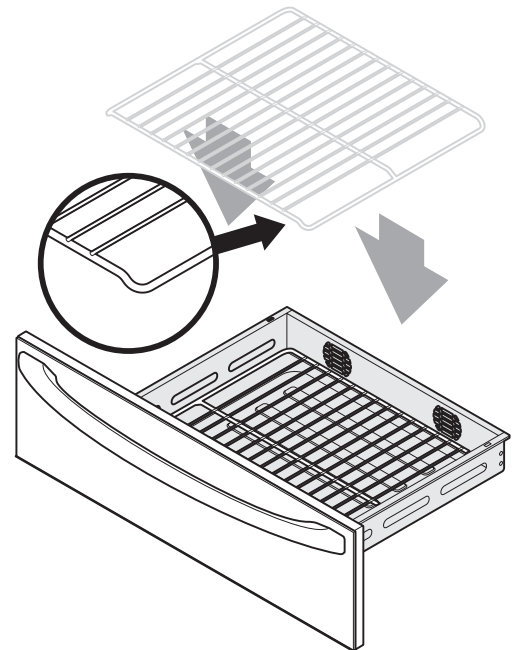
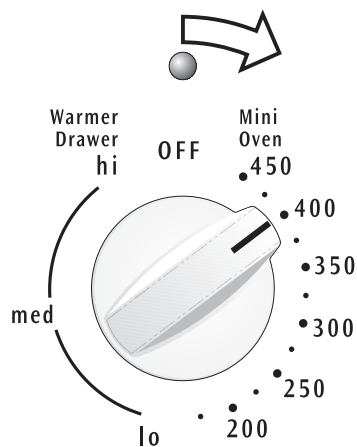

Fig. 1



Fig. 2

Bake-n-Warm™ Double Oven



Bake-n-Warm Double Oven

Fig. 1

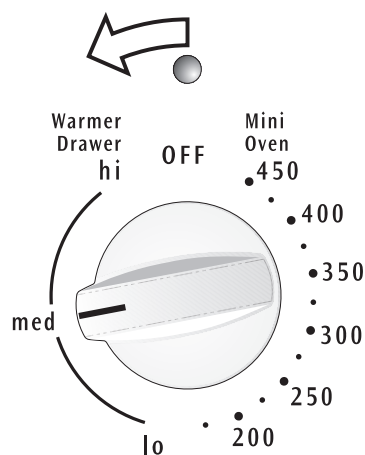

Bake-n-Warm Double Oven

Fig. 2

To Set the Mini Oven Feature of the Bake-n-Warm™ Double Oven:

1. Push in and turn the Bake-n-Warm™ control knob clockwise to the desired temperature setting (See Fig. 1). A beep will sound and the Bake-n-Warm™ Double Oven Indicator Light will glow indicating the oven is ON.
2. For best results always preheat the oven drawer before adding food. An empty oven drawer will preheat in approximately 15 minutes.
3. The indicator light above the control knob will remain ON constantly through the preheat and cooking process.
4. When the preheat beep sounds, open the Bake-n-Warm™ drawer completely. Place the food on the drawer rack using oven mitts (See Fig. 2 on previous page).
5. Gently close the drawer, making sure it latches closed.
6. When done cooking, turn the control knob to the OFF position. Remove prepared food from the drawer.

CAUTION Always use oven mitts when removing food from the Bake-n-Warm™ Double Oven. The drawer rack, drawer compartment, cookware and plates may be hot.

Warmer Drawer Recommended Food Settings Table	
Food Item	Setting
Bacon	HI
Hamburger Patties	HI
Poultry	HI
Pork Chops	HI
Fried Foods	HI
Pizza	HI
Gravies	MED
Casseroles	MED
Eggs	MED
Roasts (Beef, Pork, Lamb)	MED
Vegetables	MED
Biscuits	MED
Rolls, hard	MED
Pastries	MED
Rolls (soft)	LO
Empty Dinner Plates	LO

Fig. 3

To Set the Warmer Drawer Feature of the Bake-n-Warm™ Double Oven:

1. Push in and turn the Bake-n-Warm™ knob counterclockwise to the desired Warmer Drawer setting. A beep will sound and the Bake-n-Warm™ Double Oven Indicator Light will glow indicating the oven is ON. Note: The temperatures are approximate, and are designated by **HI** (high), **MED** (medium) and **LO** (low). Use the recommended Warmer Drawer food settings for the type of food placed in the oven drawer (See Fig. 3)
2. For best results, preheat the oven drawer before adding food. An empty oven drawer will preheat in approximately 5 minutes.
3. The indicator light above the control knob will remain ON constantly through the preheat and warming process.
4. Place the food on the oven drawer rack using oven mitts (See Fig. 2 on previous page).
5. Gently close the drawer, making sure it latches closed.
6. When the food is ready to serve, turn the control knob to the OFF position. Remove prepared food from the oven drawer.

CAUTION Always use oven mitts when removing food from the Bake-n-Warm™ Double Oven. The drawer rack, drawer compartment, cookware and plates may be hot.

Warmer Drawer Temperature Selection

Recommended Warmer Drawer food settings are shown in Fig. 3. If a particular food is not listed, start with the MED (medium) setting. If more crispness is desired, remove the lid or aluminum foil from the food. Most foods can be kept at serving temperatures on the MED setting. When a combination of foods are to be kept warm (for example a meat with 2 vegetables and rolls) use the HI (high) setting.

Recommended Cleaning Tips for the Bake-n-Warm™ Double Oven Drawer

For easier clean-up, the Bake-n-Warm™ Double Oven should be cleaned as soon as the oven cools down. Clean after each use to minimize build-up of spatter and food leftovers. When cooking foods that spatter, cover the food with heat-proof lid or foil. Use a mild detergent and water to clean the oven drawer and sides. For stubborn soils use a nonabrasive cleaning pad to remove soils. **DO NOT** use oven cleaners on Bake-n-Warm™ oven cavity.



Bake-n-Warm™ Double Oven

Bake-n-Warm™ Double Oven Light Operation (some models):

The Bake-n-Warm™ Double Oven light operates with the upper oven light and automatically turns ON when the upper oven door is opened. If equipped, the Bake-n-Warm™ Double Oven light may also be manually operated by pressing the



To Remove the Bake-n-Warm™ Double Oven Drawer & Replace the Oven Light:

1. Before drawer removal, be sure to turn OFF the Bake-n-Warm™ Double Oven and let the drawer area cool completely.
2. Pull the drawer away from the oven. Using a phillips-head screwdriver remove the two drawer screws from the insides of the front oven drawer compartment (See Fig. 1).
3. With one hand hold the drawer front in place. Use your other hand to pull the glide away from the oven (See Fig. 2) until the glide hook disengages (See Fig. 3).
4. Repeat from step 3 above for the other side of the drawer.
5. With BOTH glide hooks disengaged, carefully lift the drawer up and away from the oven. Push both drawer glides into lower oven cavity.
6. Replace the lower oven light with a 40 Watt Appliance light bulb (Refer to Fig.5).

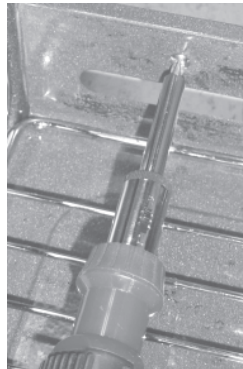

Fig. 1

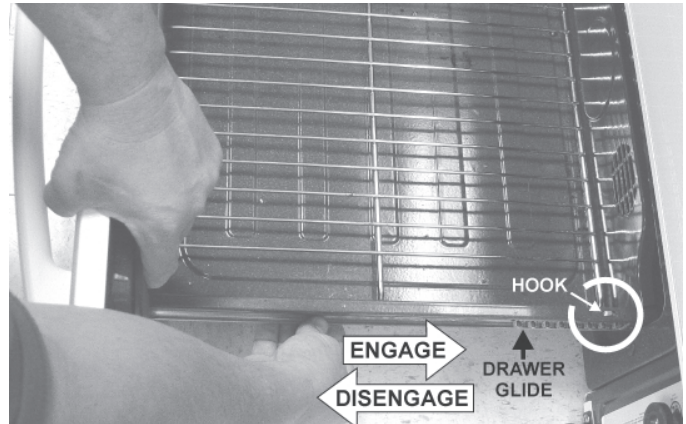
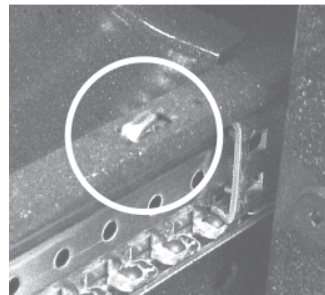
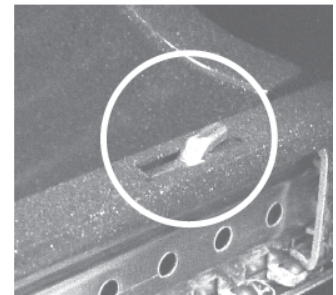

Fig. 2



Glide Hook Disengaged
Fig. 3



Glide Hook Engaged
Fig. 4

CAUTION Be sure the range is unplugged and all parts are COOL before replacing oven light. Wear a leather-faced glove for protection against possible broken glass. Use CAUTION when reaching across the oven element and brackets. These parts may be sharp and cause cuts.



Fig. 5

To replace Bake-n-Warm™ Double Oven Drawer:

1. Pull both drawer glides and fully extend outward from lower oven cavity.
2. Carefully rest the drawer on top of both glides.
3. Adjust the drawer position on top of the rails until both of the drawer side slots are correctly engaged with the glide hooks (See Fig. 4).
4. Pull the drawer forward to line up the drawer with both screw holes in the glides. Using a phillips-head screwdriver replace the two screws removed from the inner drawer sides.
5. Replace drawer rack if removed.
6. Close lower oven drawer.

Self-Cleaning Oven

A Self-Cleaning oven cleans itself with high temperatures (well above cooking temperatures) which eliminate soils completely or reduces them to a fine powdered ash you can wipe away with a damp cloth.

CAUTION During the Self-Cleaning cycle, the outside of the range can become very hot to the touch. **DO NOT** leave small children unattended near the appliance.

CAUTION The health of some birds is extremely sensitive to the fumes given off during the Self-Cleaning cycle of any range. Move birds to another well-ventilated room.

CAUTION **DO NOT** line the oven walls, racks, bottom or any other part of the range with **aluminum foil**. Doing so will destroy heat distribution, produce poor baking results and cause permanent damage to the oven interior (aluminum foil will melt to the interior surface of the oven).

CAUTION **DO NOT** force the oven door open. This can damage the automatic door locking system. Use caution when opening the door after the Self-Cleaning cycle is completed. The oven may still be VERY HOT.

Adhere to the following cleaning precautions:

- **DO NOT** use oven cleaners or oven protective coatings in or around any part of the Self-Cleaning oven.
- **DO NOT** clean the oven door gasket. The woven material of the oven door gasket is essential for a good seal. Care should be taken not to rub, damage or remove the gasket.
- **DO NOT** use any cleaning materials on the oven door gasket. Doing so could cause damage.
- **Remove the broiler pan and insert, all utensils and any aluminum foil. These items cannot withstand high cleaning temperatures.**
- Remove oven racks. See "Removing & Replacing Oven Racks" under Before Setting Oven Controls. If they are not removed during the Self-Clean cycle their color will turn slightly blue & the finish will be dull. After the cycle is complete & the oven has cooled, rub the sides of the oven racks with wax paper or a cloth containing a small amount of salad oil (this will make the racks glide easier into the rack positions).
- **Remove any excessive spillovers** in the oven cavity **before** starting the Self-Cleaning cycle. To clean, use hot, soapy water and a cloth. Large spillovers can cause heavy smoke or fire when subjected to high temperatures. **DO NOT** allow food spills with a high sugar or acid content (such as milk, tomatoes, sauerkraut, fruit juices or pie filling) to remain on the surface as they may leave a dull spot even after cleaning.
- Clean any soil from the oven frame, the door liner outside the oven door gasket and the small area at the front center of the oven bottom. These areas heat sufficiently to burn soil on. Clean with soap and water.





NOTES: Prior to setting the Self-Clean cycle, any spills remaining on the oven bottom should be removed. See additional cleaning information for the oven door in the **Care & Cleaning** section.

IMPORTANT NOTES when using the Self-Clean feature:

1. The Self-Clean feature will not operate whenever a radiant surface remains ON.
2. A Self-Clean cycle cannot be started if **Oven Lockout** feature is active.
3. If a Self-Cleaning-Cycle has started but not finished and a power failure occurs, the appliance may not have thoroughly cleaned. Once power is restored, set for another Self-Clean cycle to finish.
4. If your clock is set for normal 12 hour display mode the Delay Self-Clean cycle can never be set to start more than 12 hours in advance. To set for Delay Flex-Clean 12-24 hours in advance see page 10 for instructions to set the control for the 24 hour time of day display mode.



Self-Cleaning

The **SPEED CLEAN** , **CLEAN**  & **MAXX CLEAN**  pads are used to start a Self-Cleaning cycle. When used with **START TIME**  pad, a delayed Self-Cleaning cycle may also be programmed. This feature allows for any Self-Cleaning cycle times from 2 hours (using Speed Clean), 3 hours (using Clean) to 4 hours (using Maxx Clean).

WARNING During the Self-Cleaning cycle, the outside of the range can become very hot to the touch. **DO NOT** leave small children unattended near the appliance.





CAUTION **DO NOT** force the oven door open. This can damage the automatic door locking system. Use care when opening the oven door after the Self-Cleaning cycle. Stand to the side of the oven when opening the door to allow hot air or steam to escape. The oven may still be **VERY HOT**.

INSTRUCTIONS

PRESS

DISPLAY

To start an immediate Self-Cleaning cycle or to set a delay start time of 9:00 o'clock and shut off automatically (example provided is a default 3 hour Self-Clean cycle):

1. Be sure the clock is set with the correct time of day, the oven is empty and the oven door is closed.
2. Press . "**CLEAN**" will flash, "**3:00**" (hours) and the Cooktop locked icon will show in the display (See Fig. 1). Note: 2 hours of Self-Cleaning time may be chosen by pressing  or 4 hours by pressing the  at this time.
3. Press . The "**DOOR LOCKED**" icon will flash; "**CLEAN**", Cooktop Lockout icon and the letters "**CLn**" will remain on in the display (Fig. 2).
4. As soon as the control is set, the motor driven oven door lock will begin to close automatically. Once the door has been locked the "**DOOR LOCKED**" indicator light will quit flashing and remain on. The Cooktop locked icon will remain on (Fig. 3).



 or ,  optional.



Fig. 1



Fig. 2

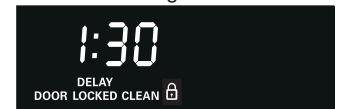







Fig. 3

NOTE: If the optional delay Self-Clean feature is needed, finish steps 5-7. If Self-Clean is started immediately skip the remaining steps and continue with "When the Self-Clean cycle is done" on the following page.

5. Press  (See Fig. 4). Enter the desired Self-Clean starting time using the number pads    (See Fig. 5).
6. Press . "**CLn**" icon will turn off; "**DELAY**", "**DOOR LOCKED**", "**CLEAN**" and Cooktop locked icons will remain on.
7. The control will calculate forward from the set start time to determine when the Self-Cleaning cycle should end. The Self-Cleaning cycle will turn on automatically at the set time. At that time the icon "**DELAY**" will go out; the oven icon will come on, the start time, Cooktop locked icon, "**CLEAN**" and "**CLn**" will remain in the display (See Fig. 6).







  



Fig. 4



Fig. 5



Fig. 6

Self-Cleaning



INSTRUCTIONS

PRESS

DISPLAY

When the Self-Clean cycle is done:

1. The time of day, "DOOR LOCKED" and "CLEAN" icon will remain in the display.
2. Once the oven has cooled down for approximately 1 HOUR, and the "DOOR LOCKED" icon is no longer displayed, the oven door can then be opened.

Stopping or Interrupting a Self-Cleaning cycle:

If it becomes necessary to stop or interrupt a Self-Cleaning cycle due to excessive smoke or fire in the oven:

1. Press .
2. Once the oven has cooled down for approximately 1 HOUR and the "DOOR LOCKED" icon is no longer displayed, the oven door can then be opened (Fig. 7).



Fig.7

Adjusting Your Oven Temperature



The temperature in the oven has been pre-set at the factory. When first using the oven, be sure to follow recipe times and temperatures. If you think the oven is too hot or too cool, the temperature in the oven can be adjusted. Before adjusting, test a recipe by using a temperature setting that is higher or lower than the recommended temperature. The baking results should help you to decide how much of an adjustment is needed.

INSTRUCTIONS

PRESS

DISPLAY

To adjust the oven temperature higher:

1. Press for 6 seconds (Fig. 1).
2. To increase the temperature use the number pads to enter the desired change. (Example 30°F) (Fig. 2). The temperature may be increased as much as 35°F (19°C).
3. Press to accept the temperature change and the display will return to the time of day (Fig. 3). Press to reject the change if necessary.



Fig. 1



Fig. 2

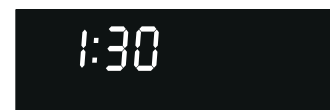

Fig. 3

To adjust the oven temperature lower:

1. Press for 6 seconds (Fig. 4).
2. To decrease the temperature use the number pads to enter the desired change. (Example -30°F) and then press (Fig. 5). The temperature may be decreased as much as 35°F (19°C).
3. Press to accept the temperature change and the display will return to the time of day (Fig. 6). Press to reject the change if necessary.



Fig. 4



Fig. 5



Fig. 6

Note: The oven temperature adjustments made with this feature will not change the Self-Clean cycle temperature.



Care & Cleaning

(Cleaning Table)

Surfaces	How to Clean
Glass, Painted Plastic Body Parts & Control Knobs	<p>For general cleaning, use a soft cloth, clean with mild dish detergent & water or a 50/50 solution of vinegar & water. Follow by rinsing the area with clean water; dry & polish with a soft cloth. Glass cleaners may be used if sprayed on a soft cloth 1st. DO NOT spray liquids directly on the control pad and display areas. DO NOT use large amounts of water on the control panel - excess water on the control area may cause damage to the appliance. DO NOT use other liquid cleaners, abrasive cleaners, scouring pads, or some paper towels - they will damage the finish.</p>
Painted Control Panels & Display areas	<p>Before cleaning the control panel, turn all controls to OFF & remove the control knobs. To remove, pull each knob straight off the shaft. Use the <i>general cleaning</i> instructions provided in the paragraph above.</p>
Porcelain Enamel Burner Grates, Cooktop Surface, Broiler Pan & Insert, Door Liner, Oven Bottom & Bake-n-Warm™ Double Oven	<p>Clean burner grates, broiler pan & insert in the dishwasher and dry upon removal. If soils are not removed, follow the cooktop cleaning instructions below.</p> <p>Gentle scouring with a soapy scouring pad will remove most spots. Rinse with a 1:1 solution of clean water & ammonia. <i>If necessary</i>, cover difficult spots with an ammonia-soaked paper towel for 30 to 40 minutes. Rinse with clean water and a damp cloth, then scrub with a soap-filled scouring pad. Rinse & wipe dry with a clean cloth. Remove all cleaners or the porcelain may become damaged during future heating. DO NOT use spray oven cleaners on the range top.</p>
Oven Racks	<p>Remove racks. See "Removing & Replacing Oven Racks" under Before Setting Oven Controls. Use a mild, abrasive cleaner, following the cleaner's recommendations. Rinse with clean water & let dry. After cleaning the racks, rub the sides of the racks with wax paper or a cloth containing a small amount of salad oil (this will make the racks glide easier into the oven rack positions).</p>
Oven Door	<p>Use soap & water to thoroughly clean the top, sides & front of the oven door. Rinse well. You may use a glass cleaner on the outside glass of the oven door. DO NOT immerse the door in water. DO NOT spray or allow water or the glass cleaner to enter the door vents. DO NOT use oven cleaners, cleaning powders or any harsh abrasive cleaning materials on the outside of the oven door. DO NOT clean the oven door gasket. The oven door gasket is made of a woven material, on Self-Cleaning models, which is essential for a good seal. Care should be taken not to rub, damage or remove this gasket.</p>
Easy Care™ Stainless Steel (some models)	<p>Your range finish is may be made with Easy Care™ Stainless Steel (some models). Clean the stainless with warm soapy water using a clean sponge or cloth. Rinse with clean water and dry with a soft clean cloth. DO NOT use ANY store bought cleaners like Stainless Steel cleaners or any other types of cleaners containing any abrasive, chlorides, chlorines or ammonia. It is recommended to use mild dish soap and water or a 50/50 solution of water and vinegar.</p>
Gas Cooktop and Surface Burners	<p>The cooktop is designed to make cleaning easier. Because the burners are sealed, cleanups are easy when spillovers are cleaned up immediately. To clean, wipe with a clean, damp cloth and wipe dry. For more information about cleaning the gas burners see Cleaning the Contoured Cooktop Well Areas, Burner Cap, Burner Head and Burner Drip Pans in the Care & Cleaning section.</p>

Care & Cleaning



Cleaning the Contoured Cooktop Well Areas, Burner Cap, Burner Head and Burner Drip Pans (some models)

The contoured well areas, burner cap, burner head and burner drip pans (some models) should be routinely cleaned. Keeping the burner ports clean will prevent improper ignition and an uneven flame. Refer to the following instructions:

THE COOKTOP IS NOT REMOVABLE. Do not attempt to remove or lift the cooktop.

CAUTION Use caution when replacing the burner cap so the electrode is not damaged. This may cause a delayed ignition or prevent the burner from igniting.

To Clean the Recessed & Contoured Areas of the Cooktop - If a spill occurs on or in the recessed or contoured areas, blot up spill with an absorbent cloth. Rinse with a clean, damp cloth and wipe dry.

To Remove & Replace the Surface Burner Caps & Surface Burner Heads - Remove in the following order: (1st) surface burner grate, (2nd) surface burner cap, (3rd) surface burner head and (4th) surface burner drip pan (if equipped).

Reverse the procedure above to replace the surface burner cap, surface burner head and surface burner drip pans (if equipped). **Do not remove any parts from the cooktop until they have completely cooled and are safe to handle. Do not operate the surface burners without the surface burner cap and surface burner head properly in place.**

To Clean the Surface Burner Cap, Surface Burner Head & Surface Burner Drip Pan (if equipped) - Use a soap-filled scouring pad or a mild abrasive cleanser to clean the surface burner caps, surface burner heads and surface burner drip pans (if equipped). The ports (or slots) around the burner head must be routinely cleaned. If residue still remains in these ports, use a small-gauge wire or needle to clean the slots or holes. For proper flow of gas and ignition of the burner—**DO NOT ALLOW SPILLS, FOOD, CLEANING AGENTS OR ANY OTHER MATERIAL TO ENTER THE GAS ORIFICE HOLDER OPENING.** **ALWAYS** keep the surface burner cap and surface burner head in place whenever a surface burner is in use.

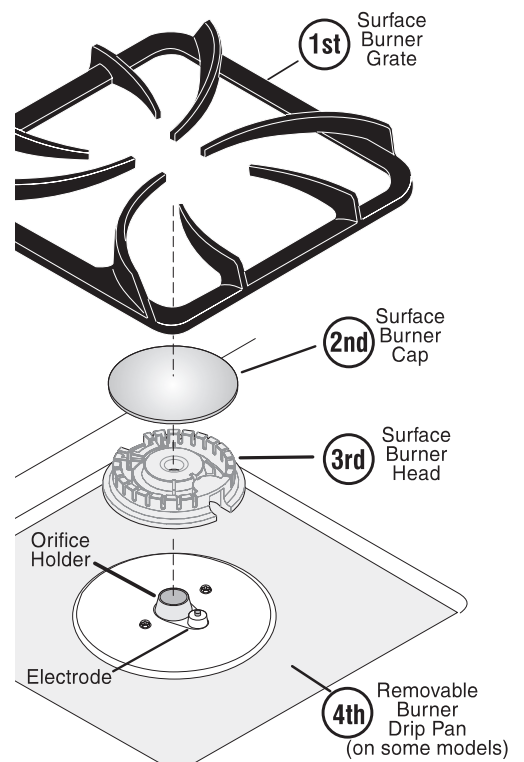



Care & Cleaning

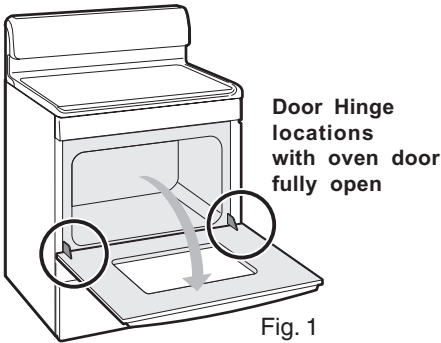

Fig. 1

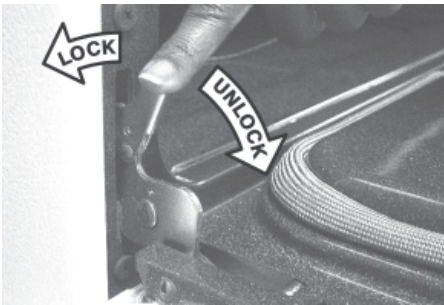

Fig. 2

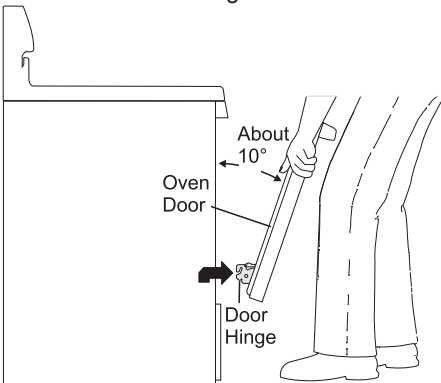

Fig. 3

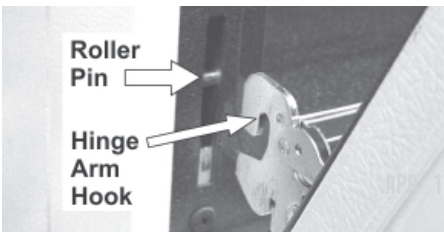

Fig. 4

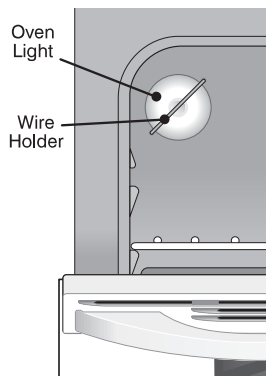

Fig. 5

Removing and Replacing the Lift-Off Oven Door

CAUTION The door is heavy. For safe, temporary storage, lay the door flat with the inside of the door facing down.

To Remove Oven Door:

1. Open oven door completely (horizontal with floor - See Fig. 1).
2. Pull the door hinge locks on both left and right door hinges down from the oven frame completely towards the oven door (See Fig. 2). A tool such as a small flat-blade screwdriver may be required.
3. Firmly grasp both sides of oven door along the door sides (Do not use the oven door handle - See Fig. 3).
4. Close the door to the broil stop position (the oven door will stop into this position just before fully closing).
5. With the oven door in the broil stop position, lift the oven door hinge arms over the roller pins located on each side of the oven frame (See Fig. 4).

To Replace Oven Door:

1. Firmly grasp both sides of oven door along the door sides (Do not use the oven door handle - See Fig. 3).
2. Holding the oven door at the same angle as the removal position, seat the hook of the hinge arm over the roller pins located on each side of the oven door frame (See Fig. 4). The hook of the hinge arms must be fully seated onto the roller pins.
3. Fully open the oven door (horizontal with floor - See Fig. 1).
4. Push the door hinge locks up towards and into the oven frame on both left and right oven door hinges (See Fig. 2) to the locked position.
5. Close the oven door.

Special Door Care Instructions

Most oven doors contain glass that can break. Read the following recommendations:

1. Do not close the oven door until all the oven racks are fully in place.
2. Do not hit the glass with pots, pans, or any other object.
3. Scratching, hitting, jarring or stressing the glass may weaken its structure causing an increased risk of breakage at a later time.

Changing the Oven Light

The oven light automatically turns ON when the door is opened. The oven light may also be manually operated by pressing the  pad. The oven light bulb is located at the rear of the oven and is covered with a glass shield held by a wire holder (See Fig. 5). The glass shield must be in place whenever the oven is in use.

To replace the oven light bulb:

1. Turn electrical power off at the main source or unplug the range.
2. Press wire holder to one side to release the glass shield.
3. Replace bulb with a new 40 watt appliance bulb.
4. Replace glass shield over bulb and snap wire holder into place.
5. Turn power back on again at the main source (or plug the range back in).
6. The clock will then need to be reset. To reset, see **Setting the Clock and Minute Timer** in this Use & Care Manual.

CAUTION Be sure the range is unplugged and all parts are COOL before replacing oven light. Wear a leather-faced glove for protection against possible broken glass.

Before You Call

Solutions to Common Problems



Before you call for service, review the following list. It may save you time & expense. The list includes common occurrences (shown in bold) that are not the result of defective workmanship or materials in this appliance. The possible corrections to these problems are provided with the problem listed:

Range is not level - (1) Poor installation. Place oven rack in center of oven. Place a level on the oven rack. Adjust leveling legs at base of range until the oven rack is level. (2) Be sure floor is level, strong & stable enough to adequately support range. (3) If floor is sagging or sloping, contact a carpenter to correct the situation. (4) Kitchen cabinet alignment may make range appear not level. Be sure cabinets are square & have sufficient room for range clearance.

Cannot move appliance easily. Appliance must be accessible for service - (1) Cabinets not square or are built in too tightly. Contact builder or installer to make appliance accessible. (2) Carpet interferes with range. Provide sufficient space so range can be lifted over carpet.

Surface burners do not light - (1) Surface control knob has not been completely turned to LITE. Push in & turn the surface control knob to LITE until burner ignites & then turn control knob to desired flame size. (2) Burner ports are clogged. With the burner OFF, use a small-gauge wire or needle to clean ports. See **Cleaning the Contoured Well Areas, Burner Cap, Burner Head & Burner Drip Pans** in the Care & Cleaning section for complete cleaning instructions. (3) Range power cord is disconnected from outlet (electric ignition models only). Be sure cord is securely plugged into the outlet. (4) Electrical power outage (electric ignition models only). Burners can be lit manually. See Setting Surface Controls.

Surface burner flame burns half way around - (1) Burner ports are clogged. With the burner off, clean ports by using a small-gauge wire or needle. (2) Moisture is present after cleaning. Lightly fan the flame and allow burner to operate until flame is full. Dry the burners thoroughly following instructions in the **Cleaning the Contoured Well Areas, Burner Cap, Burner Head & Burner Drip Pans** in the Care & Cleaning section.

Surface burner flame is orange - (1) Dust particles in main line. Allow the burner to operate a few minutes until flame turns blue. (2) In coastal areas, a slightly orange flame is unavoidable due to salt air.

Oven does not operate - (1) Be sure the oven controls are set properly for the desired function. See **Setting Oven Controls** in this Use & Care Manual or read the instructions "**Entire appliance does not operate**" in this checklist. (2) Be sure gas regulator valve is "ON". See installation instructions.

Entire appliance does not operate - (1) The time of day is not set. The time of day **must** first be set in order to operate the oven. See "To Set the Clock" in the **Setting Oven Controls** section. (2) Make sure cord/plug is plugged correctly into outlet. (3) Service wiring is not complete. Contact your authorized service agent. (4) Electrical power outage. Check house lights to be sure. Call your local electric company for service. (5) Be sure gas supply is turned ON.

Oven light does not work (some models) - Replace or tighten bulb. See **Changing Oven Light** section in this Use & Care Manual.

Oven control beeps & displays any F code error (for example F11) - Electronic control has detected a fault condition. Press **CLEAR/OFF** to clear the display & stop beeping. Reprogram oven. If fault recurs, record fault number. Press **CLEAR/OFF** & contact an authorized service agent.

Poor baking results - Many factors affect baking results. Make sure the proper oven rack position is used. Center food in the oven & space pans to allow air to circulate. Allow the oven to preheat to the set temperature before placing food in the oven. Try adjusting the recipe's recommended temperature or baking time. If you feel the oven is too hot or cool, see **Adjusting Your Oven Temperature** in this Use & Care Manual.

Oven smokes excessively during broiling - (1) Control(s) not set properly. Follow Broil instructions under **Setting Oven Controls**. (2) Oven door is open. Make sure oven door is **closed**. (3) Meat too close to the broil element. Reposition the broil rack to provide proper clearance between the meat & the element. Preheat the broil element for searing. (4) Meat not properly prepared. Remove excess fat from meat. Cut fatty edges to prevent curling, but do not cut into lean. (5) Insert on broiler pan wrong side up & grease not draining. Always place grid on the broiler pan with ribs up & slots down to allow grease to drip into pan (some models). (6) Grease has built up on oven surfaces or broiler pan & insert (some models). Regular cleaning is necessary when broiling frequently. Old grease or food spatters cause excessive smoking.

Self-Cleaning cycle does not work - (1) Oven control not set properly. Follow instructions under **Self-Cleaning**. (2) Self-Cleaning cycle was interrupted. Follow steps under "Stopping or Interrupting a Self-Cleaning Cycle" under **Self-Cleaning**.

Soil not completely removed after Self-Cleaning cycle - Failure to clean bottom, front top of oven, frame of oven or door area outside oven seal. These areas are not in the Self-Cleaning area, but get hot enough to burn on residue. Clean these areas before the Self-Cleaning cycle is started. Burned-on residue can be cleaned with a stiff nylon brush and water or a nylon scrubber. Be careful not to damage the oven gasket.

Flames inside oven or smoking from oven vent - Excessive spillovers in oven. For example this will happen for pie spillovers or large amounts of grease left on the oven bottom. Wipe up excessive spillovers before starting oven. If flames or excessive smoke are present see "Broiling" in the **Setting Oven Controls** section.



Major Appliance Warranty Information

Your appliance is covered by a one year limited warranty. For one year from your original date of purchase, Electrolux will pay all costs for repairing or replacing any parts of this appliance that prove to be defective in materials or workmanship when such appliance is installed, used and maintained in accordance with the provided instructions.

Exclusions **This warranty does not cover the following:**

1. Products with original serial numbers that have been removed, altered or cannot be readily determined.
2. Product that has been transferred from its original owner to another party or removed outside the USA or Canada.
3. Rust on the interior or exterior of the unit.
4. Products purchased "as-is" are not covered by this warranty.
5. Food loss due to any refrigerator or freezer failures.
6. Products used in a commercial setting.
7. Service calls which do not involve malfunction or defects in materials or workmanship, or for appliances not in ordinary household use or used other than in accordance with the provided instructions.
8. Service calls to correct the installation of your appliance or to instruct you how to use your appliance.
9. Expenses for making the appliance accessible for servicing, such as removal of trim, cupboards, shelves, etc., which are not a part of the appliance when it is shipped from the factory.
10. Service calls to repair or replace appliance light bulbs, air filters, water filters, other consumables, or knobs, handles, or other cosmetic parts.
11. Surcharges including, but not limited to, any after hour, weekend, or holiday service calls, tolls, ferry trip charges, or mileage expense for service calls to remote areas, including the state of Alaska.
12. Damages to the finish of appliance or home incurred during installation, including but not limited to floors, cabinets, walls, etc.
13. Damages caused by: services performed by unauthorized service companies; use of parts other than genuine Electrolux parts or parts obtained from persons other than authorized service companies; or external causes such as abuse, misuse, inadequate power supply, accidents, fires, or acts of God.

DISCLAIMER OF IMPLIED WARRANTIES; LIMITATION OF REMEDIES

CUSTOMER'S SOLE AND EXCLUSIVE REMEDY UNDER THIS LIMITED WARRANTY SHALL BE PRODUCT REPAIR OR REPLACEMENT AS PROVIDED HEREIN. CLAIMS BASED ON IMPLIED WARRANTIES, INCLUDING WARRANTIES OF MERCHANTABILITY OR FITNESS FOR A PARTICULAR PURPOSE, ARE LIMITED TO ONE YEAR OR THE SHORTEST PERIOD ALLOWED BY LAW, BUT NOT LESS THAN ONE YEAR. ELECTROLUX SHALL NOT BE LIABLE FOR CONSEQUENTIAL OR INCIDENTAL DAMAGES SUCH AS PROPERTY DAMAGE AND INCIDENTAL EXPENSES RESULTING FROM ANY BREACH OF THIS WRITTEN LIMITED WARRANTY OR ANY IMPLIED WARRANTY. SOME STATES AND PROVINCES DO NOT ALLOW THE EXCLUSION OR LIMITATION OF INCIDENTAL OR CONSEQUENTIAL DAMAGES, OR LIMITATIONS ON THE DURATION OF IMPLIED WARRANTIES, SO THESE LIMITATIONS OR EXCLUSIONS MAY NOT APPLY TO YOU. THIS WRITTEN WARRANTY GIVES YOU SPECIFIC LEGAL RIGHTS. YOU MAY ALSO HAVE OTHER RIGHTS THAT VARY FROM STATE TO STATE.

If You Need Service

Keep your receipt, delivery slip, or some other appropriate payment record to establish the warranty period should service be required. If service is performed, it is in your best interest to obtain and keep all receipts. Service under this warranty must be obtained by contacting Electrolux at the addresses or phone numbers below.

This warranty only applies in the USA and Canada. In the USA, your appliance is warranted by Electrolux Major Appliances North America, a division of Electrolux Home Products, Inc. In Canada, your appliance is warranted by Electrolux Canada Corp. Electrolux authorizes no person to change or add to any obligations under this warranty. Obligations for service and parts under this warranty must be performed by Electrolux or an authorized service company. Product features or specifications as described or illustrated are subject to change without notice.

USA
1.800.944.9044
Electrolux Major Appliances
North America
P.O. Box 212378
Augusta, GA 30907



Canada
1.800.668.4606
Electrolux Canada Corp.
5855 Terry Fox Way
Mississauga, Ontario, Canada
L5V 3E4

Free Manuals Download Website

<http://myh66.com>

<http://usermanuals.us>

<http://www.somanuals.com>

<http://www.4manuals.cc>

<http://www.manual-lib.com>

<http://www.404manual.com>

<http://www.luxmanual.com>

<http://aubethermostatmanual.com>

Golf course search by state

<http://golfingnear.com>

Email search by domain

<http://emailbydomain.com>

Auto manuals search

<http://auto.somanuals.com>

TV manuals search

<http://tv.somanuals.com>