

Measure what you see.

LCS IV and LCM IV



User Manual

7/2012 Edition 1A



Table of Contents

Section 1 Specifications	7
Section 2 General Information	9
2.1 Safety information	9
2.1.1 Precautionary labels	9
2.1.2 Safety around source lamps	10
2.1.3 Chemical and biological safety	10
2.2 Overview of product	10
Section 3 Installation	13
3.1 Unpacking the instrument	13
3.2 Operating environment	13
3.3 Front and back view	14
3.4 Power connections	15
3.5 Interfaces	16
3.6 Cuvette compartments and cuvette adapters	16
3.6.1 Cuvette compartments and adapter	16
3.6.2 Installation of cuvette adapter Z	17
Section 4 Start Up	19
4.1 Switch on the instrument, startup process	19
4.2 Language selection	19
4.3 Self-check	19
4.4 Sleep mode	20
4.5 Power off the instrument	20
Section 5 Standard programs	21
5.1 Overview	21
5.1.1 Tips for using the touch screen	21
5.1.2 Use of the alphanumeric keypad	21
5.1.3 Main menu	22

Table of Contents

5.2 Instrument Setup	23
5.2.1 Operator ID.....	23
5.2.2 Sample ID.....	24
5.2.2.1 Sample ID with hand-held scanner method 1.....	25
5.2.2.2 Sample ID with hand-held scanner method 2.....	26
5.2.2.3 Import sample ID list.....	26
5.2.3 Security settings	27
5.2.3.1 Assign operator security level.....	28
5.2.3.2 Deactivate password	30
5.2.4 Date and time	30
5.2.5 Sound settings.....	32
5.2.6 PC and printer	32
5.2.6.1 Printer setup	33
5.2.6.2 Print data	34
5.2.6.3 Print data continuously	34
5.2.6.4 Network setup.....	35
5.2.7 Power Management	38
5.3 Save, recall, send and delete data	38
5.3.1 Color values	38
5.3.1.1 Automatic/manual color value storage	39
5.3.1.2 Recall color values from the measured data memory	39
5.3.1.3 Send color values from the measured data memory.....	41
5.3.1.4 Delete color values from the measured data memory.....	42
5.3.2 Control charts for data from the AQA Log	42
5.3.3 Data log (only LCS IV).....	43
5.3.3.1 Automatic/manual saving of single and multi-wavelength measurements	44
5.3.3.2 Recall single and multi-wavelength measurements from the measured data memory ...	44
5.3.3.3 Send single and multi-wavelengths from the measured data memory.....	46
5.3.3.4 Delete single and multi-wavelengths from the measured data memory.....	47
5.3.4 Wavelength scan and time course (LCS IV only).....	47
5.3.4.1 Data storage from wavelength scan or time course	48
5.3.4.2 Recall stored data from wavelength scan or time course.....	48
5.3.4.3 Send data from wavelength scan or time course	49
5.3.4.4 Delete stored data from wavelength scan or time course	50
5.3.5 Trends	50
5.4 Take and prepare samples.....	53

5.5 Color measurement	54
5.5.1 Take a color measurement	55
5.5.1.1 Touch-sensitive areas in measurement mode	55
5.5.1.2 Parameter setup options	56
5.5.1.3 Change the color scale after a measurement	57
5.5.1.4 Change the measuring range after a measurement	58
5.5.2 Determination of the iodine color value.....	58
5.5.3 Determination of the Hazen color value (Pt-Co or APHA method)	58
5.5.4 Determination of the Gardner color value	59
5.5.5 Determination of the Mineral oil color value (ASTM D 1500 and ISO 2049).....	59
5.5.6 Determination of the Saybolt color number (ASTM D 156).....	59
5.5.7 Color determinations only by LCS IV	59
5.5.7.1 Color determination according to the European Pharmacopoeia (EP)	59
5.5.7.2 Color determination according to the US Pharmacopoeia (USP)	63
5.5.7.3 Color determination according to the Chinese Pharmacopoeia (CP)	64
5.5.7.4 Determination of the Klett color value	64
5.5.7.5 Determination of the AOCS Cc 13 e (Lovibond®) scale.....	65
5.5.7.6 Determination of the Yellowness Index (ASTM D 1925).....	65
5.5.7.7 Determination of the Hess-Ives color number.....	65
5.5.7.8 Determination of the ADMI color number.....	65
5.5.7.9 Determination of the Acid wash color	66
5.5.7.10 Determination of the ICUMSA color index	66
5.6 Measurement of color differences (LCS IV only)	67
5.6.1 Take a color difference measurement	67
5.6.1.1 View graph/table/values	69
5.6.2 Take a color difference measurement with stored reference values	70
5.6.3 Add a reference to the reference list.....	70
5.7 Photometry (LCS IV only)	71
5.7.1 Single Wavelength (absorbance, concentration and transmittance readings).....	71
5.7.1.1 Set up Single Wavelength mode.....	71
5.7.1.2 Take single wavelength readings (single reading).....	73
5.7.2 Multi Wavelength mode – readings with more than one wavelength.....	73
5.7.2.1 Set the Reading mode at different wavelengths	73
5.7.2.2 Complete a reading in the Multi Wavelength mode	76
5.7.3 Time course of absorbance/transmittance.....	76
5.7.3.1 Time course setup parameters	76
5.7.3.2 Time course scan reading.....	78
5.7.3.3 Analysis of time course data	78
5.7.4 Wavelength Scan mode – recording of absorbance and transmission spectrums	79
5.7.4.1 Set up the wavelength scan	80
5.7.4.2 Perform a wavelength scan	82
5.7.4.3 Work with reference scans.....	83

Table of Contents

Section 6 Advanced Operations	87
6.1 System Checks	87
6.1.1 Instrument Information	87
6.1.2 Update the instrument software	87
6.1.2.1 Software update with USB memory.....	87
6.1.3 Optical Checks	88
6.1.4 AQA Analytical Quality Assurance	89
6.1.4.1 Standard Configuration.....	89
6.1.4.2 Perform AQA Standard Measurement.....	91
6.1.5 Instrument backup.....	91
6.1.6 Service menu	92
6.1.7 Service time.....	92
6.1.8 Lamps operating time	93
6.2 Toolbar	93
6.2.1 Log on	93
6.2.2 Sample ID.....	94
6.2.3 Timer	94
6.2.4 AQA.....	94
6.2.5 Trends	95
Section 7 Maintenance	97
7.1 Cleaning requirements	97
7.1.1 Spectrophotometer.....	97
7.1.2 Screen	97
7.1.3 Cuvettes/cells	98
7.2 Lamp replacement.....	98
7.3 Cell compartment (2) replacement.....	100
Section 8 Troubleshooting	103
Section 9 Service and Certification	107
Index	109

Section 1 Specifications

These are subject to change without notice!

Performance specifications	LCS IV	LCM IV
Display mode	Color measurement, color difference measurement, absorbance and concentration	Color measurement
Color measurement	26 color ratios	5 color ratios
Colorimetric evaluation	All visual color ratios are calculated for standard light chart C and 2° standard observers in accordance with DIN 5033. Colorimetric color values can be switched to light type A, C, D65 and 2° or 10° standard observers.	
Source lamp	Halogen lamp	
Wavelength range	320–1100 nm	
Wavelength Accuracy	± 1.5 nm (wavelength range 340–900 nm)	
Wavelength reproducibility	≤ 0.1 nm	
Wavelength resolution	1 nm	
Wavelength calibration	Automatic	
Wavelength range for color measurement	380–720 nm steps of 10 nm	
Scanning speed	≥ 8 nm/sec (in steps of 1 nm)	
Spectral bandwidth	5 nm	
Photometric measuring range	± 3 Abs (wavelength range 340–900 nm)	
Photometric accuracy	5 mAbs at 0.0–0.5 Abs, 1 % at 0.50–2.0 Ext	
Photometric linearity	< 0.5 % to 2 Abs ≤ 1 % at > 2 Abs with neutral glass at 546 nm	
Stray light	< 0.1 % T at 340 nm with NaNO ₂	
Data log	3000 color measurements, 100 color reference values, 1000 photometric measurements, 20 wavelength scans, 20 time scans	400 color measurements
Physical and environmental specifications		
Width	350 mm (13.78 in)	
Height	151 mm (5.94 in)	
Depth	255 mm (10.04 in)	
Earth	4200 g (9.26 lb)	
Ambient operating requirements	10–40 °C (50–104 °F), maximum 80 % relative humidity (without condensate formation)	
Ambient storage requirements	–40–60 °C (–40–140 °F), maximum 80 % relative humidity (without condensate formation)	
Additional technical data		
Power connector via external power supply	Input: 100–240 V/47–63 Hz Output: 15 V/40 VA	

Specifications

Performance specifications	LCS IV	LCM IV
Interfaces	Use only shielded cable with maximum length of 3 m: 2× USB type A 1× USB type B Use only shielded cable (for example STP, FTP, S/FTP) with maximum length of 20 m: 1× Ethernet	
Housing rating	IP40 (excluding interfaces and power supply)	
Protection class	Class I	

Section 2 General Information

2.1 Safety information

Read through the entire user manual carefully before you unpack the device, set up and put into operation. Pay attention to all danger and caution statements. Failure to do so could result in serious injury to the operator or damage to the equipment.

To make sure that the protection provided by this instrument is not impaired, do not use or install this instrument in any manner other than that specified in these operating instructions.

DANGER

Indicates a potentially or imminently hazardous situation that, if not avoided, results in death or serious injury.

WARNING

Indicates a potentially or imminently hazardous situation that, if not avoided, may result in death or serious injury.

CAUTION

Indicates a potentially hazardous situation that may result in minor or moderate injury.



NOTICE

Indicates a situation that, if it is not avoided, can lead to damage to the device. Information that requires special emphasis.

Note: Information that supplements points in the main text.

2.1.1 Precautionary labels

Read all labels and tags attached to the instrument. Personal injury or damage to the instrument could occur if not observed. For symbols attached to the device, corresponding warning notes are found in the user manual.

	This symbol may be attached to the device and references the operation- and/or safety notes in the user manual.
	This symbol on the device is an indication of hot surfaces.
	Electrical equipment marked with this symbol may not be disposed of in European domestic or public disposal systems after 12 August 2005. In conformity with European local and national regulations (EU Directive 2002/96/EC), European electrical equipment users must now return old or end-of life equipment to the manufacturer for disposal at no charge to the user. Note: For return for recycling, please contact the equipment manufacturer or supplier for instructions on how to return end-of-life equipment, manufacturer-supplied electrical accessories, and all auxiliary items for proper disposal.

⚠ WARNING

The manufacturer is not responsible for any damages due to misapplication or misuse of this product including, without limitation, direct, incidental and consequential damages, and totally excludes such damages as permitted under applicable laws.

The user is solely responsible to identify critical application risks and install appropriate mechanisms to protect processes during a possible equipment malfunction.

2.1.2 Safety around source lamps

The source lamp is operated at high temperatures.

To prevent electric shock, disconnect the instrument from the power source before replacing the lamp.

⚠ CAUTION

Burn hazard. Allow the lamp(s) to cool for at least 30 minutes before maintaining/replacing them.

2.1.3 Chemical and biological safety

⚠ DANGER

Potential danger with contact with chemical/biological substances.

Working with chemical samples, standards and reagents can be dangerous.

Make yourself familiar with the necessary safety procedures and the correct handling of the chemicals before use and read and follow all relevant safety data sheets.

Normal operation of this device may require the use of chemicals or samples that are biologically unsafe.

- Observe all cautionary information printed on the original solution containers and safety data sheets prior to their use.
- Dispose of all consumed solutions in accordance with the local and national regulations and laws.
- Select the type of protective equipment suitable to the concentration and quantity of the dangerous material being used.

2.2 Overview of product

The LCS IV and LCM IV instruments are VIS spectral-photometers with wavelength ranges from 320 to 1100 nm. The instruments can perform a precise colorimetric analysis in accordance with ISO/ASTM standards with a single measurement and display the result in the form of classic color systems such as iodine, Hazen or Gardner color values. The instruments support multiple languages.

The LCS IV is supplied with 26 color value calculations, while the LCM IV is supplied with five color value calculations (Iodine color, Hazen color, Gardner color, Saybolt color and ASTM D 1500 color numbers).

The LCS IV contains the following programs and operating modes in addition to the color measurement: single wavelength mode, multi-wavelength mode, wavelength scan and time scan mode. The digital measurements are displayed in the dimensional units of concentration, absorbance or % transmittance, making the LCS IV universally suitable for lab analysis.

⚠ WARNING

Electrical and fire hazards.
Only use the supplied benchtop power supply LZV844.
Only qualified experts may perform the tasks described in this section of the manual, while adhering to all locally valid safety regulations.

3.1 Unpacking the instrument

The following components are supplied as standard with the LCS IV / LCM IV:

- LCS IV / LCM IV spectrophotometer
- Dust cover
- USB dust cover, fitted as standard
- Table power supply with power cord
- Cuvette adapter Z, installed as standard
- Basic user manual
- CD-ROM with detailed operating instructions

Note: *If any of these items are missing or damaged, please contact the manufacturer or a sales representative immediately.*

3.2 Operating environment

Observe the following points to allow the instrument to function normally and give a long operating life.

- Position the instrument securely on a flat surface taking care to remove any objects from under the device.
- The ambient temperature must be 10–40 °C (50–104 °F).

NOTICE

Protect the instrument from extreme temperatures from heaters, direct sunlight and other heat sources.

- The relative humidity should be less than 80 %; moisture should not condense on the instrument.
- Leave at least a 15 cm clearance at the top and on all sides for air circulation to avoid overheating of electrical parts.
- Do not use or store the device in extremely dusty, humid or wet places.
- Keep the surface of the instrument, the cell compartment and all accessories clean and dry at all times. Immediately remove splashes or spilt materials on or in the instrument (refer to [Section 7](#)).

3.3 Front and back view

Figure 1 Front view

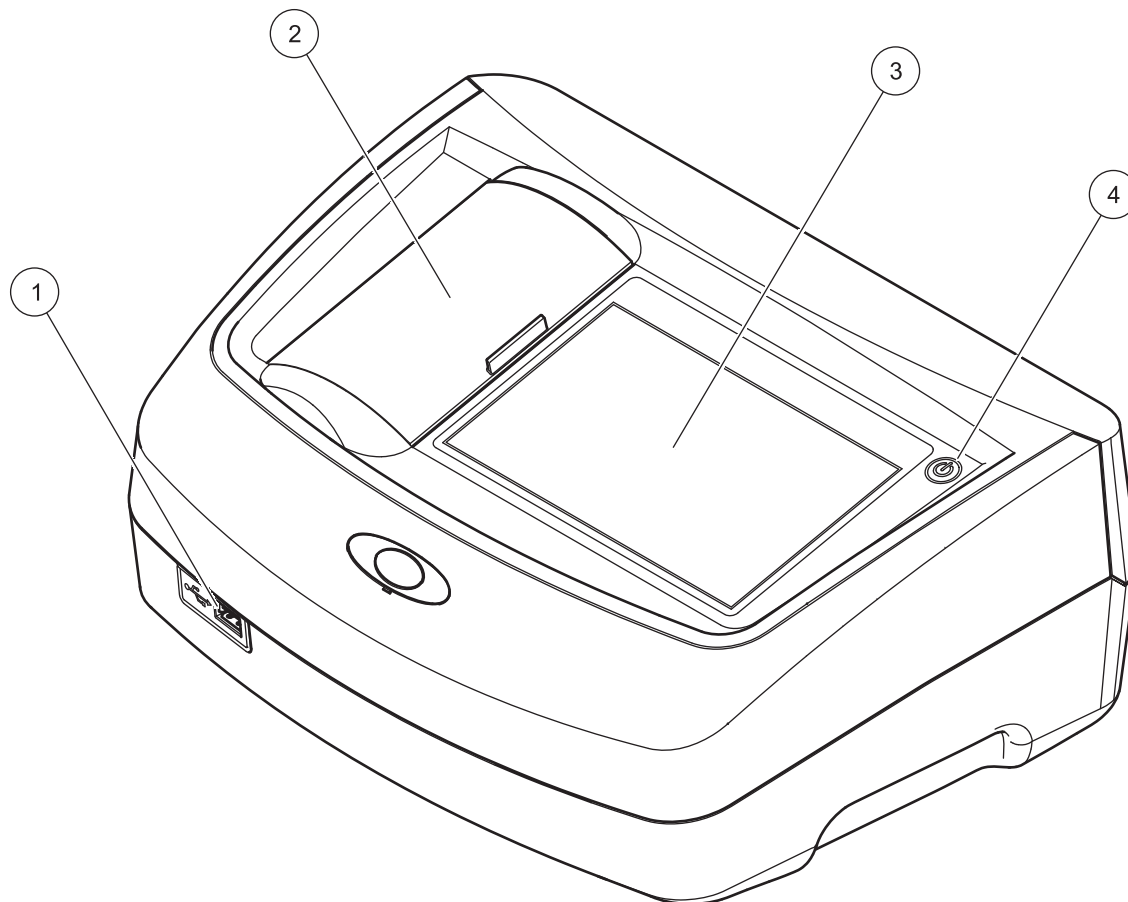

1	USB port type A	3	Touch screen
2	Cuvette compartment cover	4	On/off switch

Figure 2 Back view

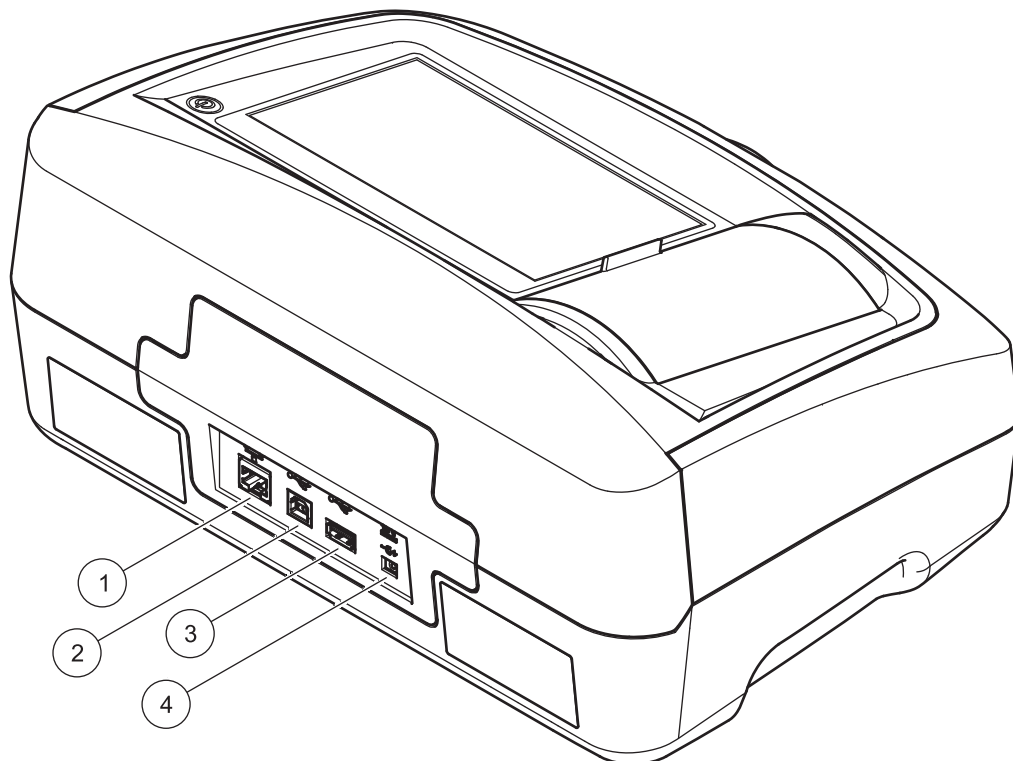

1	Ethernet port	3	USB port type A
2	USB port type B	4	Connection for benchtop power supply

3.4 Power connections

⚠ WARNING

Electrical and fire hazards.
Only use the supplied benchtop power supply LZV844.

1. Connect the power cable to the benchtop power supply.
2. Plug the benchtop power supply cable into the back of the instrument (Figure 2, page 15).
3. Insert the power cable plug into a mains socket (100–240 V~/47–63 Hz).
4. Turn on the power switch next to the screen to activate the power supply (Figure 1, page 14).

Note: If you do not intend to use the instrument for a long period, disconnect it from the power supply.

Note: Make sure the socket you are using is easily accessible.

3.5 Interfaces

The instrument has three USB ports and one Ethernet port as standard. They are located on the front and rear of the instrument (Figure 1 Figure 2, page 15).

The USB type A ports are used for communications with a printer, USB memory stick or keyboard. A USB memory stick can be used to update the instrument software.

The USB type B port is used for communications with a PC. The optional Hach Lange Online Data software must be installed on the PC for this use.

A USB hub may be used to connect several accessories at a time.

Note: *USB cables must not be longer than 3 m.*

These USB ports permit data to be exported to a printer or PC and also allow the instrument software to be upgraded (refer to section 6.1.2, page 87). The Ethernet port supports real-time data transfer in local networks, LIMS systems or SC controllers. Only use a shielded cable (e.g. STP, FTP, S/FTP) with a maximum length of 20 m for the Ethernet port.

Table 1 Interfaces

Interfaces	Description
USB (Type A)	This USB port can be used to connect a printer, a USB memory stick or a keyboard.
USB (Type B)	This USB port is intended only for the connection between the instrument and a PC (when the relevant software is installed).
Ethernet	The Ethernet port is intended for data transfer to a PC without installed software or in a local network . Only use a shielded cable (e.g. STP, FTP, S/FTP) with a maximum length of 20 m for the Ethernet port.

3.6 Cuvette compartments and cuvette adapters

3.6.1 Cuvette compartments and adapter

Open the cuvette compartments by sliding the cuvette compartment cover to the left.

The cover lowers to the side next to the cuvette compartments.

Note: *If there are long intervals between uses, close the cuvette compartment cover to protect the optics of the instrument from dust and impurities.*

The instrument has two cuvette compartments (Figure 3). Only one cell type at a time can be used for a reading.

Cell compartment (1) for:

- 11 mm round cuvettes

Note: *Insert cuvette adapter Z into the cuvette compartment (2).*

Cell compartment (2) for:

The following cell types can be used in cell compartment (2).

- Without cuvette adapter Z in the cuvette compartment (2), you can insert 50 mm cuvettes.
- With cuvette adapter Z: 10 mm square cuvettes.

Note: These cuvettes **must** be inserted with cuvette adapter Z.

Note: In the event of severe contamination, you can replace the cuvette compartment (2) (see chapter 7.3, page 100).

3.6.2 Installation of cuvette adapter Z

1. Open the cuvette compartment.
2. Insert cuvette adapter Z into the cuvette compartment (2) so that the arrow on the cuvette adapter is pointing toward the cuvette compartment (1) (Figure 3).

Note: The arrow on the cuvette adapter indicates the direction of the light beam path.

Installation

Figure 3 Cuvette compartments and cuvette adapter Z

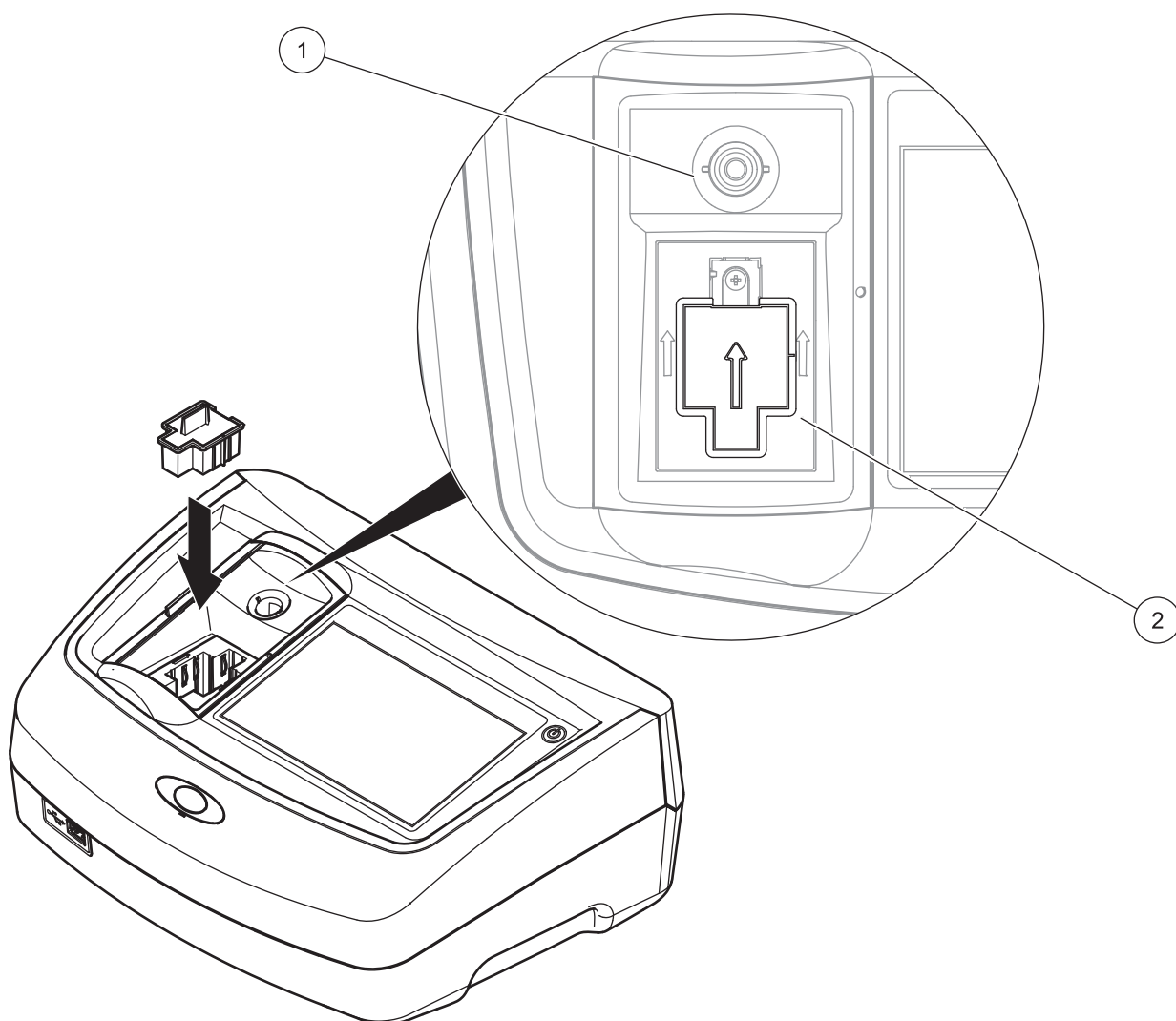

1 Cuvette compartment (1) for round cuvettes

2 Cuvette compartment (2) for square cuvettes, cuvette adapter Z installed

NOTICE

All screen displays in this operating manual correspond to the LCS IV. The screen displays of the LCM IV may differ.

4.1 Switch on the instrument, startup process

1. Connect the power cable to the mains outlet.
2. Switch on the instrument by pressing the power switch next to the screen.
3. The instrument starts automatically with a startup process lasting approximately 45 seconds. The screen displays the manufacturer's logo. At the end of the startup process, a startup melody is heard.

Note: Wait approximately **20 seconds** before switching on again so as not to damage the electronics and mechanics of the instrument.

4.2 Language selection



The software supports multiple languages. The first time the instrument is switched on, the language selection screen will be shown automatically after the startup process.

1. Select the required language.
2. Press **OK** to confirm the language selection. The self-check will then start automatically.

Change the language setting

The instrument functions in the selected language until the option is changed.

1. Turn the instrument on.
2. During the startup process, touch any point on the screen and maintain contact until the option for selecting a language is shown (approximately 45 seconds).
3. Select the required language.
4. Press **OK** to confirm the language selection. The self-check will then start automatically.

4.3 Self-check

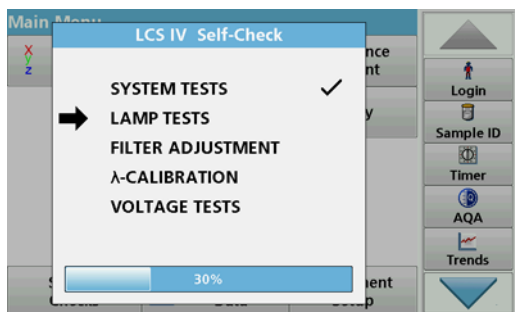

Each time the instrument is powered up, a test program begins.

During the course of this program (approx. 25 seconds), system tests, lamp tests, filter calibration, wavelength calibration and voltage tests can be carried out. Each test that functions correctly is marked accordingly.

Note: For error messages during the test program, refer to [Section 8, page 103](#).

Start Up

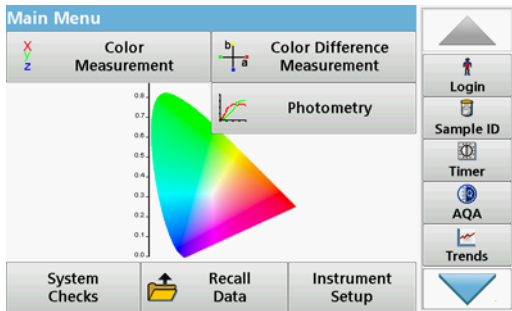

The Main Menu is displayed when diagnostics are completed.

Note: [section 5.1.3, page 22](#) contains a detailed description of the main menu.

4.4 Sleep mode

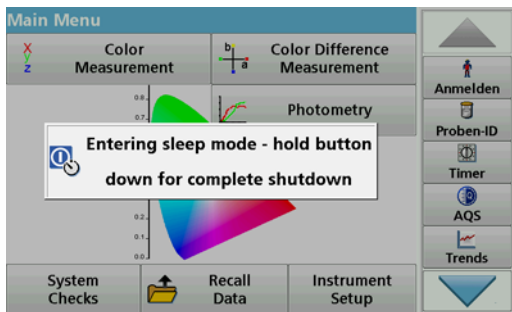

The instrument can be put into sleep mode.

1. Briefly press the power switch next to the screen.

The "Sleep mode" message is shown. The screen will then switch off automatically.

2. To switch on, press the power switch next to the screen. The self-check will start automatically. After that, the instrument is ready to use.

4.5 Power off the instrument

1. Press the power switch next to the screen for approx. 5 seconds.

Section 5 Standard programs

5.1 Overview

5.1.1 Tips for using the touch screen

The whole screen responds to touch. To choose an option, tap with a fingernail, fingertip, an eraser or a specialised stylus. Do not touch the screen with sharp objects, such as the tip of a ballpoint pen.

- Do not place anything on top of the screen, to prevent damage or scratching on the screen.
- Press buttons, words or icons to select them.
- Use scroll bars to move up and down long lists very quickly. Press and hold the scroll bar, then move up or down to move through the list.
- Highlight an item from a list by pressing it once. When the item has been successfully selected, it will be displayed as reversed text (light text on a dark background).

5.1.2 Use of the alphanumeric keypad

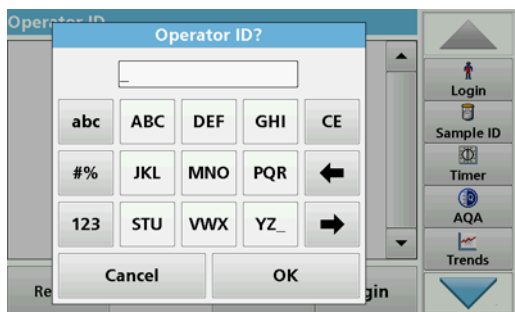

This display is used to enter letters, numbers and symbols as needed when programming the instrument. Unavailable options are disabled (grayed out). The icons on the right and left of the screen are described in [Table 2](#).

The central keypad changes to reflect the chosen entry mode. Press a key repeatedly until the desired character appears on the screen. A space can be entered by using the underscore on the **YZ_** key.

Press **Cancel** to cancel an entry, or press **OK** to confirm an entry.

Note: It is also possible to use a USB keyboard (with US keyboard layout) or a hand-held USB barcode scanner (refer to [Section 9, page 107](#)).

Table 2 Alphanumeric keypad

Icon / key	Description	Function
ABC/abc	Alphabetic	Toggles the character input mode between upper and lower case.
# %	Symbols	Punctuation, symbols and numerical sub- and superscripts may be entered..
123	Numeric	For entering regular numbers..
CE	Clear Entry	Clear the entry.
Left Arrow	Back	Deletes the current character and goes back one position.
Right Arrow	Next	Navigates to the next space in an entry.

Standard programs

5.1.3 Main menu

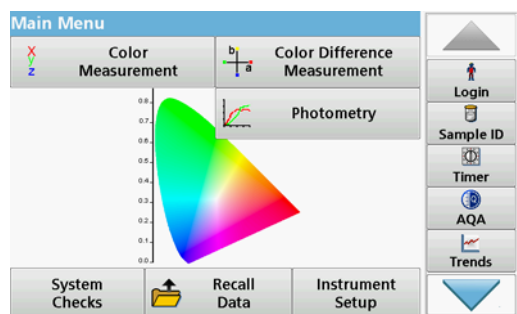

A variety of modes may be selected from the Main Menu. The following table briefly describes each menu option.

There is a toolbar on the right-hand side of the screen. Press to activate the various functions.

Table 3 Main Menu options

Option	Function
Color measurement	The COLOR MEASUREMENT MODE is used to determine color values such as Hazen, Gardner and Saybolt. The LCS IV also offers three-dimensional, absolute colorimetric values, as well as the color scales of CIE L*a*b*, Hunter Lab or the European Pharmacopoeia.
Color difference measurement (only LCS IV)	The mode for COLOR DIFFERENCE MEASUREMENT is used to determine a quantitative color difference between a reference (R) and a sample (P) in the three-dimensional color space (CIE L*a*b* or Hunter Lab). In this mode, an additional reference memory for up to 100 references is available.
Photometry (only LCS IV)	Single Wavelength Single wavelength readings are: Absorbance readings: The light absorbed by the sample is measured in absorbance units. Transmittance reading (%): Measures the percent of the original light that passes through the sample and reaches the detector. Concentration readings: A concentration factor can be entered to enable the measured absorbance values to be converted into concentration values.
	Multi Wavelength In the Multi Wavelength mode, absorbance (Abs) or percentage transmittance (%T) is measured at up to four wavelengths and absorbance differences and absorbance relationships are calculated. Simple conversions into concentrations can also be carried out.
	Time course The time scan records the absorbance or % transmittance at a wavelength over a defined time.
	Wavelength Scan A wavelength scan shows how the light from a sample is absorbed over a defined wavelength spectrum. This function can be used to determine the wavelength at which the maximum absorbance value can be measured. The absorbance behavior is displayed graphically during the scan.
System Checks	The "System Check" menu contains a number of options, such as instrument information, optical checks, instrument backup, service times, instrument update, settings for analytical quality assurance and lamp history.
Recall measurement data	Saved data can be retrieved, filtered, sent to a printer, memory stick or PC and deleted.
Instrument Setup	This menu is used to configure user-specific and/or process-specific settings: operator ID, date and time, security settings, saved data, sound, PC and printer and energy management.

5.2 Instrument Setup

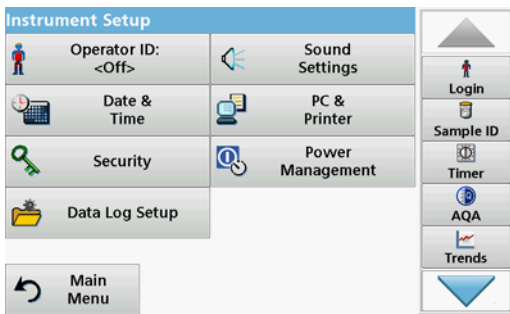

1. In the main menu, select the menu option **Instrument setup**.
A selection of functions appears in order to configure the functions of the instrument.

5.2.1 Operator ID

Use this option to enter up to 30 sets of operator initials (up to ten characters each) into the instrument. This feature helps record which operator measured each sample.



1. Press **Operator ID** in "Instrument setup".
2. Press **Options > New** to enter a new operator ID.
Note: If no operator ID has yet been entered, the alphanumeric keyboard is immediately displayed.
3. Use the alphanumeric keypad to enter a new operator ID.
4. Press **OK** to confirm the entry.



5. Choose an icon for the operator ID using the **Left Arrow** and **Right Arrow**.
6. Press **Operator password** to protect the operator ID with a password.
7. Use the alphanumeric keypad to enter an operator password.
8. Press **OK** to confirm the entry.



9. Press **Cancel** to delete the complete entry for the operator ID.
Press **Back** to reach to the input screen for operator ID.
Press **OK** to confirm the entry. The following screen is displayed.

Standard programs

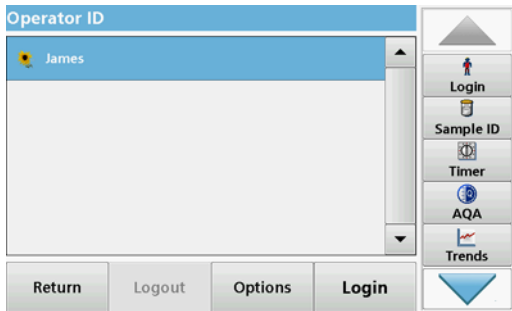

10. With **Back** the device returns to the menu "Instrument Setup".
Press **Logout** to log out of an active operator ID.
Press **Login** to activate a selected operator ID.
Press **Options** to enter, change or delete additional operator IDs. The following screen is displayed.

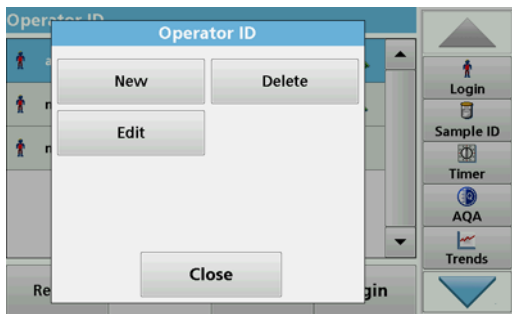

11. Press **New** to enter another operator ID.
Press **Delete** to delete an operator ID.
Press **Edit** to edit an operator ID.

5.2.2 Sample ID

Use this option to enter up to 100 different sample designations (up to 20 characters each) into the instrument. Sample IDs can be used to specify the sample location or other sample specific information, for example.

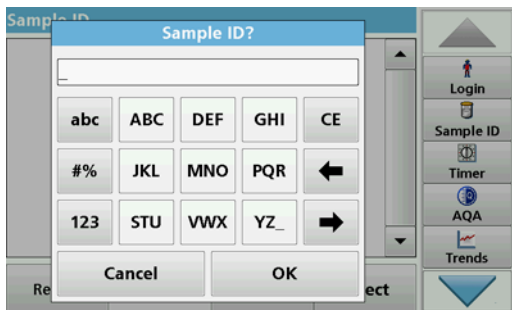

1. Press **Sample ID** in the toolbar on the right.
2. Press **New** to enter a new sample ID.

Note: If no sample ID has been entered yet, the alphanumeric keyboard is immediately displayed.

3. Use the alphanumeric keypad to enter a new Sample ID.

Note: If a USB Barcode handset scanner (refer to [section 5.2.2.1, page 25](#)) is connected, Sample IDs can also be scanned.

4. Press **OK** to confirm the entry.

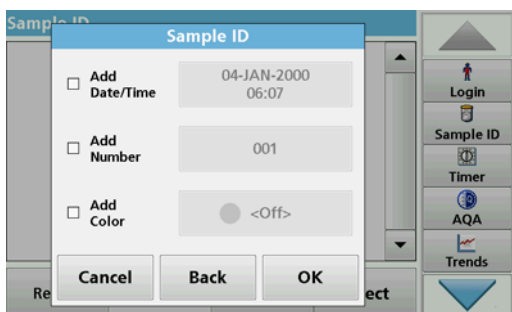

5. Assign the current time and date, a sequential number or a colour to the sample ID.

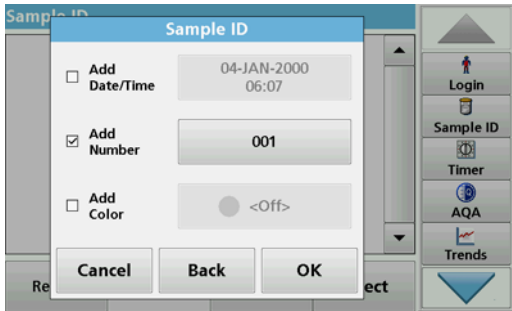

6. To number the sample IDs sequentially (e. g. Inflow (01) etc.), press **Add Number**.
 - Use the arrow keys to specify the first number of the sequence.
 - Use the key between the arrow keys to enter the first number of the sequence using the alphanumeric keypad.
7. Press **OK** to return to the "Instrument Setup" menu.

The Sample ID is activated. Each Sample ID is automatically numbered in ascending order after a reading. The number is shown in parentheses behind the Sample ID.

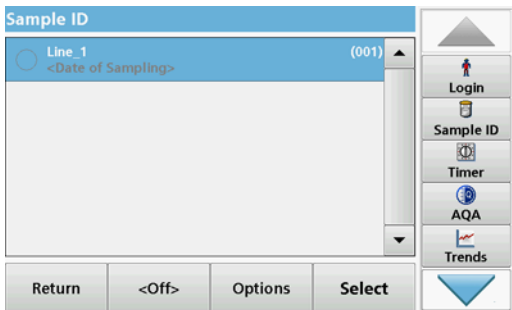

8. Press **Back** to return the instrument to the "Instrument Setup" menu. Press **Off** to switch off the active sample ID. Press **Select** to activate the selected sample ID. Use **Options** to enter, change or delete additional sample IDs. The following screen is displayed:



9. Press **New** to enter another sample ID. Press **Delete** to delete a sample ID. Press **Edit** to edit a sample ID. Select **Import Sample ID List** to import *.txt and *.csv files via a USB stick or network; see [section 5.2.2.3, page 26](#).

5.2.2.1 Sample ID with hand-held scanner method 1

1. Connect the hand-held scanner to the USB port. Successful connection is indicated by a sound.
2. Press **Sample ID > Options** and **NEW**.
3. Read barcode with hand-held scanner.

Standard programs

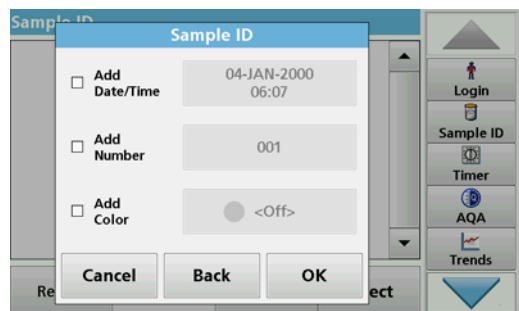

4. The sample ID can have the current date and time, a sequential number and a colour allocated to it. Select the required options or a colour.

5. Press **OK** to confirm the entry.

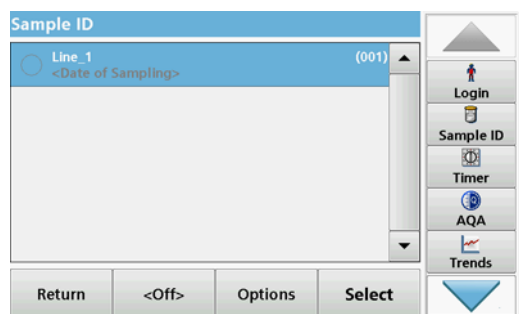

6. Press **New** again and repeat the process for each barcode.

5.2.2.2 Sample ID with hand-held scanner method 2

1. Read the sample ID in measurement mode with the hand-held scanner and calibrate the cuvette.

The sample ID is saved together with the measured value but is not transferred to the list of sample IDs.

Note: To delete a sample ID, activate the ID by selecting it and pressing **Delete**.

Note: A sample ID can be entered or changed in Reading Mode. To do this, press **Options** > **More** > **Instrument Setup**. If a sample ID is already assigned, select the "Sample ID" symbol.

5.2.2.3 Import sample ID list

1. Create an external sample ID list with a spreadsheet program.

Four columns are permitted; column 1 contains the sequential number, column 2 the sample designation, columns 3 and 4 are optional.

Headings and comment lines must begin with #.

2. Create a folder named "Sample ID" on a USB stick or in your established network.

3. Save the sample ID list with **Save As** in the format CSV or UNICODE-TXT in the folder "Sample ID".

4. Connect the instrument to the USB stick or network.

All *.TXT and *.CSV files in the Sample ID folder will be displayed for selection.

5. Select the desired file with **OK**.
6. Transfer the displayed sample ID list with **DONE**.

5.2.3 Security settings

The "Security" menu contains a variety of security settings to control access to various functions.

All functions can be allocated to three different security levels:

- **not secured**: every operator can make changes in this area.
- **one key**: every operator assigned this security level can make changes to non-secured functions and functions with one key.
- **two keys**: every operator assigned this security level can make changes in all functions

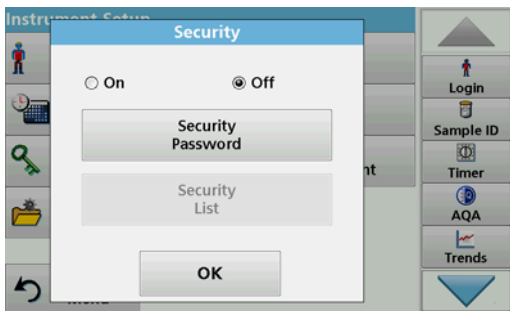

1. Press **Security** in the "Instrument Setup" menu.
2. In order to open the **Security List**, assign a password as security administrator. Press **Security Password**.



3. Enter a new security password (up to 10 characters long) via the alphanumeric keypad, and confirm with **OK**.

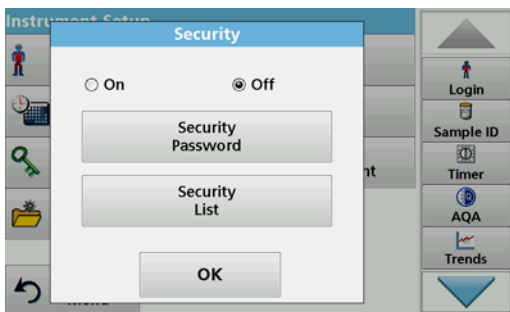

4. Press **Security List** to access various functions with security level 1 or 2.

Standard programs

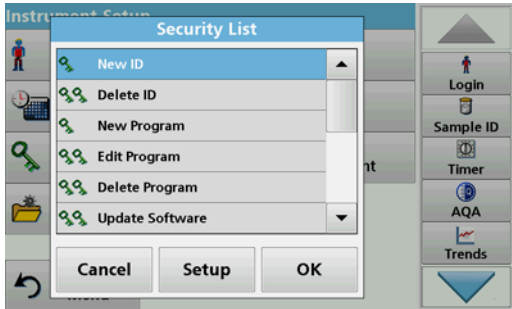

5. Select the required function and press **Setup**.

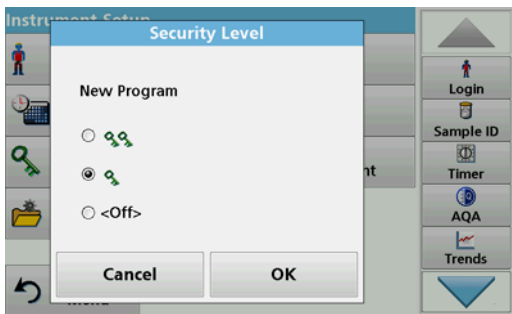

6. Select the required security level (two keys, one key or off) and confirm using **OK**.

7. Press **OK** to return to the "Security" menu.



8. Press **On** to activate the new settings of the security list.

9. Press **OK** to return to the "Instrument Setup" menu.

Note: The alphanumeric keypad for entering the password appears when a user tries to reach a locked setting.

5.2.3.1 Assign operator security level

Every operator with an operator ID can be assigned a security level. This assignment is connected to the operator password. Setup must be coordinated with the security administrator and the operator.



1. Press **Operator ID** in "Instrument setup".

2. Enter the security password and confirm with **OK**.

3. Set up an operator ID (refer to [section 5.2.1](#)).



4. Press **Operator Password**.
5. Enter the operator password and confirm with **OK**.



6. Press **Security Level: <Off>**.
7. Enter the security password and confirm with **OK**.

The current security level for the selected operator is shown.

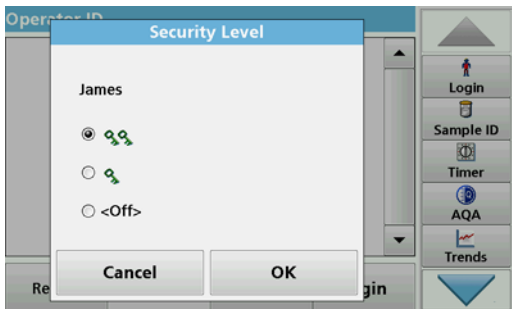

8. Select the required security level for this operator ID and confirm with **OK**.



9. Press **OK**.

Standard programs

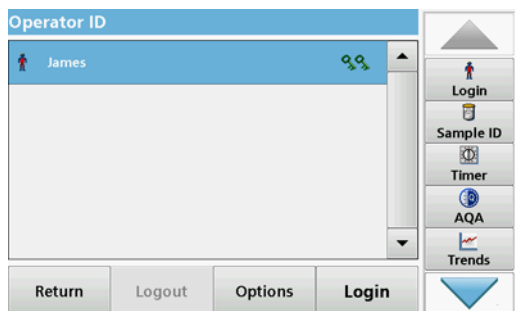

The operator ID is displayed with the selected security level.

10. Activate the selected operator ID by pressing **Login**.
11. Enter the operator password.
12. Confirm with **OK** and return to "Instrument Setup".

5.2.3.2 Deactivate password



1. Press **Security** in the "Instrument Setup" menu.
2. Enter the security password and confirm with **OK**.

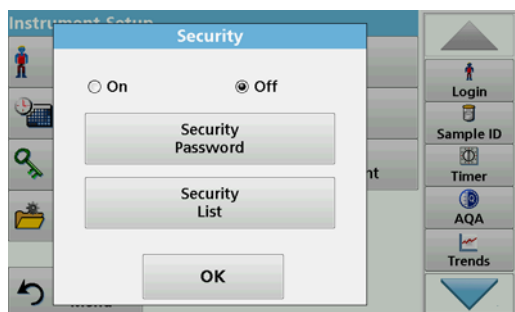

3. Press **Off** to deactivate the settings of the Security List.
4. Press **OK** and return to the "Instrument Setup" menu.

Note: Use this function to delete the former password or to enter a new one.

5.2.4 Date and time

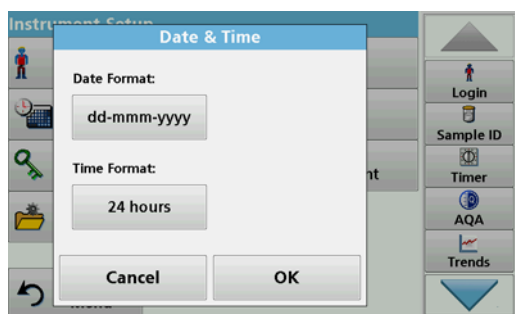

1. Press **Date and Time** in "Instrument setup".

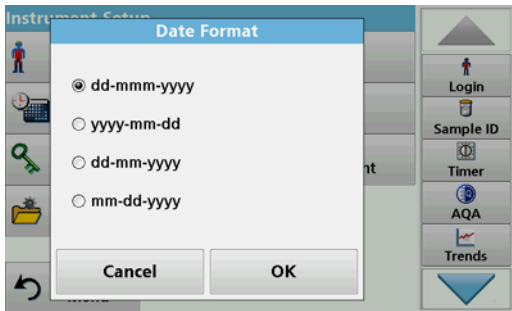

2. Press **Date Format** for the date.
3. Press **OK** to confirm the entry.

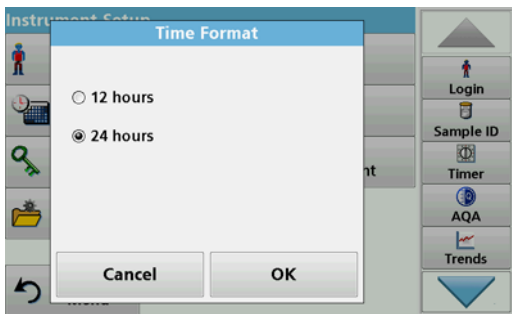

4. Press **Time Format** for the time.
5. Press **OK** to confirm the entry.

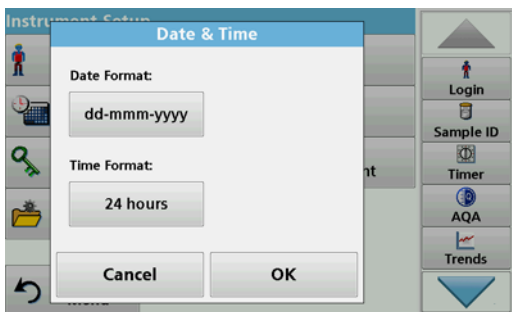

6. Press **OK** to confirm the entry.

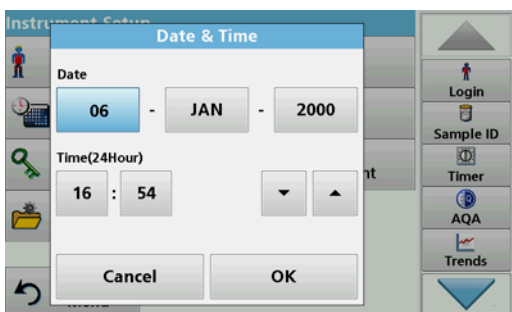

7. Enter the current date and time. Change the information using the arrow keys.
8. Press **OK** to confirm the entry.

The instrument then returns to "Instrument Setup".

5.2.5 Sound settings

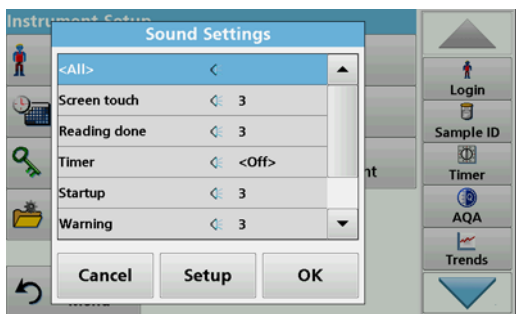

1. Press **Sound Settings** in "Instrument Setup".

The following options will be displayed:

- **All:** Activates/deactivates a sound with a variable volume for every function, with the exception of the timer.
- **Touch screen:** Activates/deactivates a short sound with variable volume every time the screen is touched.
- **Reading done:** Activates/deactivates a short sound with variable volume when the reading is done.
- **Timer:** Sets short/long sound with variable volume when timer has ended.
- **Startup:** Activates/deactivates a startup melody with variable volume when the test program is started.
- **Warning:** Activates/deactivates a short sound with variable volume if there is an error message.
- **Shutdown:** Activates/deactivates a short sound with variable volume when shutting down.

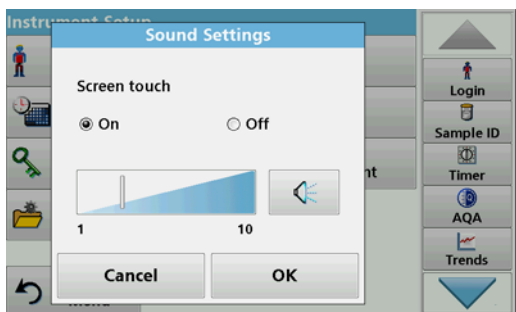

2. Select the required action.
3. Press **Setup** and complete the required settings.
4. Press **OK** to confirm the entry.
5. Press **OK** to confirm the entry.

The instrument then returns to "Instrument Setup".

5.2.6 PC and printer

As standard, the instrument has one Ethernet port and 2 USB ports on the rear of the instrument, as well as one USB port on the front (see [Figure 1](#) and [Figure 2, page 15](#)). These interfaces can be used for exporting data and graphics to a printer, updating data and transferring data to a PC and in a network. They are intended for connecting a USB memory, an external USB keypad or a USB barcode hand-held scanner.

Note: With a USB hub, you can connect various accessory instruments at the same time.

A USB memory stick is used to update data, refer to [section 6.1.2, page 87](#).

Note: A shielded **USB cable** must not be longer than **3 m!**

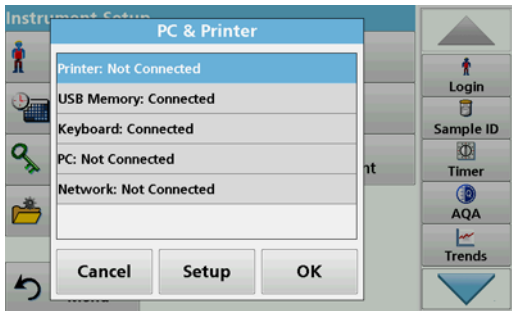

1. Press **PC & Printer** in "Instrument Setup".
A list with information about the connections opens.

5.2.6.1 Printer setup

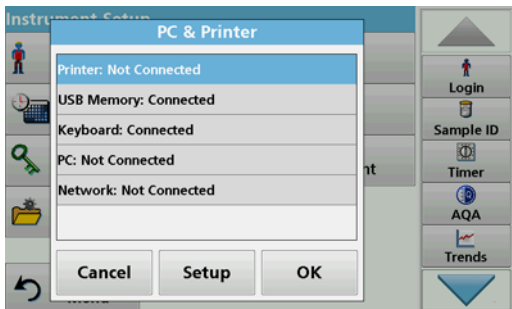

2. Press **Printer**.
3. Press **Setup** to display the Printer Setup screen.



Printer Setup:

- Resolution: Font size
- Paper: Paper size
- Network Printer: Automatic printer search or fixed input via IP address.

Note: If an optional Thermal Printer is connected, the function "Auto Send" on/off is available.

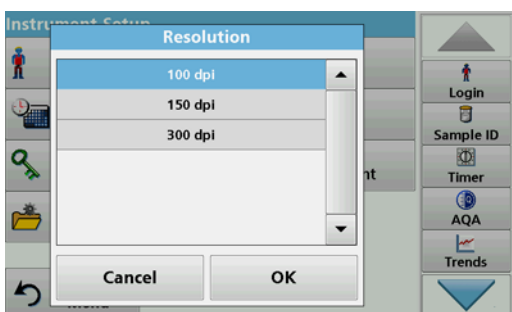

4. Press **Resolution** to select the print quality.

Select between:

- 100 dpi,
- 150 dpi and
- 300 dpi.

5. Press **OK** to confirm the entry.

Note: Press **OK** again to return to the "Instrument Setup" menu.

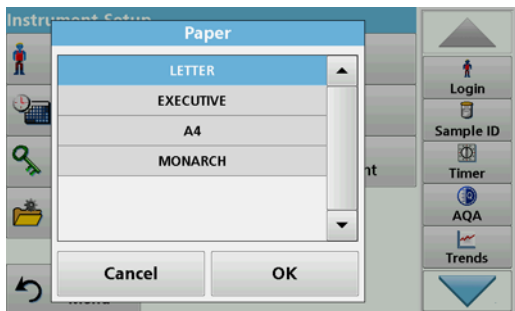

6. Press **Paper** to select the paper size.

Select between:

- Letter,
- Monarch,
- Executive,
- A4.

7. Press **OK** to confirm the entry.

Note: Press **OK** again to return to the "Instrument Setup" menu.

5.2.6.2 Print data

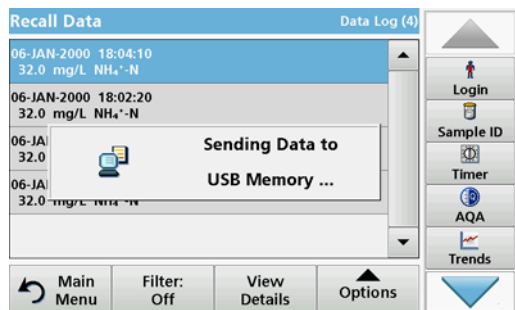

1. In the main menu, press the **Recall Data** menu option.
2. Select the data source, where the data to be printed are stored.

A list is displayed. Data can be filtered. Refer to [section 5.3.1.2, page 39](#) for more information.

3. Press the **Send Data** symbol to transmit data (table, curve) directly to the printer.
4. Highlight **Single point**, **Filtered data** or **All data** and press **OK** to confirm.

Sending data... **appears on the screen** until the data is printed.

5.2.6.3 Print data continuously

If you would like to automatically print out all measured values immediately after measurement, the use of a continuous form printer is recommended, for example the 4" paper thermal printer refer to [Section 9, page 107](#).

1. Connect the thermal printer to a USB type A port.
2. Press **PC and Printer** in the "Instrument Setup" menu.

A list with information about the connections opens.

3. Highlight **Printer**.
4. Press **Setup** to display the Printer Setup screen.
5. Select **Auto-Send: On** to send all measured data automatically to the Thermal printer.

5.2.6.4 Network setup

The instrument supports communication in local networks. For the setup of an Ethernet communication in networks, a special configuration is required. The manufacturer recommends support from a network administrator. Only use a shielded cable (e.g. STP, FTP, S/FTP) with a maximum length of 20 m for the Ethernet port. This section describes the setting options for the photometer in relation to network communication.

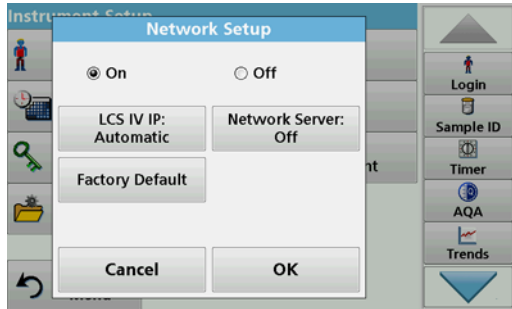

The connection parameters must be configured for data transfer to a PC or connection to a network.

1. Press **PC & Printer** in "Instrument Setup".
2. Press **Network > Setup**.
3. Press **On** and then **LCS IV IP: Automatic**.

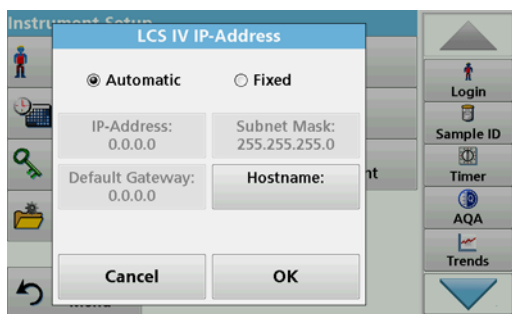

4. Press **IP address**.

An IP address is used to send data from a sender to a pre-defined recipient.

- If the IP for the instrument is automatically assigned in the network, no further settings are necessary. A hostname can optionally be assigned.
- If the instrument address is fixed, the connection must be configured.

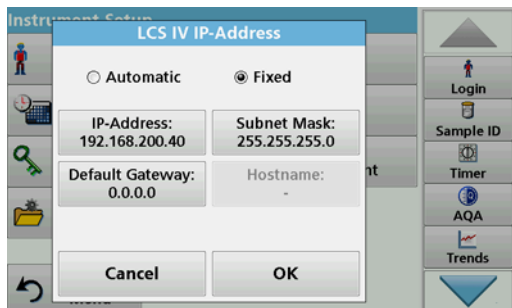

5. To configure the IP address, press **Fix**.

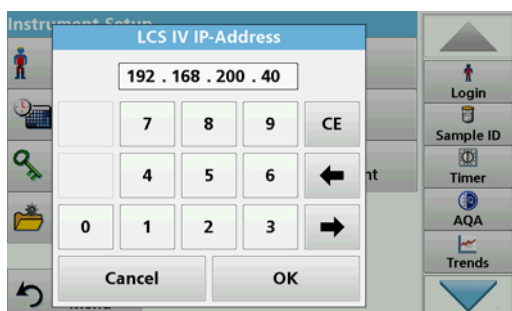

6. Press **IP address** and enter the address.

Standard programs



In conjunction with the IP address of an instrument, the subnet mask establishes which IP addresses are located within the local network.

7. Press **Subnet Mask** and enter the address.



A Gateway enables data communication in networks that are based on varying protocols.

8. Press **Default Gateway** and enter the address.
9. Press **OK** to confirm the entry.

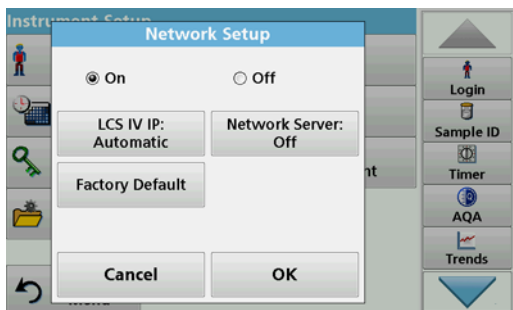

10. Press **Network Server** to determine the destination for the data transmission.

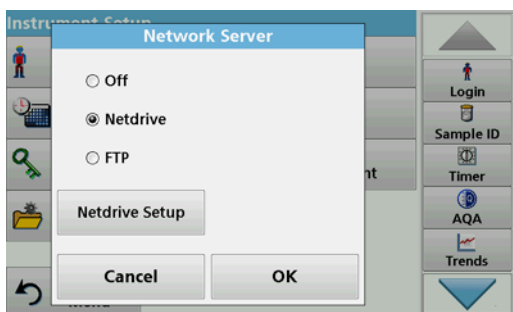

11. Press **Netdrive** and run a netdrive setup. Alternatively, select **FTP** and run FTP Setup. The procedures are completely identical. As an example, Netdrive Setup is described here.

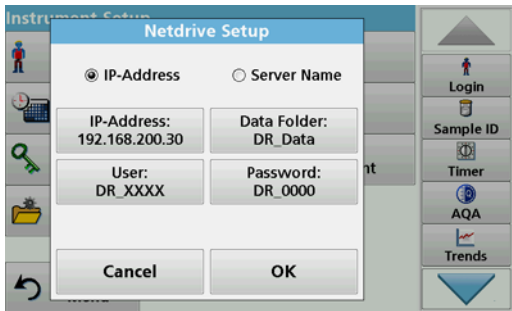

The target site can be defined by IP address or a server name.

12. Press **IP-Address** and enter the IP address or select **Server Name** and enter a server name.

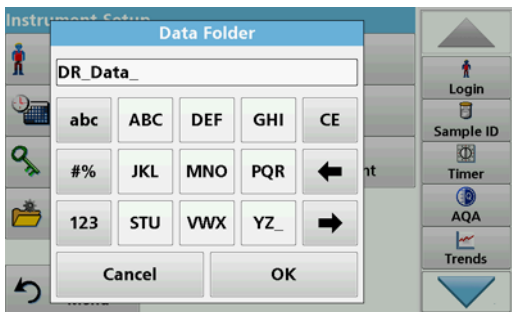

13. Press **Data Folder** and enter the target folder name.

Note: A folder with the selected name must exist on the target system. Additionally, the folder must be shared with the operator, using the corresponding password.

14. Press **OK** to confirm the entry.



User and **password** must be identical to the settings on the target system.

15. Press **User** and enter the user designation.
16. Press **OK** to confirm.
17. Press **Password** and enter the password.
18. Press **OK** to confirm the entry.

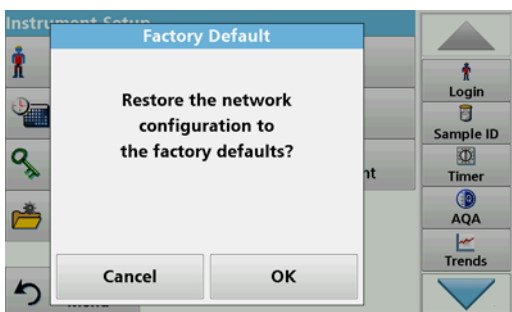

19. Press **Factory Default** to restore the network configuration to the factory defaults.

5.2.7 Power Management

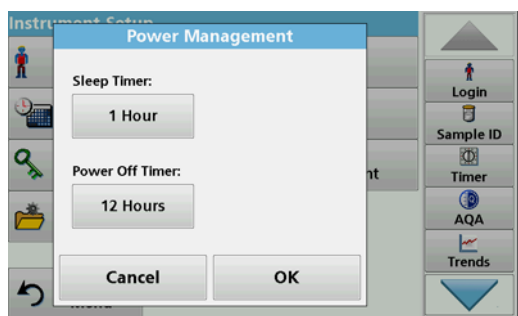

1. Press **Power Management** in "Instrument setup".
2. Press **Sleep Timer** and then **OK**.

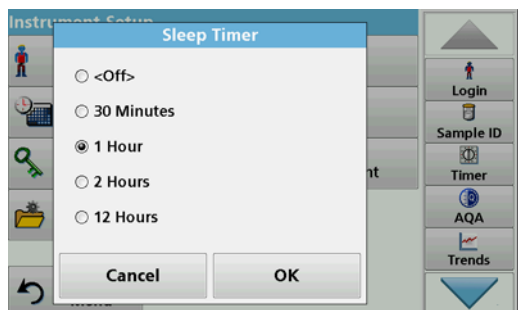

3. Select the required time span after which the instrument will go into energy-saving sleep mode if it is not used (refer to [section 4.4, page 20](#)), and confirm with **OK**.

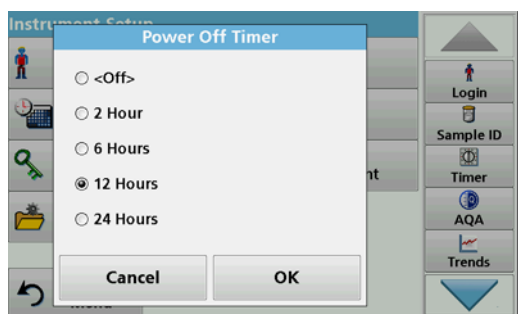

4. Press **Power Off Timer** and then **OK**.
5. Select the required time span after which the instrument will automatically be powered off if it is not used, and confirm with **OK**.
6. Press **OK** to confirm the entry.

The instrument then returns to "Instrument Setup".

5.3 Save, recall, send and delete data

Up to 3000 color measured values (400 color measured values for LCM IV) can be saved in the measured data memory.

In addition, the LCS IV can store 100 reference color measurements, 1000 single and multi-wavelength measurements, 20 wavelength scans and 20 time scans.

A complete record of the analysis is stored, including the Date, Time, Results, Sample ID and Operator ID.

5.3.1 Color values

Measurement results from the color measurement can be found under **Recall Data > Color Log**.

5.3.1.1 Automatic/manual color value storage

The data storage function indicates whether data is to be stored automatically or manually (in the latter case, the user must decide which data is to be saved).

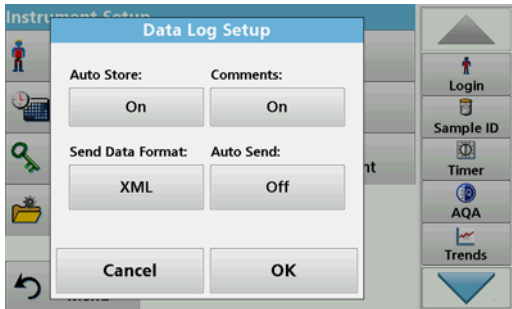

1. Press **Data Log Setup** in the "Instrument Setup" menu.
 - With the **Auto Store: On** setting, the instrument automatically saves all the calculated measured data "after the measurement" or alternatively "after removing the cuvette".
 - With the **Auto Store: Off** setting, the instrument saves no measured data automatically. In measurement mode, select **Options > Save** to save the currently displayed measured value.
2. Specify the output format of data to be exported using **Send Data Format**. Select **xml** or **csv**.
3. Press **OK** to confirm the entry.

The instrument then returns to "Instrument Setup".

Note: When the measured data memory of the device has reached its maximum storage capacity, the oldest data record is automatically deleted so that the new data can be saved.

5.3.1.2 Recall color values from the measured data memory

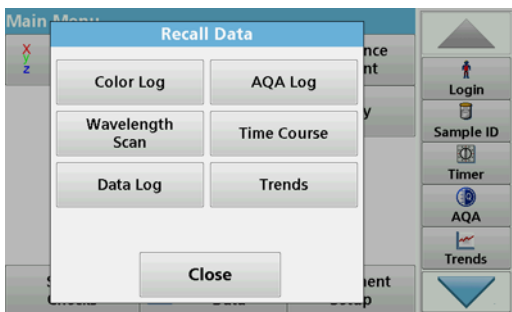

1. In the main menu, press the **Recall Data** menu option.

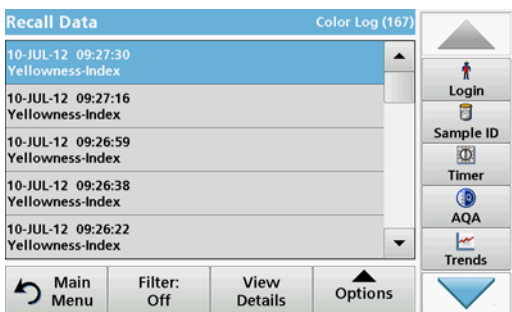

2. Press **Color Log**.

A listing of the stored data is displayed.

Standard programs

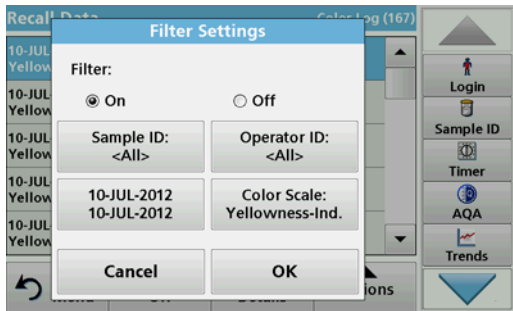

3. Press **Filter: On/Off**.
The function **Filter Settings** is used to search for specific items.
4. Activate **On**. The data can now be filtered using the following selection criteria.
 - Sample ID
 - Operator ID
 - Start Date
 - Color Scale
 or any combination of the four.

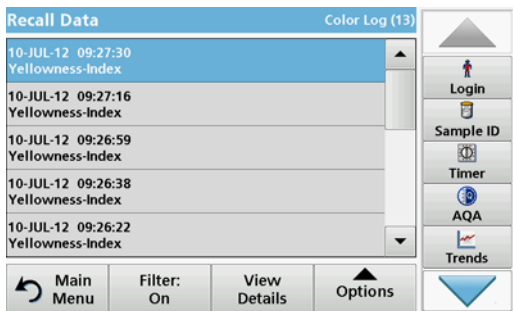

5. Press **OK** to confirm the selection.
The chosen items are listed.

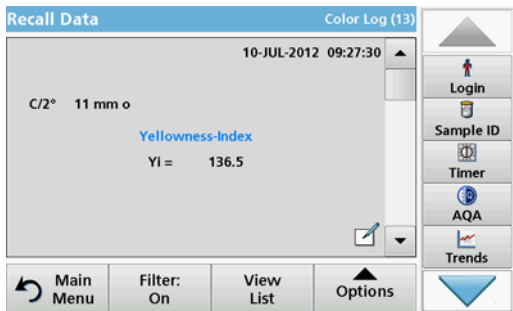

6. Press **View Details** to get more information.

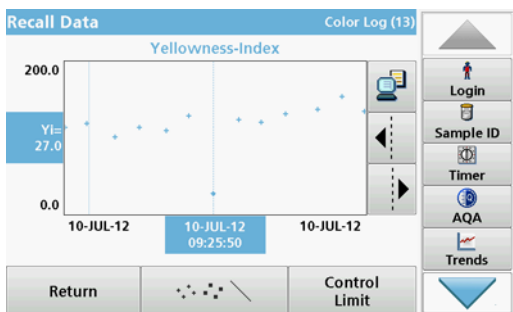

7. Press **Options** and **Graph Data**.
A graphic trend of all color values stored in the selected period and color system is displayed. The trend shows a visual impression of the measured process values, e.g. during production supervision in the shift operation.
8. Press the **arrow buttons** on the right of the graph to move the dotted cursor line inside of the trend graph to the different measurement values. The color value of the marked measurement is shown on the left vertical axis and the date/time of this measurement is shown below the horizontal axis.

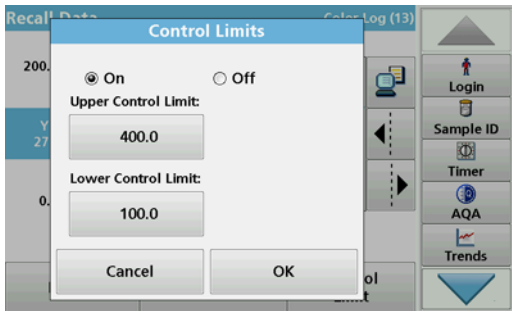

9. Press **Control Limit**.

10. Highlight **On** to change the **Upper Control Limit** and the **Lower Control Limit** settings.

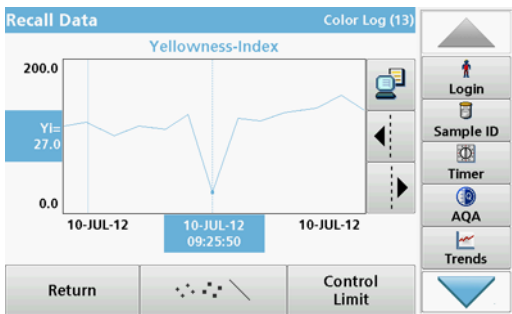

11. The **measured points symbol** changes the display of the measured points.

5.3.1.3 Send color values from the measured data memory

Data is sent from the internal data memory as an XML file (Extensible Markup Language) or as CSV files (Comma Separated Value) to a USB mass storage device or to a network, to a directory with the name ColorLog. The file can then be processed using a spreadsheet program. The file name has the following format: CL_Instrument Type_Serial Number_Year-Month-Day_Hour_Minute_Second.csv or CL_Instrument Type_Serial Number_Year-Month-Day_Hour_Minute_Second.xml.

To send data to a printer, refer to [section 5.2.6.2, page 34](#).

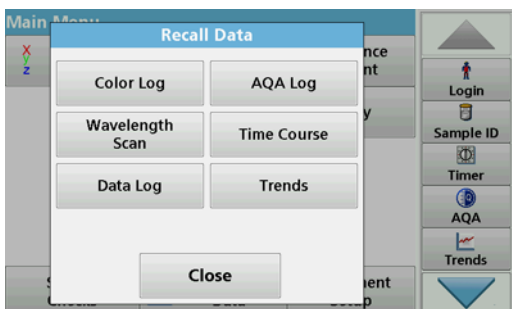

1. Plug the USB memory stick into the USB-A port on the instrument or connect the instrument to a network drive (see [section 5.2.6.4, page 35](#)).

2. In the main menu, press the **Recall Data** option.

3. Select the data category to be transferred, e. g. **Color Log**.

A list of the selected measurement data is displayed.

Standard programs

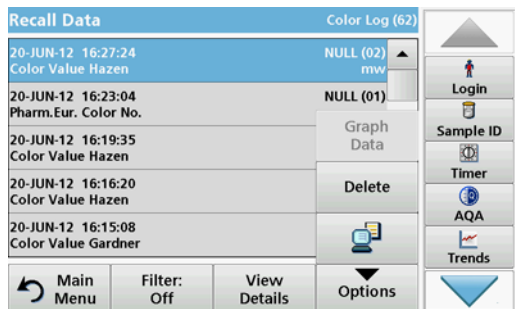

4. Press **Options** and then the **PC & Printer** icon.

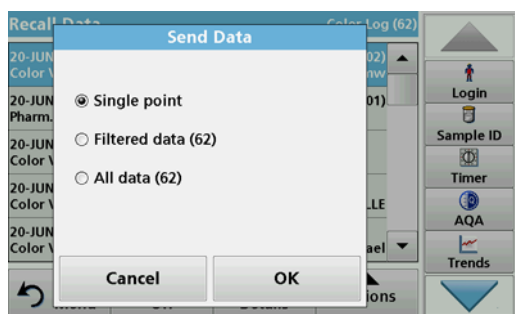

5. Select the data to be sent.
The following options are available:

- **Single point:** only this selected reading will be sent
- **Filtered data:** only readings that correspond to the set filters will be sent
- **All data:** all data in the selected data category will be sent.

6. Press **OK** to confirm.

Note: The number in parentheses is the total number of data sets assigned to this selection.

5.3.1.4 Delete color values from the measured data memory

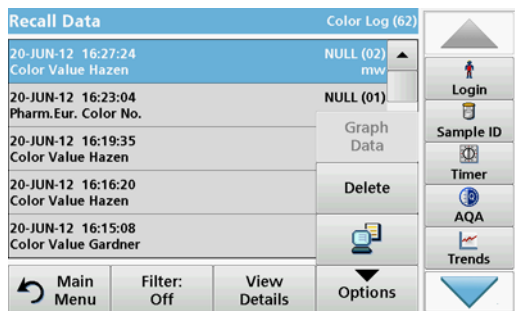

1. In the main menu, press the **Recall Data** menu option.
2. Press **Color Log > Options > Delete**.
3. Highlight **Single point**, **Filtered data** or **All data** and press **OK** to confirm.

Note: The number in parentheses is the total number of data sets assigned to this selection.

5.3.2 Control charts for data from the AQA Log

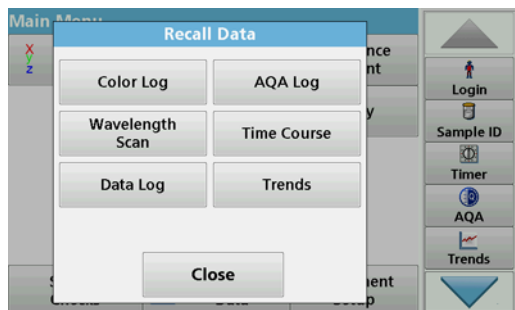

1. In the main menu, press the **Recall Data** menu option.

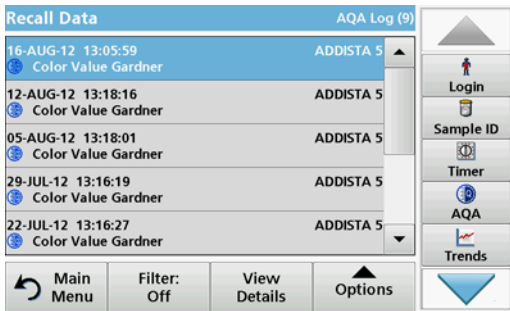

2. Press **AQA Log**.

A listing of the stored data is displayed.

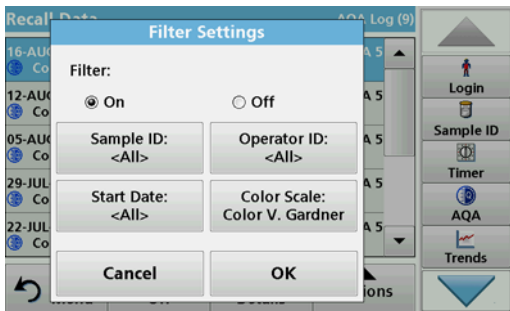

3. Press **Filter: On/Off**.

4. Activate **On**.

5. Select a required parameter.

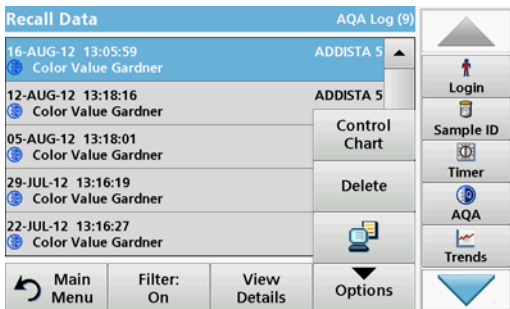

6. Press **OK** to confirm the selection.

The chosen items are listed.

7. Press **Options > Control Chart**.

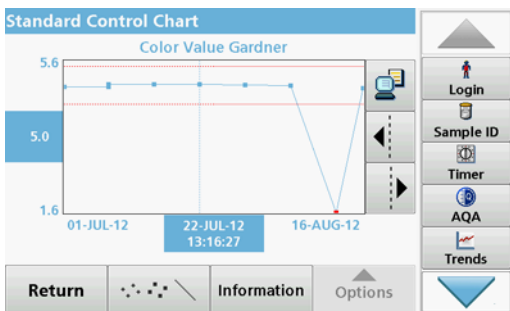

The measured standard concentrations are displayed graphically with the control limits and date.

5.3.3 Data log (only LCS IV)

Measurement results from the photometric measurements of single and multi-wavelengths can be found under **Recall Data Data Log**.

Standard programs

5.3.3.1 Automatic/manual saving of single and multi-wavelength measurements

The data log function indicates whether data is to be stored automatically or manually (in the latter case, the user must decide which data is to be saved).

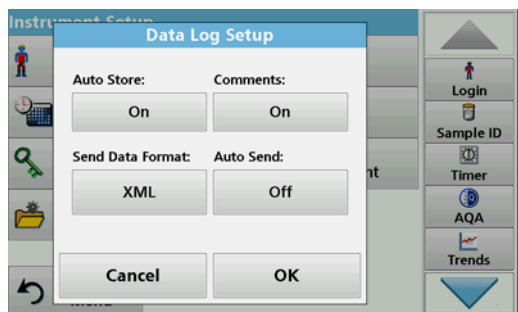

1. Press **Data Log Setup** in the "Instrument Setup" menu.
 - With the **Auto Store: On** setting, the instrument automatically saves all the calculated measured data "after the measurement" or alternatively "after removing the cuvette".
 - With the **Auto Store: Off** setting, the instrument saves no measured data automatically. In measurement mode, **Options > Save** can be used to save the currently displayed measured value.
2. Specify the output format of data to be exported using **Send Data Format**. Select **xml** or **csv**.
3. Press **OK** to confirm the entry.

The instrument then returns to "Instrument Setup".

Note: When the measured data memory of the instrument has reached its maximum storage capacity, the oldest data record is automatically deleted so that the new data can be saved.

5.3.3.2 Recall single and multi-wavelength measurements from the measured data memory

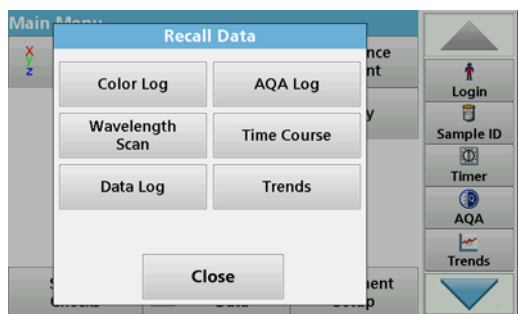

1. In the main menu, press the **Recall Data** menu option.

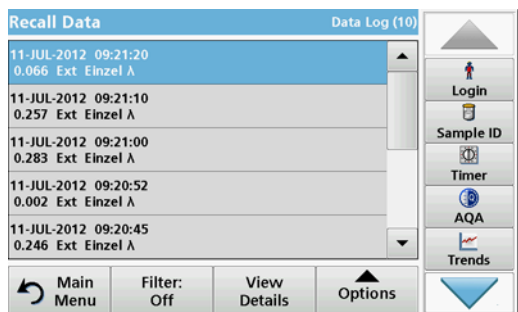

2. Press **Data Log**.

A listing of the stored data is displayed.

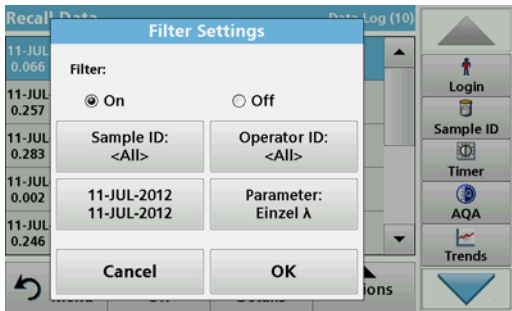

3. Press **Filter: On/Off**.
The function **Filter Settings** is used to search for specific items.
4. Activate **On**. The data can now be filtered using the following selection criteria.
 - Sample ID
 - Operator ID
 - Start Date
 - Parameter (Single or multi-wavelength)
 or any combination of the four.

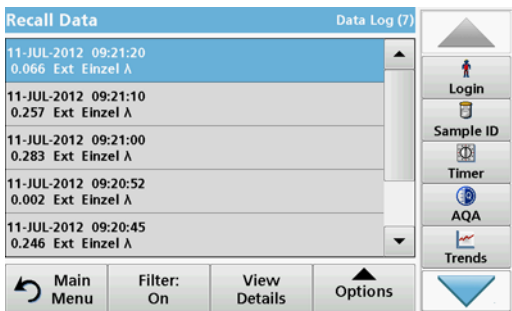

5. Press **OK** to confirm the selection.
The chosen items are listed.

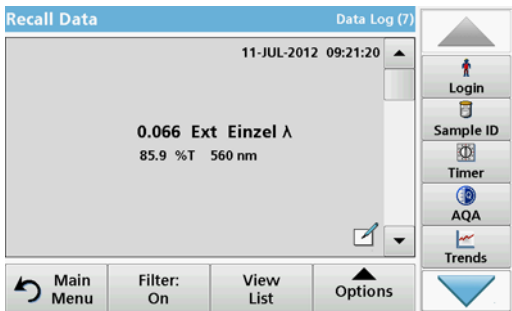

6. Press **View Details** to get more information.

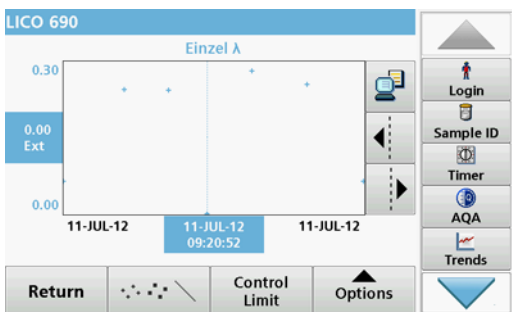

7. Press **Options** and **View Graph**.
A graphic trend of all wavelength measurements stored in the selected period is displayed. The trend shows a visual impression of the measured process values, e.g. during production supervision in the shift operation.
8. Press the **arrow buttons** on the right of the graph to move the dotted cursor line inside of the trend graph to the different measurement values. The absorbance of the selected measurement is displayed on the left vertical axis, while the date/time of this measurement is displayed below the horizontal axis.

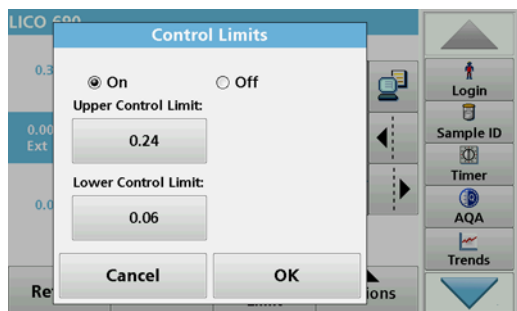

9. Press **Control Limit**.
10. Highlight **On** to change the **Upper Control Limit** and the **Lower Control Limit** settings.

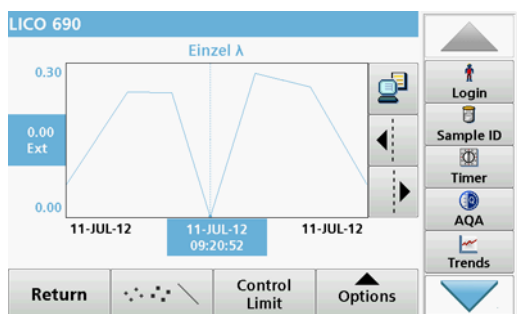

11. The **measured points symbol** changes the display of the measured points.

5.3.3.3 Send single and multi-wavelengths from the measured data memory

Data is sent from the internal data log as an XML (Extensible Markup Language) file or as a CSV (Comma Separated Value) file, to a directory with the name DataLog on a USB mass storage device or a network drive. The file can then be processed using a spreadsheet program. The file name has the format: DL_Instrument Type_Serial Number_Year-Month-Day_Hour_Minute_Second.csv or DL_Instrument Type_Serial Number_Year-Month-Day_Hour_Minute_Second.xml.

To send data to a printer, refer to [section 5.2.6.2, page 34](#).

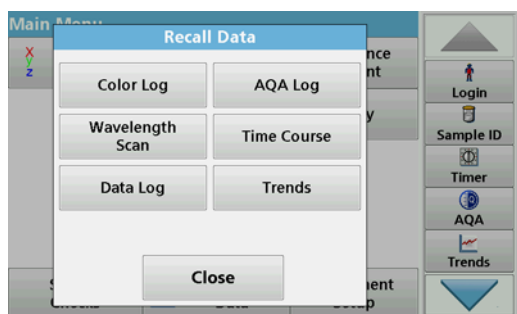

1. Plug the USB memory stick into the USB-A port on the instrument or connect the instrument to a network drive (see [section 5.2.6.4, page 35](#)).
2. In the main menu, press the **Recall Data** menu option.
3. Select the data category to be transferred, e.g. **Data Log**.

A list of the selected measurement data is displayed.

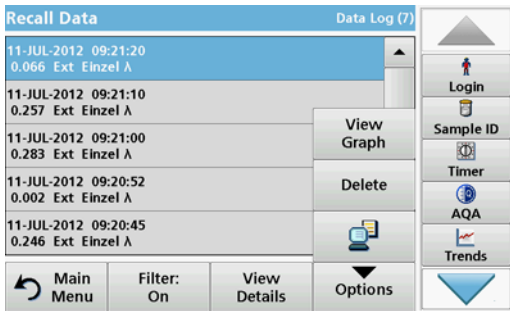

4. Press **Options** and then the **PC & Printer** icon.

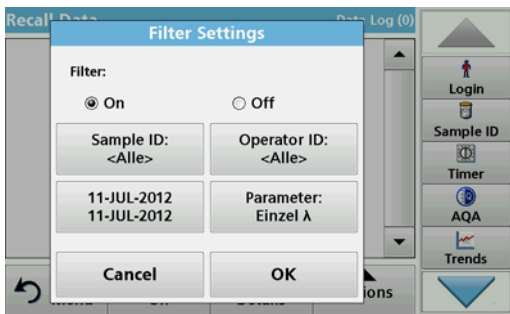

5. Select the data to be sent.
The following options are available:

- **Single point:** only this selected reading will be sent
- **Filtered data:** only readings that correspond to the set filters will be sent
- **All data:** all data in the selected data category will be sent.

6. Press **OK** to confirm.

Note: The number in parentheses is the total number of data sets assigned to this selection.

5.3.3.4 Delete single and multi-wavelengths from the measured data memory

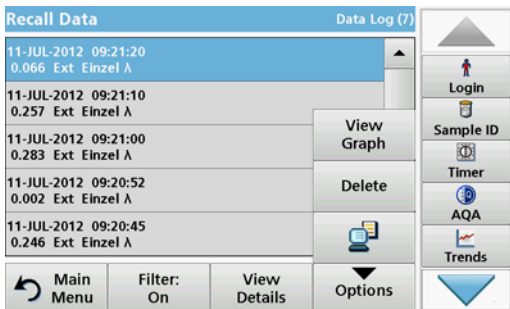

1. In the main menu, press the **Recall Data** menu option.

2. Press **Data Log > Options > Delete**.

3. Highlight **Single point**, **Filtered data** or **All data** and press **OK** to confirm.

Note: The number in parentheses is the total number of data sets assigned to this selection.

5.3.4 Wavelength scan and time course (LCS IV only)

You can save 20 data records for the wavelength scan and 20 data records for the time course. The data must be stored manually after it is displayed.

Standard programs

5.3.4.1 Data storage from wavelength scan or time course

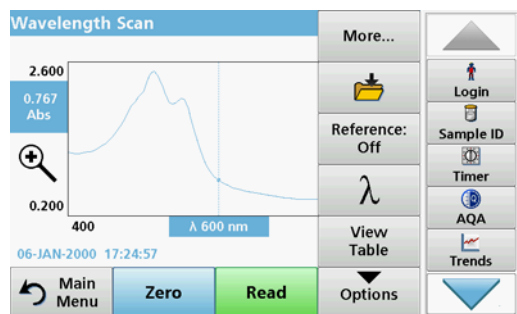

1. Press the **Folder icon** in the "Options" menu after a reading is taken.

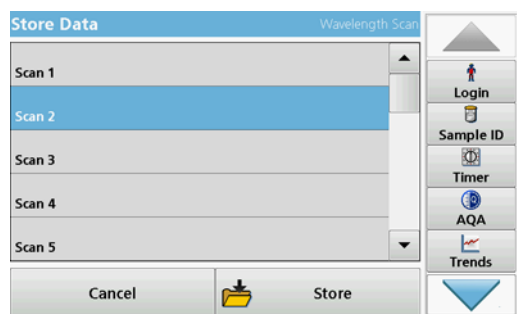

The Store Data list will be displayed.

2. Press **Store** to save the current scan to the highlighted numbered line.

Note: Scans can be overwritten.

5.3.4.2 Recall stored data from wavelength scan or time course



1. In the main menu, press the **Recall Data** menu option.
 - a. Select **Wavelength Scan** or **Time Course** to recall data.
 - b. If you are already working in one of these programs, press **Options > More > Recall Data**.
2. Select the required data.

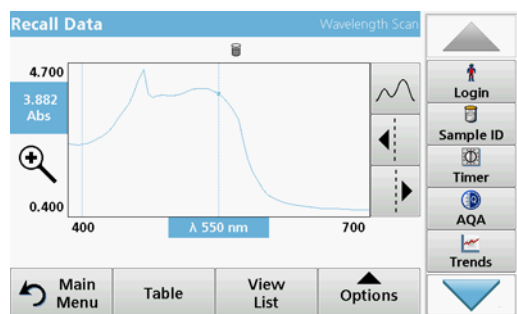

3. Tap on **Graph** to display details.

Note: Press **View List** to return to "Recall Data".

Recall Data			Wavelength Scan		
nm	Abs	Min/Max	nm	Abs	Min/Max
400	2.478		405	2.437	
410	2.428	Valley	415	2.447	
420	2.491		425	2.545	
430	2.615		435	2.695	
440	2.819		445	2.968	
450	3.157		455	3.359	

4. Press **Table** to display details.

*Note: Press **View List** to return to the "Recall Data" list.*

5.3.4.3 Send data from wavelength scan or time course

There are two ways to recall sent data to a USB memory stick, printer or PC with Hach Data Trans.

Recall Data			Wavelength Scan		
nm	Abs	Min/Max	nm	Abs	Min/Max
400	1.200		405	1.185	
410	1.181	Valley	415	1.184	
420	1.192		425	1.204	
430	1.219		435	1.237	
440	1.266		445	1.302	
450	1.349		455	1.400	

Option 1:

1. In the main menu, press the **Recall Data** menu option and then **Wavelength Scan** or **Time Course**.
2. Press **Options** and then the **PC & Printer** icon to send the data to a USB memory stick, to a printer or to a PC with Hach Data Trans.

- When a printer is connected, select how to send the data to the printer (graph, table or both graph and table).
- If a USB memory stick is connected, the files will be automatically sent to the USB memory stick as xml or csv files in the file folder "WLData (data of a wavelength scan) or "TCData" (data of a time course).

The file name has the following format:

- Data from a wavelength scan:
"ScanData_LCS IV_Serial Number_X.xml" or
"ScanData_LCS IV_Serial Number_X.csv"
- Data of a time course:
"TCData_Serial Number_X.xml" or
"TCData_Serial Number_X.csv"

X = number of scans (1–20).

For further processing use a spreadsheet program.

*Note: The message, "Data already present. Overwrite?" is displayed if the files are already stored. Press **OK** to overwrite the stored data.*

Standard programs

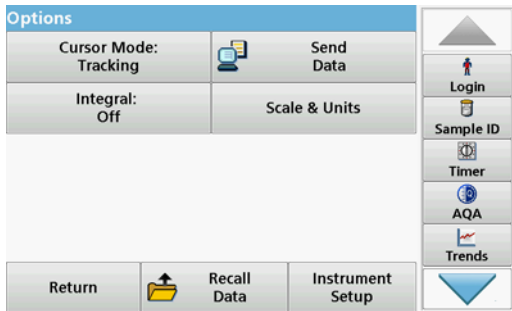

Option 2:

1. Press **Wavelength Scan** or **Time Course** and then **Options > More > Send Data** to send the data to a USB memory stick or to a printer.

- When a printer is connected, select how to send the data to the printer (graph, table or both graph and table).
- If a USB memory stick is connected, the files will be automatically sent to the USB memory stick as xml or csv files in the file folder "WLData (data from a wavelength scan) or "TCData" (data from a time course).

The file name has the following format:

- Data from a wavelength scan:
"ScanData_LCS IV_Serial Number_Year-Month-Day_Hour_Minute_Second.xml" or
"ScanData_LCS IV_Serial Number_Year-Month-Day_Hour_Minute_Second.csv"
- Data from a time course:
"TCData_LCS IV_Serial Number_Year-Month-Day_Hour_Minute_Second.xml" or
"TCData_LCS IV_Serial Number_Year-Month-Day_Hour_Minute_Second.csv"

For further processing use a spreadsheet program.

5.3.4.4 Delete stored data from wavelength scan or time course

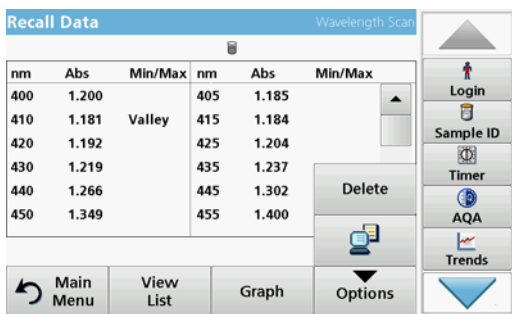

1. In the main menu, press the **Recall Data** menu option and then **Wavelength Scan** or **Time Course**.

A listing of the stored data is displayed.

2. Highlight any data to delete.
3. Press **Delete** in the "Options" menu and press **OK** to confirm.

5.3.5 Trends

You can use the **Trends** function to recall a load curve of the saved measured values for each color value and sample location. The concentration of the corresponding parameter is shown graphically over time.

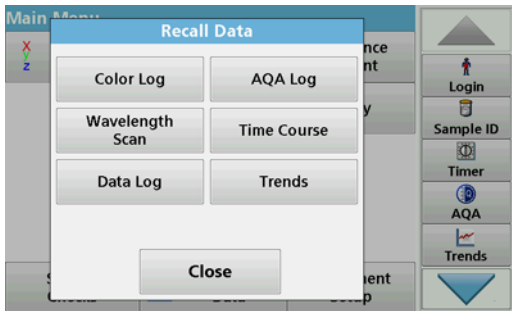

1. Press **Recall Data > Trends**.

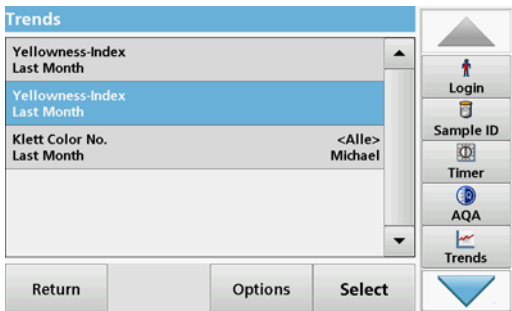

2. A list of all trend analyses is displayed.

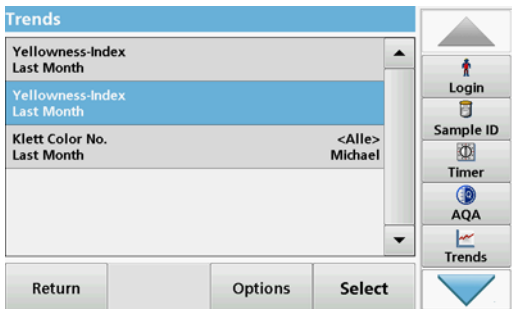

3. Press **Options** and **New** to create a new trend.

Edit enables you to change the settings for an existing trend, **Delete** enables you to delete an existing trend.

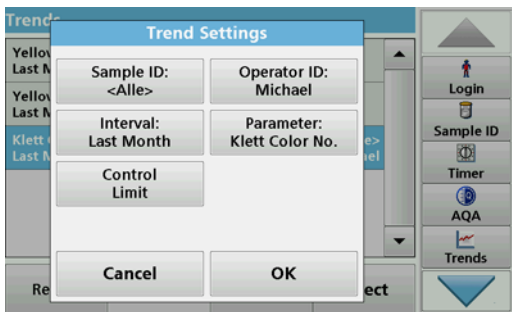

4. Define the trend settings according to sample ID, operator ID, time interval and parameter.

Standard programs

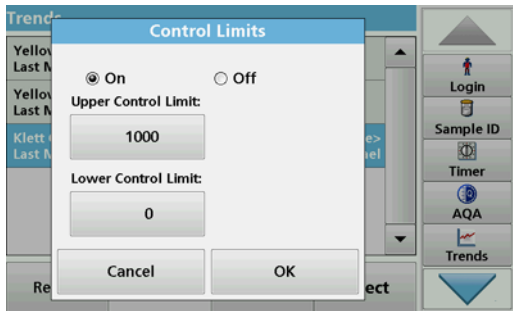

5. Use control limits to define the upper and lower limits that are displayed in the graphic.

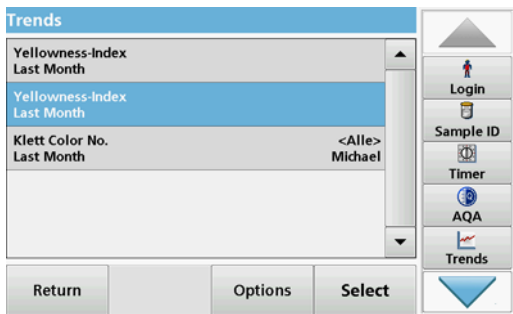

6. Select the required trend and confirm with **Select**.

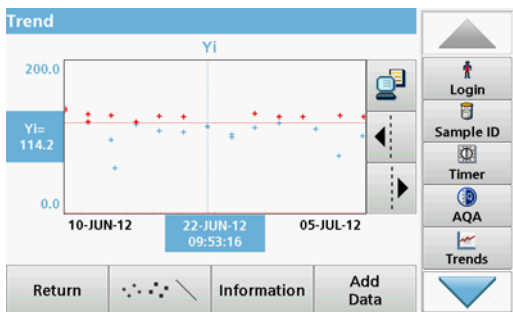

7. The trend can be displayed in several formats, as a line or as points.

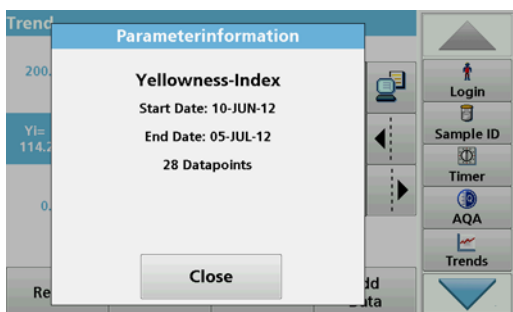

8. Press **Information** to recall an overview of the parameter information.

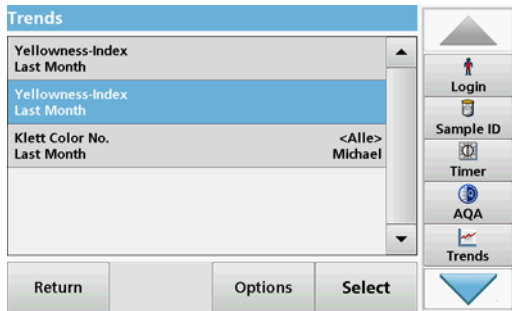

9. Press **Add Data** to include additional measured values in the trend.

5.4 Take and prepare samples

Take a representative sample from the product you wish to measure in accordance with DIN EN ISO 15528 (or ASTM D3925-02).

If the material shows any signs of turbidity, remove this turbidity by filtration, centrifuging, heating, ultrasound treatment or other suitable means.

Heat partly solid samples before measuring in order to dissolve the solid material in the liquid. The preparation must not cause any chemical changes in the sample.

Make sure that during the measurement there are no bubbles in the sample.

For the color difference measurement, three cuvette types are available that differ in terms of material (glass, PS and PMMA) and path length (10 mm, 11 mm and 50 mm). Add approx. 2 cm of the sample to the cuvette. The light beam passes through the cuvette approx. 0.5 cm to 1.5 cm above the bottom of the cuvette.

The program calculates the iodine, Hazen, Gardner, Saybolt, Klett and ASTM D 1500 color values automatically and displays the color values. The cuvette type being used is taken into consideration.

A dry thermostat is available for the round disposable glass cuvettes with 11 mm. The dry thermostat heats up the cuvette to any temperature between ambient temperature and 150 °C (302 °F).

NOTICE

The samples must be clear and free of turbidity. If products in paste or solid form cannot be measured directly, the product must be melted before being transferred to the cuvettes/sample cells. Make sure the cuvettes/sample cells do not contain any air bubbles.

- Always hold the cuvette/sample cell close to the top to make sure that there are no fingerprints in the measurement zone of the cuvette/sample cell. Use suitable transfer pipettes to introduce samples into the cuvettes/sample cells.
- Slowly add samples to the cuvettes/sample cells to make sure air bubbles do not form on the cuvette/sample cell wall and in the sample. Air bubbles will cause false readings.

- If air bubbles are entrapped, remove them by heat, vacuum, ultrasonic treatment or other suitable means.
- Clean the outside of the cuvettes/sample cells thoroughly before inserting them in the cell compartment.

NOTICE

Before using disposable cuvettes/sample cells made of PS (Polystyrene) or PMMA (Polymethyl methacrylate), be sure that the cuvettes/sample cells will not be destroyed by samples, otherwise the cell compartment can be damaged.

5.5 Color measurement

Proper sample preparation is extremely important for accurate color measurement. To make sure that an exact measurement is taken, refer to the following sample preparation guidelines:

- Always clean the glass cuvettes/sample cells immediately after use.
- Only use optically preferred samples for measurement. Make sure the cuvettes/sample cells are clean and show no signs of opaqueness.
- Slowly add the liquid to the cuvette in order to prevent the formation of air bubbles in the sample.
- Chapter 5.4, Page 53 contains further information on preparing and taking samples.

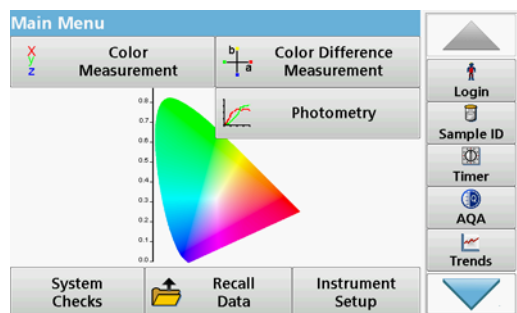

The color measurement mode is used to determine absolute color values in the Hazen, Gardner, CIE L*a*b* or European Pharmacopoeia color scales.

For each cuvette type (11 mm round cuvette and 10 and 50 mm square cuvettes), an independent calibration data record is used.

It is possible to calibrate the instrument with one, two or three types of cuvettes/sample cells and to use these different cuvette/sample cell types in parallel.

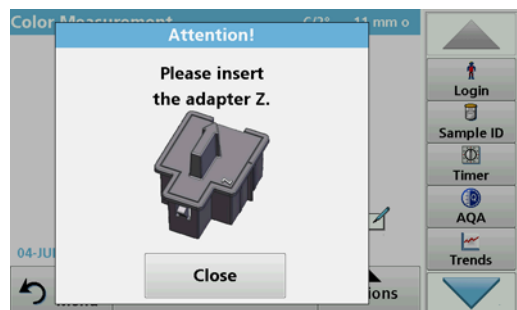

To use the 10 mm square cuvette and 11 mm round cuvettes, adapter Z must be inserted into the cuvette compartment (2). For measurements with 50 mm square cuvettes, you must remove the adapter.

5.5.1 Take a color measurement



1. Press **Color Measurement**.
2. Insert a cuvette/sample cell with distilled water to calibrate.

Note: Always carry out the calibration very carefully, as a faulty calibration can cause inaccurate results to be obtained.

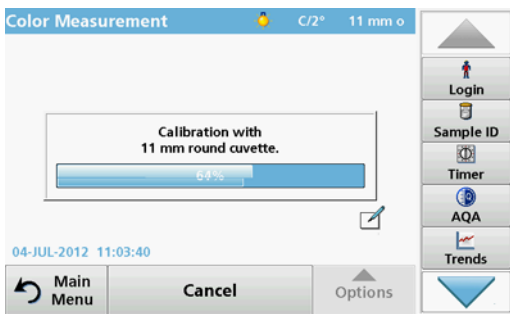

3. The calibration starts automatically once the instrument has detected the cuvette.

The type of cuvette/sample cell used and the exact progress of calibration is shown in a separate window.



4. After calibration, the cuvette size used is displayed in the top right.

Note: After calibration, you can measure the cuvette with distilled water again as a sample. The displayed measured values should match the uncolored color indices (i.e. Hazen = 0, Gardner = 0.0, CIE L*a*b* = 100.0, 0.0, 0.0, etc.)

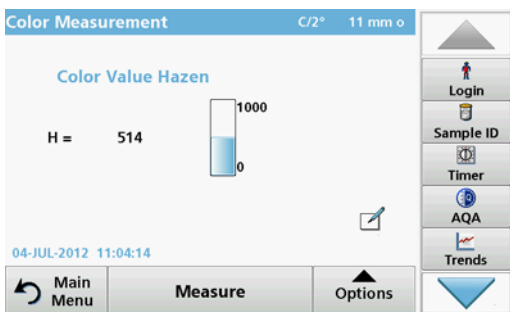

5. Insert the test cuvette.

The measurement starts automatically. The result of the color calculation is displayed.

Note: The bar on the right next to the result shows the result relative to the measurement range.

6. For the next measurement, remove the cuvette and insert the next sample cuvette, or press Measure to measure the same sample again.

5.5.1.1 Touch-sensitive areas in measurement mode

In measurement mode, there are touch-sensitive areas that give you immediate access to various menu options.

Standard programs

Figure 4 Touch-sensitive areas in measurement mode

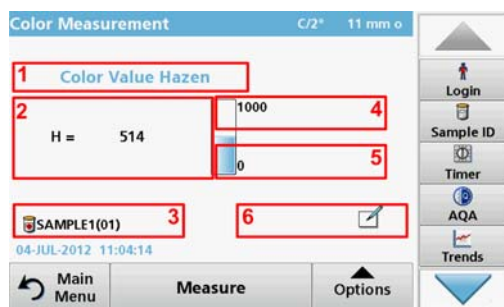

1	Open Select Color Scale , and select the scale for the display (see section 5.5.1.3, page 57).	4	Change the Upper Limit of the color range (see section 5.5.1.4, page 58).
2	Change the displayed color scale to the next color system which is selected in the Operator ID color scale list for display (see section 5.5.1.3, page 57).	5	Change the Lower Limit of the color range (see section 5.5.1.4, page 58).
3	Open Sample ID to change or add the sample ID (see section 5.2.2, page 24).	6	Open Comments to enter a comment.

5.5.1.2 Parameter setup options

Press **Options** to set up the parameter.

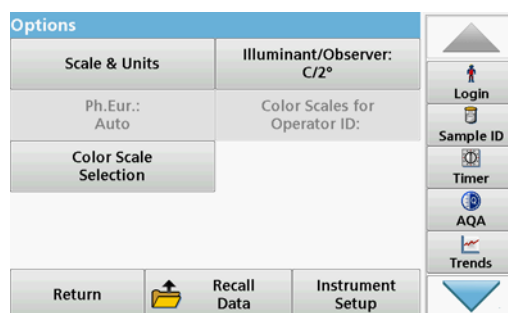
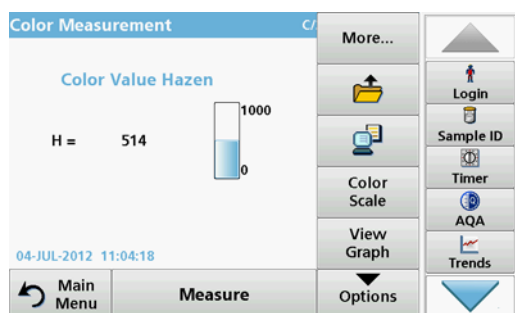

Table 4 Color measurement options

Options	Description
More	For further Options
Save icon	Symbol: Store Data , if Instrument Setup > Data Log Setup > Auto Store: Off is selected. Symbol: Recall Data , if Instrument Setup > Data Log Setup > Auto Store: On is selected.
Send Data icon	To send data to a printer, computer or USB memory stick (USB A) or network.
Color Scale	Select the color scale
View Graph View Table View Values	VIEW GRAPH shows the spectral graph of the transmittance or absorbance graph. Note: View Graph is activated after the first measured value. VIEW TABLE displays the spectral transmittance values T% from 380 nm to 720 nm. VIEW VALUES displays the result of the last color calculation.
Scale & Units	UNITS: Select absorbance or transmittance. SCALE: In the automatic Scale mode, the y-axis is automatically adjusted so that the total scan is displayed. The manual Scale mode allows sections of the scan to be displayed.
Ph.Eur.: Auto	European Pharmacopoeia Select AUTO or the REQUIRED SCALE

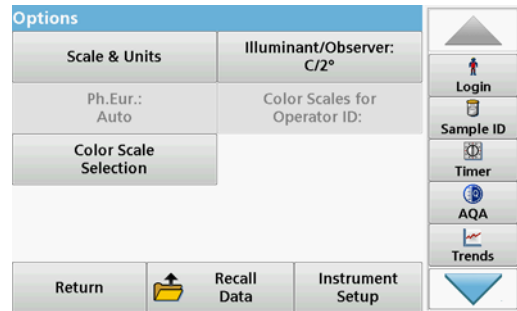
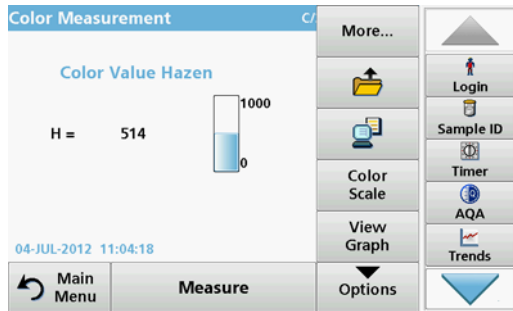
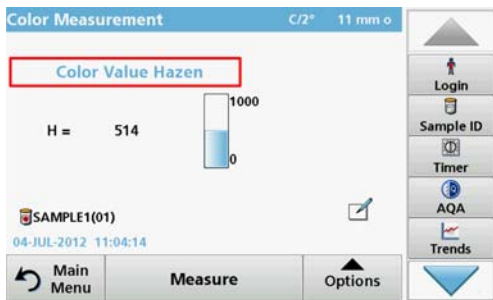

Table 4 Color measurement options(Continued)

Options	Description
Color Scale Selection	Define 3 different color scale combinations with up to 3 different color scales for the result display. Selection 1: Klett Color No. + Yellowness Index Selection 2: Klett Color No. + ADMI Color No. + Yellowness Index Selection 3: Yellowness Index + individual transmittance
Illuminant/Observer: C/2°	Illuminant: Select C, A or D65 Observer: 2° or 10°
Color Scales for Operator ID:	Individual selection of the color scales for the operator ID.

5.5.1.3 Change the color scale after a measurement



1. Press the touch-sensitive area, e. g. **Color Value Gardner**.

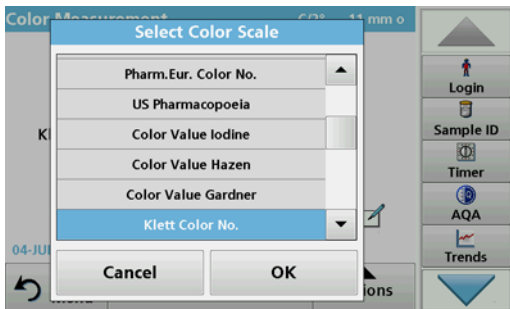

2. A list of all color scales is displayed.

3. Select the required scale.

4. Press **OK** to confirm.

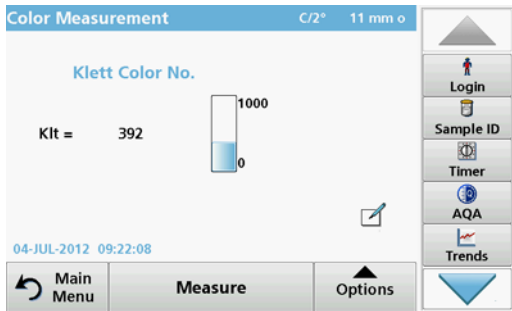

The current result of the actual reading and all further measurements will be displayed in the selected color scale.

Alternative

1. Tap the touch-sensitive area **Result**.
2. The result is shown in the next color scale in the list.

5.5.1.4 Change the measuring range after a measurement



1. Tap the touch-sensitive areas for the upper or lower limits of the barchart.
2. Enter the new limit and press **OK** to confirm.

Note: The changed measurement range limit is displayed in blue.

Note: It is only possible to change the limits inside the measuring range of the color scale. It is not possible to expand the range, e. g. to Hazen 2000.

The current result and all further measurements will be displayed with the new measuring range.

5.5.2 Determination of the iodine color value

DIN 6162 defines the iodine color value as mg iodine per 100 mL potassium iodide solution. Color matching with the iodine color scale determines the depth of color of clear liquids like solvents, plasticisers, resins, oils and fatty acids, whose color is similar to that of a solution of iodine and potassium iodide of the same thickness.

For iodine color values of less than or approximately 1, the determination of the Hazen value according to DIN-ISO 6271 is to be preferred. Taking and preparing samples is described in Chapter 5.4, Page 53. The iodine color value can be determined with sufficient accuracy using an 11 mm disposable glass round cuvette.

5.5.3 Determination of the Hazen color value (Pt-Co or APHA method)

The Hazen color value (ISO 6271, also referred to as the "APHA method" or Platinum-Cobalt Scale) is defined as mg platinum per 1 liter of solution. The Hazen parent solution comprises 1.246 g potassium-hexachloroplatinate (IV) and 1.00 g cobalt(II) chloride, which is dissolved in 100 mL hydrochloric acid and topped up to 1000 mL with distilled water.

The Hazen-color scale is used to evaluate the colors of nearly water-clear products. It has narrower gradations in the light yellow range than the Iodine Color Scale and extends to water-clear color casts.

Note: Samples with Hazen values of between 50 and 1000 can be measured with sufficient accuracy in 10 mm square and 11 mm round

cuvettes. Hazen values below 50 should be measured in 50 mm cuvettes. Hazen values below 10 should be measured only with the 50 mm cuvette that was used for the calibration. The reason for this is that almost colorless products can cause false measurement results due to the cuvette tolerances.

5.5.4 Determination of the Gardner color value

The Gardner color value is defined in DIN-ISO 4630. The Gardner color values for lighter color tones (1 to 8) are based on potassium-chloroplatinate solutions, while the color values for darker color tones (9 to 18) are based on solutions of iron(III) chloride, cobalt(II) chloride and hydrochloric acid. You can determine Gardner values with all cuvette path lengths (but only values up to Gardner color value 4 in 50 mm cuvettes).

The 10 mm and 11 mm cuvettes, however, usually offer adequate accuracy.

5.5.5 Determination of the Mineral oil color value (ASTM D 1500 and ISO 2049)

The mineral oil color scale is used to evaluate the color of mineral oil products such as lubricating oils, fuel oil, diesel fuel and paraffin. The color scale starts at color value 0 for water-white, non-colored oils and ends at 8 for very dark brown oils. The substances are optically rated in multiples of 0.5 (0.5; 1.0; 1.5 etc.). The instrument displays the results in multiples of 0.1. For samples whose color value is higher than 8, *** is displayed.

Note: Due to the strong color of the ASTM D 1500 color number, it is only calculated for 11 mm round or 10 mm square cuvettes. No calculation is carried out for the 50 mm path length.

5.5.6 Determination of the Saybolt color number (ASTM D 156)

The Saybolt color scale is used to evaluate refined oil products such as petrol and kerosene, as well as petroleum waxes and pharmaceutical white oils.

The Saybolt color properties are comparable to those of the Hazen scale (APHA). The Saybolt color scale starts at color value +30 (lightest color, corresponds to approx. 8 to 10 Hazen) and ends at -16 (strongest color, corresponds to approx. 350 Hazen).

The measurements can be taken in cuvettes with path lengths of 10 mm, 11 mm or 50 mm. A longer path length increases the measurement accuracy (50 mm recommended).

5.5.7 Color determinations only by LCS IV

5.5.7.1 Color determination according to the European Pharmacopoeia (EP)



The method used to determine coloration according to the European Pharmacopoeia (Pharm.Eur.) corresponds to the specifications in *Chapter 2.2.2 of the Pharmacopoeia "Degree of Coloration of Liquids"*, in which a total of 37 color reference solutions for the color tones yellow (Y1 – Y7), green-yellow (GY1 – GY7), brownish-yellow (BY1 – BY7), brownish (B1-B9) and red (R1-R7) are defined. Each color reference solution is clearly defined in the CIE L*a*b* color space in terms of brightness, hue and saturation.

There are two ways of color matching of a sample with the Ph.Eur.system.system:

- **Automatic:** The color of the solution is compared to the colors of the 37 color reference solutions. The identifier of the reference solution whose color is closest to that of the sample (i.e. the reference solution with the smallest color difference ΔE^* to the sample) is displayed.
- **Specified scale:** A scale is specified (e.g. BY). The identifier of the reference solution whose color is closest to that of the sample (i.e. the reference solution with the smallest color difference ΔE^* to the sample within the specified scale) is displayed.

If a scale is defined (e.g. scale BY), one of the following five symbols is used to define the relationship between the measured results and the scale (see Table 5).

Table 5 Specified scale

Character	Description
= equal	The color number of the sample is equal to that of the reference solution
< less	The color number of the sample is less than that of the reference solution
> greater	The color number of the sample is greater than that of the reference solution
<> between	The color number of the sample is between those of two reference solutions
-> next	The color number of the sample does not match any reference solution in this scale, but the indicated reference solution is nearest in color

The ΔL^* , Δa^* and Δb^* values are the numerical differences between the L^* , a^* and b^* values of the samples and the displayed Pharmacopeia color reference solution. The measurements can be taken using cuvettes with 10 mm, 11 mm or 50 mm path lengths. The CIE $L^*a^*b^*$ values depend on the path length and are always related to the type of cuvette/sample cell employed. The longer the path length, the better the measuring accuracy.

1. Insert the test cuvette.

The result of the color calculation is displayed.

2. Press the **Auto B 4** touch-sensitive area.



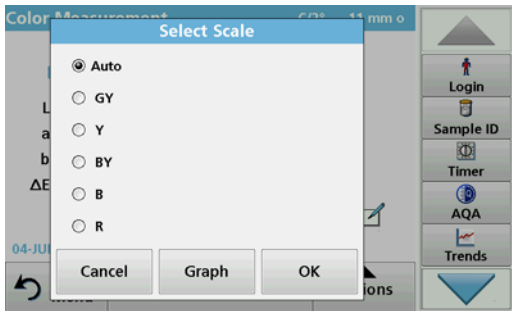

3. Press **Auto**.

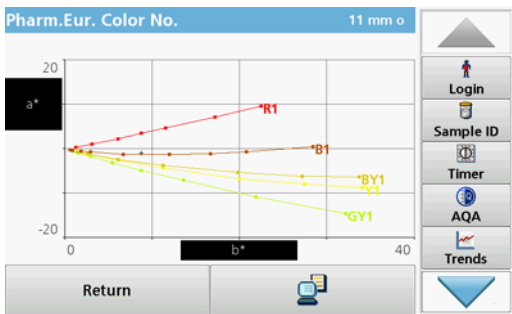

4. Press **Graph**.

The color matching result is now displayed graphically.

The upper value shows the option used for the color matching calculation which can be **Auto** for matching in all 5 Pharm.Eur.Scales or **B**, **BY**, **Y**, **GY** or **R** for matching only inside of the selected color scale.

The lower entry shows the color matching result, e. g. brown 4 (B4) in this example.

The ΔLab^* value shows the color difference of the measured sample relative to the stated reference solution B4.

The ΔE^* value shows the three-dimensional color difference of the measured sample relative to the stated reference solution B4.

5. Press **Return** to change the option for the color matching function.

6. **Select Scale** is displayed.

7. The option for color matching to a special scale can be changed.

8. **Graph** offers a visualisation of the matching result in the selected matching option.

9. Depending on the scale selection, the appropriate graph of the color scale will be displayed.

When option **Auto** is selected the a^* , b^* color locus of the measured sample will be displayed in all 5 color scales of the Pharm Eur.

10. Press the **Print** symbol to print the graph.

Standard programs



The CIE $L^*a^*b^*$ values depend on the path length of the cuvette/sample cell. Therefore the scale of the a^* , b^* axis in the graph depends also on the cuvette/sample cell size.

Graph for the greenish yellow scale GY.



Graph for the brownish scale B.

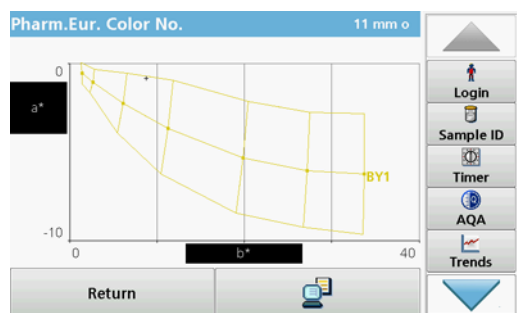

Graph for the brownish yellow scale BY.



Graph for the yellow scale Y.

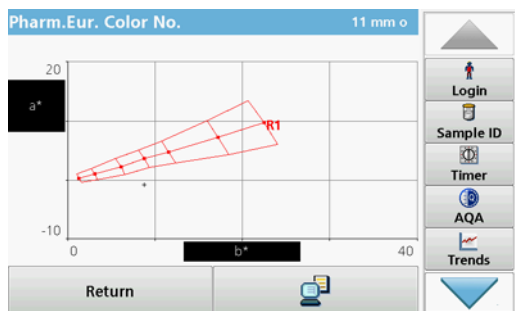

Graph for the red scale R.

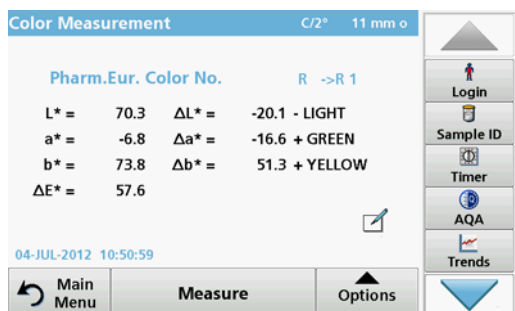

If the CIE $L^*a^*b^*$ value of the sample does not correspond to any reference solution in a selected scale, the \gt (next) symbol appears, followed by the next reference solution with the smallest color difference ΔE^* . In this case, select **Auto** for a color matching in all scales to see which color scale and color reference solution is the closest to the sample color.

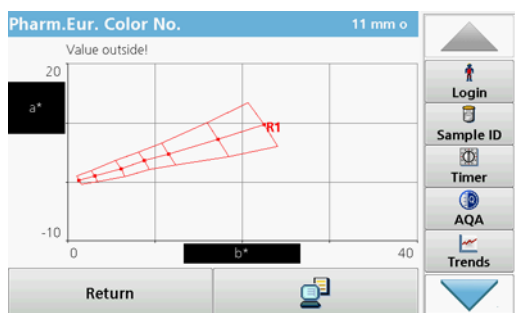

If the color space of the sample is outside the graph of a color comparison scale, the error message **Value outside!** appears above the graph.

5.5.7.2 Color determination according to the US Pharmacopoeia (USP)

The method used to determine color according to the US Pharmacopoeia corresponds to the specifications in *Chapter 631 "Color and Achromicity"* and in *Chapter 1061 "Color - Instrumental measurement"*. A total of 20 color reference solutions (identified by the sequential letters A to T) are defined in the US Pharmacopoeia. The color of the measured sample is automatically correlated to the color reference solutions. This means that the color reference solution that is closest to the sample (i.e. the reference solution with the smallest color difference ΔE^* to the color of the sample) is displayed. The values ΔL^* , Δa^* and Δb^* are the quantitative differences between the L^* , a^* and b^* values of the sample and those of the displayed USP solutions.

The measurements can be taken using cuvettes with path lengths of 10 mm, 11 mm or 50 mm. The use of longer path lengths increases the accuracy of the measurement.

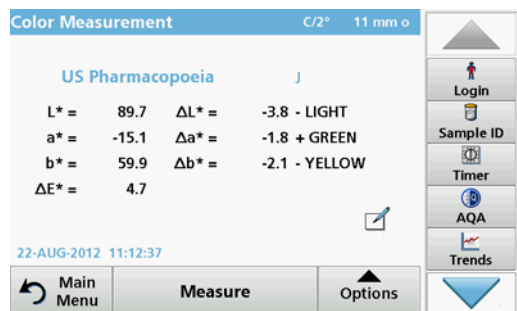

The CIE $L^*a^*b^*$ values depend on the path length and are always related to the type of cuvette/sample cell used.

1. Press **US Pharmacopoeia**.
2. Insert the test cuvette.
3. The result of the color calculation is displayed.

The $\Delta L^*a^*b^*$ value shows the color difference of the measured sample relative to the next USP color standard, which is displayed above the color difference values (in this case color standard B).

The ΔE^* value shows the three-dimensional color difference of the measured sample relative to the USP color standard B.



The touch-sensitive area around the color standard is active.

4. Press the area around the color standard (in this case B). The color axis a^* , b^* and the loci of the sample (+) is displayed as well as the USP color standards. The color matching result is displayed graphically.
5. Press the **Send Data** symbol to print the graphic or **Return** to exit the window.

5.5.7.3 Color determination according to the Chinese Pharmacopoeia (CP)

The Chinese grade scheme for pharmaceutical solutions is split into five color scales: yellow-green (YG1 - YG10); yellow (Y1 - Y10); orange-yellow (OY1 - OY10); orange-red (OR1 - OR10); brown-red (BR1 - BR10). The Chinese Pharmacopoeia resembles the color scales of the European Pharmacopoeia (EP), with yellow, red and blue primary solutions. The yellow solutions, however, differ from the European Pharmacopoeia in the proportion of solution and color designation.

5.5.7.4 Determination of the Klett color value

The Klett color number is used in the cosmetics industry to evaluate surfactants and detergents. The Klett color value is usually measured in 40 mm cuvettes/sample cells with a Summerson photometer using a blue filter (no. 42).

The measuring range starts at Klett color number 0 and ends at Klett color number 1000.

You can measure the Klett color value with all cuvette types (10, 11 and 50 mm). The 50 mm cuvette, however, offers the highest accuracy. For Klett, however, the measurement result is always calculated with 40 mm and blue filter no. 42.

5.5.7.5 Determination of the AOCS Cc 13 e (Lovibond®) scale

The calculation of the Lovibond color values is derived from the methods AOCS Cc 13e or BS 684 -1.14 and based on the yellow/red values (5 1/2 inch or 1 inch) of the AF900/AF960 instruments. On the printout, the 1" values are identified by a 1.

5.5.7.6 Determination of the Yellowness Index (ASTM D 1925)

The Yellowness Index is calculated and displayed according to ASTM D 1925 for standard illuminant C and a 2° standard observer. This color value can be measured in 10 mm, 11 mm or 50 mm cuvettes.

The Yellowness Index is calculated as follows:

$$Y_i = 100 \times (1.277 \times X + 1.059 \times Z) / Y$$

5.5.7.7 Determination of the Hess-Ives color number

The Hess-Ives color number is used in the cosmetics industry to evaluate the color of fat derivatives. It combines in one number the weighted color intensities, which represent the red, green and blue parts of the transmittance spectrum of the sample at 3 wavelengths. It is defined in DGK 8 method no. F 050.2 and calculated and displayed in accordance with this method. The Hess-Ives color number is calculated from:

$$H - I = ((R + G + B) \times 6) / \text{path length}$$

R, G and B are the color components for the red (640 nm), green (560 nm) and blue (464 nm) parts. For R, G and B:

$$R = 43.45 \times E_{640}$$

$$G = 162.38 \times E_{560}$$

$$B = 22.89 \times (E_{460} + E_{470}) / 2$$

5.5.7.8 Determination of the ADMI color number

The ADMI color number is used to measure the color of water and wastewater having color characteristics significantly different from platinum-cobalt standards, as well as to those similar in hue to the standards.

The American Dye Manufacturers Institute (ADMI) has adopted the Platinum-Cobalt standard of the American Public Health Association (APHA) as the standard for color value. Although this standard is yellow, the ADMI method works for all hues.

The measurements can be taken using 10 mm, 11 mm or 50 mm cuvettes. A longer path length increases the measurement accuracy (50 mm path length is recommended).

Turbid samples must be filtered prior to analysis.

5.5.7.9 Determination of the Acid wash color

ASTM D848 - 09 is the standard test method for the acid wash color in the "aromatic hydrocarbon" industry. The test procedure covers the determination of the acid wash color for benzene, toluene, xylene, refined solvents such as naphtha and similar aromatic hydrocarbons. The color scale was developed for detecting impurities in industrial aromatic hydrocarbons. Sulfur contamination causes the material to discolor, for example.

5.5.7.10 Determination of the ICUMSA color index

The ICUMSA (International Commission for Uniform Methods of Sugar Analysis) color index is a photometric method for color correction of filtered sugar solutions. The test method is based on the transmittance of the solution with a known concentration (Brix value) at a wavelength of 420 nm.

5.6 Measurement of color differences (LCS IV only)

The mode for color difference measurement is used to determine a quantitative color difference between a reference (R) and a sample (P) in the three-dimensional color space (CIE L*a*b* or Hunter Lab). In this mode, an additional reference memory for up to 100 references is available.

5.6.1 Take a color difference measurement



1. In the Main Menu, press **Color Difference Measurement**.
2. Insert a reference cuvette/cell.

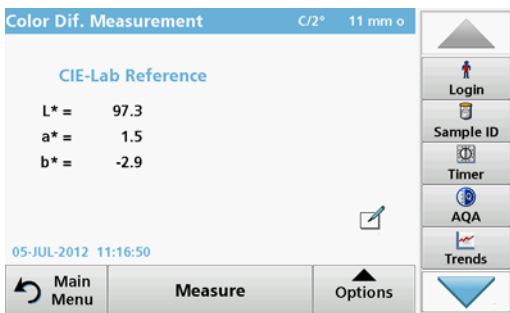

3. The CIE L*a*b* reference value of the sample is displayed.
4. Remove the reference cuvette/cell.

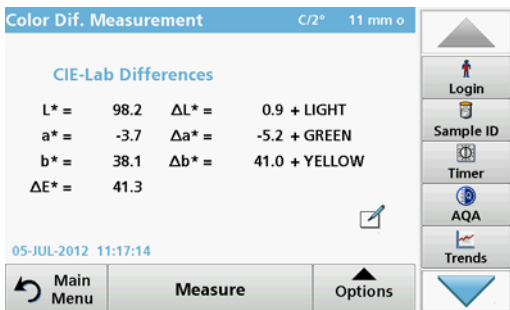

5. Insert the sample cuvette/cell or press **Measure** to measure the reference cuvette/cell once again.
6. The color values of the sample and the color differences between the sample and the reference are displayed.

7. Press **Option** for Parameter Setup. [Table 6](#) contains additional information on the program options.

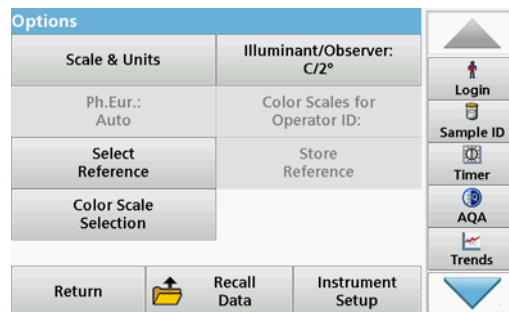
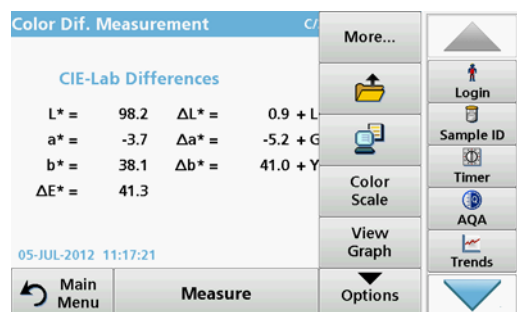
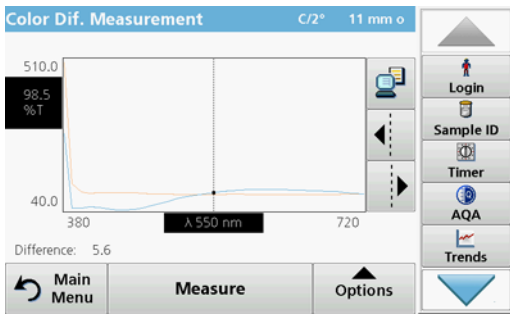

Table 6 Options for color difference measurement

Options	Description
More	For further Options
Save icon	Symbol: Store Data , if Instrument Setup > Data Log Setup > Auto Store: Off is selected. Symbol: Recall Data , if Instrument Setup > Data Log Setup > Auto Store: On is selected.
Send Data icon	To send data to a printer, computer or USB memory stick (Type A)
Color Scale	Select the color scale
View Graph View Table View Values	VIEW GRAPH shows the spectral graph of the transmission or absorbance curve. "View Graph" will be activated after the first reading. VIEW TABLE displays the spectral transmittance values T% from 380 nm to 720 nm. VIEW VALUES shows the result of the last color calculation.
Scale & Units	UNITS: Select absorbance or transmittance. SCALE: In the automatic Scale mode, the y-axis is automatically adjusted so that the total scan is displayed. The manual Scale mode allows sections of the scan to be displayed.
Ph.Eur.: Auto	European Pharmacopoeia Select AUTO or REQUIRED SCALE
Select Reference	Select stored reference data.
Color Scale selection	Define 3 different color scale combinations with up to 3 different color scales for the result display. Selection 1: Klett color number + Yellowness Index Selection 2: Klett color number + ADMI color number + Yellowness Index Selection 3: Yellowness Index + individual transmittance
Illuminant/observer	Illuminant: Select C, A or D65 Observer : 2° or 10°
Color Scales for Operator ID	Configure the color scale to display or to print
Store Reference	Store new reference data.

5.6.1.1 View graph/table/values



1. Press **Options > View Graph** to display the transmittance graph for the sample (black line) and the reference (red line) in the wavelength range of 380 nm to 720 nm on the x-axis and the % transmittance on the y-axis. In the middle of the graph a dotted cursor line is displayed. Below the graphic, the transmission difference between reference and sample on the current cursor position is displayed.

2. Press the appropriate button on the right screen to move the cursor line left or right or touch any position inside of the graph area. In the middle of the x-axis the wavelength at the actual cursor position is displayed.

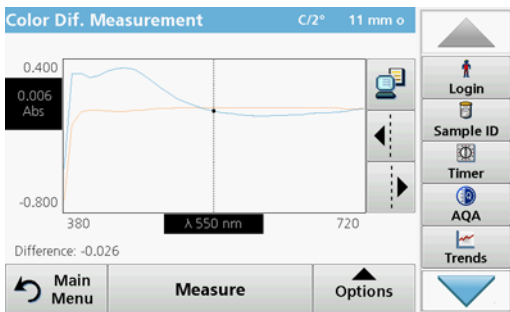

3. Press **Options > More > Scale & Units > Ext.** A graph showing the absorbance curve for the measurement is displayed. Below the graph diagram, the absorption difference is displayed.

nm	%T	nm	%T	nm	%T
380	281.2	390	49.6	400	49.6
410	53.6	420	51.3	430	47.4
440	45.1	450	44.7	460	46.3
470	50.0	480	56.8	490	63.8
500	71.5	510	79.0	520	84.4
530	89.9	540	94.6	550	98.5
560	102.0	570	103.9	580	105.7

4. Press **Options > View Table** to switch to the table of transmittance values or absorbance values (depending on the option selected in "Scale & Units").

There are three columns in which the wavelengths 380 nm to 580 nm and the corresponding transmittance/absorbance are displayed.

Scroll down to display the transmittance and absorbance wavelengths up to 720 nm.

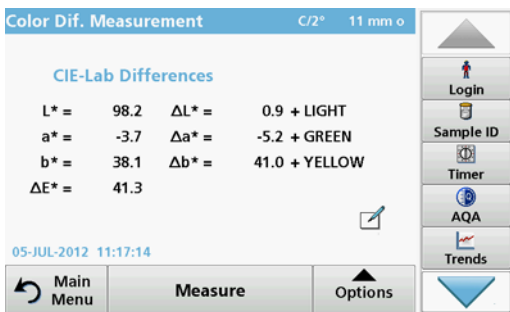

5. Press **Options > View Values.** The color value of the sample is displayed.

Standard programs

5.6.2 Take a color difference measurement with stored reference values



1. Press **Color Difference Measurement** from the Main Menu.
2. Press **Select Reference**.

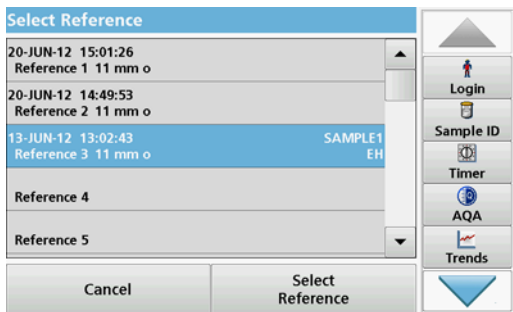

3. A list of available references is displayed.
4. Press the required reference.
5. Press **Select Reference** to confirm.
6. Insert the test cuvette.

Important note: For the color difference measurement, it is absolutely necessary that the type of cuvette/sample cell used for the sample measurement is identical to the type of cuvette/sample cell that was used for the reference measurement.

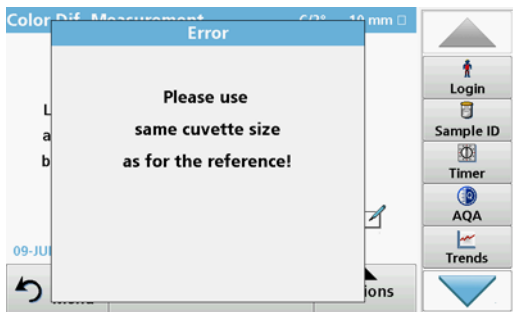

Example:

It is not possible to select a reference that was measured in a 10 mm cuvette, and then run a difference measurement with a 50 mm cuvette.

5.6.3 Add a reference to the reference list

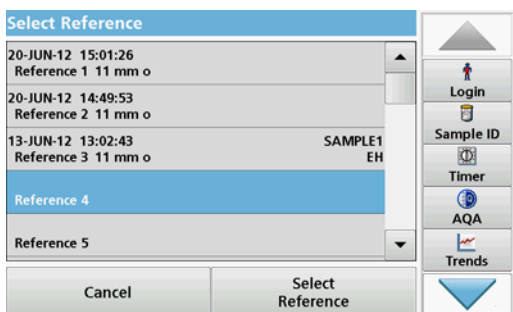

1. Press **Color Difference Measurement** from the Main Menu.
2. Insert a reference cuvette/cell.
3. Press **Options >More > Store Reference**. The Reference Data list is displayed.
4. Press a free reference number.
5. Press **Store**.

5.7 Photometry (LCS IV only)

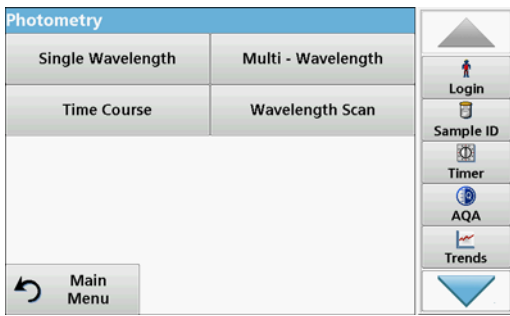

In the photometry mode, photometric measurements can be carried out as:

- Single wavelength measurements
- Multi wavelength measurements
- Time course
- Wavelength scans

5.7.1 Single Wavelength (absorbance, concentration and transmittance readings)

The Single Wavelength mode can be used in three ways. For sample readings at a single wavelength, the instrument can be programmed to measure the absorbance, % transmittance or concentration of the analyte.

- Absorbance readings: The light absorbed by the sample is measured in absorbance units.
- % Transmittance measures the percent of the original light that passes through the sample and reaches the detector.
- Turning on the concentration factor allows selection of a specific multiplier for converting absorbance readings to concentration. In a graph of concentration versus the absorbance, the concentration factor is the slope of the line.

5.7.1.1 Set up Single Wavelength mode

1. In the main menu, press the **Single Wavelength** menu option.
2. Press **Options** for Parameter Setup.

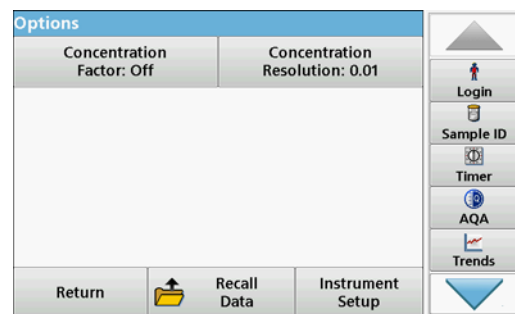
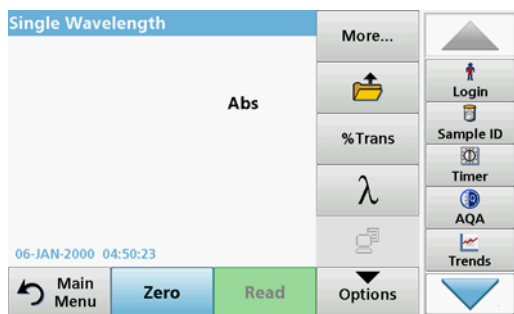

Table 7 Options for Single Wavelength

Options	Description
More	For further Options
Save icon	Symbol: Store Data , if Instrument Setup > Data Log Setup > Auto Store: Off is selected. Symbol: Recall Data , if Instrument Setup > Data Log Setup > Auto Store: On is selected.
% Trans/Abs	To switch to % transmittance, concentration or absorbance readings

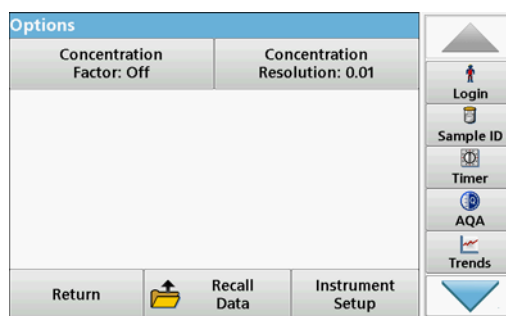
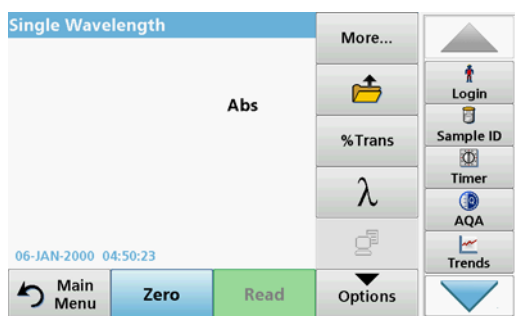
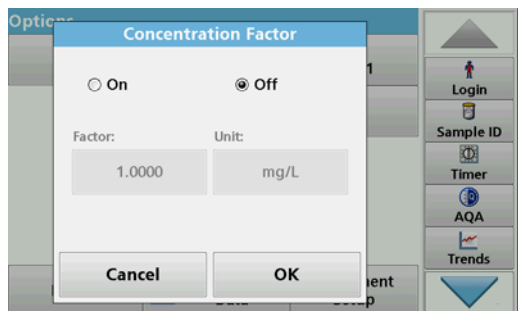

Table 7 Options for Single Wavelength(Continued)

Options	Description
λWavelength	To input the wavelength setting. Use the alphanumeric keypad to enter the reading wavelengths. The entered wavelength must be in the range from 320-110 nm.
Send Data icon	To send data to a printer, computer or USB memory stick (Type A)
Concentration Factor	Multiplication factor for converting absorbance values into concentration values.
Concentration Resolution	To select the number of decimal places.
Recall measurement data	Recall saved measurement data, wavelength scans or time courses, refer to section 5.3, page 38 .
Instrument Setup mode	Basic data of the instrument, refer to section 5.2, page 23 .



Concentration Factor:

1. Press **Concentration Factor: Off** in the "Options" menu.
2. Press **On** to activate this function.
3. Press the Factor button and enter the factor.
4. Press **Unit** and select the corresponding units for concentration from the displayed list.
5. Press **OK** to confirm.

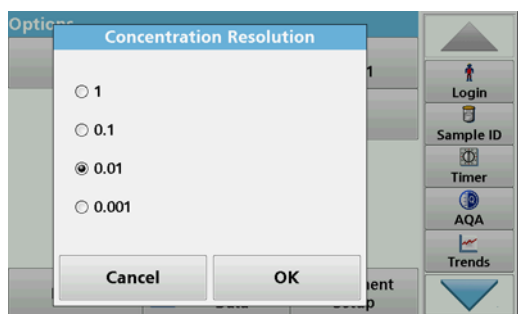

Concentration Resolution:

1. Press **Concentration Resolution** in the "Options" menu.
2. Select the resolution.
3. Press **OK** to confirm.
4. Then press **Return** to return to measurement mode.

5.7.1.2 Take single wavelength readings (single reading)



1. Insert the zero solution cell into the cell compartment.
2. Press **Zero**.
*Note: The **Read** key is only active after the zero reading has been completed.*
3. Insert the analysis cell into the cell compartment.
4. Press **Read**.
5. For data storage, refer to [section 5.3.1, page 38](#).

5.7.2 Multi Wavelength mode – readings with more than one wavelength

In the Multi Wavelength mode, absorbance values can be measured at up to four wavelengths and the results can be mathematically processed to obtain sums, differences and relationships.

- Absorbance readings: The light absorbed by the sample is measured in absorbance units.
- % Transmittance measures the percent of the original light that passes through the sample and reaches the detector.
- Turning on the concentration factor allows selection of a specific multiplier for converting absorbance readings to concentration. In a graph of concentration versus the absorbance, the concentration factor is the slope of the line. Concentration is calculated using a single factor for each wavelength, which is input by the user.

5.7.2.1 Set the Reading mode at different wavelengths

In the main menu, press the **Multi-Wavelength** menu option. Press **Options** for Parameter Setup.

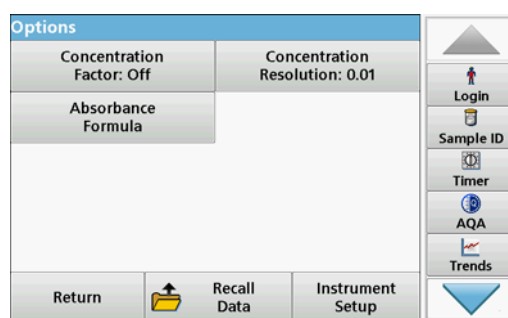
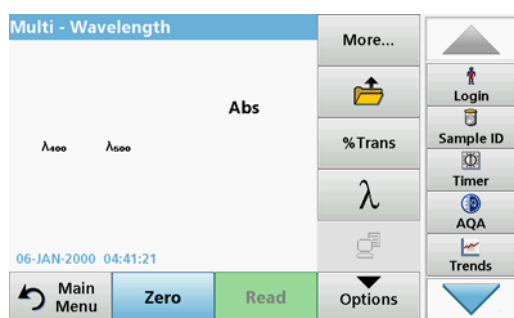

Table 8 Multi wavelength setup options

Options	Description
More	For further Options
Save icon	Symbol: Store Data , if Instrument Setup > Data Log Setup > Auto Store: Off is selected. Symbol: Recall Data , if Instrument Setup > Data Log Setup > Auto Store: On is selected.
% Trans/Abs	To switch to % transmittance, concentration or absorbance readings

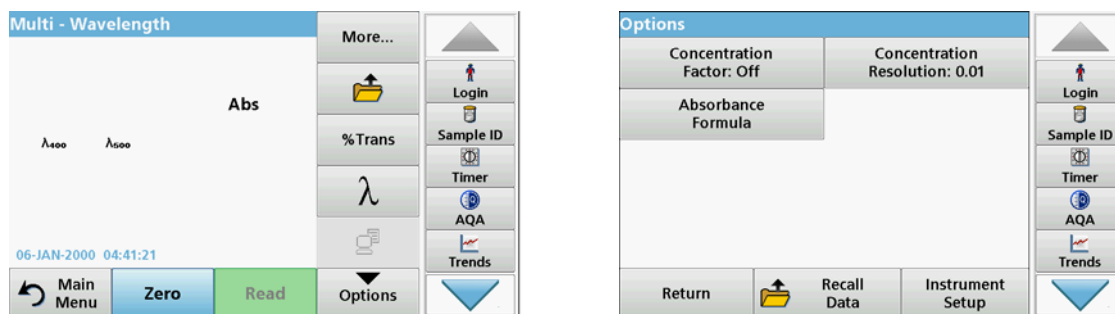

Table 8 Multi wavelength setup options(Continued)

Options	Description
λ Wavelength	To input the wavelength setting. Use the alphanumeric keypad to enter the reading wavelengths. The entered wavelength must be in the range from 320–1100 nm.
Send Data icon	To send data to a printer, computer or USB memory stick (Type A)
Concentration Factor	Multiplication factor for converting absorbance values into concentration values.
Concentration Resolution	To select the number of decimal places.
Absorbance Formula	Calculation basis for evaluating samples
Recall measurement data	Recall saved measurement data, wavelength scans or time courses, see section 5.3, page 38 .
Instrument Setup mode	Basic data of the instrument, refer to section 5.2, page 23 .



Absorbance Formula

1. Press **Absorbance Formula**.
2. The formula selected in the top key determines the number of wavelength and coefficient keys that will appear below.
3. Press the key to change the calculation formula.
4. Select a formula from the displayed list.
5. Press **OK**.

When a new formula is selected, the number of variables below changes to match.

The following formulas are available:

$$\begin{aligned}
 &K_1 A_1 + K_2 A_2 \\
 &K_1 A_1 + K_2 A_2 + K_3 A_3 \\
 &K_1 A_1 + K_2 A_2 + K_3 A_3 + K_4 A_4 \\
 &K_1 A_1 / K_2 A_2 \\
 &(K_1 A_1 + K_2 A_2) / K_3 A_3 \\
 &(K_1 A_1 + K_2 A_2) / (K_3 A_3 + K_4 A_4)
 \end{aligned}$$

A₁ refers to the absorbance at wavelength 1

A₂ refers to the absorbance at wavelength 2, etc.

K_1 refers to the coefficient at wavelength 1

K_2 refers to the coefficient at wavelength 2, etc.

If a subtraction has to be completed, the factors can be entered with a minus sign.



6. To change the wavelength, press the λx key.
7. Enter the required wavelength using the alphanumeric keypad.
8. Press **OK** to confirm the selection.



9. To change a coefficient, press one of the " K_x " keys.
10. Enter the required coefficient using the alphanumeric keypad.
11. Press **OK** to confirm the selection.

Note: Up to 5 digit number values can be entered! A maximum of four decimals places are possible.

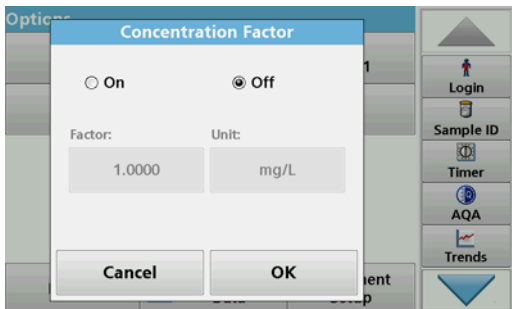

Concentration Factor:

1. Press **Concentration Factor: Off** in the "Options" menu.
2. Press **On** to activate this function.
3. Press **Factor**.
4. Enter the factor with which the absorbance measurement is to be multiplied.
5. Press **Unit**.
6. Select the respective concentration unit from the displayed list.
7. Press **OK** to confirm.

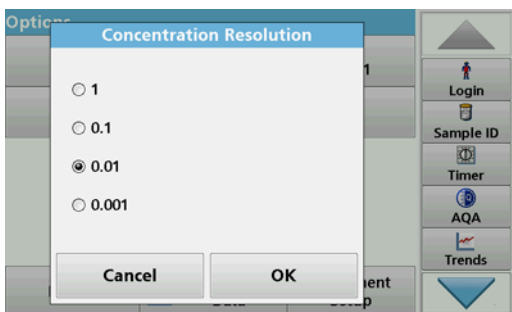

Concentration Resolution:

1. Press **Concentration Resolution** in the "Options" menu.
2. Select the resolution.
3. Press **OK** to confirm.
4. Then press **Return** to return to measurement mode.

Standard programs

5.7.2.2 Complete a reading in the Multi Wavelength mode

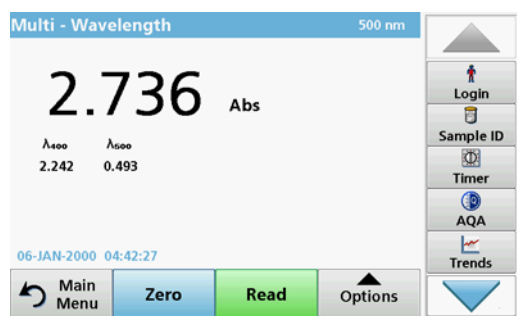

1. Insert the zero solution cell into the cell compartment.
2. Press **Zero**.
*Note: The **Read** key does not become active until the zero reading has been completed.*
3. Insert the analysis cell into the cell compartment.
4. Press **Read**.
5. For data storage, refer to [section 5.3.1, page 38](#).

5.7.3 Time course of absorbance/transmittance

The Time Course mode is used to collect data in either absorbance or transmittance for a user-specified length of time. This data can be displayed in either a graph or a table.

5.7.3.1 Time course setup parameters

1. In the main menu, press the **Time Course** menu option.
2. Press **Options** to configure parameters.

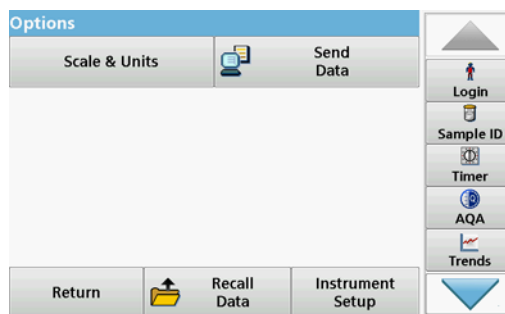
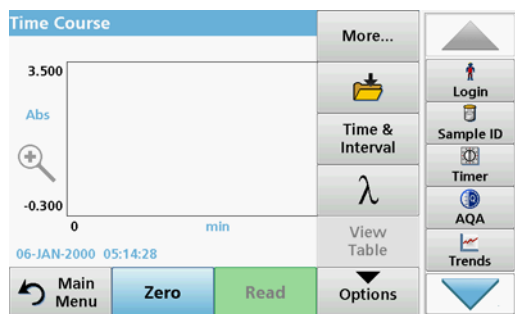

Table 9 Time course options

Options	Description
More	For further Options
Save icon	Symbol: Store Data , if Instrument Setup > Data Log Setup > Auto Store: Off is selected. Symbol: Recall Data , if Instrument Setup > Data Log Setup > Auto Store: On is selected.
Time & Interval	To input the total time for data collection and the time interval between the collection of data points.
λ	To input the wavelength setting.
View Table	To display readings in absorbance, transmittance or concentration. This can be changed after sample data is collected
Scale & Units	Scale: In the automatic Scaling mode, the y-axis is automatically adjusted so that the total scan is displayed. The manual Scaling mode allows sections of the scan to be displayed. Units: Choice of absorbance or transmittance.

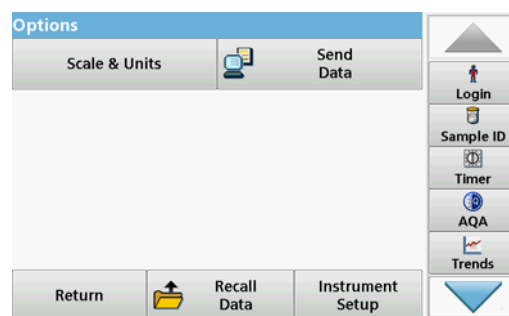
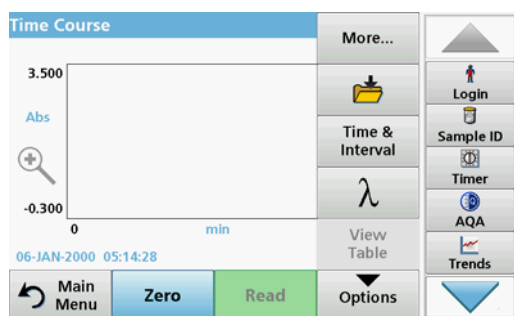
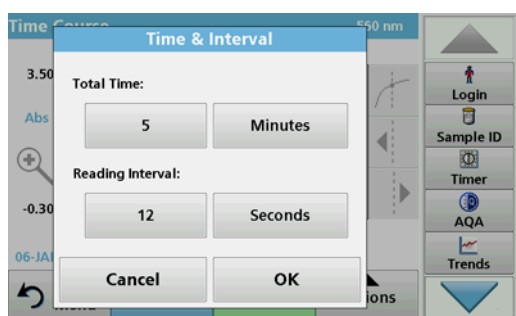

Table 9 Time course options(Continued)

Options	Description
Send Data	To send Data to a printer, computer or USB memory stick (Type A)
Recall measurement data	Recall saved measurement data, wave-length scans or time courses, see section 5.3, page 38 .
Instrument Setup	Basic data of the instrument, refer to section 5.2, page 23 .

**Time & Interval:**

1. Press the "Options" menu on the **Time & Interval** menu option.
2. Enter the total time and measurement interval.
3. Press **OK** to confirm.

Note: In total, 500 measuring steps can be accomplished during a scan. To select a total time and a time interval that would cause this number of readings to be exceeded, the time interval is defined automatically and the **OK** key is inactivated.

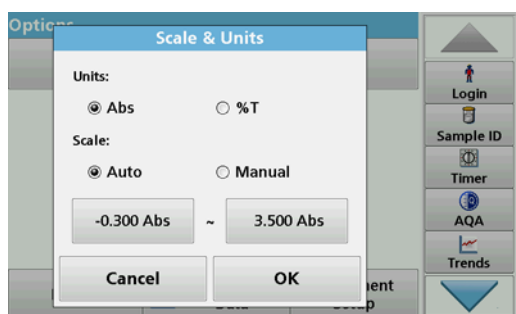
**Scale & Units:**

1. Press the "Options" menu on the **Scale & Units** menu option.
2. Highlight **Abs** or **%T** as the required units.
3. Highlight Auto or Manual scaling on the graph's y-axis.

Note: When selecting the manual scaling, the limit values y_{min} and y_{max} can be entered using the alphanumeric keypad. The graph is adjusted to display only the values in the selected range. If automatic scaling is selected, the instrument sets the limits automatically so that the total range can be displayed.

4. Press **OK** to confirm.
5. Press **Return** to return to the Scan mode.

Standard programs

5.7.3.2 Time course scan reading

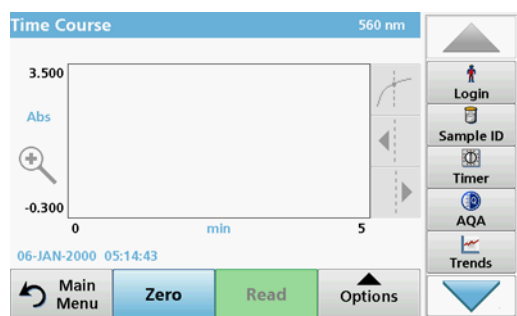

After all scan parameters have been selected, the instrument must then be zeroed. Afterward the sample can be analyzed.

1. Insert the zero solution cuvette into the cuvette compartment and close the cuvette compartment cover.
2. Press **Zero**.
The blank value is displayed on the screen.
3. Insert the analysis cuvette into the cuvette compartment and close the cuvette compartment cover.
4. Press **Read**.

The instrument will begin collecting Time Course data (kinetic data).

Note: During the reading the **Zero** and **Read** keys change to **Mark** and **Stop**.

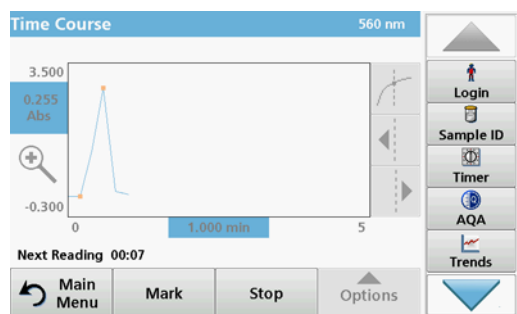

- **Mark:** Press the Mark button to mark the next measurement point visibly on the screen. This mark is not used by the instrument, but is available for the user and may indicate a significant event, such as the addition of a sample or other reagent. The mark is also shown in the table.
- Select **Stop** to stop taking sample readings.

5.7.3.3 Analysis of time course data

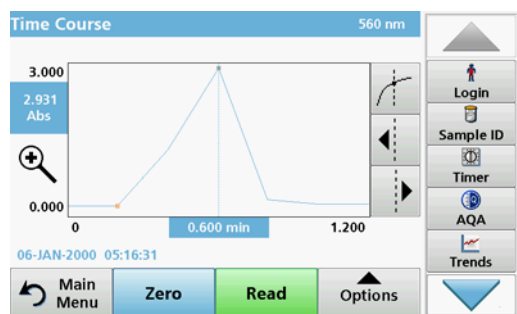

After the Time Course data has been collected, the following manipulations can be done on the graphic data:

The **Time Course** Program is complete, if

- the instrument beeps after completion of the overall time
- the graph is shown full-size,
- the scaling of the x-axis occurs automatically,
- the Cursor functions in the vertical navigation bar are highlighted.

Navigation of a time scan or a time scan analysis

After a time scan has been completed, the time and the absorbance/transmittance data is displayed as a curve.

Where the cursor is positioned on the curve, the elapsed time up to this point and the corresponding absorbance are highlighted.

Table 10 Navigating the time scan

Cursor function/ Zoom function	Description
Curve Icon (Choice of Cursor Mode)	Delta mode: A second cursor is highlighted. The position of the fixed cursor was previously defined in Cursor mode Single. Use the active cursor to select any point on the reading curve. The difference to the fixed cursor is shown on the curve. The delta values are correspondingly highlighted and displayed on the x and y axes. The gradient of the curve and the correlation coefficient (r^2) between the cursor points in the Delta mode are shown under the curve.
	Cursor mode, single: The cursor moves to each selected measuring point of the scan.
Arrow keys	The arrow keys (right/left) are used to move the cursor (depending on the selected mode) to the next data point. The data of the data point (wavelength, absorbance or transmittance value) are highlighted on the x and y axes. Note: Press any point on the curve to display the associated data.
Zoom Icon	This function is used to magnify the section of the curve in the vicinity of the cursor. The original curve size can be restored by pressing the zoom icon again.

5.7.4 Wavelength Scan mode – recording of absorbance and transmission spectrums

In the Wavelength Scan mode, the absorbance of the light in a solution over a defined wavelength spectrum is measured. While the scan is taking place, the cell compartment cover must be closed. Therefore, a scan of the round cell compartment is not possible.

The reading results can be displayed as a curve, as percentage transmittance (%T) or as Absorbance (Abs). The collected data can be printed as a table or a curve.

The data is available for formatting changes. These include automatic scaling and zoom functions. Maximum and minimum values are determined and shown as a table.

The cursor can be moved to any point on the curve for the purpose of reading off the absorbance or transmittance value and the wavelength. The data for each data point can also be displayed as a table.

Standard programs

5.7.4.1 Set up the wavelength scan

In the main menu, press the **Wavelength Scan** menu option. Press **Options** for Parameter Setup.

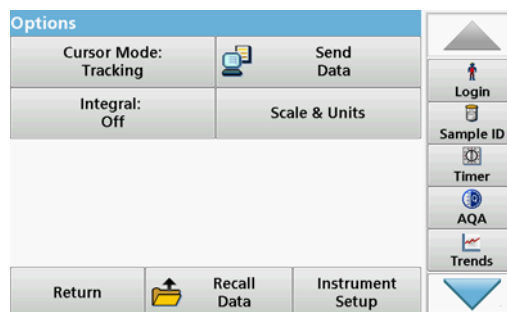
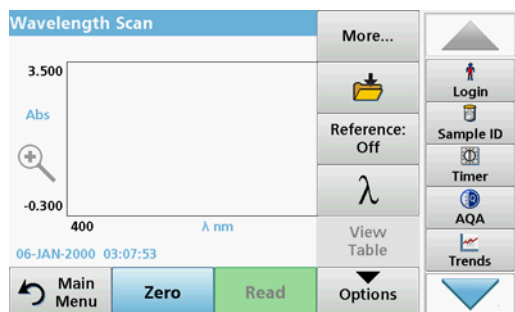
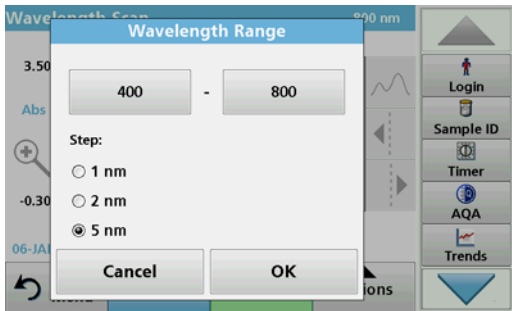

Table 11 Options during wavelength scan

Option	Description
More	For further Options
Save icon	Symbol: Store Data , if Instrument Setup > Data Log Setup > Auto Store: Off is selected. Symbol: Recall Data , if Instrument Setup > Data Log Setup > Auto Store: On is selected.
Reference Off/On	From the displayed list of stored scans, a record is selected for use as a reference scan/superimposed scan. This can be highlighted or shown in the background in comparison with the actual measured scan. Note: <i>This option is only available when there are stored scans with the same wavelength range and step.</i>
λ Wavelength	Enter the wavelength spectrum and scan interval
View Table View Graph	Enables the user to switch the display back and forth between the scan data tables (wavelength/absorbance) and the graph of the curve. Note: <i>"Select View" will be activated after the first reading.</i>
Cursor Mode	To select Track or Peak/Valley . The selection for this menu item determines to which points on the graph the cursor moves.
Send Data	To send data to a printer, computer or USB memory stick (Type A)
Integral: On/Off	The integral gives the area and the derivative of the integral gives the original function
Scale & Units	Scale: In the automatic Scaling mode, the y-axis is automatically adjusted so that the total scan is displayed. The manual Scaling mode allows sections of the scan to be displayed. Units: Choice of absorbance or transmittance.
Recall measurement data	Recall saved measurement data, wave-length scans or time courses, see section 5.3, page 38 .
Instrument Setup mode	Basic data of the instrument, refer to section 5.2, page 23 .



Set the wavelength range

1. Press the λ key in the "Options" menu to select the wavelength range and the wavelength step.
2. Press the upper left key to select the lower wavelength.
3. Enter the lower wavelength.
4. Press **OK** to confirm.
5. Press the upper right key to select the upper wavelength.
6. Enter the upper wavelength.
7. Press **OK** to confirm.

Note: Do not select the same wavelength for minimum and maximum.

8. Highlight the required wavelength step.

Note: The selection of the interval influences the duration and resolution of the Wavelength Scan. Scans with a high resolution take longer than scans with a low resolution. The larger the increments of the interval selected, the faster the scan runs. In contrast, the resolution of the determined data decreases. In summary maximally 780 measuring steps can be accomplished during a Scan.

Note: The maximum wavelength adjust automatically if the difference between the maximum and minimum wavelength is not a multiple of the interval.

9. Press **OK** to return to the Scan mode.

Selected parameters are displayed along the graph's x-axis.

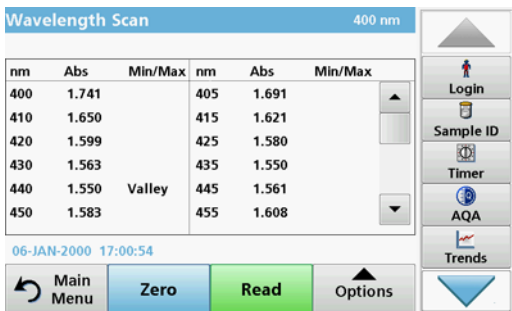

Select view (display table)

1. Perform a Wavelength Scan ([section 5.7.4.2, page 82](#))
2. Press **Display table** in the "Options" menu.
3. A table with the results is displayed.
4. To return to the graph press **Options** and then **View Graph**.

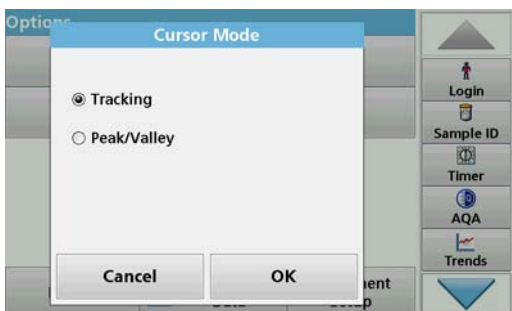

Cursor Mode

1. Press **Cursor mode: tracking** in the "Options" menu.
The selection for this menu item determines what data is displayed in the table.
2. Highlight **Track** or **Peak/Valley**.
3. Press **OK** to confirm.
4. Press **Return** to return to the Scan mode.

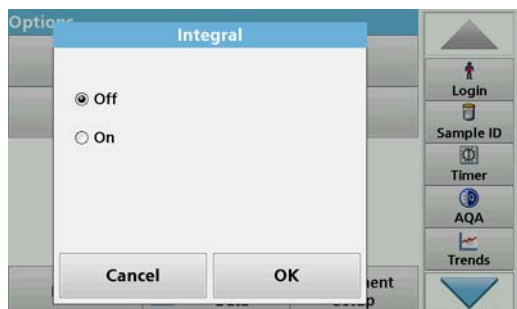

Integral

The Integral applies to the whole wavelength range of the scan.

1. Press **Integral: Off** in the "Options" menu.
2. Highlight **On** to show the Integral.
3. To find the integral of other wavelength ranges, change the wavelength range and scan again.
4. Press **OK** to confirm.
5. Press **Return** to return to the Scan mode.

Note: In measurement mode, the integral is displayed where the date is otherwise displayed.

Note: For the next scan reading the setting for the Integral will be **On**.

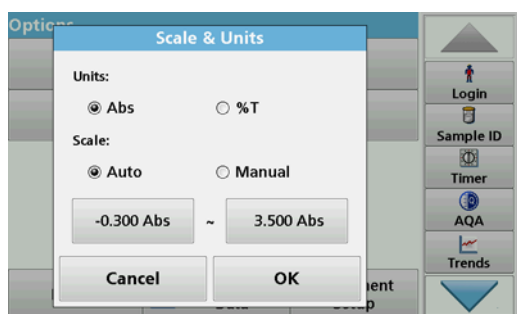

Scale & Units

1. Press **Options > More.. > Scale & Units**.
2. Highlight the required units (**Abs** or **%T**).
3. Highlight **Auto** or **Manual** scaling on the graph's y-axis.

Note: When selecting the manual scaling, the limit values y_{min} and y_{max} can be entered using the alphanumeric keypad. The graph is adjusted to display only the values in the selected range. If automatic scaling is selected, the instrument sets the limits automatically so that the total range can be displayed.

4. Press **OK**.
5. Press **Return** to return to the Scan mode.

5.7.4.2 Perform a wavelength scan

After selecting all scan parameters, record a base line (initial zero reading). If a scan parameter is changed, a new base line must be recorded. When the baseline has been scanned, the instrument is ready to scan one or more samples.

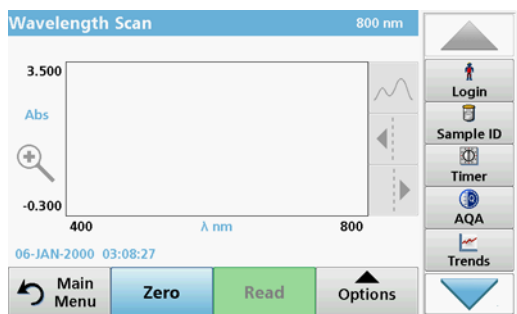

1. In the main menu, press the **Wavelength Scan** menu option.
2. Insert the zero solution cuvette into the cuvette compartment and close the cuvette compartment cover.

Note: During a scan, the cuvette compartment must be covered with the cuvette compartment cover. Therefore, no scans can be performed with 11-mm round cells.

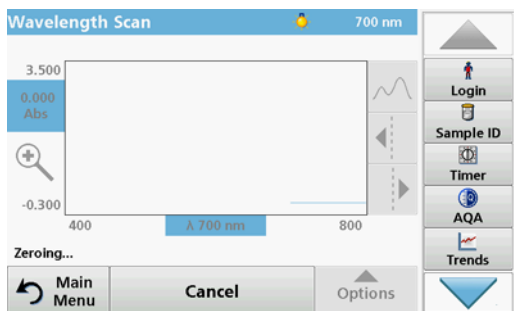

3. Press **Zero**.

During the scan of the base line, "Zero calibration" is shown in the screen.

4. Insert the prepared analysis cuvette into the cuvette compartment and close the cuvette compartment cover.

5. Press **Read**.

Under the graph, the display "Reading..." appears, and a graph of the absorbance or transmittance values for the scanned wavelengths is continuously displayed.

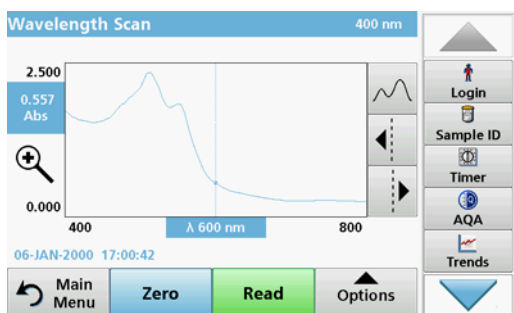

The Wavelength Scan is complete, if

- the graph is shown full-size,
- the scaling of the x-axis occurs automatically,
- the Cursor functions in the vertical navigation bar are highlighted.
- a signal sounds

Navigation of the wavelength scan graph or a wavelength scan analysis

Table 12 Navigating the wavelength scan

Cursor function/ Zoom function	Description
Curve Icon (Choice of Cursor mode)	Choice of Cursor mode Peak/Valley (cursor moves between minimum/maximum absorbance values) or Cursor mode Tracking (cursor moves over each data point of the scan).
Arrow keys	The arrow keys (right/left) are used to move the cursor (depending on the selected mode) to the next data point. The data of the data point (wavelength/absorbance or transmittance value) are highlighted on the x and y axes. <i>Note: Press any point on the curve to display the associated data.</i>
Zoom Icon	This function is used to magnify the section of the curve in the vicinity of the cursor. The original curve size can be restored by pressing the zoom icon again.

5.7.4.3 Work with reference scans

There are two options to work with **Reference Scan**:

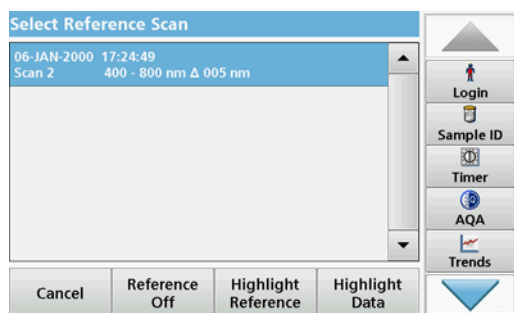

First option:

1. Press **Reference: Off** in the "Options" menu to select another scan to display on the same screen with the current scan. Highlight the required scan number and press **Highlight reference**.

*Note: Once a reference scan has been selected, the **Reference: Off** key in the "Options" menu turns into **Reference: On**.*

Note: Only scans that have the same wavelength range and step can be displayed using the overlay option. This process can be repeated until all matching scans are displayed.

- The reference curve is displayed in orange. The absorbance or transmittance value and the associated wavelength are highlighted in grey.

Note: A black and an orange field are displayed in the top left of the screen. The orange box relates to the reference scan and the black one relates to the current wavelength scan.

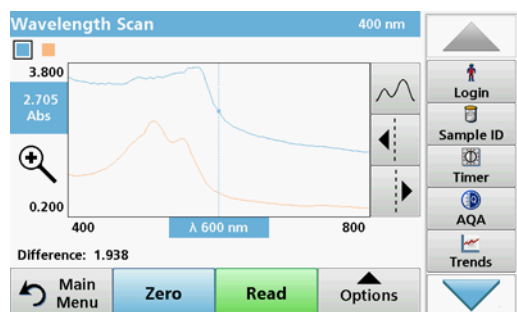

- To complete the wavelength scan reading, refer to [section 5.7.4.2, page 82](#).
 - The newly plotted wavelength scan curves are shown in black.
 - The absorbance or transmittance value and the associated wavelength are highlighted in black.
 - In addition, the display shows the difference between the wavelength scan curve and the reference curve against the wavelength.
- Press the black or orange field in the top left corner of the screen to toggle between the measured wavelength scan and the reference scan

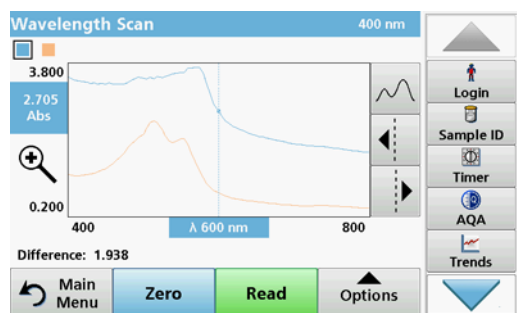

Second option:

- Insert the zero solution cell into the cell compartment. Press **Zero**.
- Insert the analysis cell into the cell compartment. Tap on **Read**.
 - The newly plotted wavelength scan curves are shown in black.
 - The absorbance or transmittance value and the associated wavelength are highlighted in black.
- Press **Options** and then **Reference: Off** in the "Options" menu to select another scan to display on the same screen with the current scan. Highlight the required scan number and press Highlight Reference.

Note: After selecting a reference scan the **Reference: Off** key in the "Options" menu turns into **Reference: On**.

Note: Only scans that have the same wavelength range and step can be displayed using the overlay option. This process can be repeated until all matching scans are displayed.

4. The reference graph is displayed in orange. The absorbance or transmittance value and the associated wavelength are displayed in orange.
 - In addition, the difference of the absorbance and/or transmittance value between the two scans (measured scan and reference scan) is indicated/highlighted at each position of the cursor.

***Note:** A black and an orange field are displayed in the top left of the screen. The orange box relates to the reference scan and the black one relates to the current wavelength scan.*

5. Press the black or orange field in the top left corner of the screen to toggle between the measured wavelength scan and the reference scan

Section 6 Advanced Operations

6.1 System Checks

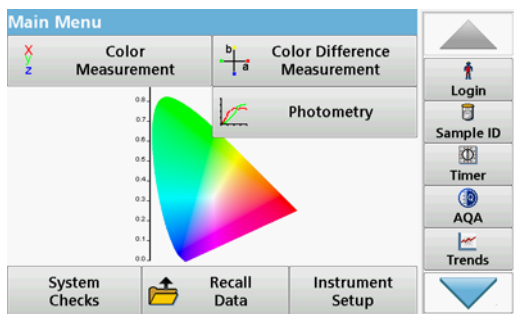

1. Press **System Checks** in the Main Menu.

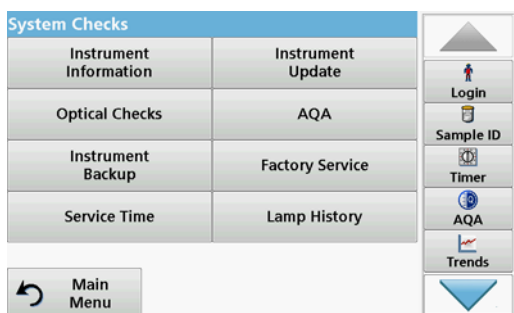

The "System Check" menu contains instrument information and various performance tests.

6.1.1 Instrument Information

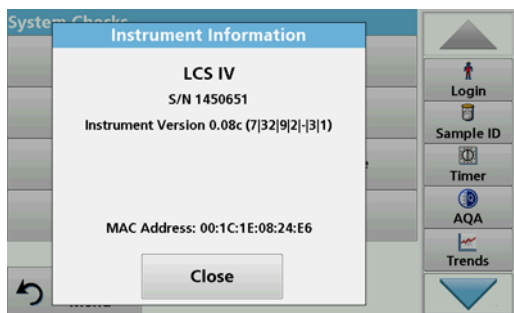

1. Press **Instrument Information** in the "System Check" menu.
2. The model, serial number and software version are displayed.

6.1.2 Update the instrument software

6.1.2.1 Software update with USB memory

To obtain the software for the update from the Internet.



1. Tap on **Instrument Update** in the "System Checks" menu.
2. Plug the USB storage device into the USB port (USB A) of the device, refer to [section 3.5, page 16](#).
3. Press **OK**. The link is established automatically and the software is updated.
4. Press **OK** to return to the "System Check" menu.

Note: After the instrument update, a prompt to restart the instrument will be displayed.

6.1.3 Optical Checks

The Verification Kit (refer to [Section 9, page 107](#)) is designed for periodic monitoring of scattered light, photometric accuracy and the wavelength accuracy of the spectrophotometers.

When results exceed allowable tolerances (given in the quality control certificate to the test record), contact the manufacturer.

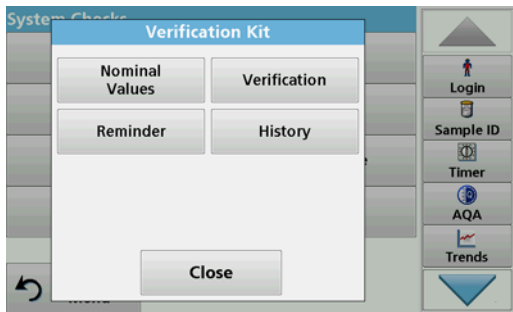

1. Press **Optical Checks** in the "System Check" menu.
2. Press **Nominal Values**.

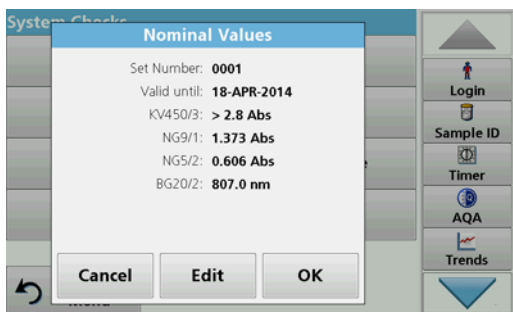

3. Press **Edit**.

An automatic menu guidance queries values (filters, wavelength, nominal values and tolerances) given in the quality control certificate, to the following specifications:

- Stray light
- Photometrical accuracy
- Wavelength accuracy

4. Press **OK** when all values are entered and the overview is displayed.

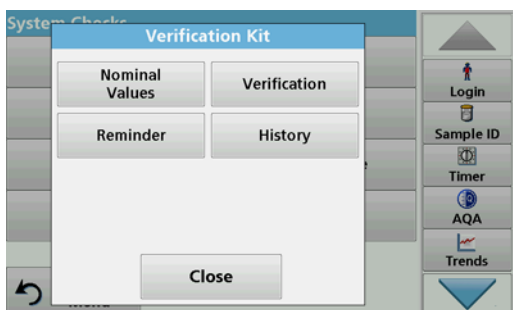

5. Press **Verification**.
6. Insert cuvette adapter Z ([Figure 3, page 18](#)) into the cuvette shaft (2).

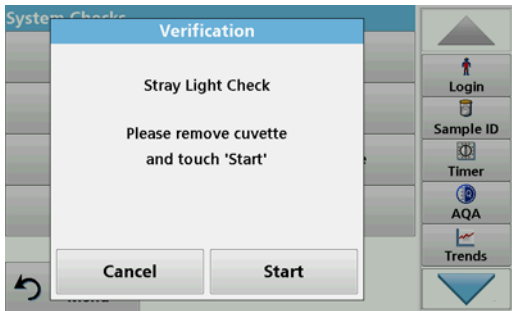

7. Remove any present cuvettes from the cuvette compartment.
8. Close the cuvette compartment cover.
9. Press **Start**.

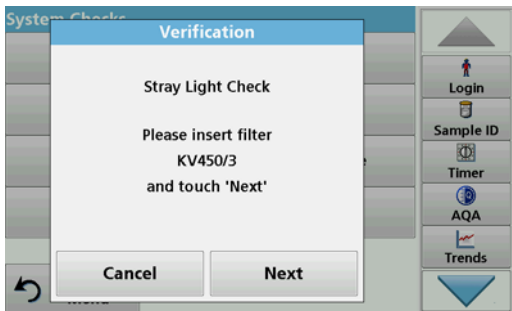

10. Follow the instructions on the screen and insert the different filters one after another in the sequence shown.
11. Press **Next** after inserting a filter.

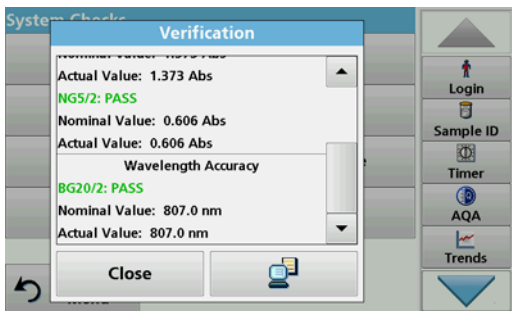

- After the last reading the results are displayed.
12. Press **PC & Printer** icon to send the data to a USB memory stick, PC or to a printer.

The files will be stored automatically as CSV files (Comma Separated Value). The file name will be formatted as "Verification.csv".

6.1.4 AQA Analytical Quality Assurance

6.1.4.1 Standard Configuration

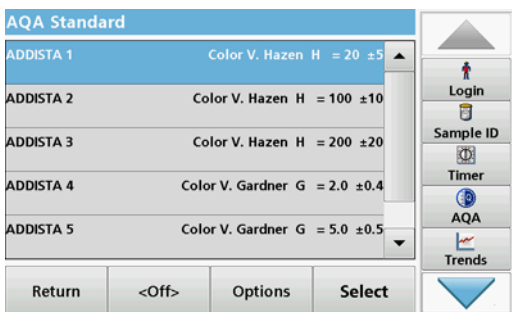

Analyzing an AQA standard solution enables you to check your working procedure, photometer and accessories.

1. Under "System Check", select **AQA**,
or
press **AQA** in the **toolbar** on the right of the screen.
A list of standard solutions opens.

Advanced Operations

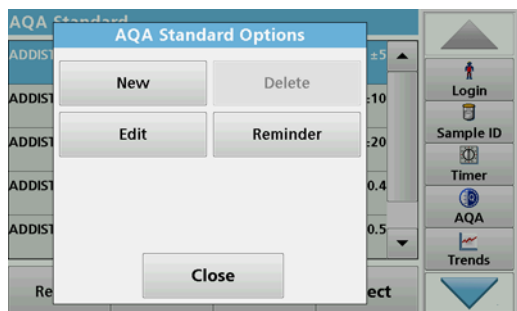

2. Select **Options > New** to define a new standard.

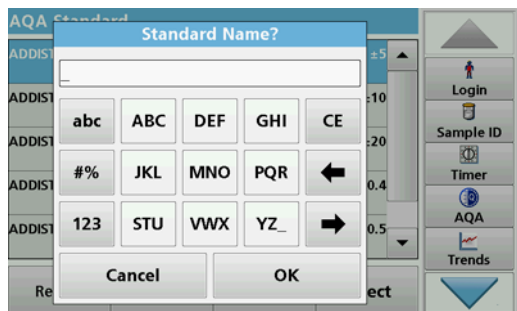

3. Enter the **name** of the standard solution and confirm with **OK**.

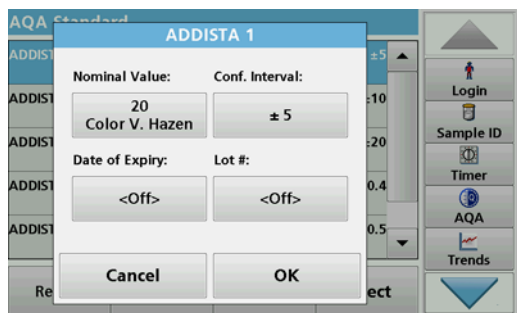

4. Enter the **concentration, unit, confidence range** and **unit** by pressing the relevant fields.
5. Press **OK** to confirm the entry.

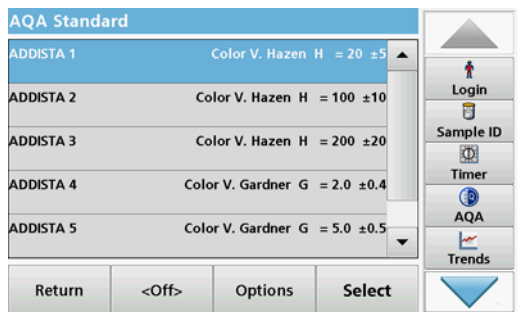

6. All the standard solutions entered are shown on the screen.

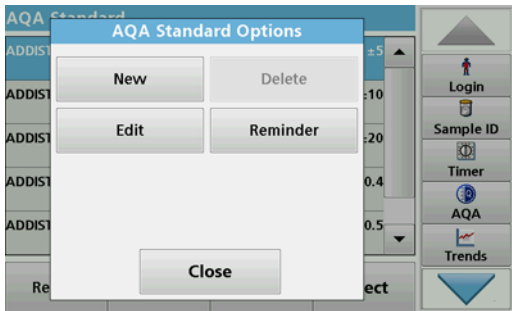

7. Select **Options** for further editing.
 - Select **New** to define a new standard.
 - Select **Edit** to change the settings.
 - Select **Delete** to delete the standard. Only user-programmed standards can be deleted.
 - Select **Reminder** to enter an automatic interval at which you are prompted to take a standard measurement.

6.1.4.2 Perform AQA Standard Measurement

If you have set a reminder function, you will be prompted to take the AQA standard measurement after a set interval has elapsed.



1. Select the required AQA standard. The AQA button in the toolbar is displayed in yellow.
2. Take the standard measurement.

6.1.5 Instrument backup

Prior to the next service date, the "Instrument Backup" offers the opportunity to store all programs, measurement data, user IDs, passwords, as well as all adjustable data on a USB stick.

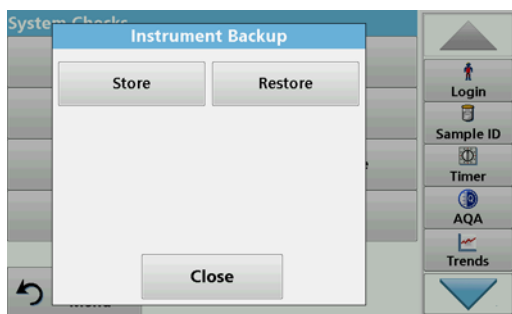

1. Press **Instrument Backup** in the "System Check" menu.
2. Insert the USB stick (refer to [section 3.5, page 16](#)).
3. Press **Store** to start a Backup.



If the file was stored, the message "Instrument Backup is stored" will be displayed.

4. Press **OK** to return to the "System Check" menu.

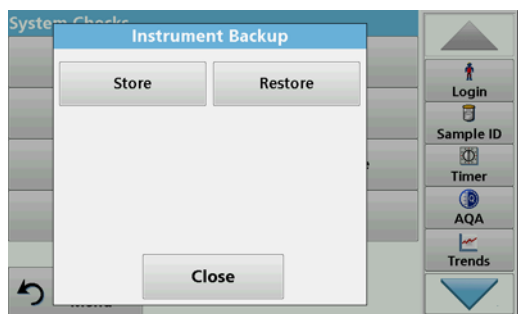

Restore backup data:

Note: All current data will be overwritten when restoring the Backup file!

1. Press **Instrument Backup** in the "System Check" menu.
2. Insert the USB stick with the backup (refer to [section 3.5, page 16](#)).
3. Press **Restore** to pass back the data.
4. The report "Restore instrument backup from S/N XXXXXXXX. "Restore?" displays the serial number of the instrument relating to the backup. Press **OK** to confirm.
5. Restart the instrument after the backup is complete.

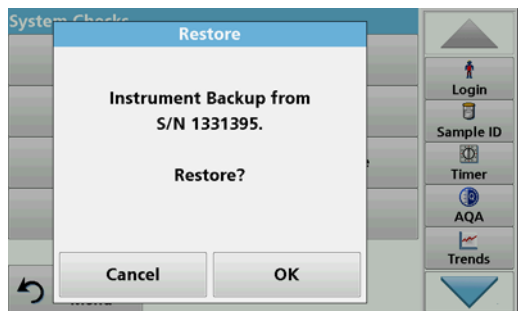

6.1.6 Service menu



Use of the service menu requires a service code. This menu is reserved exclusively for the service staff of the manufacturer for service work.

6.1.7 Service time

In order to make sure a regular inspection is performed, an automatic memory reference for the service times can be entered. After switching the instrument on, this memory reference will be activated and indicated at the appropriate time.

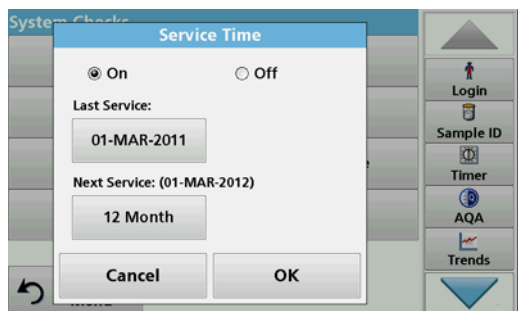

1. Press **Service Time** in the "System Check" menu.
2. Activate the **On** checkbox.
3. Press **Last service**.
4. Enter the date of the last service.
5. Press **OK** to confirm the selection.

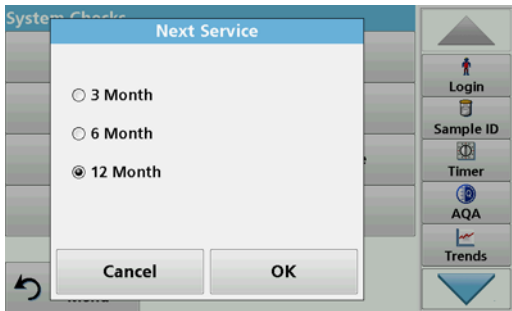

6. Activate the options field under **Next service**.
7. Select a time interval for the next service.
8. Press **OK** to confirm the selection.

When the next service is due the report "**Next service due!!**" is displayed when the instrument is switched on.

9. Press **OK** to return to the Main Menu.

Contact the manufacturer to schedule the next service date.

6.1.8 Lamps operating time

The "Lamps operating time" provides information on the switch-on cycles of the lamps.

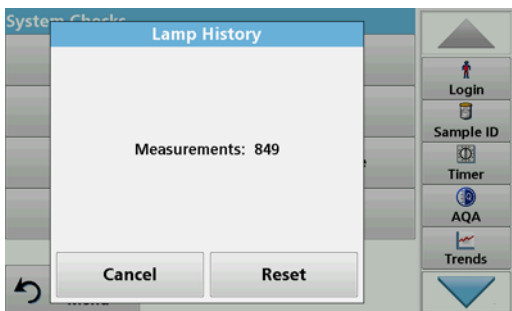

After a lamp is replaced, the display of the switch-on cycles is reset to 0.

1. Press **Lamp History** in the "System Check" menu.
2. Press **Reset** and the lamp data are reset.
3. Press **OK** to return to the "System Check" menu.

6.2 Toolbar

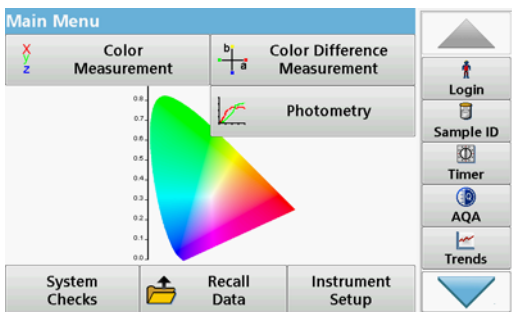

There is a toolbar with various programs on the right-hand side of the screen. Many of these programs can also be called up via a menu but the operation is the same.

6.2.1 Log on

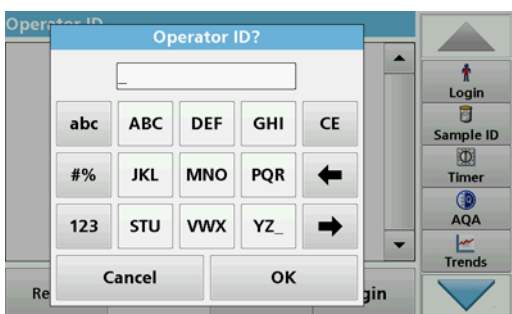

Use this function to enter up to 30 different operator initials (up to 10 characters each) into the instrument. This feature helps record which operator measured each sample. For a detailed description, refer to [section 5.2, page 23](#).

6.2.2 Sample ID

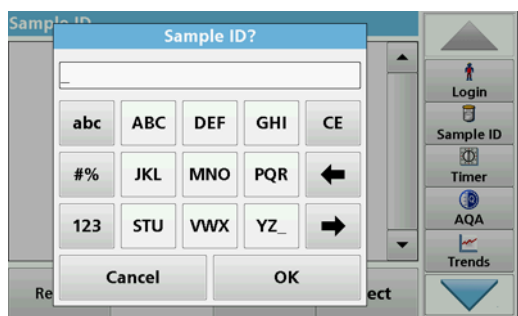

Use this function to enter up to 100 different sample designations (each with max. 20 characters) into the instrument. Sample IDs can be used to specify the sample location or other sample specific information, for example. For a detailed description, refer to [section 5.2.2, page 24](#).

6.2.3 Timer

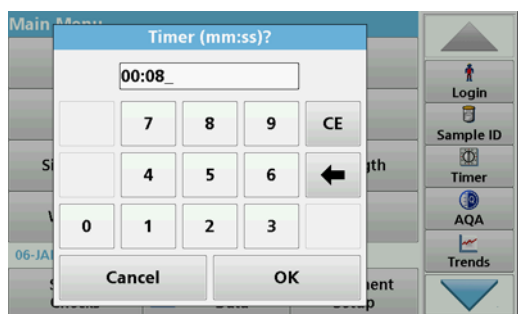

Use this function to activate a timer at any time.

1. In the toolbar, press **Timer**.
2. Enter the required time and confirm with **OK**.

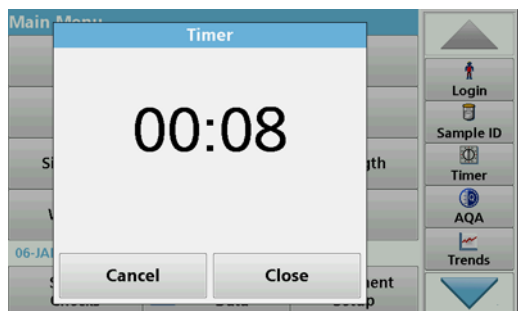

The count-down starts automatically.

3. Press **Close** to let the timer run in the background. Press **Cancel** to stop the timer.
4. When the timer has finished a sound is emitted.

6.2.4 AQA

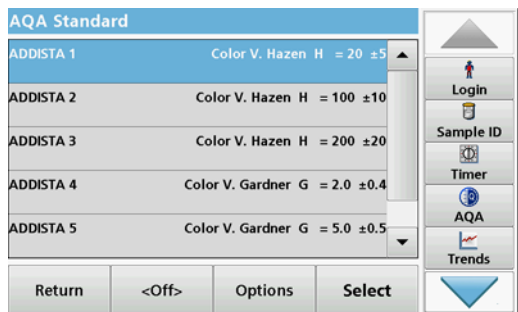

Analyzing an AQA standard solution enables you to check your working procedure, photometer and accessories. Press **AQA** in the **toolbar** on the right-hand side of the screen to open a list of standard solutions. For a detailed description, refer to [section 6.1.4, page 89](#).

6.2.5 Trends

Use this function to call up a load curve of the stored measurement values for each parameter or sample location. The concentration of the corresponding parameter is shown graphically over time. For a detailed description, refer to [section 5.3.5, page 50](#).

⚠ CAUTION

Potential Chemical, Biological Eye and Skin Hazards.
Only qualified personnel should conduct the tasks described in this section of the manual.

NOTICE

Remove all cells remaining in the instrument. Dispose of the cells or their contents in an authorized manner.

7.1 Cleaning requirements

⚠ CAUTION

Potential Pinch, Eye, Burn and Chemical Hazards.
Before cleaning, always disconnect the instrument from the power source.

NOTICE

Under no circumstances may solvents such as turpentine, acetone or similar be used to clean the instrument, including the screen and accessories.

7.1.1 Spectrophotometer

- Only clean the housing, the cell compartments and all accessories with a soft, damp cloth. A mild soap solution can also be used.
- Do not get excess water in the cell compartments.
- Do not insert a brush or sharp object into cell compartment #1 to avoid damaging the mechanical components.
- Dry the cleaned parts carefully with a soft cotton cloth.

7.1.2 Screen

- Do not scratch the screen. Never touch the screen with pens, pencils or similar sharp objects.
- Clean the screen using a soft, lint-free and oil-free cotton cloth. Diluted window cleaner liquid can also be used.

7.1.3 Cuvettes/cells

⚠ CAUTION

Potential Chemical/ Biological Exposure Hazards.
User correct laboratory practices if a risk of chemical exposure exists.

1. After use, clean the glass cells with cleaning agents.
2. Afterwards, rinse the cuvettes/sample cells several times with tap water and then thoroughly with deionized water.

Note: Glass cuvettes that contained organic solvents (such as chloroform, benzene, toluene etc.) must be rinsed out with acetone before being treated with cleaning agent. In addition, another rinse with acetone is necessary as a final treatment step before the cuvettes/sample cells are dried.

7.2 Lamp replacement

⚠ CAUTION

To avoid the risk of electric shock, disconnect the instrument from the power source before the lamp replacement procedure is commenced.

1. Switch off instrument.
2. Remove the power cable from the instrument.
3. Turn the instrument to allow work access to the underside.
4. Use a slotted screwdriver to loosen the screws on the cover of the lamp compartment.
5. Remove the cover.

⚠ CAUTION

Burn hazard.
Wait until the lamp cools down. Contact with the hot lamp can cause burns.

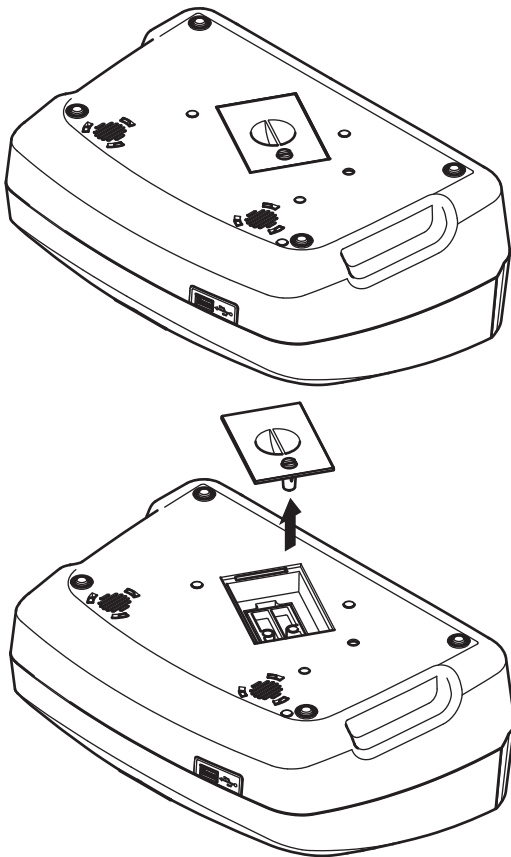

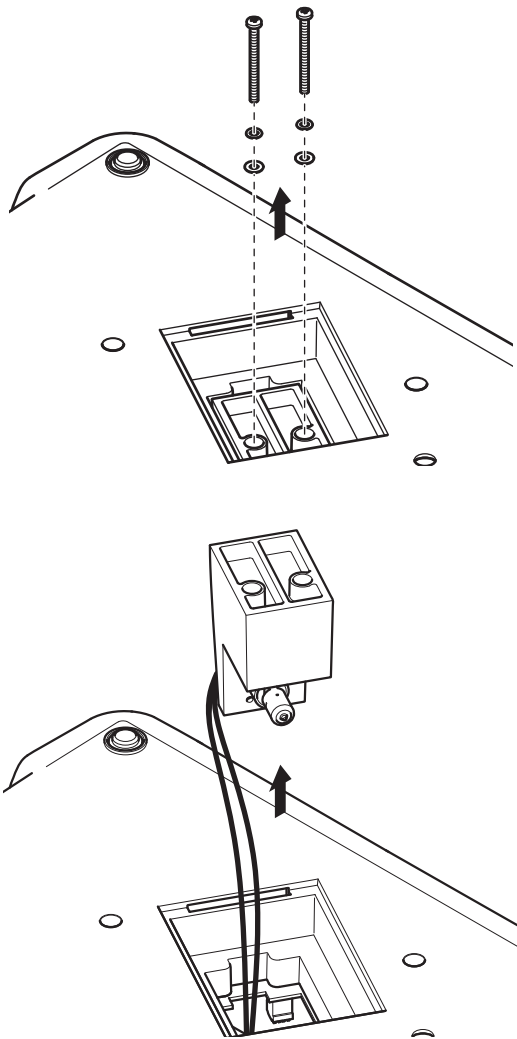

6. Using a cross-head screwdriver, remove the two screws from the lamp holder.

7. Lift out the lamp holder upwards.

8. Turn the lamp holder so that the connector with the cable guide points forwards.

9. Push the clamp slide as far as possible to the right (Step 1).

10. Grasp the connector along with the lamp, pulling it out of the lamp holder (Step 2).

11. Release the connector from the lamp (Step 3).

Figure 5 Lamp replacement

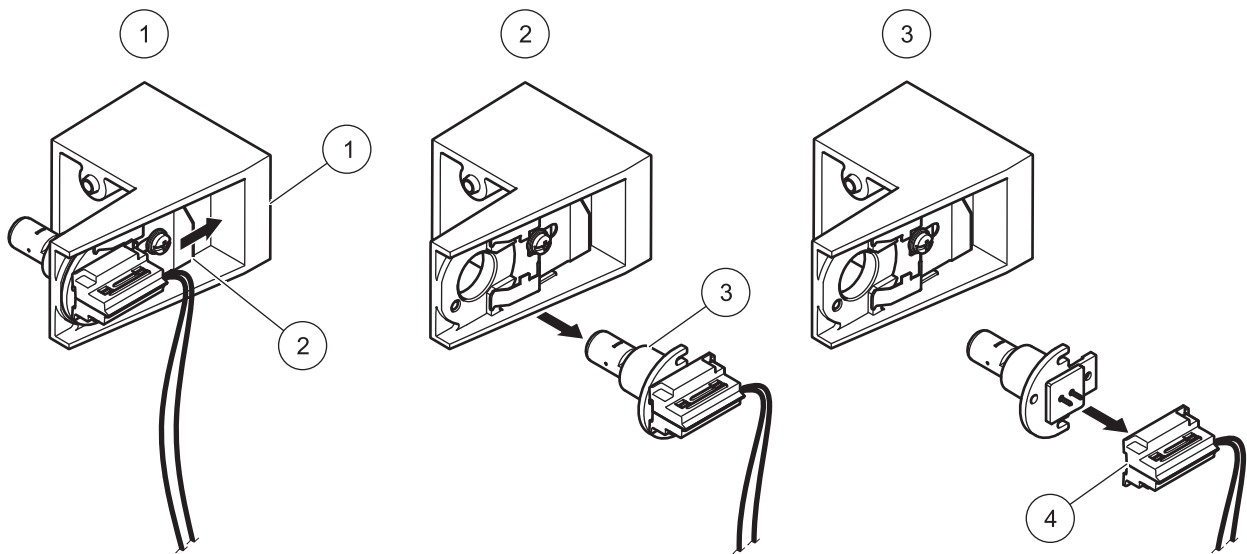

1	Lamp holder	3	Lamp
2	Clamp slide	4	Connector

To fit a new lamp carry out the procedure in reverse.

NOTICE

Only hold lamp at lamp holder. Avoid touching the glass, as substances on the skin can bake onto the lamp bulb and thus accelerate the ageing process of the lamp.

1. Connect a new lamp to the connector.
2. Install the lamp with the connector in the lamp holder.
3. Secure the lamp with the clamp slide. To do this, push the connector downwards and push the clamp slide as far as possible to the left.
4. Install the lamp holder in the instrument.
Note: Take care that the lamp cable is not pinched by the cable guide.
5. Using a cross-head screwdriver, tighten the two screws on the lamp holder.
6. Put the lamp compartment cover back into position.
7. Using a slotted screwdriver, tighten the screws on the cover.
8. Connect the power cable to the instrument.
9. Reset the lamp operating time [section 6.1.8, page 93](#).

7.3 Cell compartment (2) replacement

CAUTION

To avoid electric shock, disconnect the instrument from the power supply before replacing the cuvette compartment.

If there is severe soiling, the complete cell compartment (2) can be replaced.

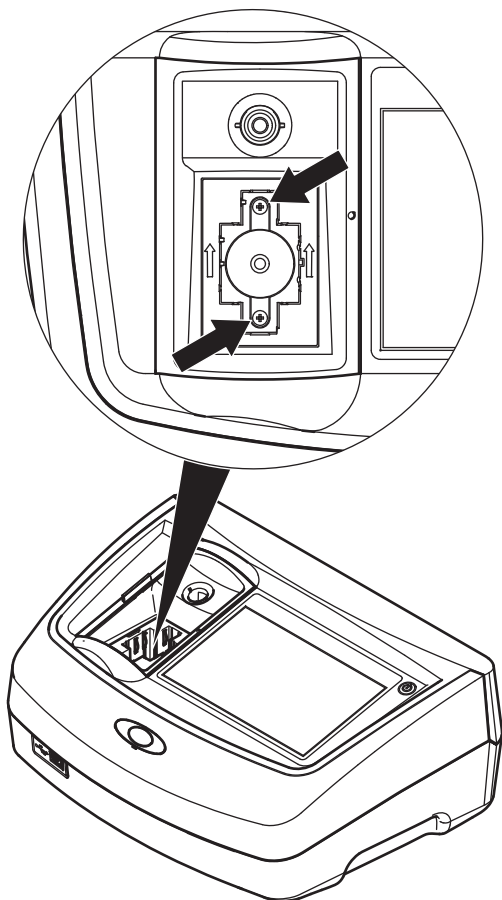

1. Switch off instrument.
2. Remove the power cable from the instrument.
3. Open the cuvette compartment cover and remove cuvette adapter Z.
4. Using a cross-head screwdriver, loosen the two screws on the bottom of the cuvette compartment.

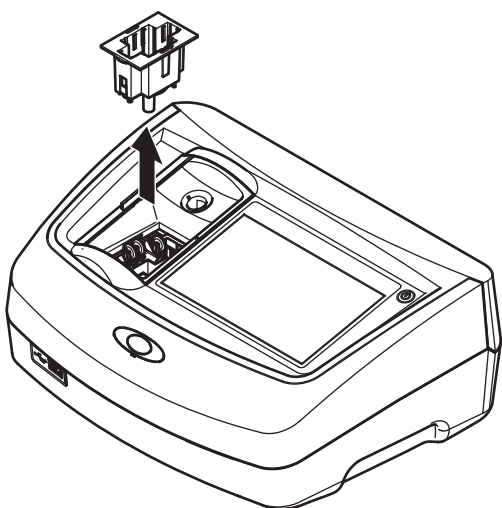

5. Lift the cuvette compartment upward and out.
6. Insert the new cuvette compartment so that the guide slots of the pressure rollers are on the left.
7. Using a cross-head screwdriver, tighten the two screws on the bottom of the cuvette compartment.
8. Connect the power cable to the instrument.
9. Insert cuvette adapter Z again.

Section 8 Troubleshooting

Error displayed	Definition	Resolution
An error occurred when uploading the instrument data.		Restart the process or contact the manufacturer or national agent.
An error occurred when reading from the USB memory stick.		Restart the process or contact the manufacturer or national agent.
An error occurred when writing to the USB memory stick.		Restart the process or contact the manufacturer or national agent.
Please check on the current update file.	Error during update.	Check the USB memory stick.
Please contact Customer Service.	Error during update.	Contact the manufacturer or national agent.
Please check network configuration.		See section 5.2.6.4, page 35 .
Please check the connection.		See section 5.2.6.4, page 35 .
Please close the cover.		Close the cuvette compartment cover.
Please insert the USB memory stick.		Insert a USB memory stick into a USB A port on the instrument.
Please check the connection and contact the administrator.	Network setup or FTP error	Refer to section 5.2.6.4, page 35 or contact the manufacturer or national agent.
File for instrument update missing.	Error during update.	Check the USB memory stick.
File for instrument update is faulty.	Error during update.	Save the update file again and repeat the procedure.
It's recommended to execute a Full System Check	Check of the air values failed	Switch the instrument off and then back on again. If the system test is unsuccessful, contact the manufacturer or national agent.
Entry invalid!	Password incorrect	Forgotten your password? Contact the manufacturer or national agent
Absorbance > 3.5!	The measured absorbance exceeds 3.5	Dilute sample and measure again
Color = ***	Color value outside measurement range.	Dilute the sample or select appropriate color scale.
Error when calling up the local IP address.	Network setup: DHCP client has no connection to the DHCP server	Enter the IP address again.
Error during default gateway setup.	Network setup: default gateway cannot be set for fixed IP address	Try to create the connection again.
Error during network drive setup!	Error during network setup	Check the settings.
Error during subnet mask setup.	Network setup: Subnet mask cannot be set for fixed IP address	Enter the subnet mask again.
Error copying from USB memory stick.	Error during update	Restart the process or contact the manufacturer or national agent.
Error in FTP connection.	FTP error	Make sure that the instrument is connected to the network.

Troubleshooting

Error displayed	Definition	Resolution
Fault Test program stopped! Please check lamp Close the lid. Error [xx]	Test program stops when the instrument is started	Check the lamp and replace it if necessary. Close lid. Press Start Again .
Fault Test program stopped! Please remove the cuvette Close the lid.	Test program stops when the instrument is started	Remove the cuvette/sample cell from the cell compartment. Press OK .
Error Selfcheck stopped. Hardware error. Error [x]	Electronic defect	Contact the manufacturer or national agent and specify the error number.
Error Too much ambient light! Move instrument into shade or close the lid	The instrument sensors detects too much ambient light.	Decrease ambient light. Avoid direct sunlight. Close lid.
No instrument backup present!		Check the USB memory stick.
No valid data for these parameters!	Data analysis not possible, no measurement data	Change the selection.
No valid data found!	Data cannot be viewed in the data log	Change the selection.
No measurement data present!	Data analysis settings cannot be configured without measurement data.	Change the selection.
Control range not reached!	Data analysis limits not reached	This is a warning notice. The control limit set was not reached.
Control range exceeded!	Data analysis limits exceeded.	This is a warning notice. The control limit was exceeded.
Concentration too high!	Calculated concentration is higher than 999999	Dilute sample and measure again
Possible interference by:	Interference Check	The analysis is possibly erroneous due to interferences.
Possible interference from:	Interference Check	The analysis is possibly erroneous due to interferences.
Next service is due!		Contact the manufacturer or national agent for an instrument service. For setting the service reminder, refer to section 6.1.7, page 92
Negative result!	The calculated result is negative	Check concentration of sample
Network switched off.	Network setup off, when access to homepage via sidebar	Activate the online connection.
Remote server cannot be reached.	Error during network setup	Make sure that the instrument is connected to the network.
Unstable lighting conditions!		Avoid direct sunlight at the measuring location.
Please insert adapter Z.	For measurements with 11 mm round cuvettes, adapter Z is required.	Insert adapter Z into cell compartment #2. Confirm with OK.
Insufficient memory for update .	Error during update.	Select a memory with more space.

Error displayed	Definition	Resolution
System check incorrect!	Measurement of air values failed	Switch the instrument off and then back on again. If the system test is unsuccessful, contact the manufacturer or the national agent.
Temperature too high. Measurement not possible!		Switch of the instrument and allow it to cool for a few minutes. If necessary, move it to a cooler place.
Update file is faulty.	Error during update.	Save the update file again and repeat the procedure.
USB memory stick is not connected.	Update not possible.	Check the USB memory stick.

Section 9 Service and Certification

Deutschland

BYK-Gardner GmbH
Lausitzer Strasse 8
82538 Geretsried
Deutschland
Tel.: +49-8171-3493-0
Fax: +49-8171-3493-166

USA

BYK-Gardner USA
9104 Guilford Road
Columbia, MD 21046
USA
Tel.: +1-301-483-6500
Fax: +1-301-483-6555

China

BYK-Gardner China
Instruments Service
BYK (Tongling) Co., Ltd.
Shanghai Branch
3/F, Bldg A, No8, Lane 1305
Huajing Road, Xuhui District
Shanghai 200231
P.R. China
Tel.: +86(021)6496-7931
Fax: +86(021)6496-7932

Brasilien

BYK-Gardner Latin America
Rua Itaporanga, 340
Bairro Paraíso -Santo
André-SP
CEP 09190-640
Brazil
Tel.: +55-11-2147-1199
Fax: +55-11-2147-1168

Index

A

Absorbance Formula	74
Acid wash color	66
ADMI color number	65
Alphanumeric keypad	21
APHA method	58
ASTM D 1500	59
ASTM D 156	59
ASTM D 1925	65
ASTM D848 - 09	66
Audio signals	32

C

Cell compartment (1)	16
Cell compartment (2)	17
Chinese Pharmacopoeia	64
Cleaning	
Display	97
Spectrophotometer	97
color difference	67
Concentration Factor	72, 74, 75
Concentration Resolution	72, 74, 75
Cursor Mode	80, 81
Cuvette compartment cover	14
Cuvettes/cells	98

D

Data	
deleting	38, 42, 47
recalling	38, 47
sending	38, 47
storing	38, 47
Data Folder	37
Data log	7
Data Storage	48
Date and time	30
Default Gateway	36
DIN 6162	58
DIN-ISO 2049	59
DIN-ISO 4630	59
DIN-ISO 6271	58
Display	21, 97
Display and Sound	32
Display mode	7
Disposal	9
Drift Check	93

E

Ethernet communication	35
------------------------------	----

Ethernet port	16
European Pharmacopoeia	59

F

Factory Service	92
Filter Settings	40, 45

G

Gardner color value	59
---------------------------	----

H

Hazen color value	58
Hess-Ives color number	65

I

ICUMSA color index	66
Instrument Backup	91, 92
Instrument Information	87
Instrument Setup	22, 23, 72, 74, 77, 80
Integral	80, 82
Interfaces	16, 32
Internet	87
Iodine color value	58
IP address	35

K

Klett color number	64
--------------------------	----

L

lamp	10
Lamp History	93
Language	19
local networks	35
Lovibond scale	65

M

Main menu	22
Maintenance	97
Marking	78
Mineral oil color value	59
Multi Wavelength	22, 73, 74, 75, 76

N

Network setup	35
---------------------	----

O

Operator ID	23
Optical Checks	88, 89, 93
Output Checks	93

Index

Overview of Product/Function	10	Startup melody	19
P		Startup process	19
Password	27, 38	Stored Data	39
deactivate	30	Stored programs	71
PC and Printer	32, 33, 34	Stray light	7
Pharmacopoeia		Subnet Mask	36
European	59	System Check	19, 92
US	63	System Checks	22, 87, 89, 91, 92, 93
Photometric accuracy	7	T	
Photometric linearity	7	Time & Interval	76, 77
Photometric measuring range	7	Time Course	22, 48, 49, 50, 76, 77, 78
Photometry	71	Time course	78
Power cable	13	Time course scan reading	78
Prepare sample	53	Timer	32
Printer Setup	33	Toolbar	93
Printing data	34	Touch screen	21
Program overview	22	Troubleshooting	103
R		U	
Recall	22	Unpacking the instrument	13
Recall Data	48, 72, 74, 77, 80	Update	87
Reference	70	US Pharmacopoeia	63
Reference Scan	80, 83	USB port type A	14
reference values	70	USB port type B	15
Replaceable cuvette compartment	100	V	
S		Verification Kit	93
Safety information	9	View Table	76
Sample ID	24	W	
creating	24	Wavelength	72, 74
deleting	26	Wavelength accuracy	7
Saybolt color number	59	Wavelength calibration	7
Scale & Units	76, 77, 80, 82	Wavelength Check	89
Scanning speed	7	Wavelength Range	7, 81
Security List	27	Wavelength reproducibility	7
Select View	81	Wavelength resolution	7
Self-Check	19	Wavelength Scan	22, 48, 49, 50, 79, 80, 81, 83
Send Data	41, 46, 77, 80	Wavelength selection	7
Server Name	37	Wavelength setting	76
Service Time	92	Wavelength spectrum	80
Single Wavelength	22, 72	Y	
Software	87	Yellowness Index	65
Source lamp	7		
Specifications	7		
Spectral bandwidth	7		

Free Manuals Download Website

<http://myh66.com>

<http://usermanuals.us>

<http://www.somanuals.com>

<http://www.4manuals.cc>

<http://www.manual-lib.com>

<http://www.404manual.com>

<http://www.luxmanual.com>

<http://aubethermostatmanual.com>

Golf course search by state

<http://golfingnear.com>

Email search by domain

<http://emailbydomain.com>

Auto manuals search

<http://auto.somanuals.com>

TV manuals search

<http://tv.somanuals.com>