

# Gateway 901 Series Family Room Media Center User's Guide

Gateway®





# Table of Contents

<b>Chapter One: Setting Up Family Room Media Center</b>	<b>1</b>
About your Family Media Center	2
Planning your Family Media Center setup	3
Locating connections	3
Connections overview	4
Setting up the hardware	6
Setting up and synchronizing the wireless keyboard and mouse	8
Connecting the audio and video source	12
Connecting the IR control cable	14
Connecting a display device	15
Connecting an audio system	17
Setting up the software	19
<b>Chapter Two: Getting Started</b>	<b>21</b>
Checking out your Gateway Family Media Center	22
Front	22
Back (Gateway FMC-901 Media Center)	25
Back (Gateway FMC-901X Media Center)	27
Learning about the remote	30
Using the remote	31



Learning about the wireless mouse	32
Using the wireless mouse	33
Fine-tuning the wireless mouse pointer control	34
Changing the wireless keyboard or mouse channels	38
Determining the wireless keyboard or mouse channels	35
Turning the wireless keyboard or mouse power on or off	35
Learning about the wireless keyboard	36
Starting the Windows XP Media Center	38
Using the Windows XP Media Center	39
<b>Chapter Three: Using My TV</b>	<b>42</b>
Watching TV	42
Using the remote to play TV recordings	43
Using the Guide	45
Manually updating the Guide	46
Recording TV programs	47
Using Recorded TV	49
Changing My TV Settings	50
Burning recorded TV programs to DVD	51
<b>Chapter Four: Using My Music</b>	<b>53</b>
Getting started with My Music	54
Adding music files to the Media Library	54



Adding music CDs to the Media Library	55
Playing My Music	57
<b>Chapter Five: Using My Pictures</b>	<b>61</b>
Getting started with My Pictures	62
Organizing picture files	63
Viewing My Pictures	64
Using More Info	65
Playing audio during a slide show	66
<b>Chapter Six: Using My Videos</b>	<b>67</b>
Getting started with My Videos	68
Organizing video files	69
Viewing My Videos	70
Using More Info	71
<b>Chapter Seven: Using Play DVD</b>	<b>73</b>
Playing a DVD	74
<b>Chapter Eight: Using Radio</b>	<b>77</b>
Playing the Radio	78
Using the remote to play Radio recordings	80
Changing Radio Settings	81
<b>Chapter Nine: Using Other Features</b>	<b>83</b>
Changing Windows XP Media Center Settings	84
Using More Programs	85
Using Online Spotlight	86



<b>Chapter Ten: Getting Help</b>	<b>87</b>
Media Center FAQs	88
Wireless keyboard and mouse troubleshooting	91
Getting more help	93
Using Help and Support	94
Other Family Media Center resources	95
Documentation	95
Windows Update	95
Web site	95
Contacting Gateway	96
<b>Appendix A: Safety, Regulatory, and Legal Information</b>	<b>103</b>



# Setting Up Family Room Media Center

- Plan your Family Media Center setup
- Set up hardware and software

# About your Family Media Center

The Family Media Center provides rich entertainment and powerful computing capabilities. You can run the Windows XP Media Center while using other programs or just enjoy the Windows XP Media Center in full-screen mode without using other programs.

Use the Family Media Center remote the same way you use remotes for other home entertainment systems. You can use the remote and Family Media Center to watch and record TV, play videos and music, and view pictures.

Use the wireless keyboard and mouse to run Windows XP Media Center and other programs.





# Planning your Family Media Center setup

## Locating connections

You've probably already decided where you want to locate your Family Media Center, but before you start setting up the Media Center, take a few minutes to make sure that all of these connections are available in the location you've selected.

- ▶ **Internet connection** — Your Family Media Center needs an Internet connection to update the program guide and to access the Internet. Make sure that you have access to a dial-up or broadband Internet connection before starting your Media Center software setup. Contact your Internet service provider for more information about setting up your Internet connection.

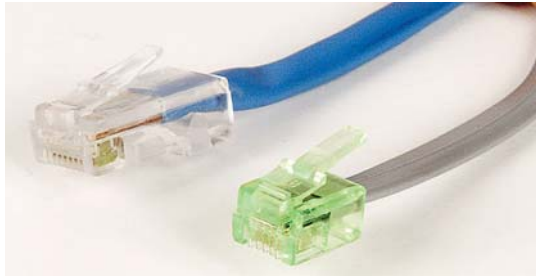

- ▶ **Video source** — Make sure that you have access to a video source before starting your Family Media Center setup. Your Media Center receives video input from a coaxial, composite video, or S-Video cable. The video source usually comes from an antenna, direct cable TV connection, cable box, or satellite receiver. Cable boxes and satellite receivers are also called *set-top boxes*.

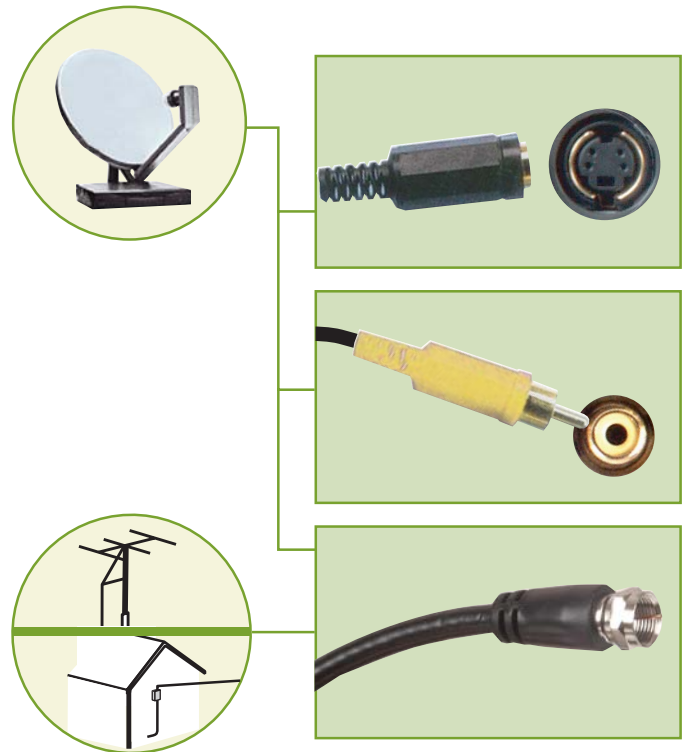

## Connections overview

Your Family Media Center accepts a variety of audio and video inputs and it can output audio and video to a number of audio and video devices. This is a sample setup diagram of a Media Center configuration. The possible audio and video input connections to your Family Media Center and the audio and video output connections from the Media Center are shown. For detailed information about setting up the Media Center, see "Setting up the hardware" on page 6.



### Connect to the Internet using:

- RJ-11 jack
- RJ-45 jack



### Caution:

Ventilation slots are located on the sides of your Family Media Center to allow for correct ventilation. To ensure reliable operation and to protect your Media Center from overheating, make sure that the ventilation slots are not blocked and that there is space around the ventilation slots for air circulation.



### Connect to an audio device using:

- 1/8" Digital Out jack
- 1/8" Analog Out jacks (front, rear, subwoofer/center speakers)
- Toslink Digital Out jack





**Connect to your Family Media Center using:**

- Cable set-top box (S-Video, composite, or coaxial connection)
- Satellite receiver set-top box (S-Video, composite, or coaxial connection)
- Antenna (coaxial connection)

**Connect to a display device using:**

- DVI-D Out jack
- S-Video Out jack
- VGA Out port



# Setting up the hardware

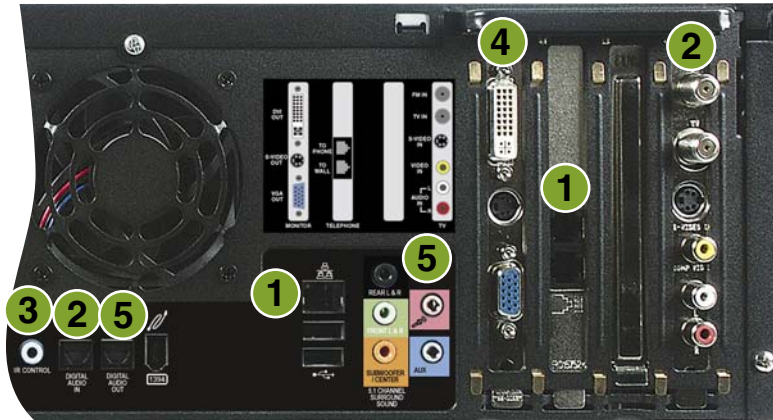

Gateway FMC-901 Media Center



Gateway FMC-901X Media Center

1 **Connect the modem or broadband Internet** (optional)



2 **Connect the audio/video source**

A **coaxial** (TV in) connection carries both the audio and video signals.

If you use an **S-Video** or a **Composite video** connection, you will also need to connect audio using RCA or Toslink stereo plugs.

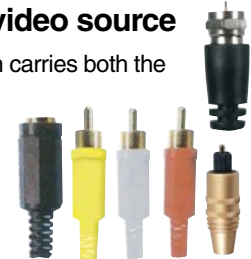

For detailed instructions about connecting the audio/video source, see page 12.

3 **Connect the IR control**

Plug one end of the IR control into your computer, then stick the other end to the set-top box sensor window.



remove the adhesive paper from the back of the IR control

For detailed instructions about connecting the IR control cable, see page 14.

4 **Connect to a display**

Connect to a monitor or television using a VGA, DVI, or television cable.

For detailed instructions about connecting to a display device, see page 15.

5 **Connect to an audio system**

For detailed instructions about connecting to an audio system, see page 17.

## 6 Install the mouse, keyboard, and remote batteries.



For more information, see “To install and charge the mouse battery pack” on page 8.



For more information, see “To install the keyboard batteries” on page 9.



## 7 Plug in your Media Center



## 8 Turn on your Media Center



Press the power button on the front of your Family Media Center.

## 9 Sync up wireless devices



keyboard

mouse

For more information, see “Synchronizing the wireless keyboard and mouse” on page 8.

# Setting up and synchronizing the wireless keyboard and mouse

Before using the wireless mouse and keyboard, install the batteries into both devices, connect the power adapter to the mouse charging cradle, charge the mouse for 9 hours before using, and synchronize the mouse and keyboard with the radio frequency (RF) receiver on your Family Media Center.

## To install and charge the mouse battery pack

- 1 Press the battery release button on the end of the mouse, then remove the battery pack and discard the plastic insulator tab.



- 2 Insert the battery pack back into the battery compartment.



- 3 Connect the power adapter to the mouse charging cradle, then plug the power adapter into the power outlet.



- 4 Place the mouse in the charging cradle. The cradle's LED indicator light, located at the bottom of the cradle, turns solid green and the mouse LED indicator will faintly flash green while the batteries are charging.



The mouse LED indicator lights continuously when it is fully charged and ready to use.

**+** **Tip:** When the battery drops to 20% of its full charge, the mouse LED indicator blinks intermittently while in use. To optimize the NiMH battery, recharge it at the end of each day's use.

**+** **Tip:** To conserve power, the mouse enters a "sleep mode" when it is left on and not used for more than 24 hours. Click any mouse button to wake the mouse from "sleep mode."

**+** **Tip:** If you do not need a fully charged battery for extended use, you can remove the mouse from the charging cradle at anytime. You do not need to wait for the mouse's LED indicator light to stop flashing.



### Tip:

The keyboard cover may be attached to the back of the keyboard when you receive it. Remove the keyboard cover from the back of the keyboard, as shown below, to access the battery compartment cover.

To protect the keyboard when not in use, you can place the keyboard cover over the keyboard keys.

## To install the keyboard batteries

- 1 Press the keyboard cover tabs down to remove the keyboard cover from the back of the keyboard.



- 2 Remove the battery compartment cover.

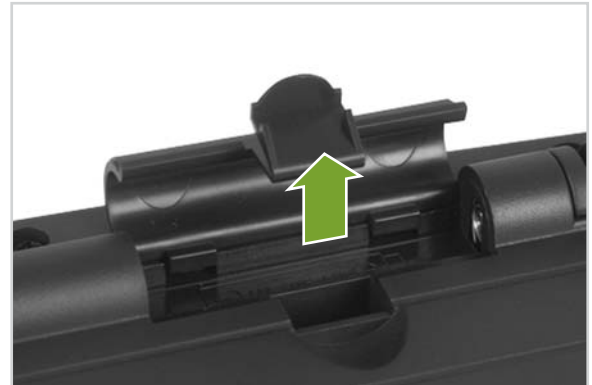

- 3 Insert 4 AAA batteries into the battery compartment. Make sure that you match the + and - on the batteries with the + and - symbols inside the battery compartment.



- 4 Replace the battery compartment cover and keyboard cover.



### Tip:

When synchronizing the wireless keyboard and mouse, make sure that you synchronize (teach) both the keyboard and mouse during the same Learning mode session. If you synchronize one wireless device and later enter the Learn mode to synchronize the other wireless device, the Learn mode erases all previous learned settings from memory and looks for new devices.

After the Teach/Learn sequence is complete, the receiver, keyboard, and mouse remain synchronized after turning off your Family Media Center or changing the channels the devices operate on. You only have to perform the Teach/Learn sequence when the devices are first installed or when adding additional devices to the system. For more information about changing the mouse or keyboard channels, see “Changing the keyboard or mouse channels” on page 34.

## To synchronize the wireless mouse and keyboard

- 1 Before synchronizing the mouse and keyboard, make sure that the batteries are installed in the keyboard and the battery pack is fully charged and installed in the mouse. For more information, see “Setting up and synchronizing the wireless keyboard and mouse” on page 8.

- 2 Press and hold the **Learn** button on your Family Media Center for 2 seconds then release the button. The *Status light* on the Family Media Center's front panel blinks slowly to indicate the receiver is in the *Learn mode*.



Learn button



- 3 Press and release the **Teach** button located on the bottom of the mouse. The *Status light* on the Family Media Center's front panel blinks rapidly for four seconds, then begins blinking slowly.



- 5 To exit the Learn mode, press the **Learn** button on your Family Media Center for two seconds. If you do not exit the Learn mode, it will automatically time out after five minutes.

- 4 Press and release the **Teach** button on the top left corner of the wireless keyboard.



# Connecting the audio and video source

Your Family Media Center has connectors for coaxial (TV), S-Video, or composite video. Select the connector that your video source supports:

- **Coaxial (TV)** — The video and audio signals are both carried on one cable. The coaxial cable is the way to connect a direct cable or an antenna video source to your Media Center.
- **S-Video or composite video** — S-Video signals provide the sharpest picture. Alternatively, you can use composite video for a slightly less sharp (but better than coaxial) video signal. If you use S-Video or composite video, you also need to connect the audio source using RCA stereo plugs.



## Tip:

The quality of the video coming into your Family Media Center determines the quality of the video output to your Media Center display device. A direct cable connection, cable set-top box, or satellite set-top box usually provides a better quality signal than an antenna. Use the highest quality video source available for best video display results.

The quality of cable used to connect the video source to your Media Center has an affect on the video output quality from your Media Center. Use high quality video cables to connect the video source to your Media Center.



## Caution:

If the video devices connected to your Media Center are not grounded correctly, your Media Center could be damaged. For more information about correct grounding, see the safety and regulatory information on page 103.

## To connect coaxial (TV)

- Connect a coaxial cable (not included) from a video device, such as a direct cable connection, a cable set-top box, or an antenna, to the Coaxial In (TV) port on the back of your Media Center.

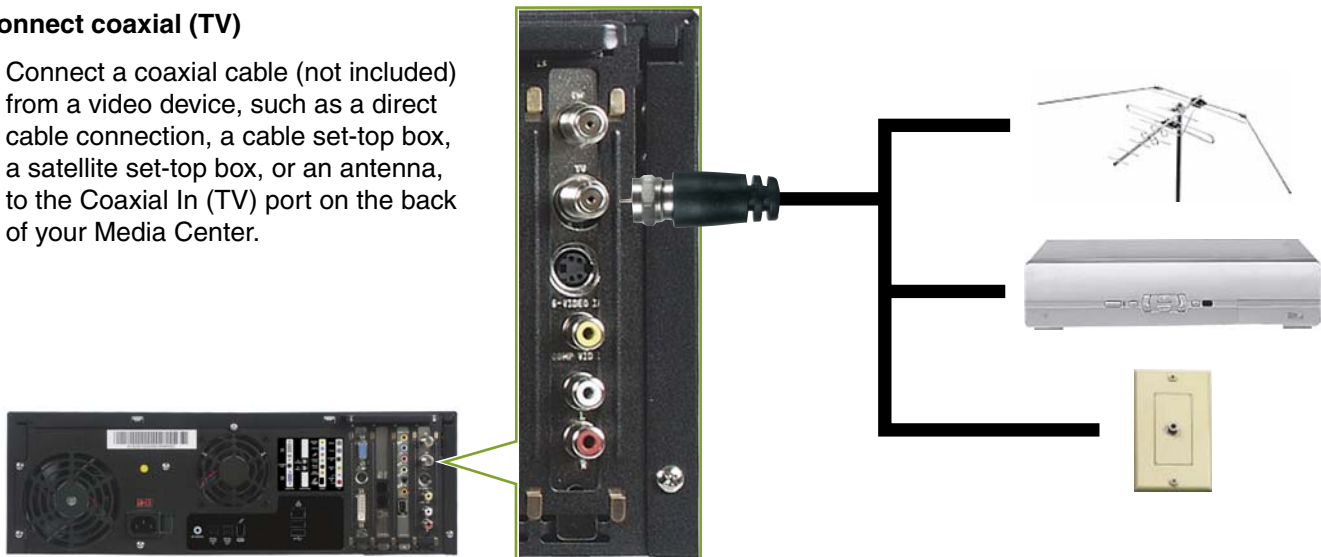

## To connect S-Video or composite video

- 1 Connect an S-Video or composite video cable from a video source (such as a cable set-top box, a satellite set-top box, or other video device) to the S-Video In or Composite Video In port on the back of your Family Media Center.

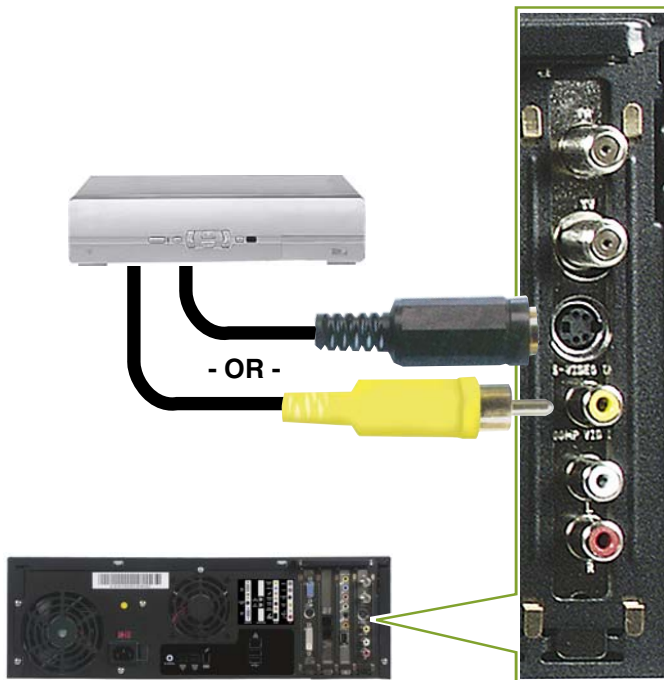

- 2 Connect an RCA cable (not included) from the Audio Out jacks on the video device to the Audio In RCA jack on the back of your Media Center.

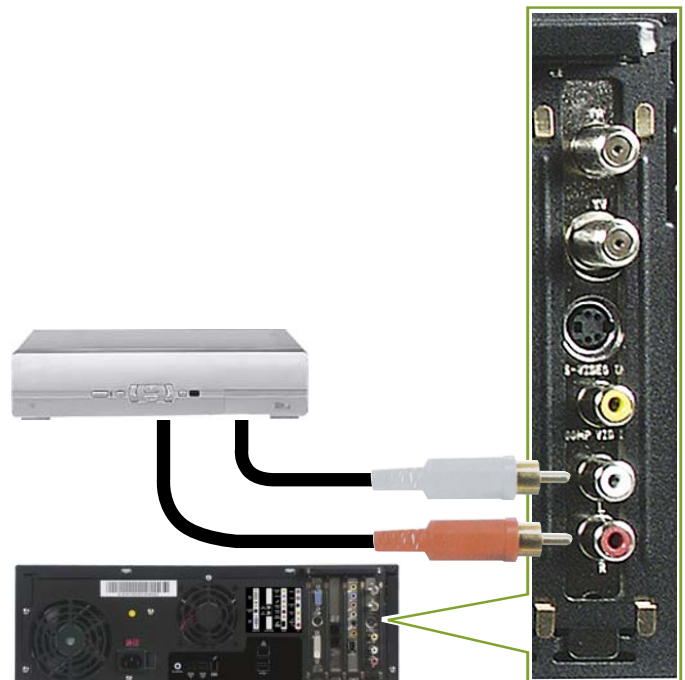

# Connecting the IR control cable

If your Family Media Center configuration uses a set-top box for the Media Center video source, connect the infrared (IR) control cable from the Family Media Center to the set-top box IR sensor window. The IR control cable sends input from the remote sensor to your set-top box to change channels.

## To connect the IR control cable

- 1 Plug the IR control cable into the IR control port on the back of your Family Media Center.



- 2 Locate the IR sensor by shining a flashlight through the set-top box IR sensor window. Look for a 1/2 to 3/8 inch metallic rectangle with a 1/8 inch dark circle in the middle. This is the IR sensor.



- 3 Remove the adhesive paper from the back of the IR control.



- 4 Place the sticky side of the IR control on the set-top box sensor window. Make sure that the IR control is placed directly in front of the IR sensor that you located in step 2.



**+** **Tip:** The Family Media Center IR control cable sends infrared signals to your set-top box or satellite receiver. However, some set-top boxes are set to receive radio frequency (RF) signals from the remote. Before using the Family Media Center remote, make sure that the set-top box is set to accept infrared signals. See your set-top box guide for information about remote settings.

# Connecting a display device

You can use a computer monitor, flat-panel display, TV, or other display device. Some older TVs provide a lower quality display than computer monitors or flat-panel displays that are optimized for your Family Media Center.

Your Media Center provides display outputs from a DVI (Digital Visual Interface) port, VGA (monitor) port, or an S-Video port. Select the highest quality port that your TV supports:

- **DVI** — Best. Use this if your TV has a DVI port.
- **VGA** — Better. If your TV does not have a DVI port but has a VGA port, use this.
- **S-Video** — Good. S-Video display quality is usually good for TV images. The display quality for the Media Center computer functions, however, is not as good as DVI or VGA output. S-Video display output is not optimized for computer video display.

If you did not purchase a display device when you purchased your Media Center and your video display does not provide the image quality that you expected, contact a Gateway sales representative to help you select a display device that is optimized for your Media Center. See “Contacting Gateway” on page 96 for Gateway contact information.



## Tip:

Many TVs use *interlaced video*. Interlaced video displays a video frame with two passes of alternating scan lines. The TV screen first displays the video image odd lines one at a time, sequentially from top to bottom, then it fills in the other half of the video image with the even lines. Because most TVs use this interlaced method to display the picture on the screen, a standard interlaced analog television will most likely flicker when displaying thin lines and small text. An interlaced video display device will produce a lower quality display, especially when viewing and using the Family Media Center computer functions.

*Progressive scan* video displays a video frame with one pass of sequential scan lines. A progressive scan TV displays the entire picture, drawn sequentially from top to bottom, without the odd/even interlacing. This results in a fuller, sharper picture, and better display quality for viewing and using the Family Media Center computer functions. The progressive scan picture is also brighter and easier on your eyes.



## Tip:

If you want the audio to play from the external TV that you connected to, connect the Audio out jacks (analog or digital) to your TV Audio in jacks. If you do not connect the Audio out jacks to your TV, the sound will continue to play from your Family Media Center and other sound system connected to your Media Center.



## Help:

By default, if your display device was purchased with your Family Media Center computer, the computer uses a screen resolution of 1024 x 768 for computer monitors. Many TVs cannot display this high resolution and may shift, scramble, or scroll the picture. For a better picture on a TV display, you may need to lower the Family Media Center screen resolution to 800 x 600 or 640 x 480. For more information about adjusting display settings, click **Start**, then click **Help and Support**. Type the keyword *changing display settings* in the Search box, then press **Enter**.

## To connect a display device

- 1 Connect a VGA cable (not included), S-Video cable, or DVI cable (not included) to the VGA port, S-Video port, or DVI port on the back of your Family Media Center.

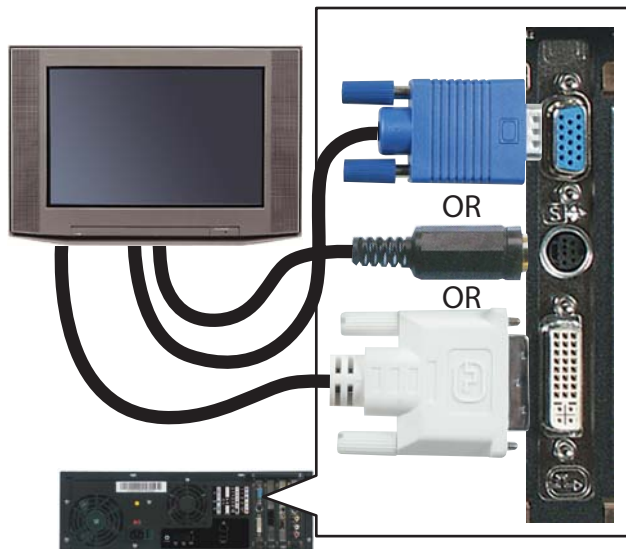

- 2 Connect the other end of the cable to the VGA port, S-Video port, or DVI port on the back of your TV.

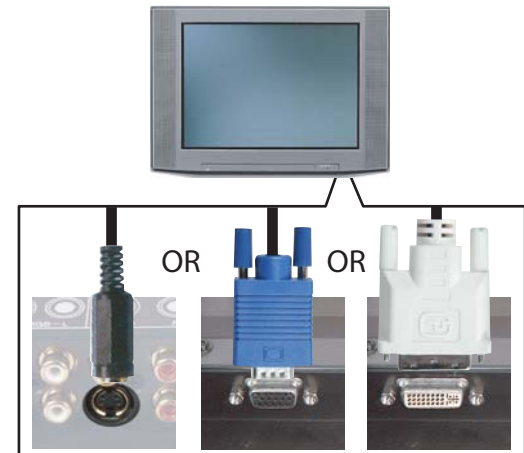

- 3 Turn the TV on and select the TV In video source. For more information about selecting the TV In video source, see your TV's documentation.

# Connecting an audio system

If you purchased a sound system with your Family Media Center, use the setup poster and other documentation that was included with the sound system to set it up.

If you have an existing stereo or home theater, you can connect your Media Center to an existing sound system. Use:

- **1/8" stereo to RCA plug Y-cables** to connect the Family Media Center to an analog sound system.
- **1/8" stereo to 1/8" stereo plug** to connect the Family Media Center to digital audio inputs (S/PDIF).
- **Toslink digital cable** to connect your Family Media Center to digital audio inputs (S/PDIF).

Gateway FMC-901 Media Center

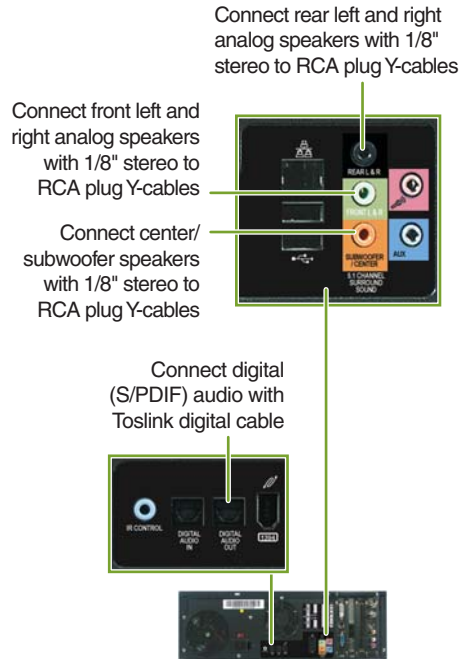

Gateway FMC-901X Media Center

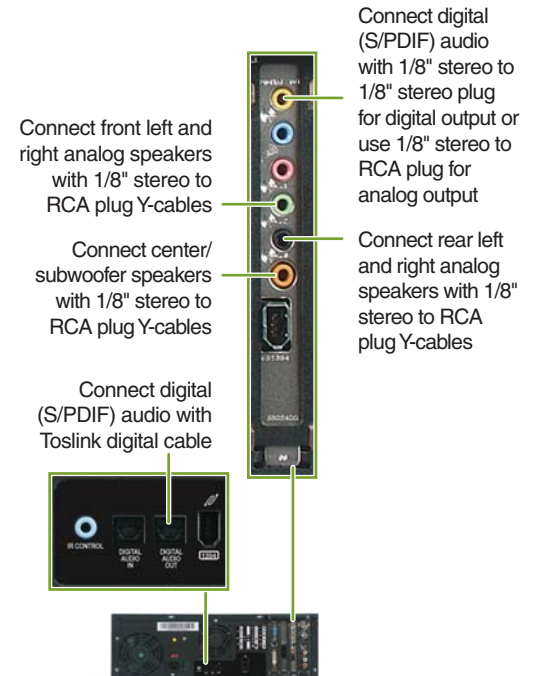

**+** **Tip:** The audio system setup varies, depending on your sound system audio inputs. See your sound system's user guide for more information about connecting audio inputs.

After you have connected your add-on sound system, use the sound and audio properties to select speaker setup options.

### To select speaker options in XP Media Center 2004

- 1 Click **Start, Control Panel, Sounds, Speech, and Audio Devices**, then click **Sounds and Audio Devices**. The *Sounds and Audio Devices Properties* dialog box opens.
- 2 Click the **Volume** tab, then click the **Advanced** button in the Speaker Settings section. The *Advanced Audio Properties* dialog box opens.

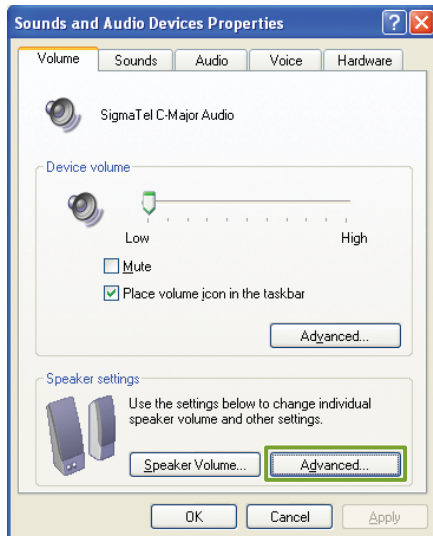

- 3 Click the **Speakers** tab, click the arrow button to open the **Speaker setup** list, then click the speaker setup that most closely matches your sound system type.

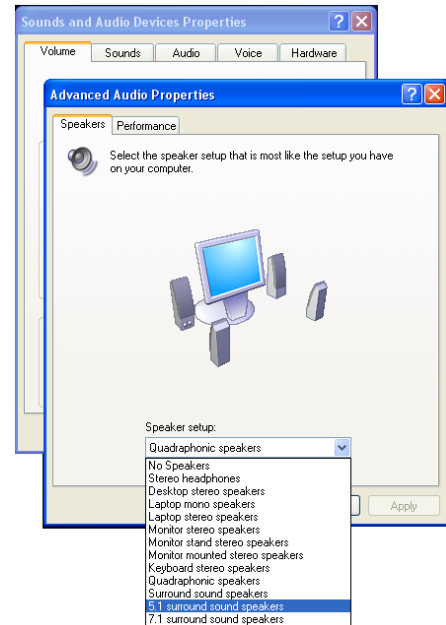

- 4 Click **OK** to save your speaker setup.



#### Tip:

If you have a Gateway FMC-901 Family Media Center model, you can also configure audio inputs with the SigmaTel audio Speaker Wizard and *SigmaTel Universal Jacks* dialog box. Click **Start, All Programs, SigmaTel**, then click one of the SigmaTel programs.



# Setting up the software

## 1 Complete the Windows XP setup

After you've turned on your Family Media Center, wait for it to start up, then follow the on-screen instructions.



## 2 Complete external devices setup

Connect devices, such as a printer or scanner, after you complete the Windows setup. Follow the instructions that came with the device.

## 3 Start the Windows XP Media Center setup wizard

After you've completed the initial Windows setup, press the Start button on your remote.



### Tip:

The Windows XP Media Center setup wizard requires Internet access to complete the Windows XP Media Center software configuration. Before starting the Windows XP Media Center setup wizard in step 3, make sure that your Internet connection is set up. Contact your Internet service provider for more information about setting up your Internet connection.

Before starting the Windows XP Media Center setup wizard, check for Windows Updates to make sure that Windows XP Media Center has the most recent software releases and security updates installed. For more information, see "Windows Update" on page 95.

## 4 Configure the Windows XP Media Center software for your specific requirements

Follow the on-screen instructions.





A photograph of a man and a young boy looking at something together on a grassy field. The man is leaning over the boy, and they both appear to be focused on a task. The background is a bright, green lawn.

# Getting Started



- Learn about your Gateway 901 Series Family Media Center
- Learn about the remote
- Learn about the wireless keyboard and mouse
- Start the Windows XP Media Center
- Use your Family Media Center





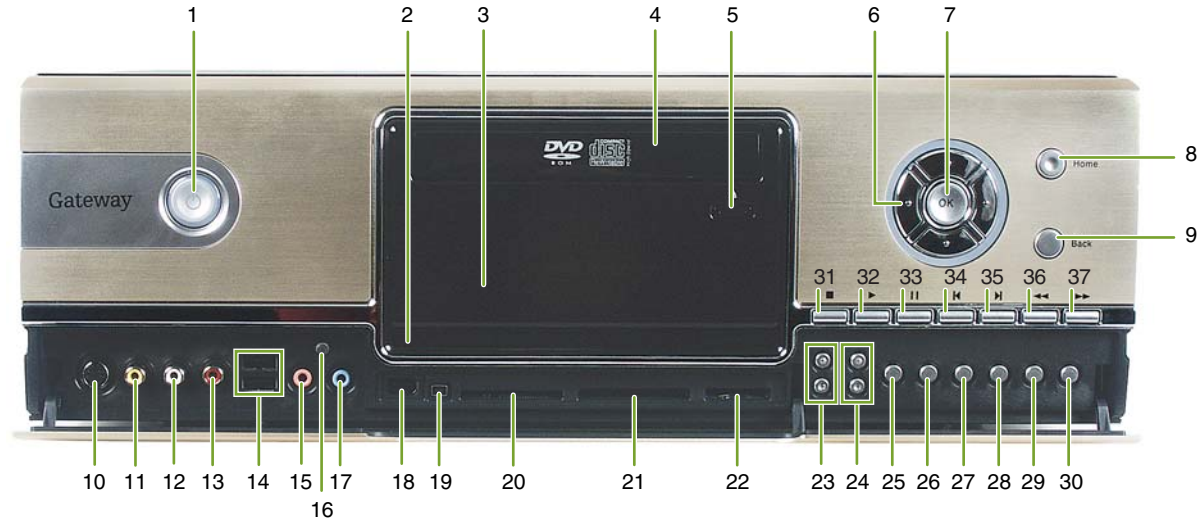

## Chapter Two

# Checking out your Family Media Center

## Front







Item	Component	Icon	Description
1	Power button		Press to turn the power on. Press to put the Family Media Center in Standby mode or resume from Standby mode.
2	Hard drive / card reader indicator		LED blinks on and off as data is read from and written to the hard drive or memory card.
3	Status display		Indicates the current Media Center mode and status.
4	(FMC-901) DVD/CD-RW combo drive (FMC-901X) DVD RAM/-R/CDRW		Use this drive to listen to audio CDs, install games and programs, watch DVDs, and store large files onto recordable CDs and DVDs (recordable DVD is optional)

Item	Component	Icon	Description
5	DVD/CD drive eject button		Press to open the CD/DVD tray.
6	Four-way scroll button		Press the up ▲, down ▼, left ◀, or right ▶ buttons to move the pointer around the Guide and menus.
7	OK button		Press to make menu selections.
8	Home		Press to navigate to the browser's default home page.
9	Back		Press to navigate to the previous browser page.
10	S-Video In port		Plug an S-Video cable from a video source, such as a camcorder or VCR into this port.
11	Video In port (RCA)		Plug an RCA cable from a video source, such as a VCR, into this port.
12	Audio In jack (Left RCA)		Plug the left channel external audio input source, such as a stereo or camcorder, to this jack so you can play sound through the Family Media Center speakers or record sound on your Family Media Center.
13	Audio In jack (Right RCA)		Plug the right channel external audio input source, such as a stereo or camcorder, to this jack so you can play sound through the Family Media Center speakers or record sound on your Family Media Center.
14	USB ports (2)	USB v2.0 	Plug USB (Universal Serial Bus) devices, such as a USB printer, scanner, camera, keyboard, or mouse, into these ports.
15	Headphone jack		Plug amplified speakers or headphones into this jack.
16	Learn		Press to put the Family Media Center into a "learn" mode to synchronize with the mouse and keyboard. For more information, see "Setting up and synchronizing the wireless keyboard and mouse" on page 8.
17	Mic-In jack		Plug an external microphone to record or transmit voice input.
18	IEEE 1394 ports		Plug an IEEE 1394 (also known as Firewire® or i.Link®) device, such as a digital camcorder, into the 6-pin IEEE 1394 port.
19	IEEE 1394 ports		Plug an IEEE 1394 (also known as Firewire or i.Link) device, such as a digital camcorder, into the 4-pin IEEE 1394 port.

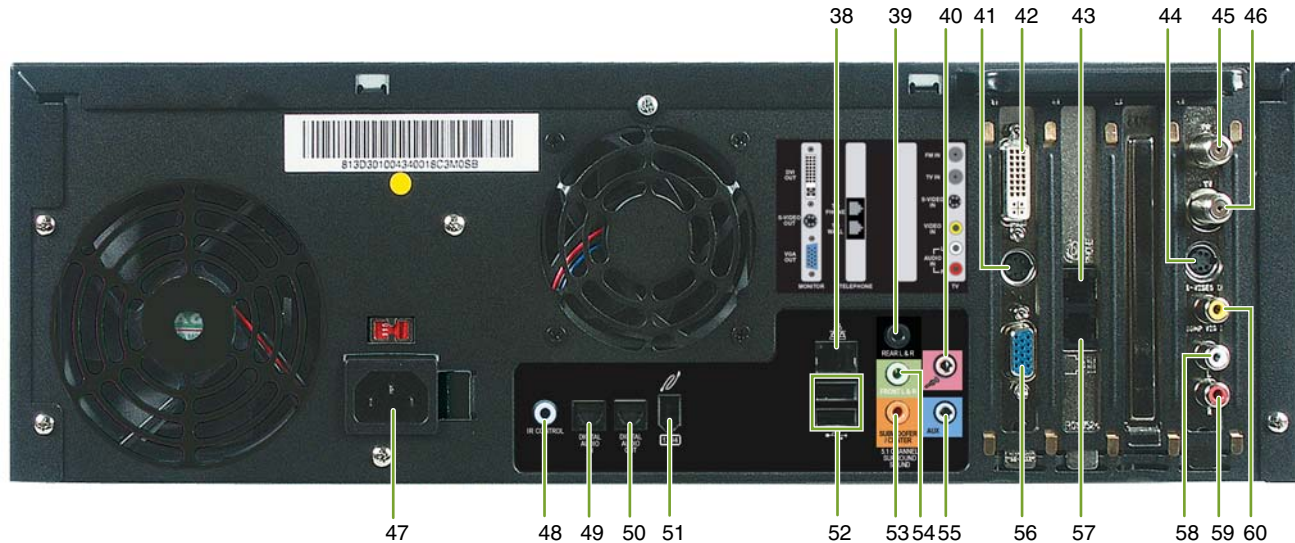
Item	Component	Icon	Description
20	SmartMedia	SM	Transfer files from a digital device to your Media Center through the removable memory card drive.
21	CompactFlash	CF	Transfer files from a digital device to your Media Center through the removable memory card drive.
22	SecureDigital Memory Stick Memory Stick Pro MultiMedia Card	SD MS MS Pro MMC	Transfer files from a digital device to your Media Center through the removable memory card drive.
23	Volume + / - button		Press to increase and decrease the volume level.
24	Channel + / - button		Press to change the channel sequentially to a lower or higher channel number.
25	My TV button		Press to open the Media Center My TV feature.
26	DVD Menu button		Press to open the Media Center DVD player.
27	My Music button		Press to open the Media Center My Music feature.
28	My Pictures button		Press to open the Media Center My Pictures feature.
29	My Videos button		Press to open the Media Center My Videos feature.
30	Radio button		Press to open the Media Center My Radio feature.
31	Stop button		Press to stop the currently playing media. For example, stop Live TV, recorded TV, and CD or DVD media.
32	Play button		Press to play the selected media. For example, Live TV (that is buffered), recorded TV, and CD or DVD media.
33	Pause button		Press to pause the currently playing media. For example, pause Live TV, recorded TV, and CD or DVD media.
34	Replay button		Press to replay the currently playing media in 7 second increments. For example review the previous 7 seconds of Live TV, recorded TV, and CD or DVD media.
35	Skip button		Press to fast-forward the currently playing media in 7 second increments. For example review the previous 7 seconds of Live TV, recorded TV, and CD or DVD.
36	Rewind button		Press to rewind the currently playing media. For example, rewind Live TV (that is buffered), recorded TV, and CD or DVD media
37	Forward button		Press to fast-forward the currently playing media. For example, fast-forward Live TV (that is buffered), recorded TV, and CD or DVD media.

# Back (Gateway FMC-901 Media Center)







Item	Component	Icon	Description
38	Ethernet jack		Plug 10/100 Ethernet network cable into this jack. For more information about networking, see the <i>Networking Your Computer</i> guide. Click <b>Start, All Programs, Gateway Documentation</b> , then click the networking guide.
39	Rear left and right Analog Audio Out jack (line out)		Plug powered, analog rear speakers or an external amplifier into this jack. Use a 1/8" stereo to RCA plug Y-cable.
40	Mic-In (microphone jack)		Plug a microphone into this jack to record or transmit voice input.
41	S-Video Out port		Plug a video device, such as a monitor or a camcorder, that support S-Video into this port.
42	DVI-D Out port		Plug a digital DVI-D display device, such as a plasma display, into this port.
43	To Phone jack		Plug the telephone into this port.
44	S-Video In port		Plug an S-Video cable from a video source, such as cable, satellite, or antenna, into this port.
45	FM In antenna (external coaxial connector)		Plug an external FM antenna into this port.

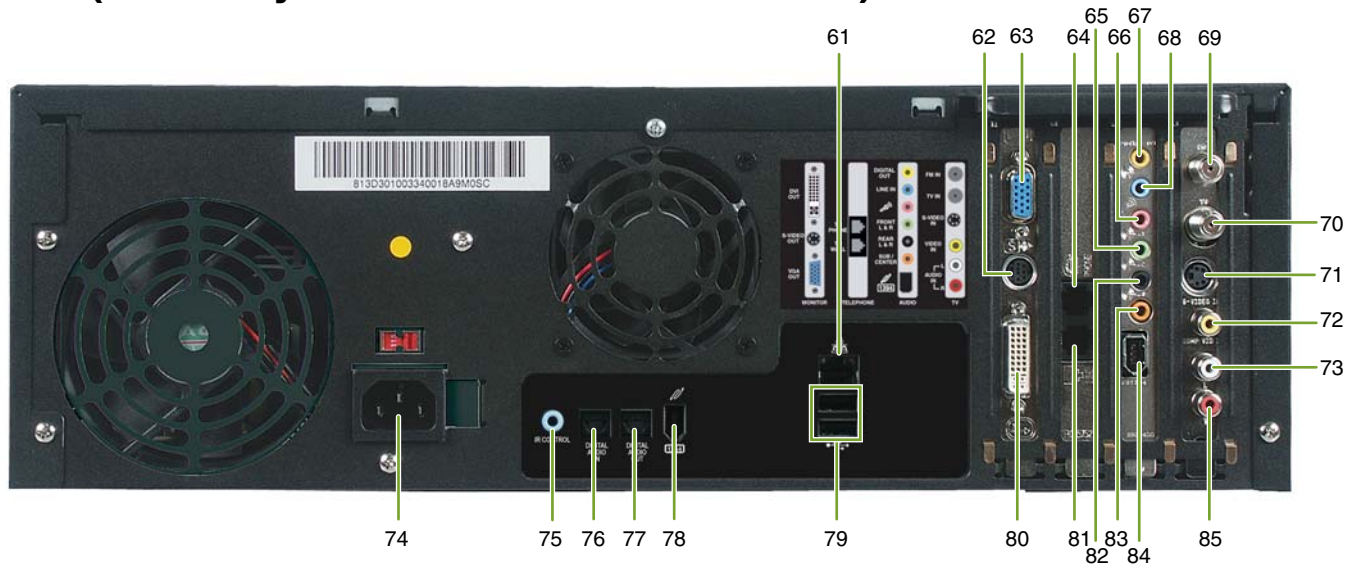

Item	Component	Icon	Description
46	TV In jack (coaxial)		Plug a coaxial cable from a video source, such as cable, satellite, or antenna, into this jack.
47	Power connector		Plug the AC adapter cable into this connector.
48	IR Control port		Plug the IR control cable into this port. Sends input from the keyboard or remote to a set-top box to change channels.
49	Digital Audio In (S/PDIF) jack		Plug an optical (Toslink) digital audio cable from an audio source into this jack.
50	Digital Audio Out (S/PDIF) jack		Plug an optical (Toslink) digital audio cable from this jack into a digital audio device.
51	IEEE 1394 port		Plug an IEEE 1394 (also known as Firewire or i.Link) device, such as a digital camcorder, into this 6-pin IEEE 1394 port.
52	USB ports (2)	USB v2.0 	Plug USB (Universal Serial Bus) devices, such as a USB printer, scanner, camera, keyboard, or mouse, into these ports.
53	Subwoofer/Center Analog Audio Out jack (line out)		Plug powered, center/subwoofer speakers or an external audio amplifier into this jack. Use a 1/8" stereo to RCA plug Y-cable.
54	Front left and right Analog Audio Out jack (line out)		Plug powered, analog front speakers, an external audio amplifier, or headphones into this jack. Use a 1/8" stereo to RCA plug Y-cable.
55	AUX (audio input jack)		Plug an external audio input source, such as a stereo or camcorder, into this jack so you can play sound through the Media Center speakers or record sound on your Media Center.
56	VGA Out (monitor port)		Plug an analog VGA monitor into this port.
57	To Wall (modem In jack)		Plug an RJ-11 modem cable into this jack.
58	Audio In jack (left channel)		Plug an RCA cable from a left channel audio out jack, such as cable, satellite, or antenna, into this jack.
59	Audio In jack (right channel)		Plug an RCA cable from a right channel audio out jack, such as cable, satellite, or antenna, into this jack.
60	Video In jack (RCA)		Plug an RCA cable from a video source, such as a VCR, into this jack.







# Back (Gateway FMC-901X Media Center)



Item	Component	Icon	Description
61	Ethernet jack		Plug 10/100 Ethernet network cable into this jack. For more information about networking, see the "Networking Your Computer" guide. Click <b>Start, All Programs, Gateway Documentation</b> , then click the networking guide.
62	S-Video Out port		Plug a video device, such as a monitor or camcorder, that support S-Video into this port.
63	VGA Out (monitor port)		Plug an analog VGA monitor into this port.
64	To Phone jack		Plug the telephone into this jack.
65	Front left and right Analog Audio Out jack (Green jack)		Plug powered, analog front speakers, or an external audio amplifier into this jack. Use a 1/8" stereo to RCA plug Y-cable. Also supports headphones.
66	Mic-In (microphone jack) (Pink jack)		Plug an external microphone to record or transmit voice input.

Item	Component	Icon	Description
67	Digital Out jack (line out) (Yellow jack)	Digital Out	Plug an audio system into this jack. Provides six-channel or compressed AC-3 digital output (S/PDIF) for connection to external digital devices and speakers. Also supports center and subwoofer (LFE) analog channels for connection to 5.1 analog speaker systems. Use a 1/8" stereo to 1/8" stereo plug for digital output or use 1/8" stereo to RCA plug for analog output.
68	Line in (Analog In jack) (Blue jack)		Plug an external audio input source, such as a stereo, into this jack so you can record sound on your Media Center or play sound through the external speakers.
69	FM In antenna (external coaxial connector)		Plug an external FM antenna into this port.
70	TV In jack (coaxial)		Plug a coaxial cable from a video source, such as cable, satellite, or antenna, into this jack.
71	S-Video In port		Plug an S-Video cable from a video source, such as cable, satellite, or antenna, into this port.
72	Video In port (RCA)		Plug an RCA cable from a video source, such as a VCR, into this port.
73	Audio In jack (left channel)		Plug an RCA cable from a left channel audio out jack, such as cable, satellite, or antenna, into this jack.
74	Power connector		Plug the AC adapter cable into this connector. IR control cable into this port.
75	IR Control port		Plug the IR control cable into this port. Sends input from the keyboard or remote to a set-top box to change channels.
76	Digital Audio In (S/PDIF) jack		Plug an optical (Toslink) digital audio cable from an audio source into this jack.
77	Digital Audio Out (S/PDIF) jack		Plug an optical (Toslink) digital audio cable from this jack into a digital audio device.
78	IEEE 1394 port		Plug an IEEE 1394 (also known as Firewire or i.Link) device, such as a digital camcorder, into this 6-pin IEEE 1394 port.
79	USB ports (2)	USB v2.0 	Plug USB (Universal Serial Bus) devices (such as a USB printer, scanner, camera, keyboard, or mouse) into these ports.

Item	Component	Icon	Description
80	DVI-D Out jack		Plug a digital DVI-D display device, such as plasma display, into this port.
81	To Wall (modem In jack)		Plug an RJ-11 modem cable into this jack.
82	Rear left and right Analog Audio Out jack (Black port)		Plug powered, analog rear speakers or an external amplifier into this jack. Use a 1/8" stereo to RCA plug Y-cable.
83	Subwoofer/Center Analog Audio Out jack (Orange port)		Plug powered, center/subwoofer speakers or an external audio amplifier into this jack. Use a 1/8" stereo to RCA plug Y-cable.
84	IEEE 1394 port		Plug an IEEE 1394 (also known as Firewire or i.Link) device, such as a digital camcorder, into this 6-pin IEEE 1394 port.
85	Audio In jack (right channel)		Plug an RCA cable from a right channel audio out jack, such as cable, satellite, or antenna, into this jack.

# Learning about the remote

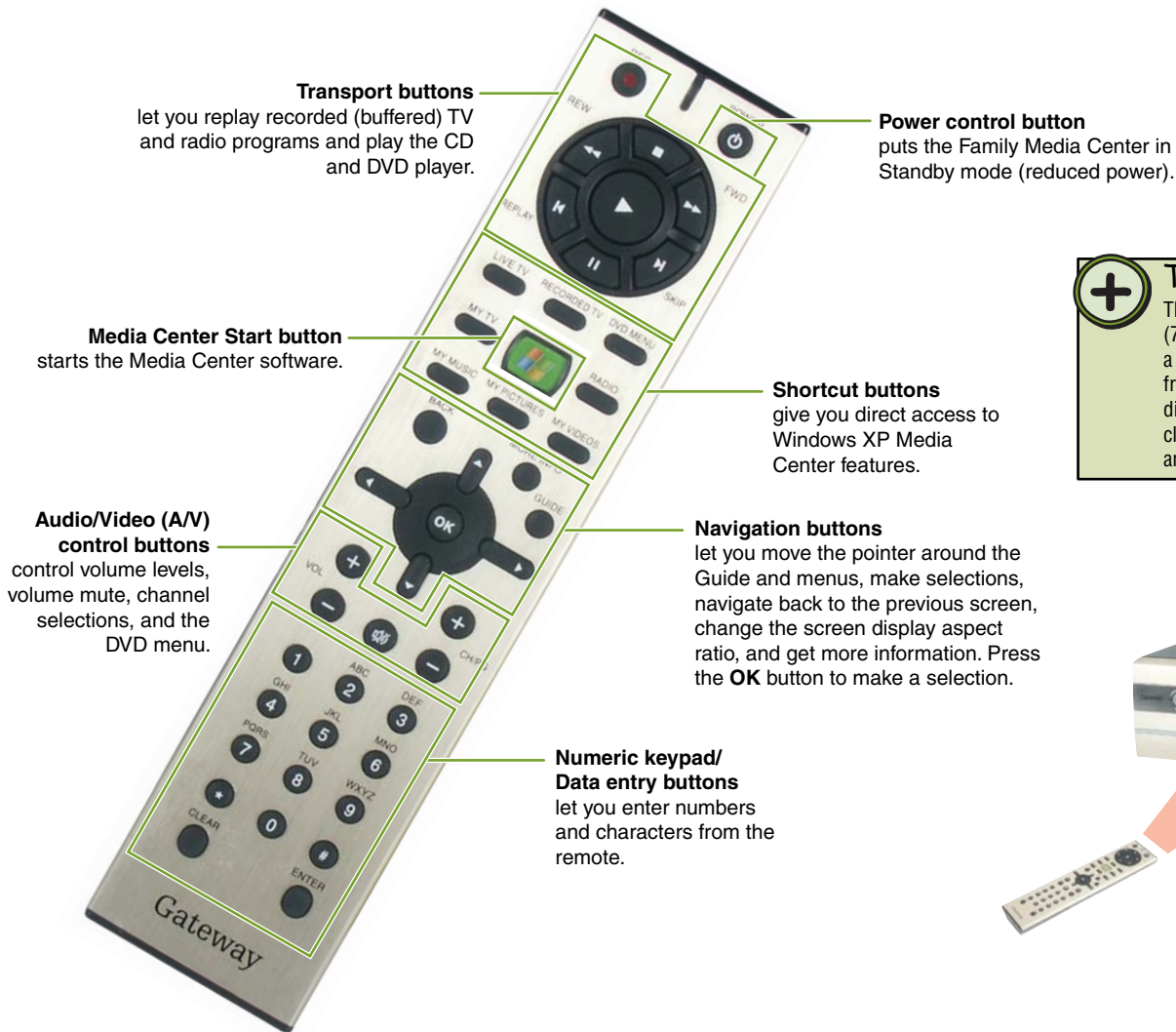

**+** **Tip:**  
The remote has a range of 23 feet (7.5 meters) and performs best with a maximum angle of 22.5 degrees from the center of the IR receiver in all directions. Make sure that there is a clear line of sight between the remote and the IR receiver.



# Using the remote

Use the Media Center remote to watch TV, videos, and DVDs, to listen to music, and to view pictures.

Use the remote *navigation buttons* to highlight a Windows XP Media Center menu option, then press the **OK** button to select the menu option.

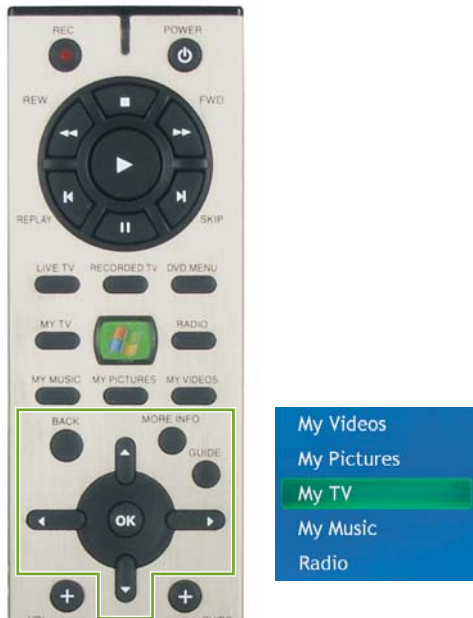

- OR -

Press one of the menu *shortcut buttons* on the remote for direct access to a Windows XP Media Center menu.

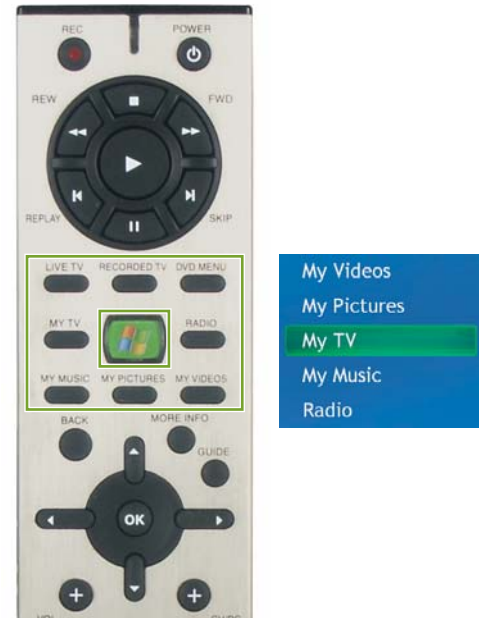

# Learning about the wireless mouse

## Status LED indicator

indicates mouse status. See "Media Center FAQs" on page 88.

## Battery pack

install rechargeable battery pack

## Scroll wheel and button

use to move vertically through a document or program.

## Left/Right select buttons

use to select objects and menus on the screen.



## Activation trigger

lets you make mouse selections while using the mouse in the air.

## Channel button

use to change the radio frequency (RF) channel the mouse uses. For more information, see "Changing the wireless keyboard or mouse channels" on page 34.

## Teach button

use to synchronize the mouse with the radio frequency (RF) receiver. For more information, see "Setting up and synchronizing the wireless keyboard and mouse" on page 8.



## Battery release button

press to open the battery pack compartment.



## Activation trigger

lets you make mouse selections while using the mouse in the air.

# Using the wireless mouse

The wireless mouse gives you flexibility to control your Family Media Center. The mouse provides precise tracking on most surfaces. You can also use the mouse in the air to point and select on the screen.



## Tips:

For optimal mouse performance, avoid using the mouse on highly reflective glass or mirrored surfaces.

For optimal battery life, avoid using the mouse on dark-colored surfaces.

## To use the wireless mouse on a flat surface

- 1 Before using the wireless mouse, set up and synchronize the mouse with the radio frequency (RF) receiver on your Family Media Center. For more information, see “Setting up and synchronizing the wireless keyboard and mouse” on page 8.
- 2 Remove the mouse from the charging cradle and place it on a flat surface. The LED light on the Family Media Center flickers rapidly when the mouse communicates with the RF receiver.
- 3 Use the mouse like a standard desktop mouse.



## To use the wireless mouse in the air

- 1 Before using the wireless mouse, set up and synchronize the mouse with the radio frequency (RF) receiver on your Family Media Center. For more information, see “Setting up and synchronizing the wireless keyboard and mouse” on page 8.
- 2 Hold the mouse in a comfortable, relaxed position:
  - Put your index finger on the activation trigger and your thumb at the base of the scroll wheel.
  - Press and hold the activation trigger with your index finger. While holding the trigger, flex your wrist up, down, and sideways (in a manner similar to using a flashlight). The mouse pointer tracks the motions of your hand.



## Tips:

Double-click the activation trigger to keep the pointer continuously active. To stop the pointer movement, click the activation trigger again.

Move the pointer over a target and release the activation trigger before clicking the left or right mouse buttons. This *parks* the pointer and lets you click more accurately.

- Use your thumb to press the left or right mouse button or operate the scroll wheel.



# Fine-tuning the wireless mouse pointer control

While getting familiar with your wireless mouse and getting a feel for the “in air” method of pointer control, you may want to adjust the mouse settings. You can adjust the double-click speed, pointer speed, left-hand or right-hand configuration, and other mouse settings. We recommend you adjust:

- **Pointer Speed to Average.** Some new users prefer this setting to be slightly slower than average. Advanced users tend to increase the speed so that less wrist movement gives them more screen coverage with the pointer.
- **Acceleration to Low or Off.**

## To change the mouse settings

- 1 In Windows XP, click **Start**, then click **Control Panel**. The *Control Panel* window opens. If your Control Panel is in Category View, click **Printers and Other Hardware**.
- 2 Click/Double-click the **Mouse** icon. The *Mouse Properties* dialog box opens.
- 3 Click the **Advanced Features** tab, then click **Settings** to change your mouse settings.
- 4 To modify mouse settings, click the + in front of a setting, then modify the setting.

# Changing the wireless keyboard or mouse channels

When two wireless devices, such as the keyboard and mouse, are used in the same area, each device should be set to operate on a different channel. For best reception, space the channels apart by one or more channels. For example, set the channels to channel 2 and 4 rather than channel 2 and 3.



## Tips:

If the Teach/Learn sequence has already been performed, you do not need to re-synchronize the keyboard and mouse after a channel change.

## To change the wireless keyboard or mouse channel

- 1 Press and hold the *Channel* button on the bottom of the wireless keyboard or mouse for two seconds.
- 2 Release the Channel button. The keyboard or mouse changes to the next channel and the keyboard or mouse green LED (and the charging cradle's red LED) flashes. The number of flashes indicates the new channel the keyboard or mouse is using.



# Determining the wireless keyboard or mouse channels

The wireless keyboard and mouse have eight channels available to communicate on. Use the following instructions to determine the channel a device is currently using.

## To determine the wireless keyboard or mouse channel

- 1 Press and quickly release the *Channel* button on the bottom of the wireless keyboard or mouse.
- 2 Count the number of times the keyboard's or mouse's green LED (and the charging cradle's red LED) flashes. The number of flashes indicates the channel the keyboard or mouse is using.



### Tips:

If the keyboard's or mouse's channel is changed when the Media Center PC power is off, the devices will become unsynchronized. To re-synchronize the devices, click and quickly release the Channel button as described in the instructions above to confirm the keyboard's or mouse's channel. The keyboard or mouse broadcasts a message across all eight channels that tells the Family Media Center's receiver which channel the device is currently operating on. The receiver then automatically restores synchronization.

# Turning the wireless keyboard or mouse power on and off

Turn the wireless keyboard and mouse off to prevent battery drain when traveling or when you do not plan to use your Family Media Center for several days.



### Warning:

Radio frequency wireless communication can interfere with equipment on commercial aircraft. Current aviation regulations require wireless devices to be turned off while traveling in an airplane.

## To turn the wireless keyboard or mouse off

- Simultaneously press and release the *Channel* and *Teach* buttons on the bottom of the wireless keyboard or mouse. The keyboard or mouse turns off and will not respond to button clicks. The LED indicator flashes three times to confirm the device is turned off.

## To turn the wireless keyboard or mouse on

- Simultaneously press for three seconds, then release the *Channel* and *Teach* buttons on the bottom of the wireless keyboard or mouse. The keyboard or mouse turns on and will respond to button clicks. The LED indicator flashes for one second to confirm the device is turned on.







# Learning about the wireless keyboard

Use the keyboard to navigate and select the Windows XP Media Center menus and options and perform other activities such as typing an e-mail.

For information about changing the wireless keyboard channels, see “Changing the wireless keyboard or

mouse channels” on page 34. For information about determining the wireless keyboard channel, see “Determining the wireless keyboard or mouse channels” on page 35. For information about turning the wireless keyboard on or off, see “Turning the wireless keyboard or mouse power on or off” on page 35.



Item	Component	Icon	Description
1	Status LED indicator	Status	Indicates keyboard status. See "Media Center FAQs" on page 88.
2	Channel button		Use to change the radio frequency (RF) channel the keyboard uses. For more information, see "Changing the wireless keyboard or mouse channels" on page 34.
3	Teach button		Use to synchronize the keyboard with the radio frequency (RF) receiver. For more information, see "Setting up and synchronizing the wireless keyboard and mouse" on page 8.
4	Transport buttons		Lets you replay buffered TV programs and play the CD and DVD player.
5	Audio/Video (A/V) control buttons		Controls volume levels and volume mute.
6	Internet and e-mail buttons		Starts your Internet browser and e-mail program. Lets you navigate the Internet browser and search for information.
7	Windows keys		Gives you direct access to the Windows <b>Start</b> menu.
8	Application key		Lets you access shortcut menus and help assistants in Windows.
9	Directional (navigation) keys		Lets you move the pointer around the Guide and menus.

# Starting the Windows XP Media Center

You can take full control of the Family Media Center from your wireless keyboard, remote, and mouse. Use the device that is comfortable for you.

## To start Windows XP Media Center from the Start menu

- Click **Start**, then click **Media Center**.



## To start Windows XP Media Center with the remote



- Press the Start  button on the remote.



# Using the Windows XP Media Center

You can switch to the Microsoft Windows desktop at any time. Windows XP Media Center will continue to run in the background.

## To switch between the Windows XP Media Center and the desktop

- Click the minimize button to view the desktop. 
- Click the maximize button to expand the active window to fit the entire screen. 
- Click the Media Center taskbar button or press the Start  button on the keyboard or remote to return to the Media Center.



The Windows XP Media Center menu bar and transport controls toolbar appear when you move the mouse. Use the keyboard, remote, or mouse to make selections.





# Using MyTV

- Watch Live TV
- View the Guide and select TV programs
- Schedule, record, and sort TV program recordings
- Search for programs by categories, title, or keyword
- Change My TV settings

## Chapter Three

# Watching TV

You can control your TV viewing experience with My TV. Use My TV to watch TV, record TV, watch buffered (time-shifted) TV, watch recorded programs, search for programs, change TV settings, and more.

While watching My TV or using the Guide, you can press the **More Info** button on the remote to view more information about the selected program.

## To watch a TV program

- 1 On the remote, press the **My TV** button. The last viewed TV channel is displayed.



- 2 On the remote, press the **CH/PG +** or **CH/PG -** button to change channels, enter a channel on the remote's numeric keypad, select channels from the Guide, or search for a TV program by category, title, or keyword.

## To view a TV program in full-screen mode

- 1 With My TV on, navigate to highlight Live TV.



- 2 Press the **OK** button to maximize the TV viewing window to full-screen mode.

## To exit the full-screen mode

- With My TV in full-screen mode, press the remote's **Back** navigation button. The previous Windows XP Media Center screen is displayed.



### Help:

If you prefer, you can use the Family Media Center keyboard instead of the remote to control My TV. The arrow keys on your keyboard work as the navigation buttons. For other commands, use the keyboard shortcuts described in the Windows XP Media Center Help. To open the Windows XP Media Center Help, move the mouse to activate the menu bar, then click the Help button .



# Using the remote to play TV recordings

My TV automatically records TV programs to a program buffer as you watch TV. When you stop or pause live TV programs, My TV continues recording (buffering) the program for up to 30 minutes so you can watch the program where you previously left off. You can also

press the **Replay** button, while watching a program, to rewind and replay a segment of the program. Use the remote transport buttons or the transport controls toolbar (activated by moving the mouse), to control Live TV and recorded TV playback.

Remote button	Press:
Pause 	<b>Pause</b> to freeze the live TV image. While paused, My TV continues to record the program for up to 30 minutes. If you paused live TV for more than 30 minutes, you cannot play the show from the exact point where you paused it.
Stop ■	<b>Stop</b> to halt live TV. My TV continues to record the program for up to 30 minutes. If you stop live TV for more than 30 minutes, you cannot play the broadcast from the exact point where you stopped it.
Play ▶	<b>Play</b> to resume watching TV where you left off when you pressed the Pause or Stop button. Press the <b>Stop</b> button to stop viewing live or recorded TV.
Fwd ▶▶	<b>Fwd</b> (Fast forward) to advance through a live TV or recorded program that has been stopped or paused and recorded to the program buffer. Press the <b>Fwd</b> button a second or third time to increase the fast forward speed.
Rewind ◀◀	<b>Rew</b> (rewind) to go back in a program that has been stopped or paused and recorded to the program buffer. Press the <b>Rew</b> button a second or third time to increase the rewind speed.
Skip ▶	<b>Skip</b> once to advance 29 seconds through a recorded program that has been stopped or paused and recorded to the program buffer. You can press the <b>Skip</b> button repeatedly, but only until you reach the end of the program buffer.
Replay ◀	<b>Replay</b> once to go back 7 seconds in a live TV or recorded program that has been stopped or paused and recorded to the program buffer. You can press the <b>Replay</b> button repeatedly, but only until you reach the beginning of the program buffer.



### Tip:

To change the display's aspect ratio with the remote, press the **More Info** button, then press **Zoom**.

## To rewind and replay a buffered TV program

- On the remote, press the **Rew** ◀ button until you locate the point in the TV program that you want to replay, then press the **Play** button. The buffered program plays and live TV continues to record to the buffer.



### Tip:

My TV buffers 30 minutes of TV program segments. You can replay buffered TV programs for up to 30 previous minutes of the program's broadcast. If you want to replay longer TV programs or save them to watch later, use the My TV record features. For more information, see "Recording TV programs" on page 47.



### Tip:

When you change channels, the program buffer deletes the buffer content from the current channel and begins recording the new channel to the program buffer.



### Help:

For more information about watching buffered TV programs, see topics in *About My TV* section of the Windows XP Media Center Help. To open the Windows XP Media Center Help, move the mouse to activate the menu bar, then click the Help button

## To pause or stop and replay a buffered TV program

- 1 On the remote, press the **Pause** || or **Stop** ■ button at the point in the TV program that you want to pause or stop the program. Live TV continues to record to the buffer for up to 30 minutes.



- 2 Press the **Play** button when you want to return to watching the program. The program starts playing from the point where you paused it.

You can continue watching the buffered program or fast forward, rewind, skip, or replay segments that were buffered. If you want to return to Live TV and skip past the buffered broadcast segments, press the **Live TV** button.

# Using the Guide

The Guide displays channel and TV program information, TV program titles, descriptions, categories, ratings, and program times. You can view and scroll through the list of current and future TV shows in the Guide. When you select a program title, information about the program displays below the program listings.

Use the Guide to select programs to watch, set up program recordings, and search for TV programs.

## To start the Guide

- On the remote, press the **Guide** button. The Guide opens.



### Help:

For information about watching Pay-Per-View programs on your Family Media Center, see topics in *About the Guide* section of the Windows XP Media Center Help. To open Windows XP Media Center Help, move the mouse to activate the menu bar, then click the Help button

## To select a program listed in the Guide

- 1 With the Guide open, press the up ▲, down ▼, left ◀, or right ▶ remote navigation buttons to scroll through the TV listings line-by-line.

- OR -

Press the **CH/PG +** or **CH/PG -** buttons on the remote to scroll through the TV listing page-by-page.



- 2 Highlight the program you want to watch and press the **OK** button. One of the following will occur:
  - If the program is currently broadcasting, the window will maximize and display the program.
  - If the program is scheduled to broadcast at a later time, a detailed program information page opens. You can select a recording option.

# Manually updating the Guide

When you use the Windows XP Media Center setup wizard, you can set up the Guide to automatically download program information from your cable or satellite service provider. However, if your Internet Service Provider does not support automatic Guide updates or if the Guide needs to be updated for another reason, you may need to update the Guide manually to refresh the program listings.

## To manually update the Guide

- 1 Before starting the Windows XP Media Center, make sure that you connect to the Internet.



### Tip:

The Windows XP Media Center requires Internet access to update the Guide. Make sure that you connect to your Internet connection before continuing the manual Program Guide update instructions. Contact your Internet Service Provider for more information.



### Help:

For more information about using and configuring the Guide, see topics in *About the Guide* section of the Windows XP Media Center Help. To open Windows XP Media Center Help, move the mouse to activate the menu bar, then click the Help button

- 2 On the remote, press the **My TV** button. The Windows XP Media Center My TV starts.



- 3 Navigate to **Settings**, then press the **OK** button. The *Settings* menu opens.



- 4 Navigate to **Guide**, then press the **OK** button.
- 5 Navigate to **Get Guide data**, then press the **OK** button. A message asks if you want to update the Guide information now.
- 6 Navigate to **Yes**, then press the **OK** button. The Windows XP Media Center downloads Guide updates.

# Recording TV programs

Your Family Media Center lets you record the program you are watching, record a program that is scheduled to broadcast later, or record a recurring program series.

## To record the program you are watching

- 1 Use the **CH/PG +** or **CH/PG -** buttons, numeric keypad, or the Guide to choose programs that you want to record.
- 2 On the remote, press the **Record**  button. The program recording starts.



- 3 To end the program recording, press the **Stop**  button or let the recording stop automatically when the current program is over.

 **Tip:**  
When recording a program, you can only watch the program that is recording. If you change channels during a program recording, the recording stops.

 **Tip:**  
To record programs to the hard drive, your Family Media Center must be turned on, in standby mode, or hibernate mode. For more information about using standby and hibernate, Click **Start, Help and Support**, then search for the keywords *standby* or *hibernate*.

## To set up a recording from the Guide

- 1 On the remote, press the **Guide** button. The Guide opens.
- 2 Highlight the TV program you want to record, then press the **Record**  button. The record icon appears next to the program to indicate the recording has been scheduled.



The program automatically records when the scheduled program begins broadcasting and stops recording when the program broadcast ends.

 **Tip:**  
The Guide is available to multiple user accounts on the Windows XP Media Center. However, the program recording schedules are shared among all accounts. A program recording conflict message appears if a user tries to schedule a recording for a time that has already been scheduled.



### Tip:

When you schedule to record a program series, the Windows XP Media Center records each series episode from any channel that broadcasts the program series. Windows XP Media Center will not record duplicate programs from the series and it will look for alternative broadcasts times if a recording time conflict occurs.



### Help:

For more information about recording programs manually, recording programs from search, and other recording methods, see topics in *Record TV* located under the *My TV* section of the Windows XP Media Center Help. To open Windows XP Media Center Help, move the mouse to activate the menu bar, then click the Help button .

## To set up a recording for a program series

- 1 On the remote, press the **Guide** button. The Guide opens.
- 2 Highlight the program you want to record, then press the **Record**  button two times to record a program series. The record series icon appears next to the program to indicate that the recording has been scheduled for all programs in this series.



The program automatically records each time the scheduled series broadcasts from any channel and stops recording when the program broadcast ends.

## To change program recording settings

- 1 On the remote, press the **Guide** button. The Guide opens.
- 2 Highlight the program that you have scheduled to record, then press the **OK** button. The Program Info window opens.



- 3 Highlight a menu option, press the **OK** button, then change the record settings to your preferences.



### Help:

For more information about managing Recorded TV, see topics in *Record TV* located under the *Manage Recorded TV* section of the Windows XP Media Center Help. To open Windows XP Media Center Help, move the mouse to activate the menu bar, then click the Help button .

# Using Recorded TV

Use Recorded TV to view and manage your program recordings. After you have recorded TV programs, go to Recorded TV to sort programs by date, name, and category. You can also schedule new program recordings and watch and manage scheduled program recordings.

## To watch and manage Recorded TV

- 1 On the remote, press the **My TV** button. The Windows XP Media Center starts.
- 2 Navigate to **Recorded TV**, then press the **OK** button. The *Recorded TV* menu opens. A list of previously recorded and currently recording programs is displayed.



### Tip:

On the remote, you can also press the **Recorded TV** button for a shortcut to access Recorded TV.

In Recorded TV you can:

- Select **Sort by date**, **Sort by name**, or **Sort by category** to set your program list viewing preference.

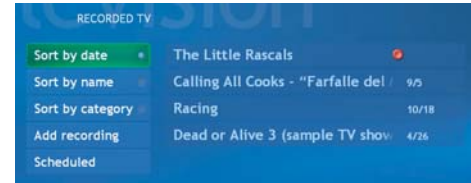

To play, delete, or keep a recorded program until a specified date, navigate to a recorded program, then press the **OK** button. Select the program option.

- Select **Add recording** and schedule a new program recording with **Guide** or **Search**, with **Channel and time**, or by **Keyword**.

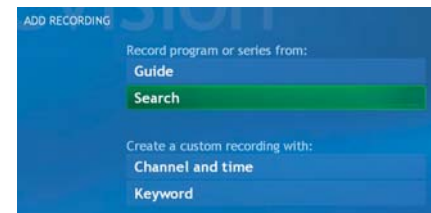

- Select **Scheduled** to view and manage future program recording options.



# Changing My TV Settings

Use My TV Settings to customize the Windows XP Media Center My TV. You can adjust settings for the TV recorder, Guide, TV signal, display settings, audio, and My TV.

## To use the Settings menu

- 1 On the remote, press the **My TV** button. The Windows XP Media Center starts.
- 2 Navigate to **Settings**, then press the **OK** button. The *Settings* menu opens.



### Help:

For more information about the My TV Settings options, see topics in *Change settings for My TV* located under the *My TV* section of the Windows XP Media Center Help. To open Windows XP Media Center Help, move the mouse to activate the menu bar, then click the Help button .

In Settings you can:

- Select **Recorder** to view the TV program recording history log, change drive storage settings (such as how much disk space to allocate for program recordings), and change the TV program recording quality setting. Also, you can see how much recording time has been used, how much is available for recording new programs, what the recording default settings are, and more.
- Select **Guide** to edit the Guide listings, add missing channels to the Guide, reset the Guide lineup, and update the Guide information.
- Select **Set up TV signal** to choose the video service, such as cable, satellite, or antenna, that is connected to your Family Media Center.
- Select **Adjust display settings** to adjust the video settings for the display.
- Select **Audio** to set audio, captioning, and captioning display options.
- Select **My TV** to choose whether to automatically start playing the TV after starting My TV or whether to start playing the TV only when you select Live TV.



# Burning recorded TV programs to DVD

After you have recorded a TV program, you may want to save the program to a DVD to watch on another computer that has a DVD player or your home DVD player. Use Sonic PrimeTime to copy the recorded program to a DVD (a recordable DVD drive is optional for the Gateway FMC-901 Media Center).



## Tip:

Record TV programs to DVD-R type DVDs.

## To use Sonic PrimeTime

- 1 Press the Start  button on the remote. The Windows XP Media Center menu is displayed.
- 2 Highlight **Create DVD**, then press the **OK** button. The Media Center minimizes and Sonic PrimeTime opens.



## Tip:

If your Gateway 901 Series Media Center does not include a recordable DVD drive but includes a recordable CD drive, you can change the recording device option to Video CD (VCD) and record TV programs to a CD. The program will record in a lower quality video format, but will compress to fit on a CD. To change the recording device, click **Settings, General, Recording Devices**, then select the type of recording device you want to record programs to.

- 3 Use **Sort by date**, **Sort by name**, or **Sort by category** to locate the recorded TV program you want to record to DVD.
  - 4 Use the remote to highlight the TV program or programs that you want to record, then press the **OK** button.
- As you select TV programs, check marks appear beside the programs and the DVD icon shows the recording space available on the DVD.



- 5 After you have selected the TV programs you want to record, highlight **Burn DVD**, then press the **OK** button. A message tells you that running additional programs while burning a DVD may cause the recording to fail.
- 6 If you have a number of programs running, close the programs, then click **OK**. The TV programs burn to the DVD.



**+** **Tip:** DVD-Rs have a 4.7 GB maximum capacity. If the TV program you want to record is long enough to require more than 4.7 GB of recording space, you can reduce the Windows XP Media Center program recording quality setting before recording the program. The record quality setting options are Fair, Good, Better, or Best:

Recording quality	Approximate GB/hour
Best	3.0
Better	2.5
Good	2.0
Fair	1.0

Lowering the recording quality reduces the TV program recording space requirement, which may reduce the TV program file size enough for the program to fit on a recordable DVD (depending on the TV program length).

For more information about setting the recorded image quality option, see the topics in *Change settings for My TV* located under the *My TV* section of the Windows XP Media Center Help. To open Windows XP Media Center Help, move the mouse to activate the menu bar, then click the Help button .



# Using My Music

- Browse music selections
- Search for music by titles and keywords
- Play music
- Add songs and audio files to the Media Library
- View music CD information such as artist name, song title, album cover art, and more

## Chapter Four

# Getting started with My Music

My Music lets you enjoy a complete music experience from the Windows XP Media Center. You can listen to CDs, view artist information, create your own music playlists, categorize and listen to music by genres, search for music selections, and more.

The Windows XP Media Center lets you play these digital audio file types:

File type (format)	File extension
CD audio	.cda
Windows Media audio files	.asx, .wm, .wma, .wmp, .wmx
Windows audio files	.wav
MP3	.mp3 and .m3u



## Tip:

Additional audio formats may be supported if you install new codecs (compressor/decompressor software used to compress and decompress digital media files) to play the audio file.

## Adding music files to the Media Library

The Windows XP Media Center My Music works with the Windows Media Player. Use the Windows Media Player to add, delete, categorize, and organize music. Then use My Music to view, sort, play, and search for music.

### To add music files on your Family Media Center to the Media Player's Media Library

- 1 With the mouse, click **Start**, then click **Windows Media Player**. Windows Media Player opens.

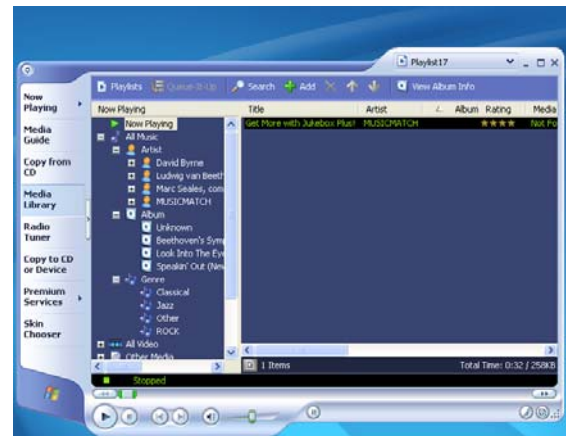

- 2 On the left side of the Media Player, click **Media Library**. The first time you click Media Library, a message tells you that the Media Player needs to search your Family Media Center for music files.

- 3 If this is the first time you've added music files to the Media Library, click **Yes**. The Media Player searches for all music files on your Family Media Center and adds them to the Media Library.

- OR -

If you want to add new music files to the Media Library, click the show menu bar arrow  to display the menu bar, click **Tools**, then click **Search for Media Files**. The *Add To Media Library By Searching Computer* dialog box opens.

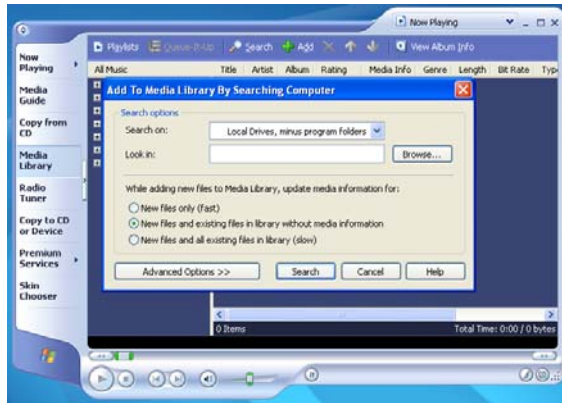

Select search options, then click **Search**. The Media Player searches for music files on your Family Media Center and adds them to the Media Library.



## Help:

You can add music CD files to the Media Library in Media Center's My Music, however you cannot delete, move, rename, and organize music files with My Music features. For a variety of music file management capabilities, use the Media Player's My Library features.

For more information about managing music files, see topics in *Add songs and audio files to the Media Library* located under the *My Music* section of the Media Center Help. To open Media Center Help, move the mouse to activate the menu bar, then click the Help button .

## Adding music CDs to the Media Library

You can add and organize your personal CD collection with the Media Player's Media Library, then use the Windows XP Media Center as your personal jukebox to play and enjoy your music. First use Media Player to copy, add, delete, move, create personal playlists, rename files on the hard drive, and more.

After you've customized your music files using the Media Library, then use the Windows XP Media Center to play music and view song, track, and artist information.

### To add music files from a CD to the Media Player's Media Library

- 1 With the mouse, click **Start**, then click **Windows Media Player**. Windows Media Player opens.
- 2 Insert the CD you want to add to the Media Library.

- 3 On the left side of the Media Player, click **Copy from CD**, then click **Copy Music**.

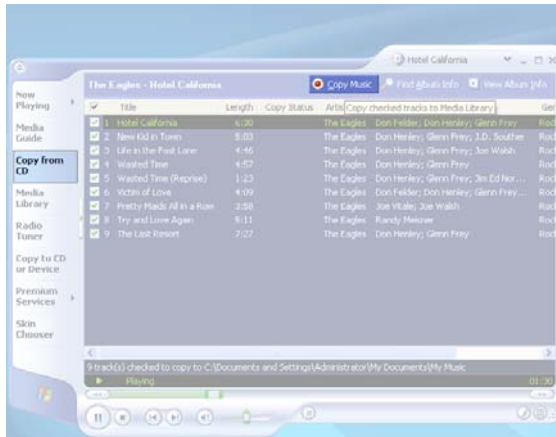

The *Copy Options (1 of 2)* dialog box opens.

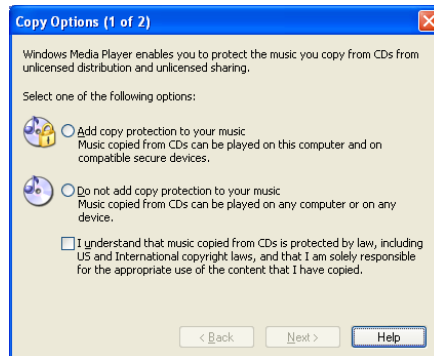

- 4 Click **Add copy protection to your music** or **Do not add copy protections to your music**, then click to select the check box next to the copyright statement. You must agree to the copyright statement and select the check box next to the copyright statement before you can continue copying the CD to your Family Media Center.
- 5 If you agree to the copyright statement, click **Next**. The **Copy Options (2 of 2)** dialog box opens.

- OR -

If you do not agree to the copyright statement, click **X** to close the dialog box and stop copying the CD to your Family Media Center.

- 6 Click **Change my current format settings** or **Keep my current format settings**, then click **Finish**. The CD copies to the hard drive.

**Tip:** When adding music files to the Media Library and playing files from your Family Media Center, make sure that you're connected to the Internet to display CD information such as artist information, CD artwork, song titles, and more.

# Playing My Music

You can play music CDs with Windows XP Media Center's My Music. After you've added your CD collection to the Media Player's Media Library, you'll have a variety of music to listen to directly from your Family Media Center. You can play individual songs, CDs (albums), shuffle play, and customize your music files for special occasions with a personalized music playlist. After you've tailored music files with the Media Library, sit back and enjoy listening to your favorite music.

## To listen to a CD

- 1 Insert the CD you want to listen to.
- 2 If the Windows XP Media Center TV or Guide is open, Media Center asks if you want to play the CD. Highlight **Yes**, then click **OK**.

- OR -

If the Windows XP Media Center is not open, the default music player may start playing the CD. If you want the Media Center to be your default CD player, see "To set Windows XP Media Center as the default CD player" on page 60.

- OR -

Press the **My Music** button. The *My Music* menu opens.

- 3 Navigate to highlight the CD selection, highlight **Play** or **Shuffle**, then press the **OK** button.



The **Now Playing** menu opens and the CD plays.



You can also:

- Select **View Song** to view the CD cover artwork and the currently playing song's title.

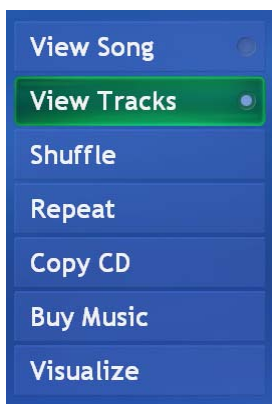

- Select **View Tracks** to view a list of all the tracks on the CD.

- Select **Shuffle** to randomly arrange the music play selections.

- Select **Repeat** to repeat play the CD.

- Select **Copy CD** to copy the CD to the hard drive and add the music files to the Media Library for future listening (also see “Adding music CDs to the

Media Library” on page 55). You can also set audio, captioning, and captioning display options.

- Select **Buy Music** to search for and purchase CDs.
- Select **Visualize** to display interesting visual patterns on-screen while your music plays.

## To listen to the Media Library music from the Windows XP Media Center

- 1 On the remote, press the **My Music** button. My Music opens.

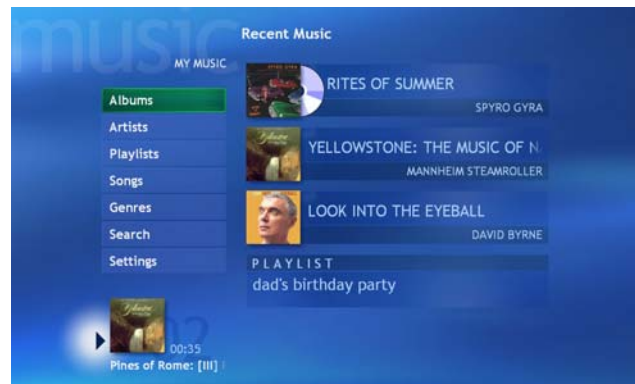



2 You can:

- Select **Albums** to play music, from your Media Library.

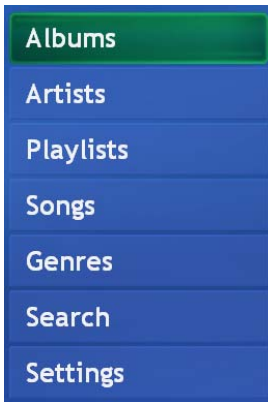

- Select **Artists** to view and play music from a list of all artists in your Media Library.

- Select **Playlists** to view and play music from your custom playlists or from auto-created playlists.

- Select **Songs** to view and play music from an alphabetized list of music files.

- Select **Genres** to view and play music from music categorized by genre, such as classical, jazz, new age, and rock.

- Select **Search** to search for music by a song title.
- Select **Settings** to change the visualizations options.

3 After you've selected your music, click **OK**. The selections play.



#### Help:

For more information about methods to browse and select music files, see topics in *Browse My Music* and *Play Music* located under the *My Music* section of the Windows XP Media Center Help. To open Windows XP Media Center Help, move the mouse to activate the menu bar, then click the Help button .

## To set Windows XP Media Center as the default CD player

- 1 With the mouse, click **Start**, then click **My Computer**. The *My Computer* window opens.
- 2 Right click the **Audio CD (D:)** drive, then click **Properties**. The *Audio CD (D:) Properties* dialog box opens.
- 3 Click the **AutoPlay** tab. The AutoPlay tab is displayed.
- 4 Click **Music CD** in the **Select a content type** list.

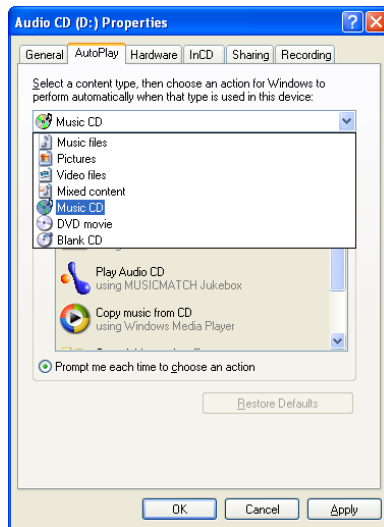

- 5 Click the **Select an action to perform** option, **Play Audio CD using Media Center** under Actions, then click **OK**.

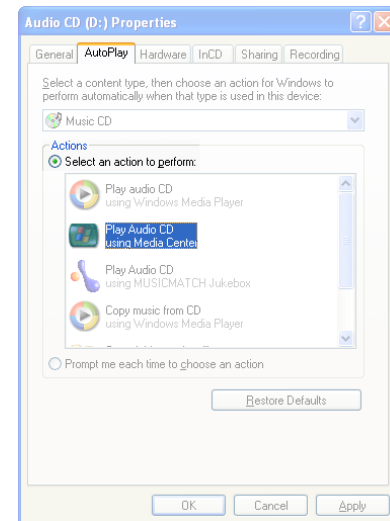

# Using My Pictures

- Manage and add pictures to your photo library
- Browse and search for pictures
- View and touch up pictures
- Print and share pictures
- Watch pictures as slide shows
- View picture details such as file name, file date, picture pixel size, where the picture is stored, and more

## Chapter Five

# Getting started with My Pictures

The Windows XP Media Center's My Pictures makes it easy and fun to look at your digital photos. My Pictures lets you view your pictures individually or as a slide show. You can organize and sort pictures by name or date. Use the keyboard, mouse, or remote to browse your pictures.

While browsing pictures or watching a slide show, you can press the **More Info** button to view more information about a picture, make adjustments to a picture, and print a picture. The Windows XP Media Center lets you view these digital image file types:

File type (format)	File extension
Joint Photographic Experts Group	<b>.jpg, .jpeg</b>
Tagged Image File Format	<b>.tif</b>
Graphics Interchange Format	<b>.gif</b> (animated .gif files are not supported)
Bitmap	<b>.bmp</b>
Windows MetaFile	<b>.wmf</b>
Portable Network Graphics	<b>.png</b>

# Organizing picture files

To view pictures and play slide shows in the Windows XP Media Center's My Pictures, first copy and organize the picture files into the My Pictures or Shared Pictures

folders. Windows XP Media Center only displays picture files placed in the My Pictures or Shared Pictures folders.

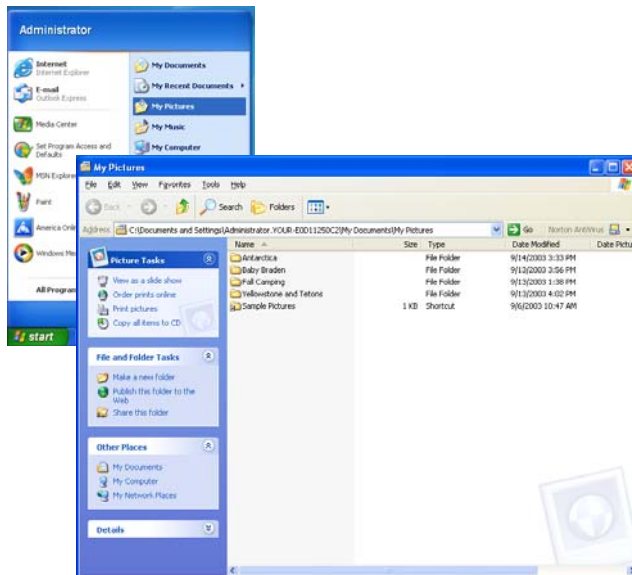

## To organize picture files

- 1 With the mouse, click **Start**, then click **My Pictures**. The *My Pictures* window opens.



- 2 Make new folders in the My Pictures folder and copy files to the folders or copy folders from other folders to the My Pictures folder.

You can also put pictures in the Shared Pictures folder to share pictures with other users.

 **Help:** For more information about managing picture files, see topics in *Work with picture files* located under the *My Pictures* section of the Windows XP Media Center Help. To open Windows XP Media Center Help, move the mouse to activate the menu bar, then click the Help button .

# Viewing My Pictures

After you've organized your picture files in the My Pictures or Shared Pictures folder, then you can view pictures in the Windows XP Media Center's My Pictures.

The picture folders are displayed just as you organized them in the My Pictures or Shared Pictures folders.

## To view pictures from the Windows XP Media Center

- 1 On the remote, press the **My Pictures** button. The *My Pictures* menu opens and the picture folders display.



- 2 Navigate to a picture folder that you want to view, then press the **OK** button. The picture folder opens.



You can view individual pictures by highlighting a picture and pressing the **OK** button.



You can also choose from the menu options:

- Select **Play slide show** to view the pictures in a slide show. The slide show automatically transitions between pictures. You can also press the left ◀ and right ▶ remote navigation buttons to view the pictures manually at your own pace.
- Select **Sort by name** to sort the pictures by the file names.

- Select **Sort by date** to sort the pictures by the file dates.
- Select **My Pictures** to view all the picture folders.
- Select **Shared Pictures** to view pictures that are shared from other users.
- Select **Other media** to view pictures that are on a removable memory card.
- Select **Settings** to change the slide show preferences, such as the order to display pictures in, whether to show pictures in subfolders, caption options, and transition effects between pictures.

## Using More Info

While viewing an individual picture or watching a slide show, you can press the **More Info** button to view picture details.

### To view More Info about a picture

- 1 On the remote, while viewing pictures, press the **More Info** button. The **Picture Details** menu opens and the picture is displayed.



Choose from the menu options:

- Select **Play slide show** to view the pictures in a slide show. The slide show automatically transitions between pictures. You can also press the left ◀ and right ▶ remote navigation buttons to view the pictures manually at your own pace.



- Select **Rotate**  to rotate the picture counter-clockwise in 90-degree increments.

- Select **Rotate**  to rotate the picture clockwise in 90-degree increments.

- Select **Print** to print a full-page picture print.

- Select **Touch up** to remove red eye and change the picture contrast.

- Select **Next** to view the next picture's details.
- Select **Previous** to view the previous picture's details.

## Playing audio during a slide show

In addition to watching slide shows, you can also play music along with your slide show.

### To view a slide show with music

- 1 Use My Music to select music from your Media Library, play a CD, or select a music playlist. For more information, see "Playing My Music" on page 57.
- 2 On the remote, press the **My Pictures** button. The **My Pictures** menu opens and the picture folders display.
- 3 Select the picture folder you want to watch as a slide show, highlight **Play slide show**, then press the **OK** button. The slide show starts.



#### Help:

For more information about slide show options and settings, see topics in *Play a slide show* located under the *My Pictures* section of the Windows XP Media Center Help. To open Windows XP Media Center Help, move the mouse to activate the menu bar, then click the Help button .



# Using My Videos



- Manage and add videos to your video library
- Browse and search for videos
- View videos
- Share videos
- View video details such as file name, file date, picture pixel size, where the picture is stored, and more

## Chapter Six

# Getting started with My Videos

The Windows XP Media Center's My Videos makes it easy to enjoy your digital videos. My Videos lets you watch and share your videos. You can organize and sort videos by name or date. Use the keyboard, mouse, or remote to browse your videos.

The Windows XP Media Center lets you watch these digital video file types:

File type (format)	File extension
Windows Media file	<b>.wm, .asf</b>
Windows Media A/V	<b>.wmv</b>
Video file	<b>.avi</b>
Movie file	<b>.mpeg, .mpg, .mpe, .m1v, .mp2, .mpv2</b>
Windows MetaFile	<b>.wmf</b>

While browsing or viewing videos, you can press the **More Info** button to view more information about video.



## Tip:

Additional video formats may be supported if you install new codecs (compressor/decompressor software used to compress and decompress digital media files) to play the video file.

# Organizing video files

To view videos in the Windows XP Media Center's My Videos, first copy and organize the video files into the My Videos or Shared Video folders. The Windows XP Media

Center only displays video files placed in the My Videos or Shared Video folders.

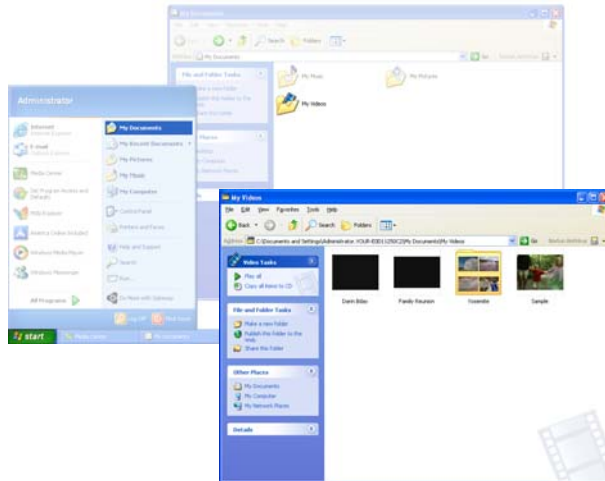

## To organize video files

- 1 With the mouse, click **Start**, **My Documents**, then click **My Videos**. The *My Videos* window opens.



- 2 Make new folders in the My Videos folder and copy files to the folders or copy folders from other folders to the My Videos folder.

You can also put videos in the Shared Video folder to share videos with other users

 **Help:** For more information about managing video files, see topics in *Manage video files* located under the *My Videos* section of the Windows XP Media Center Help. To open Windows XP Media Center Help, move the mouse to activate the menu bar, then click the Help button .

# Viewing My Videos

After you've organized your video files in the My Videos or Shared Videos folder, you can view videos in the Windows XP Media Center's My Videos. The video clips

are displayed just as you organized them in the My Pictures folder.

## To view videos from the Windows XP Media Center

- 1 On the remote, press the **My Videos** button. The **My Videos** menu opens and the videos and video folders display.



- 2 You can view videos by highlighting a video and pressing the **OK** button.

You can also choose from the menu options:

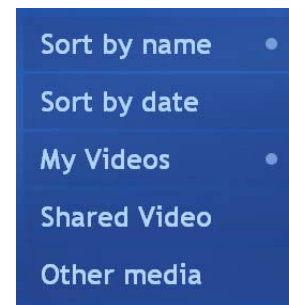

- Select **Sort by name** to sort the videos by the file names.
- Select **Sort by date** to sort the videos by the file dates.
- Select **My Videos** to view all the videos.
- Select **Shared Video** to view videos that are shared from other users.
- Select **Other media** to view videos that are on a removable memory card.

# Using More Info



While viewing videos, you can press the **More Info** button to view information about the video (if available) and change the video display's aspect ratio.

## To use More Info for videos

- 1 On the remote, while viewing videos, press the **More Info** button. More information is displayed along the bottom of the screen.



- 2 Press the **OK** (Zoom) button to toggle through the various aspect ratio screen display options.

 **Help:**  
For more information about using My Videos, see topics in *My Videos* section of the Windows XP Media Center Help. To open Windows XP Media Center Help, move the mouse to activate the menu bar, then click the Help button .



# Using Play DVD

- Play DVDs
- Set language, subtitles, and audio defaults

## Chapter Seven

# Playing a DVD

You can watch a DVD with the Windows XP Media Center. If the Windows XP Media Center is running when you insert a DVD into the DVD drive, a message asks if you want to play the DVD. If you select **Yes** or do not make a selection, the DVD plays automatically. If you select **No**, then you can play the DVD in Windows XP Media Center at any time by selecting **DVD Menu** or **Play DVD** on the Media Center Start menu.

## To watch a DVD on the Windows XP Media Center

- 1 Insert the DVD you want to watch.
- 2 If the Windows XP Media Center is already running, a message asks if you want to play the DVD. On the remote, highlight **Yes**, then press the **OK** button. The DVD plays.

- OR -

If you are not using Windows XP Media Center when you insert a DVD, a *What do you want to do?* dialog box opens. Click **Play DVD Video using Media Center**. If you want the Windows XP Media Center to always play DVDs using the Media Center, click to select the **Always do the selected action** check box. The DVD plays.



- OR -

If a DVD player installation program opens (for player software that was included with the DVD), cancel the installation, then press the Start  button on the keyboard or remote. The Windows XP Media Center starts.



## To select DVD menu options

- 1 Press the **DVD menu** button. The DVD menu opens.



- OR -

Press the **Stop** ■ button. The Stopped DVD menu opens.

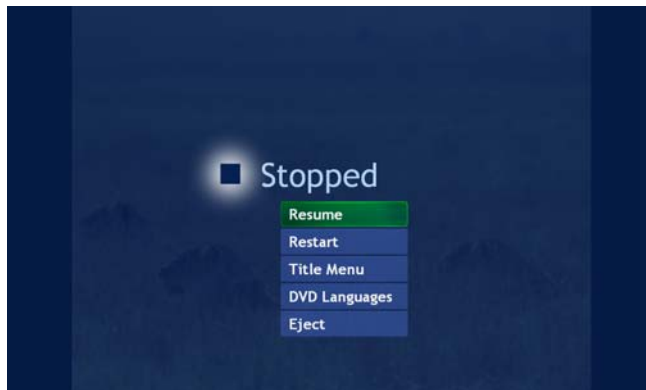

- 2 On the remote, highlight the menu option you want to select, such as language, subtitles, and others, then press the **OK** button.

 **Tip:**  
DVD menu options vary and depend on the options provided by the DVD publisher.



# Using Radio

- Play FM and Internet radio
- Preset favorite radio stations
- Rewind, pause, stop, skip forward, and play radio recordings

## ChapterEight

# Playing the Radio

You can enjoy the Family Media Center's FM radio and control playback with the remote. When you play the radio, the Windows XP Media Center records (buffers) up to 30 minutes of the radio program much like My TV does. This lets you go back and review part of the radio broadcast you heard earlier or listen to a broadcast segment that you missed while away from the radio.

**Tip:** The Media Center Radio buffers up to 30 minutes of a radio program. However, it does not let you schedule a radio recording or manually record radio programs.

While listening to FM radio you can pause, play, stop, skip forward, or skip back in the audio stream. You can also change to a different station by tuning to a specific frequency, seeking the next available station, or selecting a radio preset.

**Tip:** The Media Center FM radio shares the single tuner card with **My TV**. You cannot watch or record TV and listen to FM radio at the same time. When Windows XP Media Center is scheduled to start a TV program recording, a warning appears that says FM radio stops when the TV recording starts. If you do not select **Cancel recording**, Windows XP Media Center automatically stops the radio and begins recording TV.

## To auto-tune the FM radio with Seek

- 1 On the remote, press the **Radio** button. The *Radio* window opens.

- 2 With the remote, highlight **Seek +** or **Seek -**, then press the **OK** button. The radio auto-scans for radio stations.

When a station signal tunes in, the auto-scan stops on the station.



You can:

- Listen to the radio station.
- Highlight the **Save** button, then press the **OK** button to save this station on the next available preset radio memory slot.
- Highlight **Seek +** or **Seek -** to continue auto-scanning for stations.



## To manually-tune the FM radio with Tune

- 1 On the remote, press the **Radio** button. The *Radio* window opens.
- 2 With the remote, highlight **Tune +** or **Tune -**, then press the **OK** button repeatedly to manually scan for radio stations. When you tune a station, you can:

- Listen to the radio station.
- Highlight **Save**, then press the **OK** button to save the station on the next available preset radio memory slot.
- Highlight **Tune +** or **Tune -** to continue manually scanning for stations.



**+ Tip:** If you know the radio station's frequency, you can highlight the radio station frequency number box and type the station number you want to tune in.

## To play FM radio

- On the remote, tune to an FM station or select a preset station, highlight **Start Radio**, then press the **OK** button. (you can also press the remote **Play ▶** button). The radio starts playing and recording (buffering) up to 30 minutes of the radio program.

## To listen to Internet radio

- 1 On the remote, press the **Radio** button. The *Radio* window opens.
- 2 Navigate to **Internet**, then press the **OK** button.
- 3 Navigate to highlight one of the Internet radio Web links from the list.

**+ Tip:** The Internet button appears in the Windows XP Media Center **Radio** only if one or more Internet radio Web links have been installed. Go to **Online Spotlight** to check for Internet radio Web links that you can download and use in Windows XP Media Center (press the Start  button on the remote, highlight **Online Spotlight**, then press the **OK** button).

# Using the remote to play Radio recordings

When you play the radio, the Windows XP Media Center automatically records radio programs to a program buffer as you listen. When you stop or pause radio programs, the radio continues recording (buffering) the program for up to 30 minutes so you can listen to the broadcast

where you previously left off. You can also press the **Replay** button, while listening to a program, to rewind and replay a segment of the radio program. Use the remote transport buttons or the transport controls toolbar to control radio playback.

Remote button	Press:
Pause 	<b>Pause</b> to pause the radio program. While paused, the radio continues to record the radio program for up to 30 minutes. If you pause the program for more than 30 minutes, you cannot play the radio from the exact point where you paused it .
Stop ■	<b>Stop</b> to stop the radio program. Windows XP Media Center continues to record the radio program for up to 30 minutes. If you stop the program for more than 30 minutes, you cannot play the radio from the exact point where you stopped it.
Play ▶	<b>Play</b> to resume listening to the radio where you left off when you pressed the Pause or Stop button. Press the <b>Stop</b> button to stop listening to a live or recorded radio broadcast.
Fwd ▶▶	<b>Fwd</b> (Fast forward) to advance through a live or recorded radio program that has been stopped or paused and recorded to the program buffer. Press the <b>Fwd</b> button a second or third time to increase the fast forward speed.
Rewind ◀◀	<b>Rew</b> (rewind) to go back in a radio program that has been stopped or paused and recorded to the program buffer. Press the <b>Rew</b> button a second or third time to increase the rewind speed.
Skip ▶	<b>Skip</b> once to advance 29 seconds through a recorded radio program that has been stopped or paused and recorded to the program buffer. You can press the <b>Skip Forward</b> button repeatedly, but only until you reach the end of the program buffer.
Replay ◀◀	<b>Replay</b> once to go back 7 seconds in a live or recorded radio program that has been stopped or paused and recorded to the program buffer. You can press the <b>Replay</b> button repeatedly, but only until you reach the beginning of the program buffer.

# Changing Radio Settings

Use Radio Settings to customize the Windows XP Media Center Radio. You can change, remove, and reorder

the FM radio preset stations. You can also auto-sort the stations in numeric order.

## To use the Settings menu

- 1 On the remote, press the **Radio** button. The *Radio* window opens.
- 2 Navigate to **Settings**, then press the **OK** button. The *Settings* menu opens.



In Settings you can:

- Go to the text field for the radio station preset that you want to change, then use the numeric keypad to enter a minimum of three new digits.
- Use the up arrow or down arrow, in the FM radio preset list, to move a radio station up or down the list.
- Select the **X** next to a radio preset station to delete it.
- Select **Auto Sort** to sort the radio presets in numeric order.



## Help:

For more information about the Radio Settings options, see topics in *Manage FM radio presets* located under the *Radio* section of the Windows XP Media Center Help. To open Windows XP Media Center Help, move the mouse to activate the menu bar, then click the Help button







# Using Other Features

- Adjust Windows XP Media Center Settings
- Use More Programs
- View the Online Spotlight

## Chapter Nine

# Changing Windows XP Media Center Settings

You can access most of the Settings menus within a specific Windows XP Media Center feature, such as My TV, My Pictures, My Music, and others. However, you can also access all of the Settings menus from **Settings** on the Windows XP Media Center's main menu. This

menu provides easy access to all of the Settings menus, including the Windows XP Media Center general settings.

Browse the Settings menu to familiarize yourself with the Windows XP Media Center settings options.

## To access the Settings menu

- 1 Press the Start  button on the remote. The Windows XP Media Center menu is displayed.
- 2 With the remote, highlight **Settings**, then press the **OK** button. The **Settings** menu is displayed.



### Help:

For more information about the Settings menu options, see topics in *Change settings in Media Center* section of the Windows XP Media Center Help. To open Windows XP Media Center Help, move the mouse to activate the menu bar, then click the Help button .

# Using More Programs

More Programs gives you access to other programs and games available to use or play from the Windows XP Media Center.

## To use More Programs

- 1 Press the Start  button on the remote. The Media Center menu is displayed.
- 2 Highlight **More Programs**, then press the **OK** button. The **Programs** menu is displayed.
- 3 Highlight a program or game, then press the **OK** button.
- 4 When finished, close the program or game. On the remote, press the **Back** button to return to the Media Center menu.

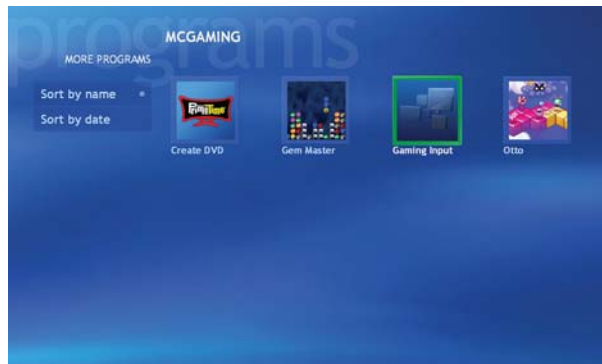

# Using Online Spotlight

The Windows XP Media Center Online Spotlight highlights new ways to enjoy and use your Family Media Center. Check the Online Spotlight regularly to learn more tips and tricks and to get the most out of your Family Media Center experience.

## To access the Online Spotlight

- 1 Press the Start  button on the remote. The Media Center menu is displayed.
- 2 With the remote, highlight **Online Spotlight**, then press the **OK** button. The *Online Spotlight* page opens.
- 3 Browse information to learn more about the Windows XP Media Center.
- 4 When finished, on the remote, press the **Back** button to return to the Windows XP Media Center menu.

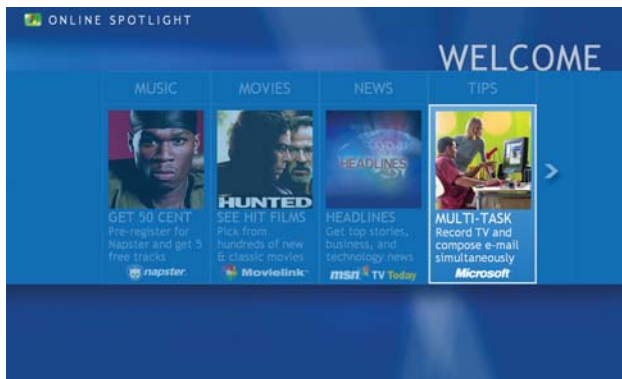

# Getting Help

- Get answers to Frequently Asked Questions (FAQs)
- Learn about the Windows XP Media Center online help and other information resources
- Get Gateway contact information

## Chapter Ten

# Media Center FAQs

Following are Family Media Center Frequently Asked Questions (FAQs). To view other Media Center FAQs that are not covered in this section, go to the Gateway support Web Site at [support.gateway.com/windowsxp/mediacenter/faqs/](http://support.gateway.com/windowsxp/mediacenter/faqs/).

**Q:** Why does the Family Media Center video display look bad on my TV?

**A:** Many factors, such as the display type, quality of the video source, type of connection used, quality of video cables, display device screen resolution, size of TV, age of the TV, or the type of TV (interlaced or progressive scan), can affect the video quality substantially:

- **Display type** — The Family Media Center is best viewed on display devices recommended for the Family Media Center by Gateway. Other types of display devices, including retail TVs, may provide lower quality video. If you did not order a display device when you purchased your Family Media Center, a progressive scan display device with a DVI or VGA input is the best choice.
- **Quality of video source** — The quality of the video signal coming into the Family Media Center has an affect on the video quality. The video displayed from the Family Media Center is only as good as the source video signal. Cable, digital cable, and satellite usually provide better quality than an antenna.
- **Type of connection used** — You can connect the Family Media Center video output to a TV. However, the connection type has an affect on the video quality. The Family Media Center has three video

outputs:

**DVI** — If your TV includes a DVI port, connect the DVI cable from the Family Media Center's DVI port to the TV's DVI In port for the best quality. Many TVs do not have a DVI port.

**VGA** — If your TV includes a VGA port, connect the VGA cable from the Family Media Center's VGA (monitor) port to the TV's VGA In port for the better quality. Many TVs do not have a VGA port.

**S-Video** — If your TV does not have a DVI or VGA port, but includes an S-Video port, connect the S-Video cable from the Family Media Center's S-Video Out port to the TV's S-Video In port. S-Video display quality is usually good for TV images. The display quality for the Family Media Center computer functions, however, is not as good as DVI or VGA output. S-Video display output is not optimized for computer video display.

- **Quality of video cables** — Poor quality cables or the incorrect type of video cables can cause problems and affect the video quality. Gateway recommends using high quality video cables that can be purchased from Gateway on the Web, in a Gateway store, or on the phone.

**Note:** Cable connections must be connected correctly for optimal video quality. A poor cable connection can lower video quality.

- **Screen resolution** — By default, if your display device was purchased with the Family Media Center, the computer uses a screen resolution of 1024 x 768 for computer monitors and 800 x 600 for the Gateway 42-inch Plasma TV. Many TVs cannot display this high resolution and may shift, scramble, or scroll the picture. For a better picture on a TV display, you may need to lower the Family Media Center screen resolution to 800 x 600 or 640 x 480. For more information about adjusting display settings, click **Start**, then click **Help and Support**. Type the keyword *changing display settings* in the **Search** box, then press **Enter**.
- **Size of display device** — Small computer monitors for standard computer applications are generally not optimized for motion video playback. Although they offer excellent resolutions and refresh rates, they are designed to make static white backgrounds with black text look readable. Some small display devices do not make colorful motion video look its best. Generally, video will look better on a larger display device.
- **Age of the TV** — Newer TVs usually have more advanced features, produce a better quality picture, and support higher screen resolutions. The Family Media Center external video display will likely be better on a newer model TV.

- **Type of TV** (interlaced or progressive scan)

Many TVs use *interlaced video*. Interlaced video displays a video frame with two passes of alternating scan lines. The TV screen first displays the video image odd lines one at a time, sequentially from top to bottom, then it fills in the other half of the video image with the even lines. Because most TVs use this interlaced method to display the picture on the screen, a standard interlaced analog TV will most likely flicker when displaying thin lines and small text. An interlaced video display device will produce a lower quality display, especially when viewing and using the Family Media Center computer functions.

*Progressive scan video* displays a video frame with one pass of sequential scan lines. A progressive scan TV displays the entire picture, drawn sequentially from top to bottom, without the odd/even interlacing. This results in a fuller, sharper picture and better display quality for viewing and using the Family Media Center computer functions. The progressive scan picture is also brighter and easier on your eyes.

**Q:** How do I configure my Family Media Center to output to a TV?

**A:** Your Family Media Center detects whether you are using a DVI, VGA, or an S-Video display device and automatically changes the display settings for the type of display device you are using. For more information, review the FAQ topic at:

[support.gateway.com/windowsxp/mediacenter/faqs/](http://support.gateway.com/windowsxp/mediacenter/faqs/)

**Q:** What display setting can I change to get better TV or DVD image quality?

**A:** Adjust the display device brightness, contrast, hue, and saturation.

- OR -

Use the *Adjust display settings* calibration wizard to adjust the display type, display width, connection type, and display calibration. The Adjust display settings options are located under the Windows XP Media Center Settings, TV menu options. For more information about accessing the Windows XP Media Center Settings menu, see “Changing Windows XP Media Center Settings” on page 84.

For more information, review the FAQ topic at: [support.gateway.com/windowsxp/mediacenter/faqs/](http://support.gateway.com/windowsxp/mediacenter/faqs/)

**Q:** Can I burn TV programs that were recorded with my Family Media Center to a DVD-R disc?

**A:** Yes. Windows XP Media Center saves recorded TV programs in the .DVR-MS format. You can burn a .DVR-MS file to a DVD with DVD recording (burning) software, such as Nero Express and Sonic PrimeTime.

**Q:** Can I play recorded TV programs on other computers?

**A:** You can record a TV program to DVD with Sonic PrimeTime. Sonic PrimeTime records the DVD in a DVD format much like a DVD movie. If you want to view the DVD on a computer, you need a DVD player and DVD decoder software (such as WinDVD). You **do not** need Windows XP Service Pack (SP) 1, Windows Media Player 9, and the Windows patch Q810243 Update

(described above) on your computer to play TV programs recorded with Sonic PrimeTime.

- OR -

Yes, you can record a .DVR-MS file, as a data file, to DVD with Nero Express and the DVD can be replayed on another Windows XP Media Center computer or on a non-Windows XP Media Center computer that has a DVD player and DVD decoder software (such as WinDVD). The non-Windows XP Media Center computer must also have Windows XP with Service Pack (SP) 1, Windows Media Player 9, and the Windows patch Q810243 Update.

**Q:** Can I play recorded programs on my home DVD player?

**A:** Yes. Sonic PrimeTime, records DVDs to a format that home DVD players can read. For more information, see “Burning recorded TV programs to DVD” on page 51.

**Q:** Why do I get this “Download Error” message when the Windows XP Media Center tries to update the Program Guide?

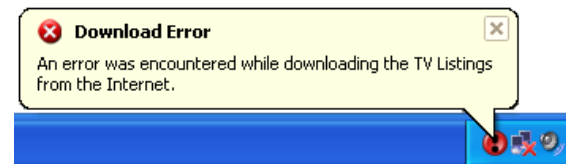

**A:** You must be connected to the Internet to update the Guide. Make sure that your Internet account is set up and connected to the Family Media Center. For information, see “Manually updating the Guide” on page 46.



# Wireless keyboard and mouse troubleshooting

Symptom	Reason	Solution
The Family Media Center does not recognize keyboard or mouse data input.	Keyboard/mouse and receiver are not synchronized.	Re-synchronize the keyboard and mouse with the Family Media Center receiver. For more information, see "Setting up and synchronizing the wireless keyboard and mouse" on page 8.
	Other radio frequency (RF) devices are interfering with the RF signal transmitted from the keyboard and mouse.	<ul style="list-style-type: none"> <li>• Change the keyboard or mouse channel. For more information, see "Changing the wireless keyboard or mouse channels" on page 34.</li> <li>• Move other RF devices away from the Family Media Center (where the RF receiver is located).</li> </ul>
	The keyboard batteries are dead or the mouse battery pack is not charged or is no longer holding a charge.	Replace keyboard batteries or recharge the mouse batteries.
The mouse LED comes on when the activate button is pressed, but the Family Media Center does not respond.	The mouse and receiver are not synchronized.	Re-synchronize the mouse with the Family Media Center receiver. For more information, see "Setting up and synchronizing the wireless keyboard and mouse" on page 8.
When using the mouse in air, the mouse pointer is visible on the screen, but does not move.	The mouse gyro is not activated.	Squeeze or double-click the activation trigger on the bottom of the mouse.
The mouse pointer movement is choppy or erratic.	Other radio frequency (RF) devices are interfering with the RF signal transmitted from the keyboard and mouse.	<ul style="list-style-type: none"> <li>• Change the mouse channel. For more information, see "Changing the wireless keyboard or mouse channels" on page 34.</li> <li>• Move other RF devices away from the Family Media Center (where the RF receiver is located).</li> </ul>
When pressing the mouse activate button, the mouse LED flashes.	Batteries are low.	Recharge or replace the battery pack. For more information, see "To install and charge the battery pack" on page 8.
When pressing the mouse activation trigger, the mouse LED is off.	Batteries are dead.	<ul style="list-style-type: none"> <li>• Recharge or replace the battery pack. For more information, see "To install and charge the battery pack" on page 8.</li> </ul>
	The mouse is turned off	<ul style="list-style-type: none"> <li>• Turn the mouse power on. For more information, see "Turning the wireless keyboard or mouse power on and off" on page 35.</li> </ul>

Symptom	Reason	Solution
The mouse pointer moves too slow or too fast.	The mouse speed or acceleration is not set correctly.	Change the mouse pointer tracking speed. For more information, see "Fine-tuning the wireless mouse pointer control" on page 34.
The mouse pointer drifts on the screen.	The mouse sensor may require recalibration.	Place the mouse on the desk for 4 or more seconds to steady the pointer.
The mouse LED does not flash in the charging cradle and the mouse does not charge.	The mouse has dirty contacts.	Clean the contacts on the bottom of the mouse.
	The battery pack recharge life has ended.	Replace the battery pack.
The mouse battery life is running out too quickly.	The mouse is being used on a dark surface.	Use the mouse on a light-colored surface to minimize battery drain.

# Getting more help

The Windows XP Media Center is easy to use when you follow the on-screen menus. However, if you need additional help or information about using the Windows

XP Media Center features, help is available at your fingertips.

## To open Windows XP Media Center Help

- 1 In the *Media Center* window, move the mouse to activate the Windows XP Media Center tool bar. The tool bar appears at the top of the window.

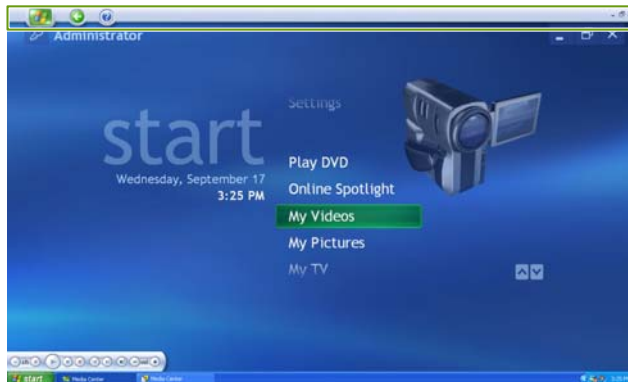

- 2 Click the **Help** ? icon to view or search for information in the Windows XP Media Center online help.



# Using Help and Support

Your Family Media Center also includes Help and Support, an easily accessible collection of help information, troubleshooters, and automated support.

Use Help and Support to answer questions about Windows and to help you quickly discover and use the many features of your Family Media Center.

## To open Help and Support

- 1 To start Help and Support, click **Start**, then click **Help and Support**. Help and Support opens.

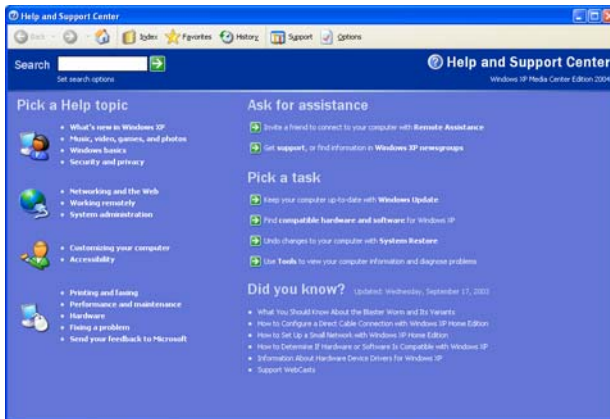

- 2 Click a topic link.

- OR -

Type a word or phrase (keyword) in the **Search** box located at the top of any Help and Support screen, then click the  arrow button to start the search. The search results appear below the search box.

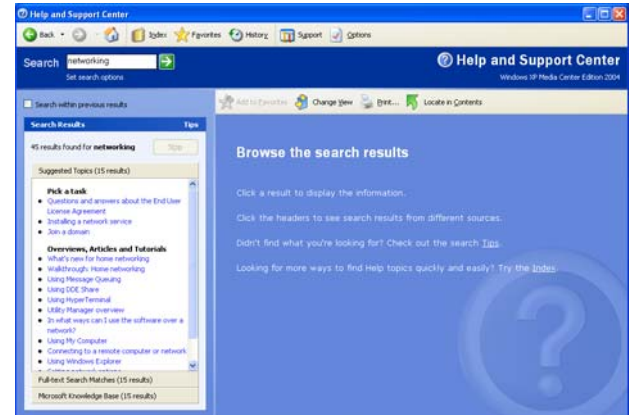

# Other Family Media Center resources

## Documentation

The **Microsoft Windows XP Media Center Edition** guide provides information about configuring the Windows XP Media Center software, tips about using the Windows XP Media Center, and troubleshooting information.

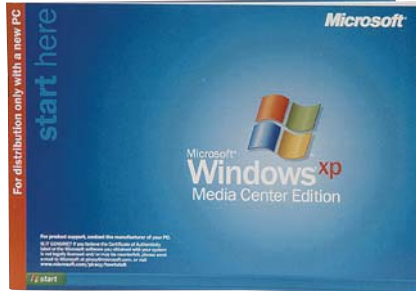

## Windows Update

Remember to check regularly for Windows updates to keep the operating system updated with the latest software releases and security updates.

To start the Windows Update utility, connect to the Internet, click **Start, All Programs**, then click **Windows Update**. The Windows Update Web site opens. Follow the on-screen instructions.

## Web site

You can get the latest FAQs, information, and tips and tricks about making the most of your Family Media Center experience. Go to the Microsoft Media Center Web site at [microsoft.com/windowsxp/mediacenter/](http://microsoft.com/windowsxp/mediacenter/) and the Gateway Support Web site at [support.gateway.com/windowsxp/mediacenter/](http://support.gateway.com/windowsxp/mediacenter/).

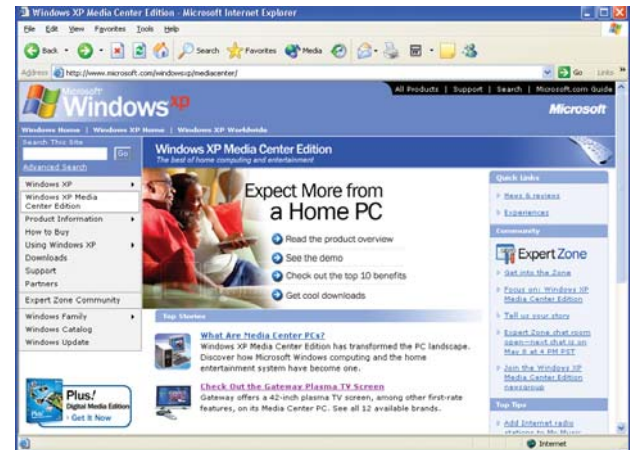

## Contacting Gateway

You can access the following services through your telephone to get answers to your questions:

Resource	Service description	How to reach
Fax on demand support	Order a catalog of documents on common problems, then order documents by document numbers. The documents will be faxed to you.	800-846-4526 (US) 877-709-2951 (Canada)
Gateway's fee-based software tutorial service	Get tutorial assistance for software issues billed by the minute.	800-229-1103 (charged to your credit card) 900-555-4695 (charged to your telephone bill)
Gateway Technical Support	Talk to a Gateway Technical Support representative about a non-tutorial technical support question.  TDD Technical Support (for hearing impaired) is available:  Weekdays 6:00 a.m. - 8:00 p.m. Central Time  Weekends 6:00 a.m. - 5:00 p.m. Central Time	800-846-2301 (US) 800-846-3609 (Canada and Puerto Rico) 605-232-2191 (all other countries) 800-846-1778 (TDD)
Sales, accounting, and warranty	Get information about available systems, pricing, orders, billing statements, warranty service, or other non-technical issues.	800-846-2000 (US) 888-888-2037 (Canada)



**Safety, Regulatory,  
and Legal Information**

**Appendix A**

# Important safety information

Your Gateway system is designed and tested to meet the latest standards for safety of information technology equipment. However, to ensure safe use of this product, it is important that the safety instructions marked on the product and in the documentation are followed.



## Caution:

Always follow these instructions to help guard against personal injury and damage to your Gateway system.

## Setting up your system

- Read and follow all instructions marked on the product and in the documentation before you operate your system. Retain all safety and operating instructions for future use.
- Do not use this product near water or a heat source such as a radiator.
- Set up the system on a stable work surface.
- The product should be operated only from the type of power source indicated on the rating label.
- If your Media Center has a voltage selector switch, make sure that the switch is in the proper position for your area. The voltage selector switch is set at the factory to the correct voltage.
- Openings in the Media Center case are provided for ventilation. Do not block or cover these openings. Make sure you provide adequate space, at least 6 inches (15 cm), around the system for ventilation when you set up your work area. Never insert objects of any kind into the Media Center ventilation openings.
- Some products are equipped with a three-wire power cord to make sure that the product is properly grounded when in use. The plug on this cord will fit only into a grounding-type outlet. This is a safety feature. If you are unable to insert the plug into an outlet, contact an electrician to install the appropriate outlet.
- If you use an extension cord with this system, make sure that the total ampere rating on the products plugged into the extension cord does not exceed the extension cord ampere rating.
- If your system is fitted with a TV Tuner, cable, or satellite receiver card, make sure that the antenna or cable system is electrically grounded to provide some protection against voltage surges and buildup of static charges.



## Care during use

- Do not walk on the power cord or allow anything to rest on it.
- Do not spill anything on the system. The best way to avoid spills is to avoid eating and drinking near your system.
- Some products have a replaceable CMOS battery on the system board. There is a danger of explosion if the CMOS battery is replaced incorrectly. Replace the battery with the same or equivalent type recommended by the manufacturer. Dispose of batteries according to the manufacturer's instructions.



### Warning:

Danger of explosion if battery is incorrectly replaced. Replace only with the same or equivalent type recommended by the manufacturer. Dispose of used batteries following the manufacturer's instructions.

- When the Media Center is turned off, a small amount of electrical current still flows through the Media Center. Always unplug all power cables and modem cables from the wall outlets before cleaning the system.
- Unplug the system from the wall outlet and refer servicing to qualified personnel if:
  - The power cord or plug is damaged.
  - Liquid has been spilled into the system.

- The system does not operate properly when the operating instructions are followed.
- The system was dropped or the cabinet is damaged.
- The system performance changes.



### Warning:

To prevent electric shock, never remove the cover. There are no user serviceable parts inside. Refer servicing to qualified service personnel.

## Replacement parts and accessories

Use only replacement parts and accessories recommended by Gateway.



### Important:

Do not use Gateway products in areas classified as hazardous locations. Such areas include patient care areas of medical and dental facilities, oxygen-laden environments, or industrial facilities.



### Warning:

To reduce the risk of fire, use only No. 26 AWG or larger telecommunications line cord.

# Regulatory compliance statements

## United States of America

### Federal Communications Commission (FCC) Intentional emitter per FCC Part 15

Your system may have a wireless keyboard and mouse included with it. The power and frequency range associated with these devices do not have the RF exposure concerns as with other wireless products.

Additional limitations, cautions, and concerns for specific countries are listed in the specific country sections (or country group sections). The wireless devices with your system are only qualified for use in the countries identified by the Radio Approval Marks on the device approval rating label. If the country you will be using the wireless device in, is not listed, please contact your local Radio Approval agency for requirements. Wireless devices are closely regulated and use may not be allowed.

The power output of the wireless device or devices that may be with your computer is well below the RF exposure limits as known at this time. Because these wireless devices emit significantly less energy than is allowed in radio frequency safety standards and recommendations, Gateway believes these devices are safe for use.

The wireless devices installed in this system are intended to be used indoors. In some areas, use of these devices outdoors is prohibited.

Some circumstances require restrictions on wireless devices. Examples of common restrictions are listed:



#### Warning:

Radio frequency wireless communication can interfere with equipment on commercial aircraft. Current aviation regulations require wireless devices to be turned off while traveling in an airplane. Do not use wireless devices at any time onboard a commercial aircraft. To minimize the possibility of interference, power off the wireless keyboard and mouse to ensure the device remains off during flight.



#### Warning:

In environments where the risk of interference to other devices or services is harmful or perceived as harmful, the option to use a wireless device may be restricted or eliminated. Airports, Hospitals, and Oxygen or flammable gas laden atmospheres are limited examples where use of wireless devices may be restricted or eliminated. When in environments where you are uncertain of the sanction to use wireless devices, ask the applicable authority for authorization prior to use or turning on the wireless device.



#### Warning:

Do not operate wireless devices unless all covers and shields are in place and the system or device is fully assembled.



#### Warning:

Wireless devices are not user serviceable. Do not modify them in any way. Modification to a wireless device will void the authorization to use it. Please contact Gateway for service.



### Warning:

The transmitting device may not be used with any antenna other than the antenna provided with them.

Operation of this device is subject to the following two conditions: (1) This device may not cause harmful interference, and (2) this device must accept any interference received, including interference that may cause undesired operation of the device.

### Unintentional emitter per FCC Part 15

These devices have been tested and found to comply with the limits for a Class B digital device, pursuant to Part 15 of the FCC rules. These limits are designed to provide reasonable protection against harmful interference in a residential installation. This equipment generates, uses, and can radiate radio frequency energy and, if not installed and used in accordance with the instructions, may cause harmful interference to radio or television reception. However, there is no guarantee that interference will not occur in a particular installation. If this equipment does cause interference to radio and television reception, which can be determined by turning the equipment off and on, the user is encouraged to try to correct the interference by one or more of the following measures:

- Reorient or relocate the receiving antenna
- Increase the separation between the equipment and receiver
- Connect the equipment to an outlet on a different circuit from that to which the receiver is connected
- Consult the dealer or an experienced radio/TV technician for help

**Compliance Accessories:** The accessories associated with this equipment are: shielded video cable when an external monitor is connected. These accessories are required to be used in order to ensure compliance with FCC rules.

## FCC declaration of conformity

Responsible party:

Gateway Companies, Inc.  
610 Gateway Drive, North Sioux City, SD 57049  
(605) 232-2000 Fax: (605) 232-2023

**Product:** 03-DT005-01

This device complies with Part 15 of the FCC Rules. Operation of this product is subject to the following two conditions: (1) this device may not cause harmful interference, and (2) this device must accept any interference received, including interference that may cause undesired operation.



### Caution:

Changes or modifications not expressly approved by Gateway could void the FCC compliance and negate your authority to operate the product.

## **Telecommunications per part 68 of the Code of Federal Regulations (CFR 47) (applicable to products fitted with USA modems)**

Your modem complies with Part 68 of the Code of Federal Regulations (CFR47) rules. On the computer or modem card is a label that contains the CFR 47 registration number and Ringer Equivalence Number (REN) for this device. If requested, this information must be provided to the telephone company.

A telephone line cord with a modular plug is required for use with this device. The modem is designed to be connected to the telephone network or premises wiring using a compatible modular jack which is Part 68 compliant. See installation instructions for details.

The Ringer Equivalence Number (REN) is used to determine the number of devices which may be connected to the telephone line. Excessive RENs on a telephone line may result in the devices not ringing in response to an incoming call. In most areas, the sum of RENs should not exceed five (5.0). To be certain of the number of devices that may be connected to a line, as determined by the total RENs, contact the local telephone company.

If this device causes harm to the telephone network, the telephone company will notify you in advance that temporary discontinuance of service may be required. The telephone company may request that you disconnect the equipment until the problem is resolved.

The telephone company may make changes in its facilities, equipment, operations, or procedures that could affect the operation of this equipment. If this happens, the telephone company will provide advance notice in order for you to make necessary modifications to maintain uninterrupted service.

This equipment cannot be used on telephone company-provided coin service. Connection to party line service is subject to state tariffs. Contact the state public utility commission or public service commission for information.

When programming or making test calls to emergency numbers:

- Remain on the line and briefly explain to the dispatcher the reason for the call.
- Perform such activities in the off-peak hours such as early morning or late evenings.

The United States Telephone Consumer Protection Act of 1991 makes it unlawful for any person to use a computer or other electronic device to send any message via a telephone fax machine unless such message clearly contains, in a margin at the top or bottom of each transmitted page or on the first page of the transmission, the date and time it is sent, an identification of the business, other entity, or other individual sending the message, and the telephone number of the sending machine or such business, other entity, or individual. Refer to your fax communication software documentation for details on how to comply with the fax-branding requirement.

## **Canada**

### **Industry Canada (IC)**

#### **Intentional emitter per RSS 210**

Your system may have a wireless keyboard and mouse included with it. The power and frequency range associated with these devices do not have the RF exposure concerns as with other wireless products.

Additional limitations, cautions, and concerns for specific countries are listed in the specific country sections (or country group sections). The wireless devices with your system are only qualified for use in the countries identified by the Radio Approval Marks on the device approval rating label. If the country you will be using the wireless device in, is not listed, please contact your local Radio Approval agency for requirements. Wireless devices are closely regulated and use may not be allowed.

The power output of the wireless device or devices that may be with your computer is well below the RF exposure limits as known at this time. Because these wireless devices emit significantly less energy than is allowed in radio frequency safety standards and recommendations, Gateway believes these devices are safe for use.

The wireless devices installed in this system are intended to be used indoors. In some areas, use of these devices outdoors is prohibited.

The wireless keyboard and mouse that may be shipped with your system operate in the frequency band of 49.825 to 49.895 MHz with RF output power of less than 30 Microwatts Effective Isotropic Radiated Power (EIRP).

Channel 1: 49,825,000 Hz, Channel 2: 49,835,00 Hz, Channel 3: 49,845,00 Hz, Channel 4: 49,855,000 Hz, Channel 5: 49,865,00 Hz, Channel 6: 49,875,00 Hz, Channel 7: 49,885,000 Hz, and Channel 8: 49,895,000 Hz.



### Warning:

Radio frequency wireless communication can interfere with equipment on commercial aircraft. Current aviation regulations require wireless devices to be turned off while traveling in an airplane. Do not use wireless devices at any time onboard a commercial aircraft. To minimize the possibility of interference, power off the wireless keyboard and mouse to ensure the device remains off during flight.



### Warning:

In environments where the risk of interference to other devices or services is harmful or perceived as harmful, the option to use a wireless device may be restricted or eliminated. Airports, Hospitals, and Oxygen or flammable gas laden atmospheres are limited examples where use of wireless devices may be restricted or eliminated. When in environments where you are uncertain of the sanction to use wireless devices, ask the applicable authority for authorization prior to use or turning on the wireless device.



### Warning:

Do not operate wireless devices unless all covers and shields are in place and the system or device is fully assembled.



### Warning:

Wireless devices are not user serviceable. Do not modify them in any way. Modification to a wireless device will void the authorization to use it. Contact Gateway for service.



### Warning:

The transmitting device may not be used with any antenna other than the antenna provided with them.

Operation of this device is subject to the following two conditions: (1) This device may not cause harmful interference, and (2) this device must accept any interference received, including interference that may cause undesired operation of the device.

### Unintentional emitter per ICES-003

This digital apparatus does not exceed the Class B limits for radio noise emissions from digital apparatus as set out in the radio interference regulations of Industry Canada.

Le présent appareil numérique n'émet pas de bruits radioélectriques dépassant les limites applicables aux appareils numériques de Classe B prescrites dans le règlement sur le brouillage radioélectrique édicté par Industrie Canada.

### Telecommunications per Industry Canada CS-03 (for products fitted with an IC-compliant modem)

The Industry Canada label identifies certified equipment. This certification means that the equipment meets certain telecommunications network protective, operation, and safety requirements. The Department does not guarantee the equipment will operate to the users' satisfaction.

Before installing this equipment, users should make sure that it is permissible to be connected to the facilities of the local telecommunications company. The equipment must also be installed using an acceptable method of connection. In some cases, the inside wiring associated with a single-line individual service may be extended by means of a certified connector assembly. The customer should be aware that compliance with the above conditions may not prevent degradation of service in some situations.

Repairs to certified equipment should be made by an authorized Canadian maintenance facility designated by the supplier. Any repairs or alterations made by the user to this equipment, or equipment malfunctions, may give

the telecommunications company cause to request the user to disconnect the equipment.

Users should make sure, for their own protection, that the electrical ground connections of the power utility, telephone lines, and internal metallic water pipe system, if present, are connected together. This precaution may be particularly important in rural areas.



#### Warning:

To avoid electrical shock or equipment malfunction do not attempt to make electrical ground connections by yourself. Contact the appropriate inspection authority or an electrician, as appropriate.

The **Ringer Equivalence Number (REN)** assigned to each terminal device provides an indication of the maximum number of terminals allowed to be connected to a telephone interface. The termination on an interface may consist of any combination of devices subject only to the requirement that the sum of the Ringer Equivalence Numbers of all the devices does not exceed 5.

## Mexico

### Unintentional emitter

At this time there are no mandatory requirements for Unintentional Emitters. However, this device does comply with multiple requirements for other countries and regions as listed on the system label and in the user's manual.

# Television antenna connectors protection

## External television antenna grounding

If an outside antenna or cable system is to be connected to your receiver, make sure that the antenna or cable system is electrically grounded to provide some protection against voltage surges and static charges.

Article 810 of the National Electrical Code, ANSI/NFPA 70, provides information with regard to proper grounding of the mast and supporting structure, grounding of the lead-in wire to an antenna discharge unit, size of grounding conductors, location of antenna discharge unit, connection to grounding electrodes, and requirements for the grounding electrode.

## Lightning protection

For added protection of any Gateway product during a lightning storm or when it is left unattended or unused for long periods of time, unplug the product from the wall outlet and disconnect the antenna or cable system.

## Power lines

Do not locate the antenna near overhead light or power circuits, or where it could fall into such power lines or circuits.



### Warning:

When installing or realigning an outside antenna system, extreme care should be taken to keep from touching such power lines or circuits. Contact with them could be fatal.

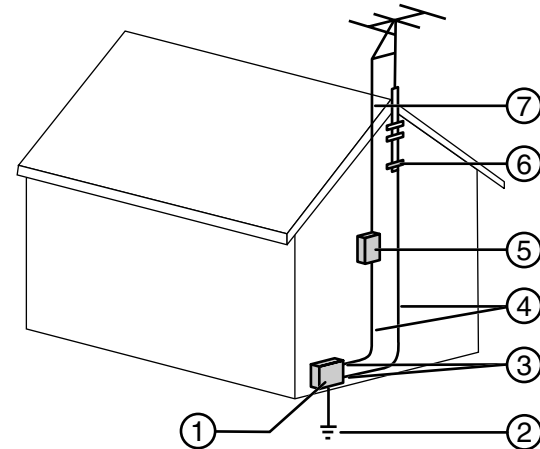

Reference	Grounding component
1	Electric service equipment
2	Power service grounding electrode system (NEC Art 250, Part H)
3	Ground clamps
4	Grounding conductors (NEC Section 810-21)
5	Antenna discharge unit (NEC Section 810-20)
6	Ground clamp
7	Antenna lead-in wire

# Laser safety statement

All Gateway systems equipped with CD and DVD drives comply with the appropriate safety standards, including IEC 825. The laser devices in these components are classified as “Class 1 Laser

Products” under a US Department of Health and Human Services (DHHS) Radiation Performance Standard. Should the unit ever need servicing, contact an authorized service location.



## Warning:

Use of controls or adjustments or performance of procedures other than those specified in this manual may result in hazardous radiation exposure. To prevent exposure to laser beams, do not try to open the enclosure of a CD or DVD drive.

# Macrovision statement

**If your computer has a DVD drive and an analog TV Out port, the following paragraph applies:**

This product incorporates copyright protection technology that is protected by method claims of certain U.S. patents and other intellectual property rights owned by Macrovision Corporation and other rights owners. Use of this copyright protection technology must be authorized by Macrovision Corporation, and is intended for home and other limited viewing uses only unless otherwise authorized by Macrovision Corporation. Reverse engineering or disassembly is prohibited.

# California Proposition 65 Warning



## Warning:

This product contains chemicals, including lead, known to the State of California to cause cancer, birth defects, or other reproductive harm.



# Notices

Copyright © 2003 Gateway, Inc.  
All Rights Reserved  
14303 Gateway Place  
Poway, CA 92064 USA

## All Rights Reserved

This publication is protected by copyright and all rights are reserved. No part of it may be reproduced or transmitted by any means or in any form, without prior consent in writing from Gateway.

The information in this manual has been carefully checked and is believed to be accurate. However, changes are made periodically. These changes are incorporated in newer publication editions.

Gateway may improve and/or change products described in this publication at any time. Due to continuing system improvements, Gateway is not responsible for inaccurate information which may appear in this manual. For the latest product updates, consult the Gateway Web site at [www.gateway.com](http://www.gateway.com). In no event will Gateway be liable for direct, indirect, special, exemplary, incidental, or consequential damages resulting from any defect or omission in this manual, even if advised of the possibility of such damages.

In the interest of continued product development, Gateway reserves the right to make improvements in this manual and the products it describes at any time, without notices or obligation.

## Trademark Acknowledgments

1-800-GATEWAY, ActiveCPR, ALR, AnyKey, black-and-white spot design, CrystalScan, Destination, DestiVu, EZ Pad, EZ Point, Field Mouse, Gateway 2000, Gateway Country, gateway.net, Gateway stylized logo, Perfect Scholar, Solo, TelePath, Vivitron, stylized "G" design, and "You've got a friend in the business" slogan are registered trademarks and black-and-white spotted box logo, GATEWAY, Gateway Astro, Gateway@Work, Gateway Connected touch pad, Gateway Connected music player, Gateway Cyber:)Ware, Gateway Education:)Ware, Gateway Flex Case, Gateway Gaming:)Ware, Gateway GoBack, Gateway Gold, Gateway Learning:)Ware, Gateway

Magazine, Gateway Micro Server, Gateway Money:)Ware, Gateway Music:)Ware, Gateway Networking Solutions, Gateway Online Network (O.N.) solution, Gateway Photo:)Ware, Gateway Professional PCs, Gateway Profile, Gateway Solo, green stylized GATEWAY, green stylized Gateway logo, Gateway Teacher:)Ware, Gateway Video:)Ware, HelpSpot, InforManager, Just click it!, Learn@Gateway, Kids BackPack, SERVE-TO-ORDER, Server Watchdog, the Spotted G Gateway Logo and the Spotted G Logo, SpotShop, Spotshop.com, and Your:)Ware are trademarks of Gateway, Inc. Intel, Intel Inside logo, and Pentium are registered trademarks and MMX is a trademark of Intel Corporation. Microsoft, MS, MS-DOS, and Windows are trademarks or registered trademarks of Microsoft Corporation. All other product names mentioned herein are used for identification purposes only, and may be the trademarks or registered trademarks of their respective companies.





MAN FMC 901 USR GDE R0 11/03



8509636

## Free Manuals Download Website

<http://myh66.com>

<http://usermanuals.us>

<http://www.somanuals.com>

<http://www.4manuals.cc>

<http://www.manual-lib.com>

<http://www.404manual.com>

<http://www.luxmanual.com>

<http://aubethermostatmanual.com>

Golf course search by state

<http://golfingnear.com>

Email search by domain

<http://emailbydomain.com>

Auto manuals search

<http://auto.somanuals.com>

TV manuals search

<http://tv.somanuals.com>