

GRACO®

Easy-Entry™ Battery Swing

OWNER'S MANUAL

Model No. _____
Serial No. _____

Dear Customer,

Please fill in the model and serial numbers above from the label beneath the motor of your new swing.

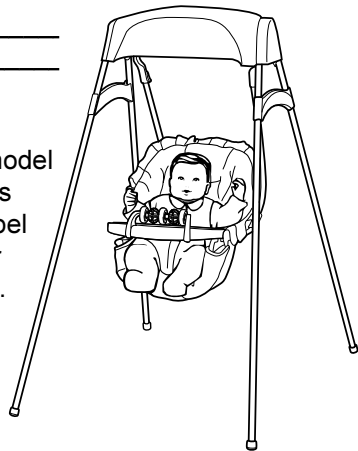

Model No. 1602

Congratulations on your purchase of a Graco® swing!

Graco is the recognized leader in the design and manufacture of quality baby swings. We believe your new Graco® swing is a wise choice, promising many hours of enjoyment for your baby.

Before using your swing, please take a few minutes to read this Owner's Manual. The short time you spend reading these instructions will help you use your swing properly.

Please save your Owner's Manual for future use.

Customer Satisfaction

Our goal is to make every product the best it can be! We are also committed to supporting our products after purchase. If you would like to speak with Graco about your product, please contact our **Customer Service Department at 1-800-345-4109** or visit our Internet website, www.gracobaby.com. Our knowledgeable staff will be ready to answer any questions you may have concerning parts, use or maintenance. When you call, please have the **model and serial numbers** ready so your call may be processed quickly and efficiently.

⚠ WARNING

Failure to follow these warnings could result in serious injury or death.



**Never leave child unattended.
Always keep your child in view.**



**Strings can cause strangulation.
DO NOT place items with a string around your child's neck, such as hood strings or pacifier cords.
DO NOT suspend strings over the swing or attach strings to toys.**

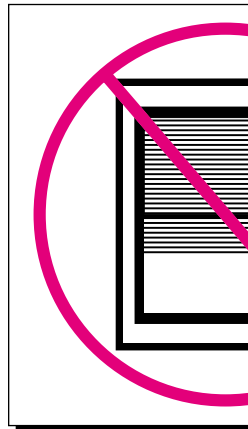

**STRANGULATION HAZARDS
DO NOT place items in locations where the child could become entangled, such as window blinds, drapes, phone cords, etc.**

THIS PRODUCT REQUIRES ADULT ASSEMBLY.

FOLLOW ASSEMBLY INSTRUCTIONS CAREFULLY.

If you experience any difficulties, please contact the Customer Service Department.

DO NOT USE SWING without the seat cover.

DISCONTINUE USING YOUR SWING should it become damaged or broken.

WARNING

Read the instructions and the assembly instructions carefully to avoid serious injury or death.

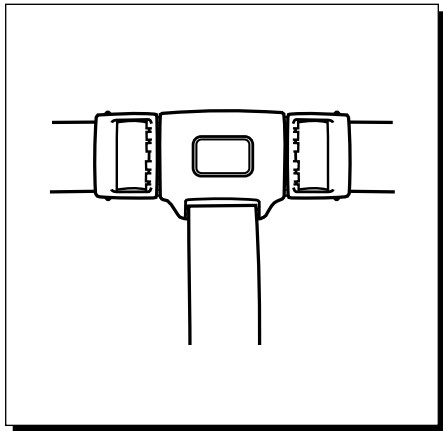

Avoid serious injury from falling or sliding out. Always use seat belt.



ATTENTION HAZARD: Do not use the swing in any area where there are cords, power cords, low blind cords, or other cords, etc.



DO NOT use if child weighs over 25 pounds (11.3 kg) or becomes too active to safely use the swing.

CARE AND MAINTENANCE

FROM TIME TO TIME CHECK YOUR SWING for loose screws, worn parts, torn material or stitching. Replace or repair the parts as needed. Use only Graco® replacement parts.

REMOVABLE CLOTH SEAT COVER may be machine washed in lukewarm water on delicate cycle and drip-dried. **NO BLEACH.**

TO CLEAN SWING FRAME, use only household soap or detergent and warm water. **NO BLEACH.**

EXCESSIVE EXPOSURE to sun or heat could cause fading or warping of parts.

PARTS LIST

CHECK that you have all the parts listed below BEFORE assembling your swing. If any parts are missing, call Customer Service at 1-800-345-4109 or visit our Internet website, www.gracobaby.com.

Tool required: Screwdriver

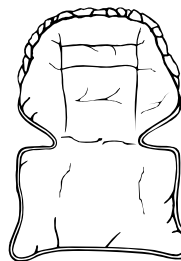

Seat cover

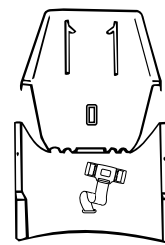

Plastic seat with crotch strap

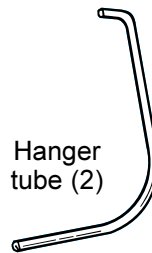

Hanger tube (2)



Motor unit

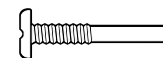

Pin screw (2)



Seat belt

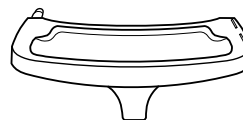

Tray

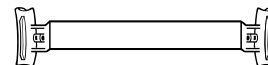

Back brace

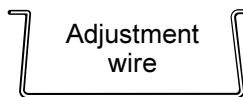

Adjustment wire



Toy mount cover (2)



Leg brace (2)



Plastic tip (4)

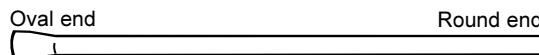

Upper leg section (4)

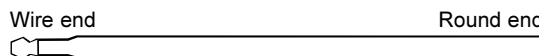

Lower leg section (4)

Attaching the Legs

Step 1.

Push **oval** end of the upper leg sections firmly onto the four plastic pegs. Hold tube vertically while pushing in. **Push leg on completely.**

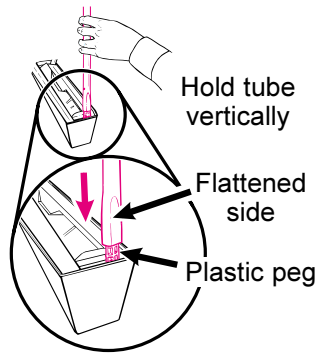

Step 2.

Push the leg tips on the round ends of the lower leg sections. (The other ends have a wire.)

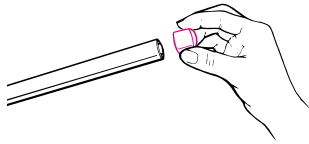

Step 3.

Put the wire end of lower leg sections into the **round** end of the upper leg sections. Push the sections together while twisting lower leg slightly. This will ensure a snug fit.

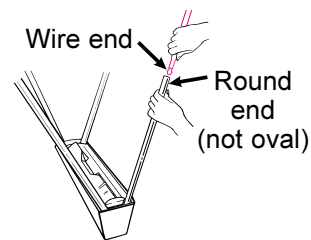

Step 4.

CHECK:
Lift swing as shown. If legs are assembled properly, the legs will dangle from the motor unit and not fall off.

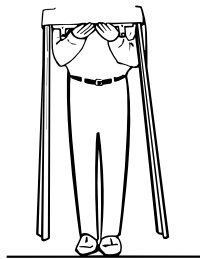

IF LEG FALLS:
Holding leg vertically, push leg firmly up while pushing the motor unit down.

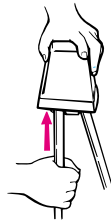

Step 5.

Open the swing legs completely. Snap plastic leg braces onto outside of legs. The plastic pins inside the ends of the braces will fit into the dimples on the legs.

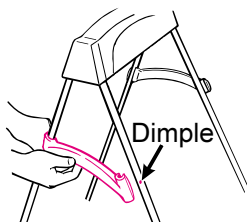

It may be necessary to spread the legs as shown.

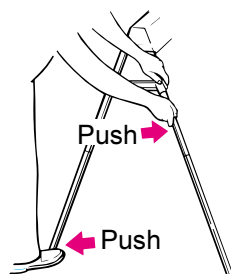

▲ WARNING Do not use swing without the leg braces.

Attaching the Hanger Tubes and Seat

Step 1.

Move seat back fully forward onto seat armrests.

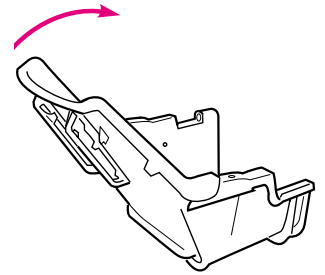

The seat back must overlap the armrests.

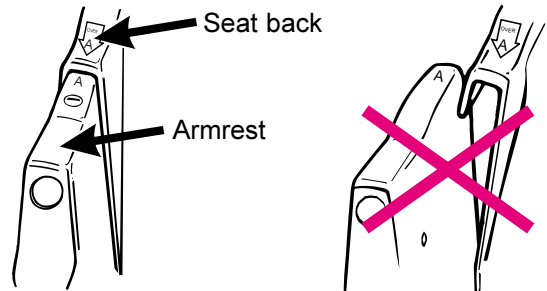

Step 2.

Slide hanger tubes into armrests of seat as shown.

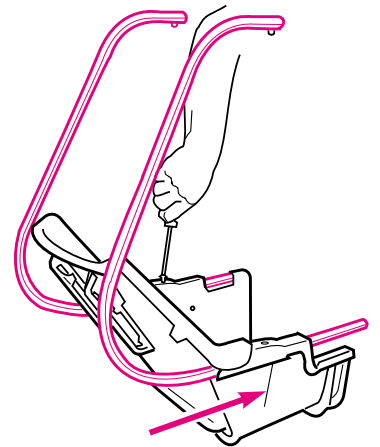

Step 3.

Insert two pin screws through seat armrests into the holes in the hanger tubes and tighten securely.

Step 4.

Insert the hanger tubes into the hanger brackets as shown. Metal buttons should pop out and lock upon full insertion.

CHECK that the hanger tubes are secure in hanger brackets by pulling firmly on them.

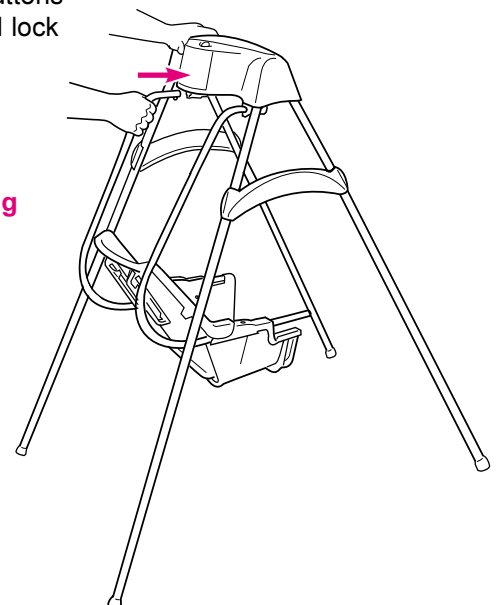

Attaching the Back Brace

Working behind the seat, snap the four pins in the ends of the plastic back brace into the holes in the hanger tubes.

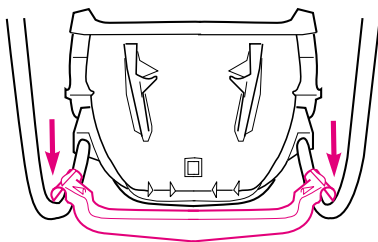

Slide adjustment wire through openings in seat back, then insert ends into back brace holes as shown.

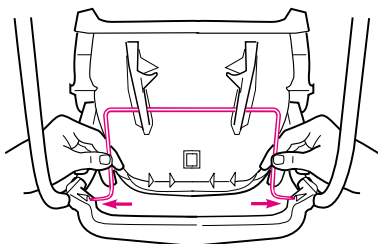

Be sure the back brace is securely attached by pulling on it.

Attaching the Tray

Place one hand on the armrest and slide the tray onto the hanger tube with other hand. Push sleeve of tray all the way into the armrest of the seat until you hear it snap.

Sleeve on tray must snap completely into the armrest.

Pull firmly on tray to be sure it is securely attached.

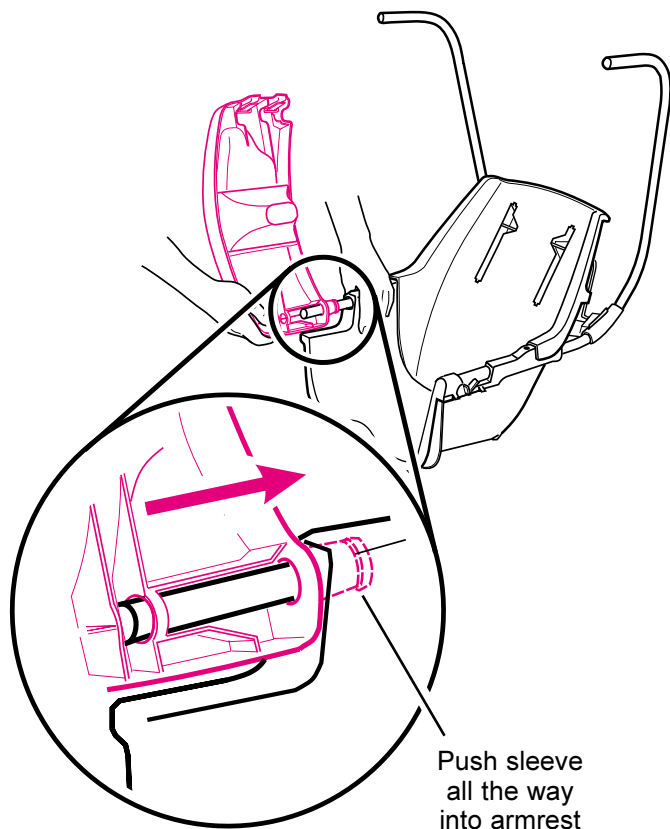

Attaching the Seat Belt

Step 1.

Thread one end of the seat belt through the belt retainer as shown.

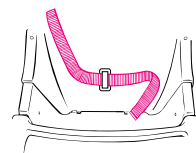

Step 2.

Thread both ends of seat belt through the buckles as shown.

CHECK that the belt is threaded correctly by pulling on the seat belt. **The belt should not slip through the buckle.**



To release, push in on front of buckle.

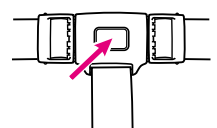

Attaching the Seat Cover

Step 1.

Slide the pocket of the seat cover over the top of the seat as shown.

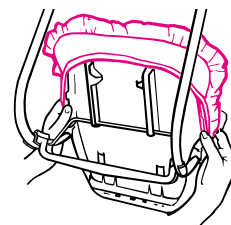

Step 2.

Pull crotch strap and both ends of the seat belt through the slots in the seat cover.

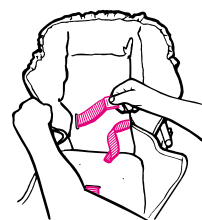

Step 3.

Push the elastic loop through the hole on one side of seat.

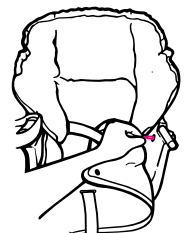

Step 4.

Fold cover around bottom of seat. Then fasten the hook into the elastic loop on one side as shown. Repeat on other side.

CAUTION: Be sure the seat cover at armrest does not interfere with tray latching.

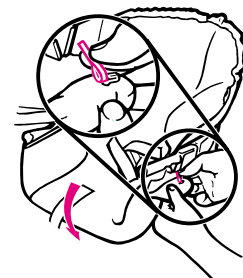

Toy Mounting System

Your swing has a toy mounting system in the tray. This swing model does not come equipped with toys. If you would like to order toys, please see the enclosed leaflet for information. Please insert the two plastic covers as described below to fill the holes in the tray.

To Install Covers

To insert a cover into the tray of your swing, first push one side into a notch, then push in the other side.

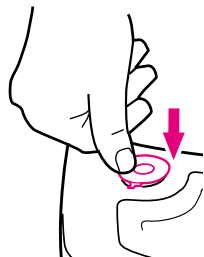

Using the Tray

If tray does not latch, check back brace to be sure the word "REAR" is away from the seat.

Step 1.

Unlatch the tray by squeezing the two latches under the tray at the same time, and lift up the tray. **Be careful** not to let the tray hit your baby when lifting or closing the tray.

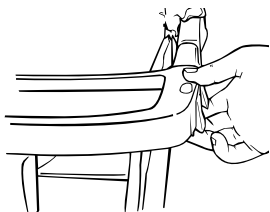

Step 2.

To latch tray, push down firmly.

▲ WARNING Tray must be latched at all times when baby is in the swing. Pull up on tray to be sure it is latched.

Reclining Back— Four Positions

Pull adjustment wire upward and pull seat backward to recline seat. Extra pressure is needed to go from third position to full recline.

For upright position, simply lift back of seat forward.

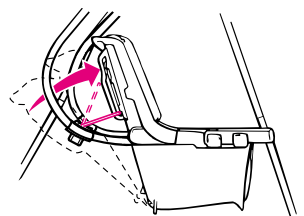
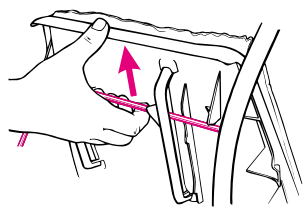

Installing Batteries

▲ WARNING NEVER INSERT OR REMOVE THE BATTERIES WITH BABY IN THE SEAT. THEY COULD FALL ON BABY IF DROPPED!

Step 1.

With baby out of swing, open the battery compartment by gently pressing on the lid at the ridged area and lifting the lid.

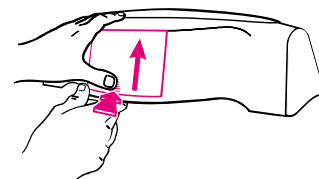

Step 2.

Insert four "D" cells. **CHECK** that the batteries are put in correctly. (Swing will not run if batteries are put in backwards.)



Step 3.

Snap the lid closed.

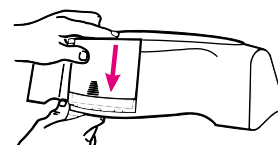

Starting Swing

CHECK that all parts are securely fastened together before using the swing.

Step 1.

Open tray and seat belt. Place baby in the seat. (If your child is very small, you may want to use rolled-up blankets as a prop.)

Step 2.

Place crotch strap between child's legs and snap both side buckles to the center buckle. Adjust belt as needed to get a snug fit around your child.

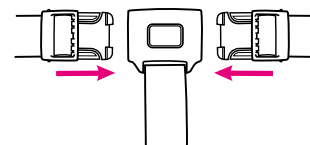

Step 3.

Close the tray. **CHECK that tray is latched by lifting up on the tray.**

▲ WARNING Do not depend on the tray or seat belt alone to hold your baby. Always secure your baby with both the seat belt and tray when your baby is in the swing.



Step 4.

Adjust the control switch to medium setting.

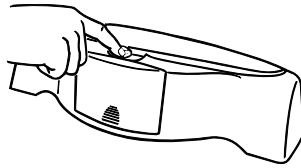

Step 5.

PUSH SWING SEAT TO START. BE SURE YOU PUSH IT UP HIGH ENOUGH FOR THE MOTOR TO GET A GOOD START.

Observe the swinging motion for a minute. It takes time for your swing to adjust to a new setting.

- For a lower speed, push the control switch toward “low.”
- For a higher speed, push the control switch toward “high.”

A small, quiet baby will swing higher on each setting than a larger, more active baby.

Indicator Light-
ON/OFF light comes on
when swing is turned on.

Your seat may be stopped at any time the motor is running without damaging the motor. Push swing to restart.

If your swing motor stops operating by itself, a protective device may have been activated. Turn off motor, wait three minutes, then restart swing.

FOR SAFE BATTERY USE:

Do not remove or insert the batteries with baby in swing. The batteries could fall on baby if dropped.



Keep the batteries out of children's reach.

Any battery may leak battery acid if mixed with a different battery type, if inserted incorrectly (put in backwards) or if all batteries are not replaced or recharged at the same time.



Any battery may leak battery acid or explode if disposed of in fire or an attempt is made to charge a battery not intended to be recharged. Never recharge a battery of one type in a recharger made for a battery of another type.

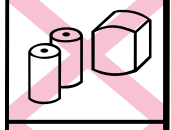

Discard leaky batteries immediately. Leaky batteries can cause skin burns or other personal injury. When discarding batteries, be sure to dispose of them in the proper manner, according to your state and local regulations.



Always remove batteries if the swing is not going to be used for a month or more. Batteries left in the unit may leak and cause damage.

Recommended Type Batteries—Size D

- Rechargeables—Use and recharge according to manufacturer's instructions.
- Disposables—Alkaline.
- **NEVER** mix battery types.

Change batteries when swing ceases to operate satisfactorily.

Caring for Your Battery Powered Swing

Problem: Possible Reasons for Problem:

- | | |
|---------------------|---|
| Swing won't operate | <ol style="list-style-type: none">1. No batteries in swing.2. Batteries dead.3. Speed setting too low.4. Batteries in backwards—check “+” and “-”.5. Corrosion on battery terminals. Rotate batteries in place against terminals, or clean with sandpaper or steel wool if corrosion is severe.6. Baby leaning too far forward.7. Baby grabbing swing legs. (Discontinue use.)8. Seat not pushed high enough for a good start.9. Protective device activated. (Turn off motor, wait 3 minutes, then restart swing.) |
|---------------------|---|

- | | |
|------------------------------|--|
| Seat doesn't swing very high | <ol style="list-style-type: none">1. Control setting too low.2. Blanket hanging down, causing increased wind resistance.3. Batteries too weak.4. Baby leaning too far forward.5. Baby too heavy or too active. (Discontinue use.)6. Soft carpet (swings higher on hard floors). |
|------------------------------|--|

If you still have problems, call our toll-free number, 1-800-345-4109.

Replacement Parts

Instructions for ordering swing parts:

Complete form below. Your swing model number **MUST** be included on the form to ensure proper replacement parts. **Your model number can be found on a sticker beneath the swing motor. Payment must accompany your order.**

Parts List:	Price:*
Motor unit.....	\$25.00
Hanger tube	\$13.00 (each)
Plastic seat.....	\$20.00
with strap & buckle	
Cloth seat cover.....	\$14.00
Seat belt	\$ 5.00
Hardware.....	\$ 5.00
Plastic leg brace.....	\$ 5.00 (each)
Adjustment wire.....	\$ 7.00
Back brace.....	\$ 7.00
Upper leg section.....	\$ 7.00 (each)
Lower leg section.....	\$ 7.00 (each)
Leg tips (set of 4).....	\$ 5.00
Tray.....	\$12.00

* Prices subject to change without notice.

IF YOU NEED HELP

If you have any questions or if you need any part not listed, please call toll-free:

1-800-345-4109

or visit our Internet website, www.gracobaby.com.

Return the form below with payment to:

**GRACO CHILDREN'S PRODUCTS INC.
CUSTOMER SERVICE DEPARTMENT
P. O. BOX 100, MAIN STREET
ELVERSON, PA 19520**

Model Number	SHIP TO:
(Must be filled in)	Name _____
<input type="checkbox"/> Motor unit	Address _____
<input type="checkbox"/> Hanger tube	City, State, Zip _____
<input type="checkbox"/> Plastic seat with strap & buckle	() _____
<input type="checkbox"/> Cloth seat cover	Telephone _____
<input type="checkbox"/> Seat belt with buckle	
<input type="checkbox"/> Hardware	<input type="checkbox"/> Check enclosed
<input type="checkbox"/> Plastic leg brace	(payable to Graco Children's Products Inc.)
<input type="checkbox"/> Adjustment wire	<input type="checkbox"/> Charge to credit card:
<input type="checkbox"/> Back brace	<input type="checkbox"/> Visa
<input type="checkbox"/> Upper leg section	<input type="checkbox"/> MasterCard
<input type="checkbox"/> Lower leg section	<input type="checkbox"/> Discover
<input type="checkbox"/> Leg tips (set of 4)	
<input type="checkbox"/> Tray	
Total: _____	Account #: _____
Shipping & handling: <u>\$5.00</u>	Expiration date: _____
6% sales tax (PA only): _____	Signature: _____
Total amount due: _____	

Free Manuals Download Website

<http://myh66.com>

<http://usermanuals.us>

<http://www.somanuals.com>

<http://www.4manuals.cc>

<http://www.manual-lib.com>

<http://www.404manual.com>

<http://www.luxmanual.com>

<http://aubethermostatmanual.com>

Golf course search by state

<http://golfingnear.com>

Email search by domain

<http://emailbydomain.com>

Auto manuals search

<http://auto.somanuals.com>

TV manuals search

<http://tv.somanuals.com>