



GRAVELLY

**CONVERTIBLE
7.6**

**OWNERS
MANUAL**

GRAVELLY

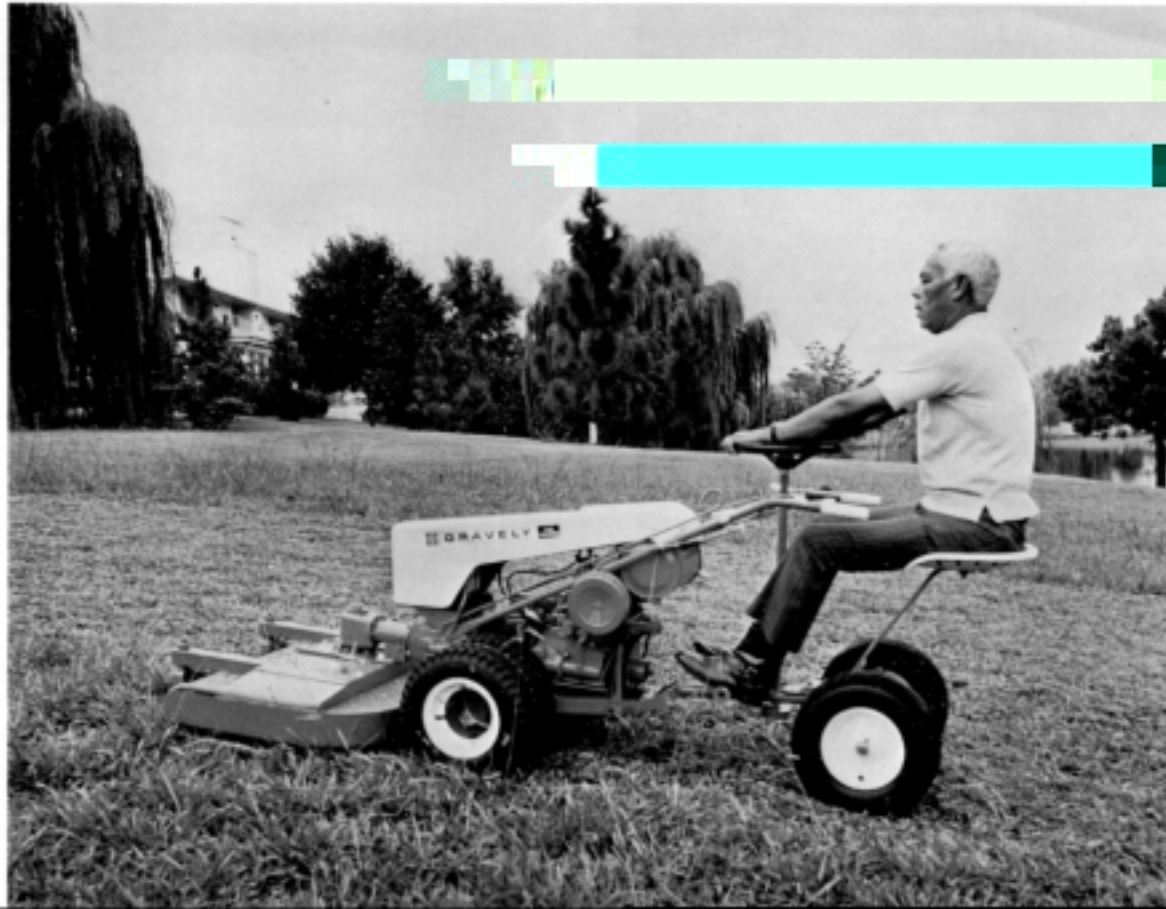

THANK YOU for your investment in Gravely equipment. It is an investment, for the Gravely will save you work and worry for many years.

You will gain still greater satisfaction from your Gravely if you add the tools you need for your other jobs. From time to time we suggest you consult your dealer for the many Gravely attachments that will eliminate grounds upkeep and garden drudgery.

Your Gravely Tractor and attachments are warranted under terms shown herein. To qualify for this Warranty, you must register your tractor by completing the enclosed Registration Card and returning it. For your own protection, please do this right away.

To continue its program of quality and design improvement, the manufacturer reserves the right to change specifications, design or prices without notice and without incurring obligations.

TABLE OF CONTENTS

| | |
|------------------------------|----|
| Safety Instructions | 3 |
| Introductions | 4 |
| Operation | 5 |
| Starting | 5 |
| Operating the Tractor | 6 |
| Maintenance | 7 |
| Specifications | 9 |
| Attachments | 10 |
| 30" Rotary Mower | 10 |
| 30" Rotary Mower Attachments | 11 |
| 40" Rotary Mower | 12 |
| Sickle Mower | 13 |
| Lawn Care | 14 |
| Twin Tool Gardening | 15 |
| Cultivator Toolholder | 17 |
| Snowblower | 18 |
| 48" Snowdozer | 19 |
| Steering Sulky | 20 |
| Riding Sulky | 20 |

SAFETY INSTRUCTIONS

TRAINING

1. Read the Instruction Manual carefully. Be thoroughly familiar with the controls and proper use of the equipment.
2. Never allow children to operate tractor.
3. Keep the area of operation clear of all persons, particularly small children and pets.

PREPARATION

1. Thoroughly inspect the area where the equipment is to be used, remove all foreign objects.
2. Do not operate equipment when barefoot or wearing open sandals.
3. Check fuel before starting engine. Do not fill gasoline tank indoors, when engine is running or while engine is still hot. Wipe off any spilled gasoline before starting engine.
4. Check to be sure PTO is disengaged and put Forward-Reverse and High-Low in neutral before starting engine.
5. Never attempt to make an adjustment on attachments while engine is running.
6. Operate only in daylight or in good artificial light.
7. Always be sure of your footing; keep a firm hold on the handles and walk; never run.

OPERATION

1. Do not change engine governor settings to overspeed engine.
2. Do not put hands or feet near or under rotating parts. Keep clear of discharge openings at all times.
3. Stop mower attachment when crossing gravel drive, walks or roads.
4. If a foreign object is struck, stop engine and thoroughly inspect the attachment and tractor for any damage, and repair the damage before restarting and operating the attachment.
5. If the equipment should start to vibrate abnormally, stop the engine and check immediately for the cause. Vibration is generally a warning of trouble.
6. Stop engine and wait until all moving parts have come to a complete stop before you leave the equipment.
7. When cleaning, repairing or inspecting, make certain all moving parts have stopped. Disconnect spark plug wire and keep wire away from plug to prevent accidental starting.
8. Do not run engine indoors without proper ventilation.
9. Exercise extreme caution when changing direction on slopes. Do not mow excessively steep slopes.

MAINTENANCE AND STORAGE

1. Keep all nuts, bolts, and screws tight to be sure equipment is in safe working condition.
2. Never store equipment with gasoline in the tank inside of a building where fumes may reach an open flame or spark. Allow engine to cool before storing in any enclosure.
3. Keep engine free of grass, leaves, debris, or excessive grease to prevent overheating and possible fire hazard.

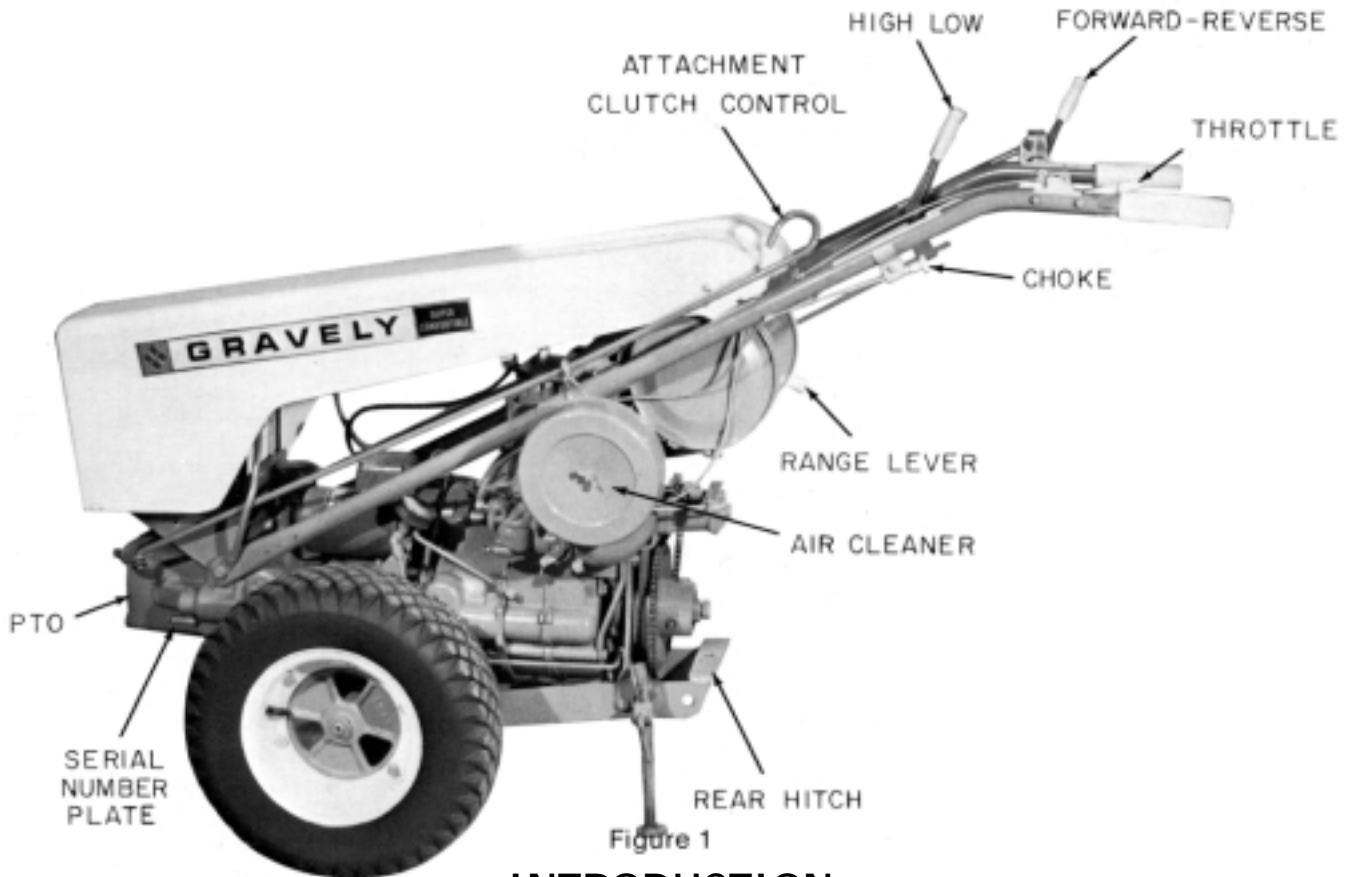

INTRODUCTION

The Gravelly Convertible 7.6 Tractor is available in two models - the Custom and the Super. The Super has the added feature of electric starter and governor.

The Convertible 7.6 Tractor is powered by a Gravelly engine producing 7.6 horsepower. All gear drive allows power to be transmitted directly from the engine to the power attachment by steel shafts and gears.

The Convertible 7.6 offers year-around, all-season versatility with many different attachments available. Out-front mounting of most attachments gives you maximum visibility and safety.

This tractor will give you highly satisfactory service if maintained and operated as outlined in this manual.

All references to Left Hand and Right Hand; front and rear are given from the operators position, as you stand behind the tractor.

For detailed service information, a service manual is available through your dealer or through the home office.

It is important that you know the Serial Number of your tractor. The Serial Number is located on the Left Hand side of the advance casting. See Figure 1. The serial number of your tractor is

For your future reference, please fill in your serial Number as soon as possible.

Please refer to this number on all correspondence concerning your tractor to expedite prompt response to your needs.

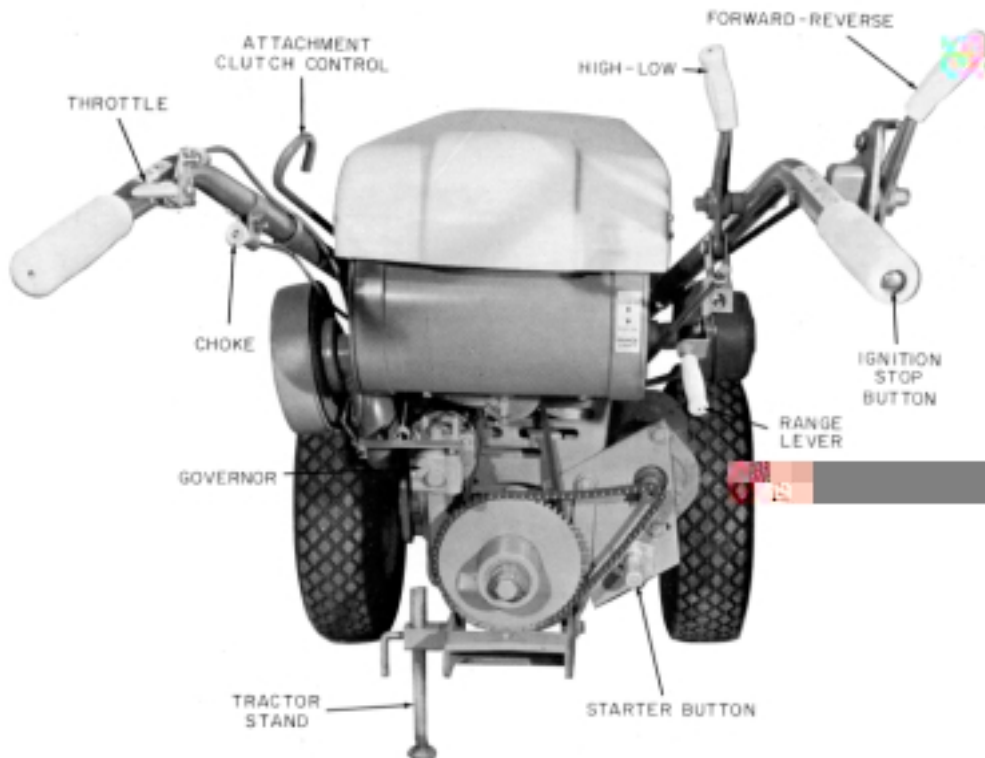

Figure 2

OPERATION

Throttle - Depress the throttle to accelerate engine, raise to decelerate engine.

Choke - Pull to choke; push forward fully for normal operation.

Operating Levers - The operating levers, one for high and low speeds and one for forward and reverse are located on the right tractor handle.

Range Control - On tractors with the optional eight speed transmission, the range selector lever is on the right by the fuel tank. Push forward fully for low range; pull rearward fully for high range.

Attachment Clutch Control - The attachment clutch control is the attachment clutch lever that enables you to engage or disengage the power attachment from your position at the tractor handles. Pull to engage the attachment; push to disengage.

Ignition Stop Button - To stop engine, depress the ignition stop button. Keep depressed until the engine stops completely.

STARTING

Whether you have a manual starter or an electric starter, before starting check to see if:

Operating levers are in neutral .

Attachment clutch control is in the disengaged position .

Valve on fuel tank is open and fuel in tank

Oil level is on full mark .

Throttle is open approximately half-way .

An attachment or attachment boss cover is secured to the front of the tractor.

Normal Starting - On tractors with the manual starter, attach the strap to the pulley (place the hole in the strap over the pin in the pulley groove) and wind the strap onto the pulley in the direction of the arrow on pulley. Pull the strap hard and fast. Choke as required. With the electric starter, simply press the starter button with your toe. Choke as required.

NOTE: In proper working order, the engine should start with one or two attempts (a few more may be necessary in cold weather). If it doesn't, check the Trouble Shooting section to find and correct the trouble. Do not tamper with the carburetor - this will serve only to complicate things, for even with the carburetor out of adjustment, the engine should start.

Cold Weather Starting - Cold weather starting troubles usually can be avoided if you:

Make sure the proper weight oil is used. Oils heavier than those recommended will stiffen at low temperature thus making starting more difficult .

Use fresh high quality regular grade gasoline .

Store the tractor in a heated building if possible.

OPERATING THE TRACTOR

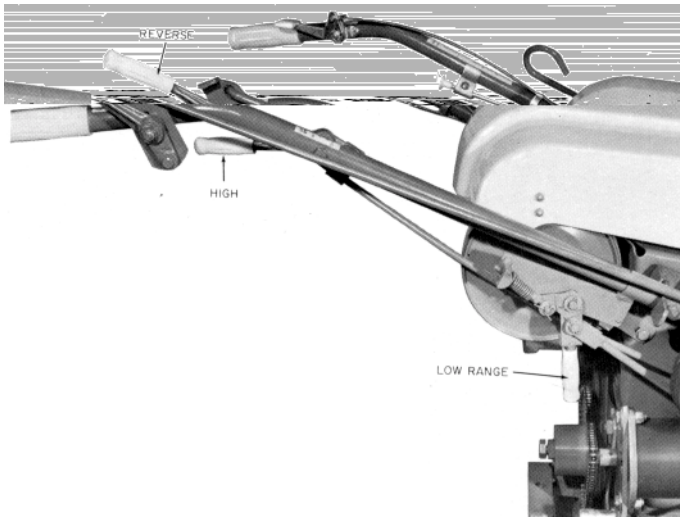

Figure 3

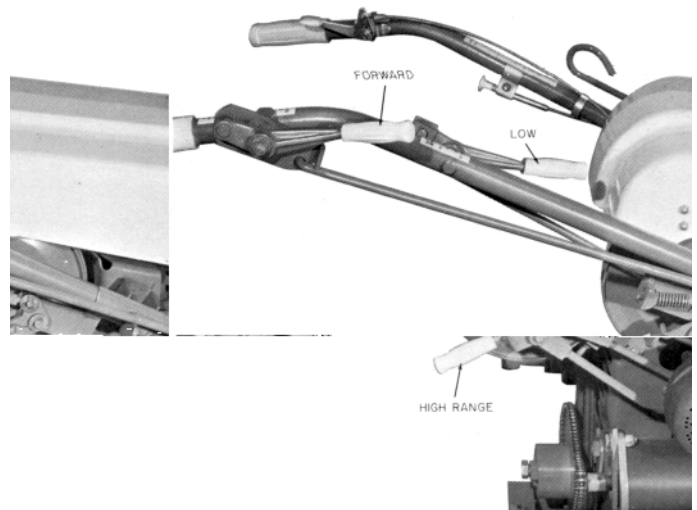

Figure 4

When starting the tractor, have high-low and forward-reverse control levers in neutral and the attachment clutch control pushed forward fully in the disengaged position.

If the tractor is the eight speed transmission model the Range Selection Lever should be in the position for the range in which the tractor will be operated initially.

Engaging wheels - To put tractor in motion, first move the high-low control lever to either the high or low position (figure 3). Then move the forward-reverse control lever into forward or reverse. Depress the throttle to the desired speed.

NOTE: WITH ONLY THE HIGH-LOW CONTROL LEVER IN HIGH OR LOW, THE TRACTOR WILL NOT MOVE.

Engaging Power Attachment - Before attempting to put a power attachment in gear, be sure that the tractor is stopped, with high-low and forward-reverse control in neutral and the engine running at idle speed.

After the attachment is engaged, increase the engine speed to about half-throttle. Move the high-low control lever to high or low.

Braking - The forward-reverse control lever is used as a brake when you must stop. Move the lever out of forward, pass through neutral, and apply pressure at reverse position -enough pressure to stop the forward motion of the tractor.

STANDARD TRANSMISSION - The standard transmission models have four speeds - high and low in forward and high and low in reverse. These speeds control both ground speed and attachment speed, with low gear having about 75% of the speed obtainable in high gear.

EIGHT-SPEED TRANSMISSION - The eight speed transmission models feature a two-speed axle giving the tractor four speeds forward and four speeds in reverse. Shifting the axle between high and low ranges controls only the tractor's ground speed. Shifting the high-low control lever between high and low provides a further control over ground speed as well as attachment speed.

To change axle ranges: Stop the tractor. Keep the high-low control lever in high or low, but move the forward-reverse control to neutral. Move the range selection lever to high or low range. Move the forward-reverse control lever back and forth slightly if necessary to allow the gears to mesh.

CAUTION: THIS SHIFT SHOULD ONLY BE MADE ON LEVEL GROUND.

Individual jobs will dictate the combination of axle range and gear to be used. In general, low axle range should be used for plowing, cultivating, snow blowing, heavy mowing, and other jobs where a slower ground speed is needed to give the attachment longer to do its job. High axle range generally is satisfactory for mowing and other lawn jobs.

Other Points - Don't slip the clutch. If you find the ground speed of the tractor too fast for the job, shift to a lower gear. If you can't shift any lower, take a smaller cut - one on which the attachment can do the job with the tractor fully in gear. Repeated clutch slipping causes undue wear and should be avoided.

STOPPING

To shut off the engine, depress ignition stop button (figure 2) after disengaging attachment and moving both operating levers to neutral.

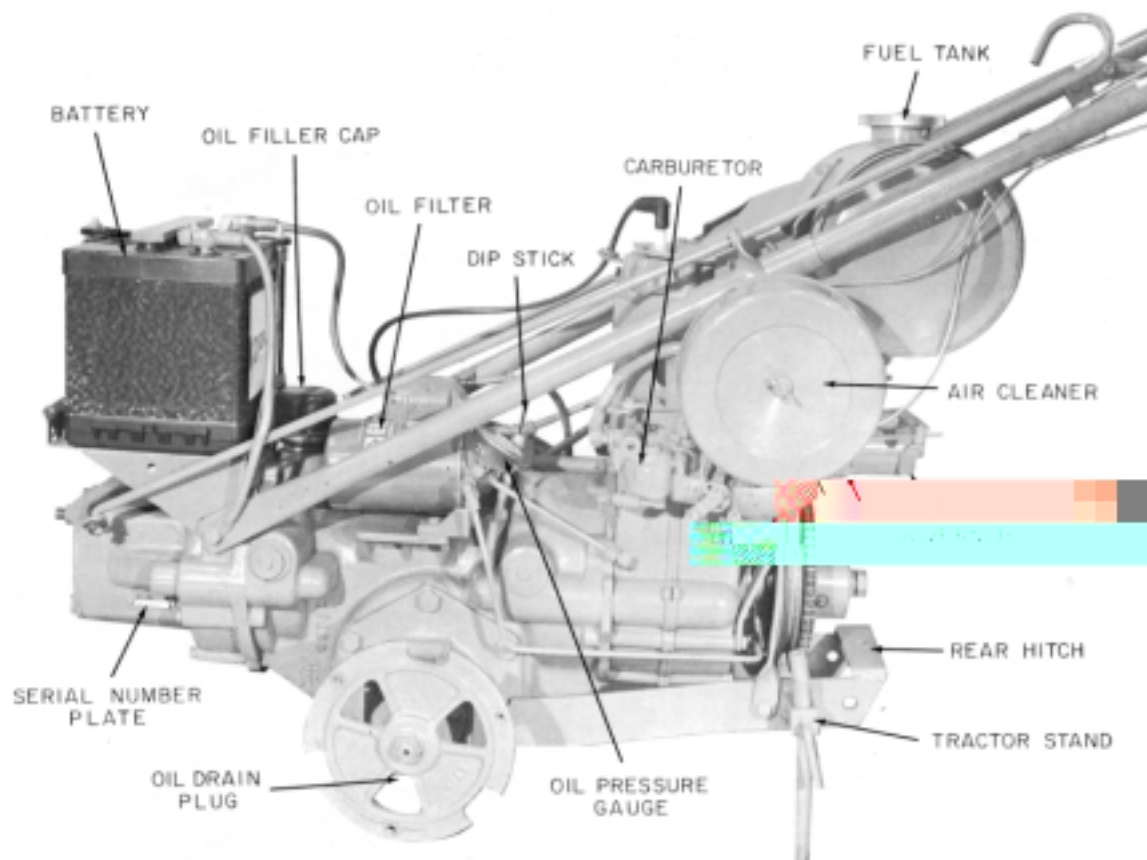

Figure 5

MAINTENANCE

LUBRICATION

Filling the chassis to its 5 pint (2.36L.) capacity with motor oil lubricates both the engine and transmission. Do not use transmission oil or grease. The following is recommended:

Summer - SAE 30 or SAE 10W-30. API Classification - SC or SD

Winter - (32 degrees F or below) SAE 10W or SAE 10W-30 API Classification - SC or SD

Oil Level - Regularly check the oil level with the Dipstick (figure 5) before starting. Be sure the tractor is level.

Add oil - Add oil by removing the Oil Filler Cap (Figure 5). Stop when the oil reaches the FULL mark on the dipstick. (Allow time for the oil to drain down prior to checking. This prevents overfilling.)

Oil Filler Cap - Periodically check the breather-type oil filler cap. Wash it in solvent at least every oil change.

Oil Changes - Change the oil after the initial eight hours of operation. Then change the oil every 40 hours under normal conditions, oftener under dusty conditions and/or periods of extended operation under heavy load.

Drain oil by removing the oil drain plug, the bottom bolt on the Left Hand axle housing.

Be sure oil drain washer is in place when replacing the bolt.

Oil Filter - Under normal conditions, change the oil filter every 80 hours, however, under extremely dusty conditions and/or extended operation under

heavy loads, change the oil filter every 40 hours.

The oil filter must be installed by hand. Install the filter following the instructions printed on the filter.

Oil Pressure - Check the oil pressure gauge when starting. The level should raise quickly after starting, and at full throttle be about 2/3 of the way over in the normal range. If the oil pressure is not correct, stop the engine and check oil level. If the oil level is not low, check your service manual or call your dealer.

Battery (Electric Start models only) - daily check the electrolyte level of the battery. Maintain at proper level by adding only distilled water.

AIR INTAKE SYSTEM

The importance of maintaining an air cleaner in proper condition cannot be over-emphasized! Dirt induced through improperly installed, improperly serviced elements, wears out more engines than does long hours 'of operation. Furthermore, operating with a clogged element causes a richer fuel mixture which can lead to formation of harmful sludge deposits. Always cover carburetor or air horn when air cleaner is removed for servicing.

Dry type air cleaner elements should be serviced only when required. Need for air cleaner service is evident by a loss of power for no apparent reason.

To clean, remove element and tap lightly on a flat surface to remove loose surface dirt. Replace element if dirt does not drop off easily or if the element is

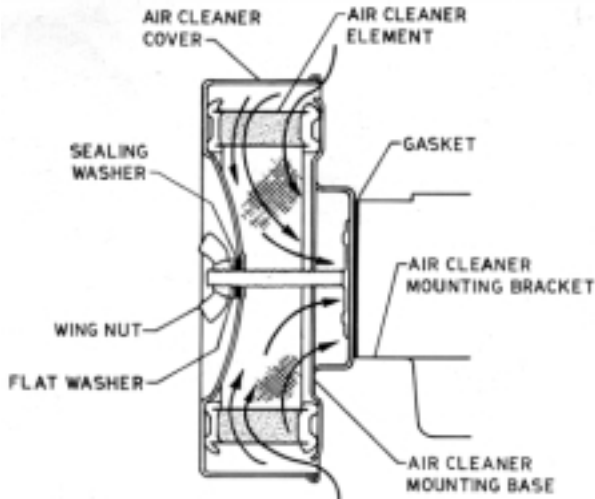

Figure 6

damaged in any way. Also, replace element if there is any evidence of dirt on the inside surface of the element.

DO NOT wash dry elements in any liquid or attempt to blow dirt off with air hose as this will puncture the filter element.

Handle new element carefully - do not use if the gasket surfaces are bent, twisted, or damaged in any way. Use only genuine Gravelly elements. Use of other elements will void warranty. Not only must the proper element be used but it must be properly installed to prevent unfiltered air from entering the engine.

Install the air cleaner assembly in this sequence on the air cleaner mounting bracket:

1. Rubber gasket
2. Air cleaner mounting base
3. Element
4. Air cleaner cover
5. Rubber sealing washer
6. Flatwasher
7. Wing Nut

Be sure the element gasket surfaces fit tightly on the base and cover. The wing nut should be finger tight.

Fuel - Use a good grade of regular gas. Premium grade should not be used. Fuel tank capacity is approximately 1 3/4 gallons (6.63 L.).

It is good practice to periodically clean the tractor. Dirt accumulation on tractor allows heat buildup.

Troubleshooting

Fuel Troubles - Check to see if:

-Fuel tank contains fuel
-Vent hole in fuel tank cap is open
-Fuel shut off valve is open. (Turn counterclockwise to open)
-Fuel line is clear. Close shutoff valve. Remove fuel line from carburetor, and reopen valve. If fuel flows, the line is clear; if not, check the fuel hose and fittings, and strainer in fuel tank .
-Carburetor is getting fuel. With the fuel line intact, close the shut-off valve. Drain any fuel remaining in the carburetor by removing the plug from the bottom of the carburetor. Open the shutoff valve. If fuel does not flow out of the carburetor there is a restriction in the carburetor. See service manual or call your dealer.

Ignition Troubles - Check to see if:

-Hood itching the plug. Raise the hood and attempt to start the engine .
-Spark plug is fouled or wet. Remove the plug and clean, dry, or replace it. Correct gap to .025 inch (.635 mm).
-Engine is getting a spark from the magneto. Remove the magneto from the spark plug and crank the engine by hand, holding the cable end so that the spark can jump to the cylinder head. If there is no spark when the magneto is heard to click, or a weak spark (less than 3/16 inch or (4.76mm). Check the connections. If these are all right, the magneto is defective .
-Ignition stop button is shorted out. To test, remove the ground wire from the magneto stop button and attempt to start the engine. See service manual or call your dealer. (See 5, figure 7.)

Carburetor and Air Cleaner Trouble - A flooded carburetor or a clogged air cleaner may keep the engine from starting.

If gas is dripping from the carburetor, it is flooded. Wait 10 to 15 minutes before further attempting to start the engine.

Check air cleaner element; if dirty, clean or replace (See Air Intake System)

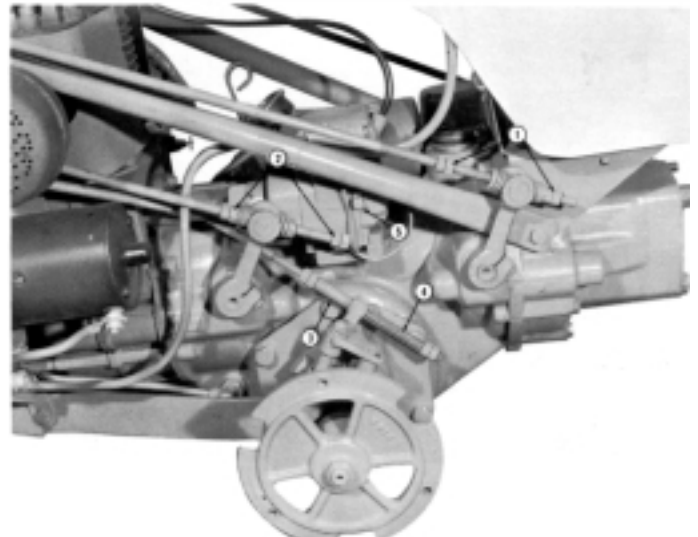

Figure 7

Adjustments

Following are common adjustments which most users can readily perform:

Spark Plug - The spark plug should have its gap set at . inch (.635 mm.).

Clutch Rods - To adjust clutches, tighten the locknuts, 1 and 2 in Figure 7, until the clutch rod springs are compressed fully as each lever goes over center in the fully engaged position, either high or low gear or forward or reverse.

Range Selection Linkage -The toggle spring (locate y the range ever occasionally may require adjustment by tightening the hex nuts on the toggle rod until the spring is compressed to 15/16 inch (23.81 mm). Figure 3 and 4. To adjust springs, (3 and 4 in Figure 7), have the range selection lever engaged fully in high or low range, move the hex nuts (1 and 2 in Figure 7) on the spring rod until each spring is compressed 2 1/2 inches (63.5 mm).

Carburetor - If absolutely necessary to adjust the carburetor, follow these instructions:

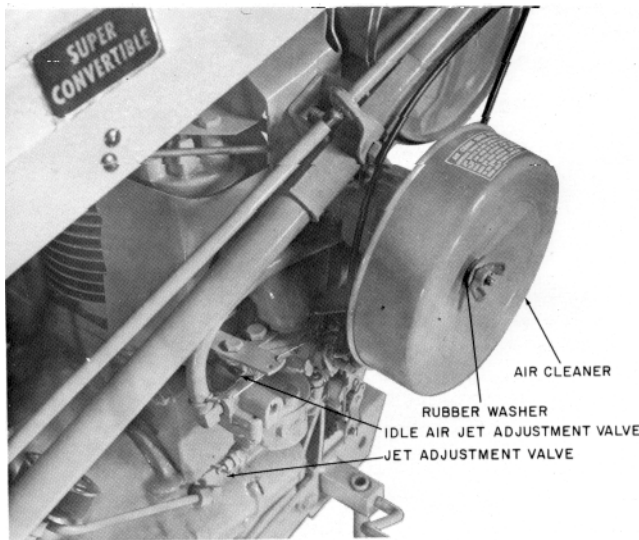

Figure 8

1. Screw the jet adjustment valve (a brass T-valve) in until it is snug. Do not force or screw it tightly.
2. Back off the jet adjustment valve 1 1/2 turns.
3. Start the engine and open the throttle halfway. After the engine warms up, begin screwing the jet adjustment valve in slowly. As soon as the engine slows down, stop and back the valve off until engine picks up speed.
4. Screw the idle air jet adjustment valve (a slotted head screw with a spring around it) all the way in; then back off 1 turn. Start the engine and allow it to idle. Screw the idle air jet adjustment valve in until the engine begins to run rough. Then back the valve off the engine runs smooth.

Valves - Adjust the valves only when the engine is cold. Remove the valve cover cap, adjust tappet to .015 (.397mm) inch.

Fan Belt - Fan belt tension is adjusted by moving the fan belt pulley (the pulley at the fan) upwards, to increase tension. To adjust; loosen the large thin nut between the fan belt pulley and fan housing. Tighten after proper tension is reached.

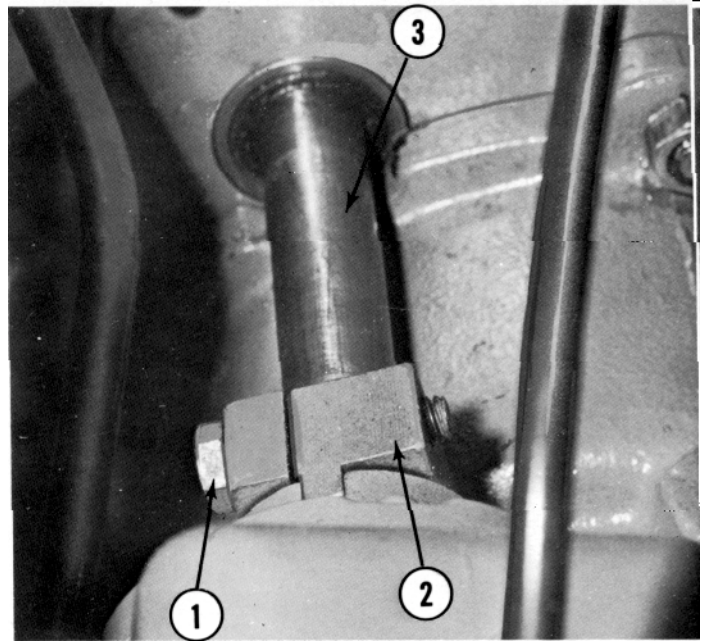

Figure 9

Timing - The magneto should be set to fire approximately 20 degrees before top dead center. To adjust:

1. Loosen magneto coupling nut (1, Figure 9) until the coupling slips on the camshaft. It may be necessary to tap the coupling gently.
2. Remove the cylinder head.
3. Bring the piston to top dead center on the compression stroke (both valves closed).
4. Turn the starter pulley counterclockwise until the piston goes down the cylinder approximately one inch. Then bring the piston back up the cylinder to 3/8 inch (9.525mm) from top of cylinder. This procedure takes up any backlash in the gears.
5. Align the timing marks (straight marks) on the magneto.
6. Be sure that there is at least .015 inch (.397mm.) end play in the magneto coupling so it will not cramp the impulse. Use feeler gauge between the fiber block (2, Figure 9) before tightening nut. Tighten nut.
7. Check your settings by backing the piston not more than two inches down the cylinder barrel (to avoid picking up the magneto impulse) and bring the piston up to 3/8 inch from top of cylinder, magneto marks should align.
8. When timing is correct, install cylinder head and magneto cover.

SPECIFICATIONS

| Model | Custom | Super |
|---------------|---------------------------------|---------------------------------|
| Engine | Gravely | Gravely |
| Type | 4-cycle air cooled | 4-cycle air cooled |
| Horsepower | 7.6 | 7.6 |
| Bore & Stroke | 3.25 x 3.50 (82.55mm x 88.80mm) | 3.25 x 3.50 (82.55mm x 88.80mm) |
| Displacement | 29.0 cu. inch(475.1cc) | 29.0 cu. in. (475.1 cc) |
| Speed | 2600-2800 RPM | 2600-2800 RPM |
| Valve Setting | .015 in. (.397 mm) | .015 in. (.397mm) |
| Fuel | Regular | Regular |
| Capacity | | |
| Fuel Tank | 1.75 U. S. Gal. (6.63L) | 1.75 U. S. Gal. (6.63L) |
| Chassis | 5 pts. (2.36L) | 5 pts. (2.36L) |

ATTACHMENT OPERATING INSTRUCTIONS

30" ROTARY MOWER

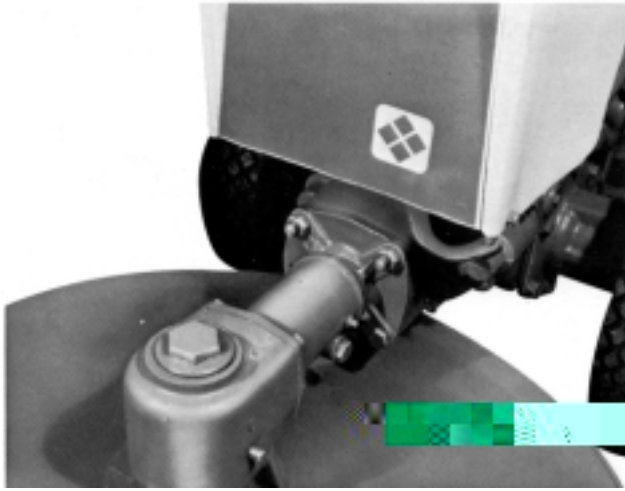

Figure 10

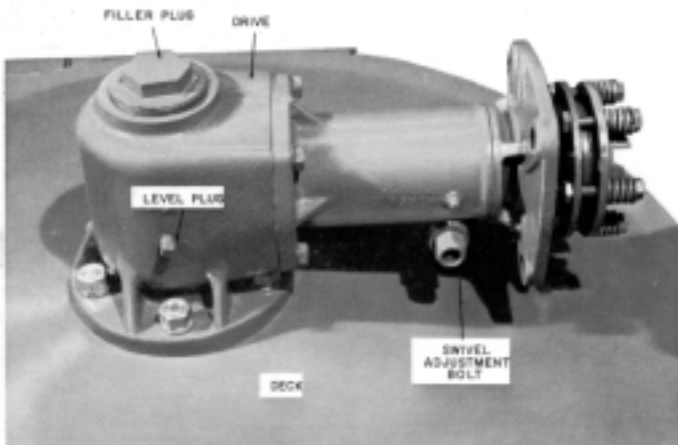

Figure 11

LUBRICATION

Use SAE 140 or 90W EP gear lubricant in the Gear Housing. Use General Purpose Grease occasionally in the Gear Fitting of the Swivel Casting.

Check the Gear Housing oil level every eight hours of operation by removing the Oil Level Plug (Figure 11). If oil runs out, the oil level is all right, if not, oil must be added.

To add oil, remove the Oil filler Plug, (Figure 11), and pour through the Oil Filler Hole until oil begins to run out the Oil Level Hole. Replace both plugs before operating.

ATTACHING

The 30" Rotary Mower cuts a maximum swath of 30 inches or 76.2 centimeters and is attached to the tractor using two Nuts and two Bolts. See Figure 10.

SAFETY PRECAUTIONS

1. Do not let anyone operate the machine until he has had proper instructions.
2. Be sure the work area is clear of objects which might be picked up and thrown.
3. Do not direct the discharge of material toward bystanders.
4. Keep all shields in place.
5. Disengage power to attachment and stop motor before making adjustments.
6. Do not wear loose fitting clothing that might get caught in moving parts and keep your hands and feet away from moving parts.
7. Never operate the Mower unless the Front Fender or optional Chain Guard is on the front of the Mower, and the Rear Fender is on the rear.
8. WHEN USING THE 30-INCH ROTARY MOWER, NEVER SHIFT THE INSIDE OPERATING LEVER DIRECTLY FROM HIGH TO LOW. ALWAYS PAUSE MOMENTARILY IN NEUTRAL, GIVING THE BLADE A CHANCE TO SLOW DOWN NATURALLY, THUS AVOIDING THE SEVERE BRAKING ACTION FROM A SUDDEN SHIFT INTO LOW GEAR.

ADJUSTMENTS

Swivel Action Adjustment

Swivel action of the Drive Assembly is regulated by the Swivel Adjustment Bolt and Nut, (Figure 11).

Loosening the Adjustment Nut frees swivel action; tightening it restrains swivel action.

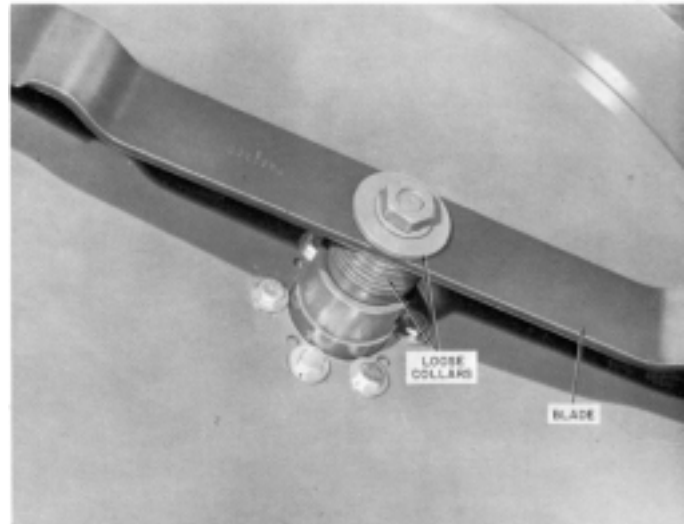

Figure 12

Cutting Height Adjustment

Cutting height is adjusted by the Collars on the Rotor Shaft. The closer the Blade is to the Gear Housing, the higher the cut, and vice versa.

Blade Sharpening

Use a grindstone to sharpen the Blade. Try to follow the same bevel as the originally-sharpened cutting edge, although the precise degree of bevel is not critical.

Fender Adjustment

When mowing short weeds and lawns, the Front Fender (the small fender) should be on the front of the Mower Hood, and the Rear Fender (The Larger Fender) on the rear.

However, when mowing high, heavy brush, or thick tough grass of considerable height, better mowing results will be obtained by removing the Front Fender, and replacing it with the optional chain Guard.

30" ROTARY MOWER ATTACHMENTS

Chain Guard

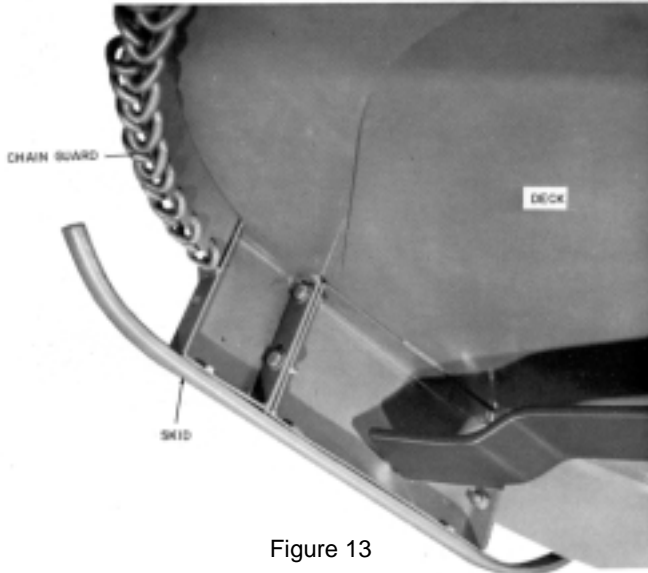

Figure 13

When the Front Fender is removed, it must always be replaced with the optional Chain Guard. It is attached to the Mower by Bolts in place of the Front Fender. The Chains reduce the velocity of materials that may be thrown out.

Leaf Mulcher



Figure 14

Attach the Leaf Mulcher to the 30-inch Rotary Mower as follows:

1. Remove both the Front and Rear Fenders. Bolt the Rear Fender to the front of the Mower Deck.

2. Attach the Leaf Mulcher to the rear of the Mower Hood, in the position normally occupied by the Rear Fender.

To operate the Leaf Mulcher, proceed the same as you would in mowing. Normal walking speed is usually adequate to do a good job, although when leaves are wet or packed down, you may have to go over the area twice.

Circular Saw



Figure 15

Attach the 18-inch (45.72cm) circular saw to the drive assembly as follows:

1. Remove the mower assembly from the drive assembly.
2. Place all collars but two on the rotor shaft. Place the circular saw on the shaft and then the remaining collars and then install the nut and tighten securely.

NOTE: Cutting edges of the saw teeth must face in the direction of the shaft rotation.

4. Install the saw guard of the gear housing.

Operating Hints

Feed the Circular Saw by exerting slight pressure on the Tractor Handles. Do not force the Saw .
...The Circular Saw is most effective for clearing land of saplings, sprouts, and other small growth. We do not recommend the Circular Saw for felling large trees .
...Be careful not to run the Saw into the ground or against rocks.

Storage

When the Circular Saw is to be stored for several days or longer, we recommend you coat it with general purpose grease.

40" MOWER

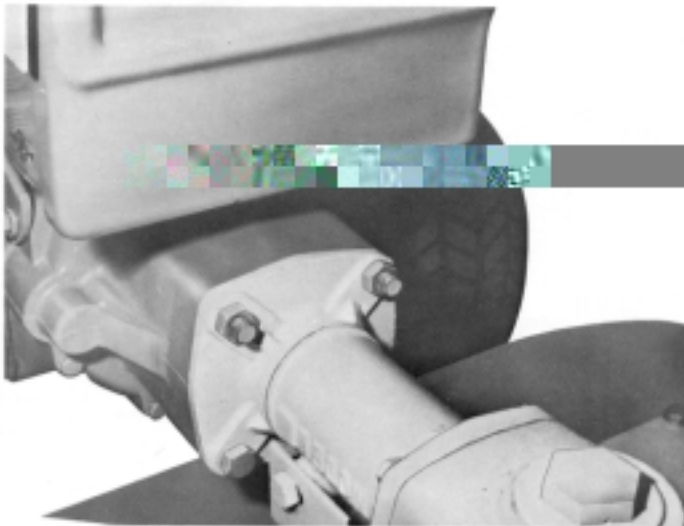

Figure 16

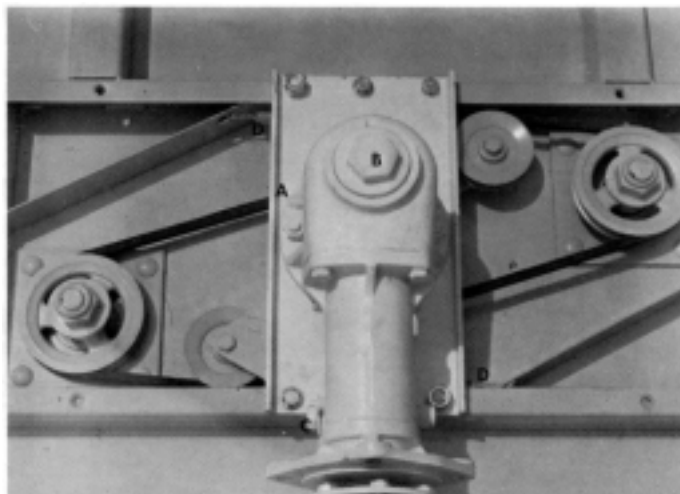

Figure 17

LUBRICATION

Check the Gear Housing oil level every eight hours of operation by removing the Oil Level Plug shown at A in Figure 17. If oil runs out, the oil level is all right, if not, oil must be added until the proper oil level is obtained. To add oil, remove the Oil Filter Plug shown at B in Figure 17, and pour through the hole until oil begins to run out the oil level hole. Replace both Plugs before operating the Mower. Use SAE 140 or 90W EP lubricant. Use a good grade of general purpose grease occasionally in the grease fitting of the Swivel Casting. Blade spindles should be lubricated every 8 hours of service with general purpose grease. Apply lubricant through the grease fitting until lubricant starts to come out the vent hole on the opposite side of the spindle. No lubrication is required for the two Belt - Tightening Idler Pulleys.

ATTACHING

The 40" Rotary mower cuts a maximum swath of 40 inches or 1.006 meters. It attaches to the tractor using 2 bolts and two nuts as shown in figure 16.

CAUTION

When attaching, be sure the Engine is stopped, and the Attachment Clutch Control is at the "OUT" position and the operating levers are in the neutral position.

SAFETY PRECAUTIONS

1. Do not let anyone operate the machine until he has had proper instructions.
2. Be sure the work area is clear of objects which might be picked up and thrown.
3. Do not direct the discharge of material toward bystanders.
4. Keep all shields in place.
5. Disengage power to attachment and stop engine before making adjustments.
6. Do not wear loose fitting clothing that might get caught in moving parts and keep your hands and feet away from moving parts.

ADJUSTMENTS

Swivel Action Adjustment

The Swivel actions the Mower is regulated by the Bolt and Nut on the Swivel Casting (C, Figure 17).

Belt Adjustment

None required. Belts are tensioned automatically by spring-loaded Idlers.

Belt Replacement

Remove both Belt Covers.

Detach one end of each Idler Tension Spring (D, Figure 17).

Remove Belts from around Rotor Pulley and Idler Pulleys. Remove the two Nuts and three Bolts holding the Drive Mounting Plate to the Deck. Remove the Drive and Belts.

Replace Belts by reversing the above procedure.

Put new Belts on Drive Pulley before re-attaching Drive Plate to Mower.

Cutting Height Adjustment

The cutting height of the Mower is adjusted by the Collars on the Rotor Shaft. The closer the Blades are to the under side of the Deck, the higher the cut, and vice versa.

Vary the combination of the Collars as you desire.

Caster Wheel Adjustment

Caster Wheels keep the Mower parallel to the ground. If the Mower cuts closer on one side than it does on the other, or if the Skids mark the ground, the Caster Wheels should be adjusted. Adjustment is accomplished by removing "Hairpin" Cotter Pins from the top of the fork, and rearranging the Spacing Washers as required.

To replace Wheels, remove Elastic Stop Nut and remove the Axle Bolt, replace with new Wheel by reversing the procedure.

Blade Sharpening

Use a grindstone to sharpen the blade. Try to follow the same bevel as the originally sharpened cutting edge, although the precise degree of the bevel is not critical.

Removing the Blades

Use a standard 3/8 inch socket drive in the square hole in the bottom of the rotor shaft to hold the shaft while removing the blade nut.

SICKLE MOWER

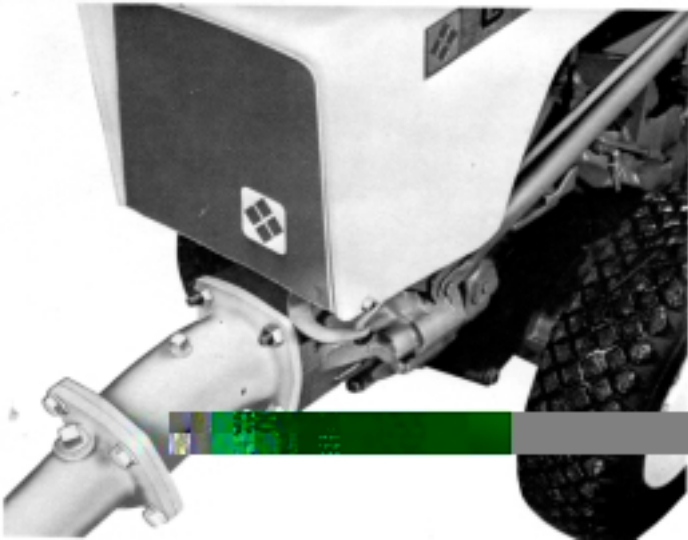

Figure 18

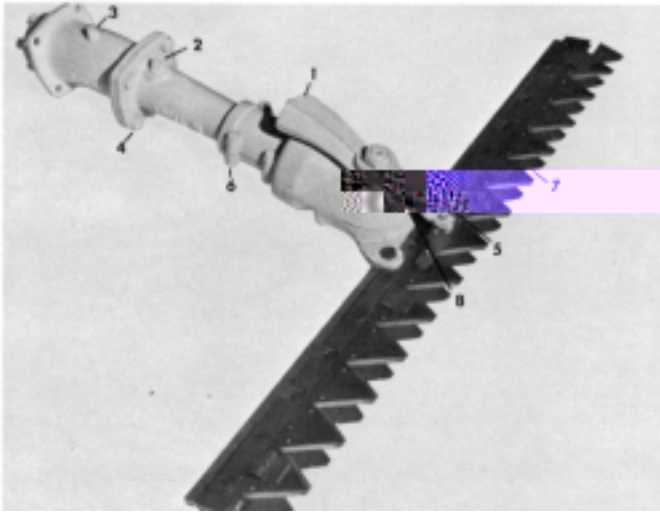

Figure 19

LUBRICATION

Check the Drive Assembly oil level every 8 hours of operation by removing the Oil Level Plug, (8 in Figure 19). If oil runs out, the oil level is all right; if not, oil must be added.

To add oil, remove the Oil Filter Plug, (2 in Figure 19), and pour through the Oil Filler Hole until oil begins to run out the Oil Level Hole. Replace both Plugs before mowing.

Use SAE 140 in the Drive Assembly.

To lubricate the Universal Joint, remove the Grease Plug, (3 in Figure 19), and fill about half-full with general purpose grease.

ATTACHING

The Sickle Mower attaches to the convertible 7.6 tractor using two Nuts and two Bolts. See Figure 18.

SAFETY PRECAUTIONS

Never attempt to clear the Mower, or make any adjustment whatsoever, unless the attachment is out of gear and stopped, and the Tractor Engine is stopped.

Never handle the attachment by any cutting surface. Keep hands away from Knife Sections. Grasp the Mower by its Drive Column and other non-cutting surfaces to carry it.

Try to keep clear of rocks and debris, as these will damage the cutting surfaces.

ADJUSTMENTS

To insure satisfactory performance, perform the following adjustments as required:

Bolts

Although the Sickle Mower is built and balanced carefully it is still subject to vibration. Periodically tighten all Nuts and Bolts, doing this at more frequent intervals when doing heavy cutting.

Clips

proper adjustment, the Clips should allow the Knife to slide back and forth easily (with the pressure of a finger and thumb). The Clips should hold the Knife in firm contact with the Shear Plates, (7 in Figure 19), but should not cause binding. To adjust, knock the Clips down gradually with taps from a light hammer.

Swivel Action

To increase swivel action allowing the Mower to follow the contour of the ground, loosen the Bolts, (6 in Figure 19).

When these Bolts are tightened firmly, the Mower is held in rigid position. The Bolts should be tight enough to the Guide Bar will hold its position until lowered, but loose enough for the Guide Bar to follow the contour of the ground.

Guards

Always keep the Guards, (7 in Figure 19), in alignment.

Tap with a light hammer until the knife sections lie flat on the Shear Plates of the Guards. Keep the Guard Bolts tightened securely.

CARE OF THE KNIFE

For best performance, keep the Knife Sections sharp. To remove the Knife for sharpening, remove the Knife Brackets Screws, (5 in Figure 19) and slip the Knife out either side. Grind the Knife sections along the same bevel as ground originally. When replacing the Knife, make sure the Knife Bracket Screws are tightened firmly.

NOTE: It is good practice always to have an extra Knife, already sharpened, which you can put on the Mower when needed.

No lubrication is required for the Knife while in operation.

However, to prevent rust, oil the Knife and Guide Bar with a thin coat of light oil after operating. Use a paint brush or similar type of applicator. When the Mower is to be stored for any period of time, clean it thoroughly and apply general purpose grease to all unpainted parts.

OPERATING HINTS

Always mow at a normal walking speed with the Tractor in low gear. Excessive speed will exaggerate the Mower vibration, causing the Nuts and Bolts to become loose.

If excessive vibration is encountered, check to see if the Wearing tip (on the end of the Actuating Lever) is worn or missing, or if the Bracket is worn badly.

If cut grass or weeds begin collecting on the Mower instead of feeding-off properly, check the alignment of the Guards and Knife Sections, as well as sharpness of the Knife Sections.

If this does not correct the improper feed-off, make sure one end of the Mower is not dragging up already cut material. This is the result of taking too small a "bite". Another cause of improper feed-off is a rusty or gummy Mower. Always keep it clean.

LAWN CARE

Lawn Roller



Figure 20

Roll out lawn problems with Gravelly's Lawn Roller attachment.

Water filled Lawn Roller follows ground contour to level your lawn, take out unsightly humps.

Compacting the soil gives you a more close knit, firmly rooted lawn, more resistant to weeds, disease, and drought.

Particularly use for rolling down frost and freeze damage.

Cart



Figure 21

All-Steel Cart has about a 112 ton capacity. Sturdy, reinforced with a latch-release.

Seeder-Spreader

Ride in comfort as you seed and fertilize your lawn. Easy controls for even, accurate coverage of seed, lime or fertilizer. . . spreader is five feet wide for fast coverage. Hopper has 300 lb. capacity.



Figure 22

MOUNTING

The seeder-spreader, Lawn Roller, and Cart each require the Roller Rest Kit for mounting to the tractor.

LUBRICATION

Steel Cart and Seeder Spreader - use General Purpose grease occasionally in the grease fitting on each wheel.

Lawn Roller - An occasional greasing of the Axles with General Purpose Grease is the only lubrication required. To lubricate, remove the Cotter Pin and slip off the large washer and pack grease around bearings. Make sure the washer and cotter pin are replaced.

SAFETY PRECAUTIONS

1. Do not let anyone operate this machine without proper instructions.
2. Do not drive too close to a creek or ditch.
3. Watch out for traffic when near roadway.
4. Stay alert for holes and other hidden hazards.
5. Watch where you are driving. Pay attention.
6. Beware of steep slopes.
7. Reduce speed on all side slopes and sharp turns to prevent tipping or losing control.
8. Do not attempt to operate the machine when not in the operator's position.
9. Don't carry passengers.

OPERATING HINTS

Filling the Roller: move the Roller until the Filler Plug (a large plug on the side of the Roller) is at its highest point. Remove the plug to fill the Roller; be sure it is replaced after filling. Water generally is used.

Dumping Cart. The cart is dumped by releasing the Lever which holds the Cart to the frame and tilting the Cart to the frame and tilting the Cart to the rear.

Distribution Controls: To determine the proper distribution of seed or fertilizer, refer to the self-explanatory

plate attached to the Hopper. Simply set the Port Lever to the indicate opening to distribute seed or fertilizer properly.

Care of Hopper Assembly: Many materials used in the Seeder-Spreader, especially certain fertilizers, are corrosive. Abrasives also are present. This means the protective paint soon will wear off the Port Assembly and Agitator. To protect these surfaces,

wash the Seeder-Spreader thoroughly with water after using and let it dry, preferably in the sun. If you do not intend to use it again within a few days, pour a small quantity of oil along the Port Openings and work the Port Lever back and forth to distribute the oil.

TWIN-TOOL GARDENING

ROTARY PLOW AND ROTARY CULTIVATOR

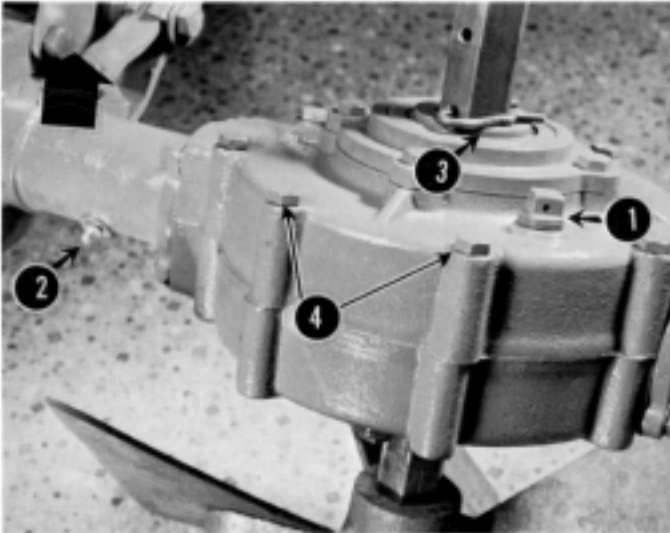

Figure 23

The Rotary Plow is attached to the Tractor by two Nuts and two Bolts. One Bolt and one Nut must be used to attach the Angle Adjusting Bracket, upper left in Figure 23.

LUBRICATION

Check the Gear Housing oil level every eight hours of operation. Gear Housing capacity is 1 1/2 pints. Use SAE 140 or 90W EP gear lubricant.

Add oil by removing the Oil Filter Plug (1 in Figure 20). Use occasionally General Purpose Grease in the swivel casting grease fitting, (2 in Figure 23).

SAFETY PRECAUTIONS

1. Do not let anyone operate the unit without proper instructions.
2. Keep all shields and safety devices in place.
3. Disengage power to any attachment and stop engine prior to making adjustments.
4. Pay attention to what you are doing.
5. Don't wear loose fitting clothing that might get caught in moving parts. Keep hands and feet away from moving parts.

ADJUSTMENTS

Depth of Cut Adjustment

Use the pin or clip, (3 in Figure 23), in the Hex Shaft for initial Cutting depth adjustment. The higher on the Shaft the Pin is inserted, the greater the depth of cut and vice versa. Ordinarily, the Pin is inserted in one of the top holes for plowing and in the bottom hole for transporting.

A final cutting depth adjustment, is required, is made by sliding the Wheel Bracket Clamp, (1 in Figure 24), up or down in the slitted Wheel Bracket. The lower the Clamp is set, the lower depth of cut.

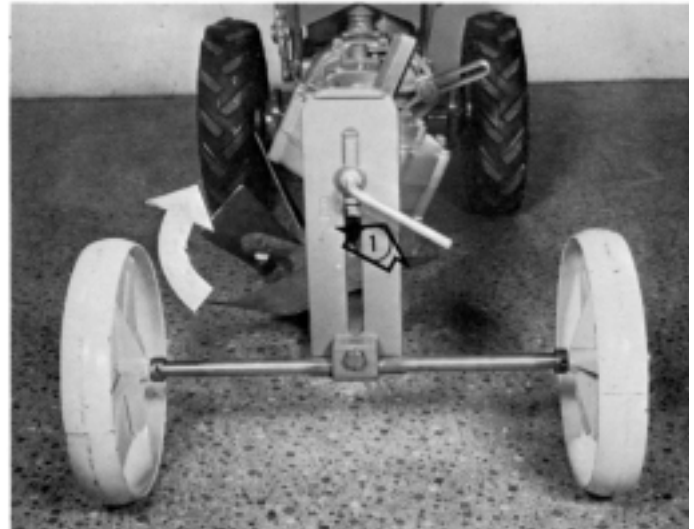

Figure 24

Plowing Angle Adjustment

When plowing for the first time, set the Plow at the approximate angle to the ground as shown in Figure 24. The Nut which secures the Angle must be loosened to do this; be sure it is tightened firmly after the proper angle is set.

The bolt through angle adjusting bracket should be about 3/4 inch (19.05cm) from the bottom of the slot.

If there is excessive drag to the left (left, as you stand at the handles) move the Plow in the direction of the arrow in Figure 24. If there is excessive drag to the right, move the Plow opposite the direction of the arrow.

A few trials may be required before the Plow is adjusted properly to soil conditions.

Width of Cut Adjustment

The width of cut is governed by the position of the Wheel Bracket in relation to the Depth Wheel in the furrow. The closer the Wheel Bracket is to the Depth Wheel in the furrow, the narrower the cut, and vice versa.

DIRT SHIELD

The Dirt Shield is attached to the top of the Gear Housing by removing the bolts, (4 in Figure 23). inserting them through the Shield, and replacing in the Gear Housing. You can use the Dirt Shield to direct the throw of the dirt, by bending it up or down.

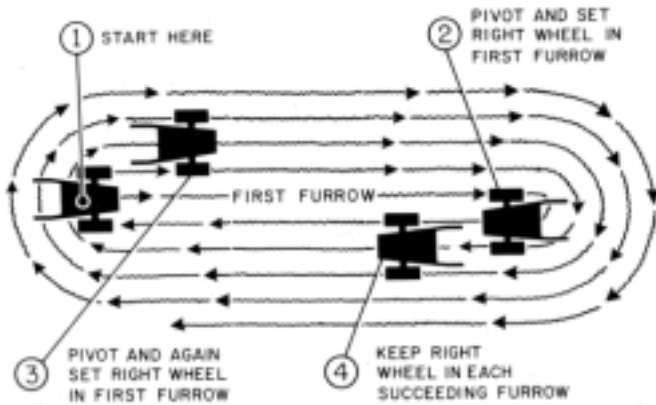

Figure 25

OPERATING INSTRUCTIONS

To plow, first run a furrow down the center of the land to be plowed. Then pivot the Tractor at the end of the furrow so the Right Depth Wheel is in the furrow just made. Continue this way so the dirt is always thrown toward the center (see Figure 25).

If you are plowing a large area, you will be able to "pull" the Tractor around corners without pivoting. However, in small areas it is necessary to pivot the Tractor each time.

When you are ready to pivot, bear down on the Handles until the Tractor is balanced. "Slip" the Clutch gently, holding back on the Right Handle, allowing the Engine to pivot the Tractor with little effort on your part.

Plowing is much easier if the Gear Housing is kept level with the ground when the Plow is in the furrow and plowing. To do this, try to obtain all depth adjustment by the holes in the Hex Shaft, and the horizontal adjustment by moving the Wheel Bracket laterally.

If you have the eight-speed Transmission, we recommend plowing with the Tractor in low range, which slows ground speed to a virtual crawl without affecting attachment RPM.

ROTARY CULTIVATOR

The Rotary Cultivator is attached to the Rotary Plow Drive Assembly as follows:

1. Leave the Plow Angle Adjusting Assembly (upper left in Figure 23) attached.
2. Remove the Hex Shaft (and Plow Blades) from the Gear Housing.

The Depth Wheels, Wheel Bracket and Column Assembly (which connects the Wheel Bracket to the Gear Housing) may be removed.

NOTE: After the Column Assembly has been removed, Bolts must be inserted into the Gear Housing to prevent oil leakage. We recommend short Bolts for this purpose; if the original Bolts are tightened, the Gears inside the Gear Housing will be fouled. If, however, you use the original Bolts, place sufficient Washers on them to prevent Gear fouling.

3. Remove the four Bolts from the bottom of the Gear Housing and insert the studs furnished.

NOTE: When assembling the rotary cultivator to the plow drive; be sure the oil plug on the drive housing is up when the cultivator is in the operating position.



Figure 26

4. Fit the Hood as shown in Figure 26. Insert the Cultivator Drive Shaft into the Gear Housing.
5. Rotate the Cultivator to the position shown in Figure 27. In this position the Tines will cut the same direction (clockwise) as the forward movement of the tractor.
6. Use the Lock Nuts to fasten the Cultivator Drive securely to the Gear Housing.
7. Install the Dust Shield and Fastener on the top of the Hex Shaft.
8. Use the Adjusting Bracket to lock the Cultivator in place with the long axis of the Cultivator parallel to the Tractor Axles.

NOTE: The Gravely Triple-Purpose Wrench, available from your Gravely dealer, fits the Cultivator Tine Shaft Nut.

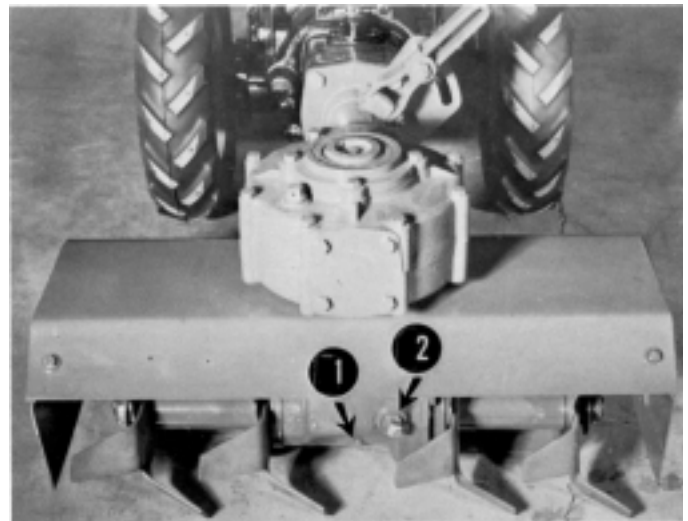

Figure 27

LUBRICATION

Check the Cultivator Drive Assembly oil level every eight hours of operation by removing the Oil Level Plug, (1 in Figure 27). If oil runs out of the Oil Level Hole, the oil level is all right; if not, oil must be added.

To add oil, remove the Oil Filler Plug, (2 in Figure 27), and pour through the Oil Filler Hole until oil begins to run out of the Oil Level Hole. Replace both Plugs when proper oil level is reached.

Use SAE 140 or 90W EP gear lubricant. Be sure the Cultivator is level when checking or adding oil.

OPERATING HINTS

The Rotary Cultivator is designed for cultivating soil which has been broken previously. It is not recommended for use as a Plow. Use the Gravelly Rotary Plow to prepare a seedbed in one operation and the Rotary Cultivator for cultivation throughout the season.

CULTIVATOR TOOLHOLDER

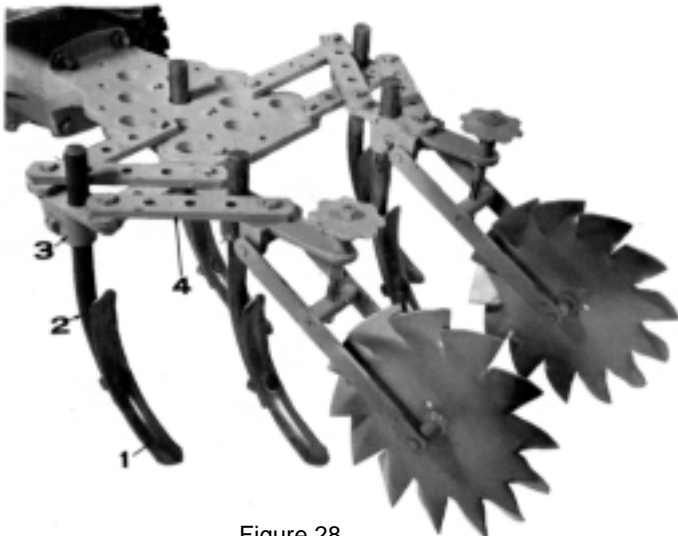

Figure 28

The Cultivator Toolholder, shown in Figure 28, can be used to hold a variety of cultivating tools. The most common set-up of cultivating tools in the Toolholder is shown.

In addition, the Cultivator Toolholder is used to hold the 36-inch Scraper Blade.

LUBRICATION

No lubrication is required, except oiling occasionally bolt threads for easier operation.

ATTACHING

Attaching to Tractor: the Toolholder is attached to the front of the tractor the same as power attachments. The Attachment Clutch Control should be at the OUT position.

Attaching Tools to Toolholder: the individual cultivating tool (1 in Figure 28), is attached to a Shank, (2 in Figure 28), which in turn is attached to the Toolholder by a Shank Holder (3 in Figure 28).

The Toolholder is equipped with five Shank Holders.

These may be moved to different positions on the Toolholder, if desired, although this is seldom necessary. Additional Shank Holders may be purchased from your Gravely dealer.

To attach a tool to its Shank, simply bolt it in place with the Bolts and Nuts provided.

To attach the Shank to the Shank Holder, loosen the Hexagon-Head Cap Screw in the side of the Shank Holder, slip the Shank into the Shank Holder from the bottom, and lock the Shank in place at the desired position by tightening the Cap Screw.

Changing Tools: after the Shanks have been attached to the Tool holder, changing cultivating tools requires only the unbolting of the old tool from its Shank and bolting the new tool on.

Parallel Bars: The Parallel Bars, (4 in Figure 28), can be adjusted in several ways, depending on the task.

STORAGE

When the Cultivator is detached from the Drive Assembly, place the small Spacers over the Studs and secure in place with locknuts.

Usually it is necessary to detach the bars from the Depth Wheels to make these different set-ups.

Usually the Depth Wheels provide all the adjustments required. However, if required, the Shanks can be moved up or down in the Shank Holders for additional adjustment.

Five Steel Set-Up is the standard arrangement; 1 1/4 inch (3.18cm) wide steels are used. (Figure 28).

Steels are available in 1 1/4 (3.18cm) 1 3/4 (4.45cm) and 2 1/4 (5.72cm) inch widths; standard length of the Steels is eight inches (20.32cm).

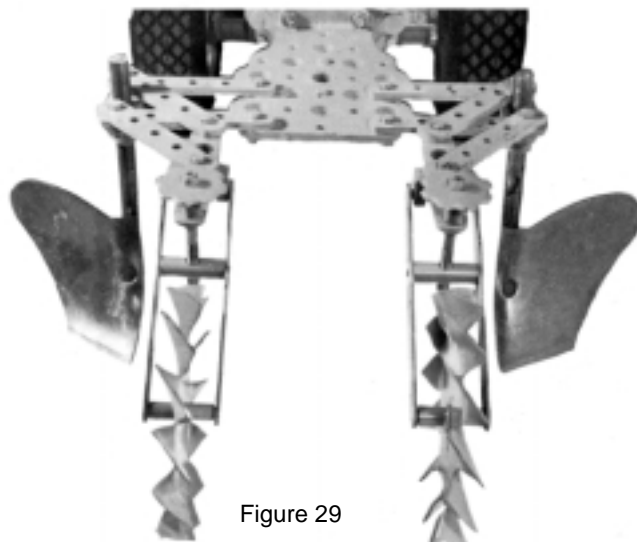

Figure 29

Six-inch (15.24cm) Hiller Set-Up uses right and left Hillers; these can be used for closing rows as well as for the killing. Hillers can be used to throw dirt away from or around the plants as desired. A furrower, available in 10 (25.40cm) or 12-inch (30.48cm) depths, can be used with the Hillers to bring from the center of the row to the Hillers, which in turn throw dirt around the plants. (Figure 29)



Figure 30

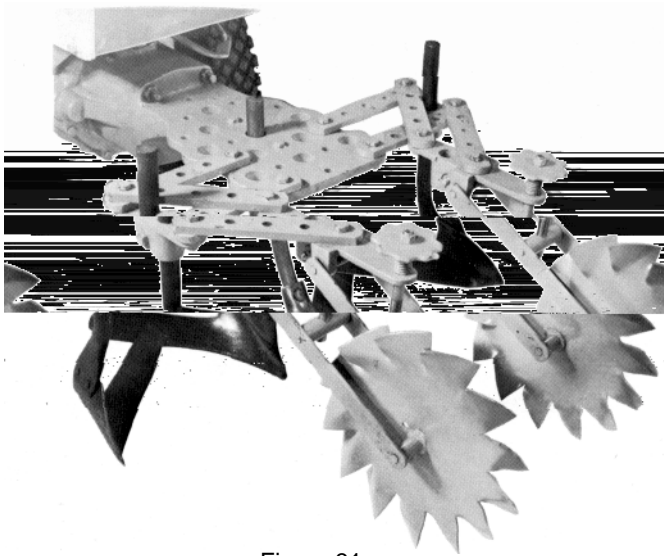

Figure 31

Furrowers can be used to lay off rows for planting. Also, many users find the Furrowers good tools for digging potatoes. For smaller furrowers, seven-inch (17.78cm) Shovel Steels are available; these can be used to lay off small seed crops and for center row cultivation.

Sweep and Hoe Set-Up uses an improved Sweep in the center and a right and left Hoe on the sides. The Sweep comes in 8 (20.32cm) 10 (25.40cm) 12 (30.48cm) and 16 (40.64cm) inch sizes. The Sweep clears the center of weeds and trash, while the Hoes eliminate the majority of handwork close to the plants. (Figure 31)

Adjustments: The Depth Wheels are used to set the depth the cultivating tools penetrate and ground. Facing the Depth Wheels, turn the Handwheels clockwise for deeper cultivation and counterclockwise for shallower cultivation.

OPERATING HINTS

Rows should be planted enough apart to accommodate the Tractor and Tool Holder. Normal distance between rows is 32 (812.8cm) to 36 (914.4cm) inches. Rows should be planted farther apart for plants which spread widely, unless you intend to shield the Tool Holder so plants will not be damaged.

SNOWBLOWER

LUBRICATION

All major bearings of the Snowblower that require lubricant are permanently lubricated, or are lubricated from the Tractor Transmission. However, the operator should check the oil level in the Gear Box by removing the upper plug. Oil should never be low, add SAE 140 lubricant.

ATTACHING

The Snowblower Drive Housing mounts to the front of the Tractor, using two bolts and two nuts. When attaching to the Tractor, the Chute Control Crank should be attached to the top Sprocket Housing Shaft of the Snowblower with the Rubber Connector and two (2) Clamps which are provided. See Figure 32.

The Crank should then be mounted to the Tractor left Driving Handle with the Crank Support and Crank Support Clamp.

Safe Snow Removal is No Accident

Improper use of snow removal equipment on the part of the operator can result in injury. To reduce this possibility, give complete and undivided attention to the job at hand. Protect yourself and others by following these safety tips:

1. Stop Engine before removing obstacles, making adjustments (except with the Control Crank), or when leaving the operating position.
2. Disengage the Power Take off and wait until the Fan stops before adjusting the deflector. Never direct discharge at bystanders, or allow anyone in front of machine - debris may be hidden in the snow.

3. Keep children and pets a safe distance away.
4. Do not allow children to operate machine, nor allow adults to operate it without proper instructions.
5. Adjust height of skids clear gravel or crushed rock surface.
6. Exercise caution to avoid slipping or falling, especially when operating in reverse.
7. Know the controls and how to stop quickly.

ADJUSTMENT

Discharge Chutes: to position the Discharge Chute, turn the Control Crank. The Discharge Chute will rotate approximately 165 degrees from extreme left, through the vertical position, to the extreme right.

As the Crank is turned, the Deflector opening is also rotated from the extreme left position through a forward position approximately 180 degrees to the extreme right position.

Deflector: to provide accurate placement of the blown snow near the Blower on either side or forward throw, loosen the Large Wing Nut on the Deflector and adjust the Deflector position.

CAUTION: Be sure Engine is stopped and Attachment out of gear and stopped.

Skids: To raise or lower the Snowblower cutting edge, first disengage the power take off and stop the Tractor Engine. Then loosen the Skid Mounting Bolts and slide the Skids up or down as desired, and retighten the Skid Mounting Bolts securely. This adjustment can be made more accurately if the cutting edge is placed on blocks while the adjustment is made.

Reel Clutch: the Reel Clutch is properly adjusted at the factory. If it should become necessary to tighten the Friction Clutch in the Reels, turn off the Tractor Engine, disengage the Power Take Off, and after all movement has stopped, block the rotation of the Fan. Now tighten the large Nut on the right end of the Reel Shaft (as viewed from the front of the Snowblower). See Figure 33.

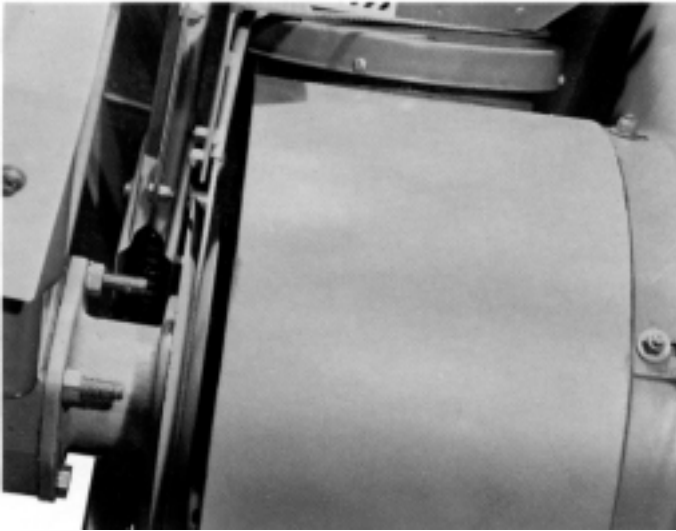

Figure 32

The Nut should be tightened to 85 to 95 lb. feet of torque.

Over tightening can cause damage to the Snowblower.

Control Shaft Clutch. The Fan Housing is prevented from rotating by a small Friction Clutch on the Top Sprocket Housing Shaft, except when the Control Crank is turned by the Operator. The resistance of the Clutch may be varied by adjusting the Nut on the top Sprocket Housing Shaft. Adjust the Nut so that it is just tight enough to prevent the Fan Housing from rotating during operation of the Snowblower except when the Fan Housing is rotated by the Control Crank

ACCESSORIES

A special Accessory Kit is available which includes:

Drift Cutters. Two Cutters are provided. These mount inside the Reel Housing ends and extend upward to slice through snow up to 30-inches (76.2cm) deep. The Drift Cutters are flared to assist turning in deep snow. No adjustment is necessary.

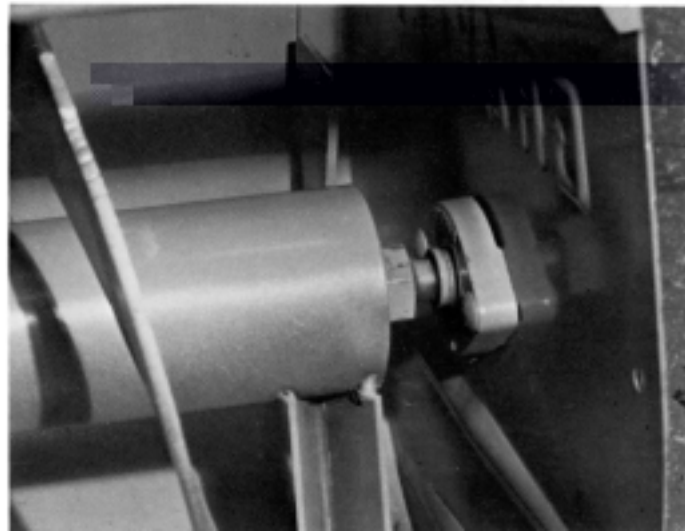

Figure 33

Castors. Two caster Weldments and Mounting Brackets are included. These bolt to the inner sides of the Frame and may be used in place of the Skids. The Caster Bracket Holes are slotted, and three (3) pairs of holes are provided in the frame for height adjustment.

OPERATING HINTS

Keep the Engine at full throttle when using the Snowblower. With the Swiftmatic transmission, use low axle range.

If the Tractor stops suddenly while operating the snowblower, check the vent in the Fuel Tank Cap for clogging.

48" SNOWDOZER



Figure 34

ATTACHING

The snowDozer mounts to the Tractor using the two Bolts and two Nuts

SAFETY PRECAUTIONS:

1. Do not let anyone who is not familiar with the unit operate it before receiving proper instructions.
2. Do not operate too close to ditch or creek.
3. Watch for traffic when near a roadway.
4. Stay alert for holes and other hidden hazards.
5. Watch where you are driving. Pay attention.

ADJUSTMENTS

To set the SnowDozer to roll snow straight ahead, line up the center hole in the Bracket with the center hole in the Casting and insert the T-shaped Adjustment Pin.

To roll snow to the left, line up the right (right as you stand at the Handles) hole in the Bracket with the center hole in the Casting and insert the Pin.

To roll snow to the right, line up the left (left, as you stand at the Handles) hole in the Bracket with the center hole in the Casting and insert the Pin.

Wearing strip The Wearing Strip on the bottom of the Blade eventually may have to be replaced. To replace, simply remove the bolts, take off the old Strip, put the new Strip on, and tighten the bolts firmly

SKIDS

Optional. Skids are useful when working on gravel drives to keep the Blade high enough to remove the snow without removing the gravel

STEERING SULKY



Figure 35



Figure 36

MOUNTING:

The sulky chassis weldment attaches to each side of the rear hitch of the tractor. It is secured in place by installing the hitch bolt through the sulky chassis weldment and the hitch of the tractor. Place a flatwasher on the hitch bolt, and secure in place using a lockwasher and nut. Repeat for the other side.

OPERATION:

USE OF DUAL WHEELS ON THE TRACTOR IS REQUIRED.

The Steering sulky allows the tractor-sulky combination to be operated as a single unit.

The Tractor will turn in the direction the steering wheel is turned. Care should be used when operating the unit on slopes.

SAFETY FIRST:

1. Operate unit slowly and in an open area until you are familiar with the operation and action of this type of steering.
2. Always reduce speed on sharp turns.
3. Always keep a firm grip on the steering wheel.

LUBRICATION:

Upon Assembly and after every 8 use hours grease all fittings with general purpose grease. There are 6 fittings.

- Wheels - 2
- Spindles - 2
- Cross Bar - 1
- Steering Column - 1

RIDING SULKY



Figure 37

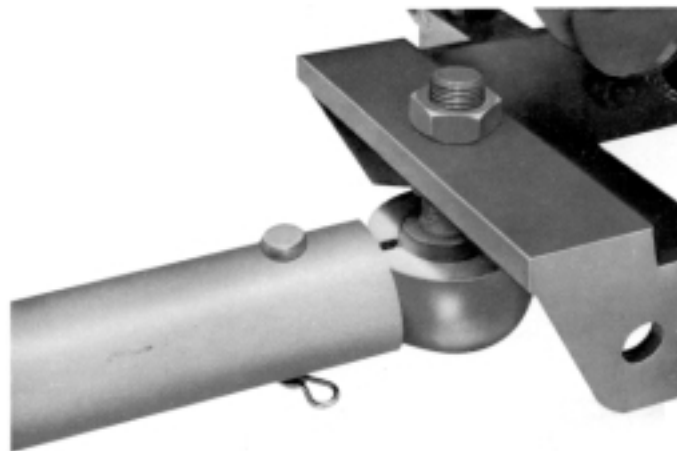

Figure 38

MOUNTING:

The Riding Sulky attaches to the tractor using the Trailing Hitch Kit.

LUBRICATION:

Upon Assembly and every 8 hours, grease the wheels with general purpose grease.

OPERATION:

The Riding Sulky allows the tractor operator to ride rather than walk.

SAFETY FIRST:

1. For slopes, terraces, and uneven terrain, disconnect the sulky.
2. Use extreme care when turning or backing up.
3. Always reduce speed in sharp turns.
4. Always keep a firm grip on handle bars.

Products manufactured by Gravely are warranted to be free from defective material and workmanship for a period of one year from date of purchase, under normal use by a homeowner, and for a period of ninety (90) days from date of purchase, when used for commercial purposes.

Any defective part manufactured by Gravely will be replaced without charge provided such part is certified as defective by the manufacturer or by the manufacturer's expressly authorized representative.

**IMPORTANT
PROVISIONS**

The foregoing warranty is in lieu of all others and GRAVELY MAKES NO REPRESENTATION OR WARRANTY OF ANY KIND, EXPRESS OR IMPLIED, AS TO MERCHANTABILITY, FITNESS FOR PARTICULAR PURPOSE, OR ANY OTHER MATTER.

This warranty is not subject to change or modification by field representatives or Gravely dealers.

Certain components carry separate warranties by the manufacturer of such components. Defective components are subject to their manufacturer's warranties, and any claims, work, or return of parts must be through an authorized Gravely dealer. Service costs for the transporting of a unit to and from the dealer are the responsibilities of the customer, and when such service is performed by the dealer, the dealer will charge the customer the usual rate for such service.

It is the customer's responsibility to mail the "Warranty Card" to the manufacturer within fourteen (14) days after date of purchase to ensure prompt handling of any warranty claim by the dealer or the manufacturer.



A Division of Clarke-Gravely Corporation
ONE GRAVELY LANE
Clemmons, North Carolina 27012

Free Manuals Download Website

<http://myh66.com>

<http://usermanuals.us>

<http://www.somanuals.com>

<http://www.4manuals.cc>

<http://www.manual-lib.com>

<http://www.404manual.com>

<http://www.luxmanual.com>

<http://aubethermostatmanual.com>

Golf course search by state

<http://golfingnear.com>

Email search by domain

<http://emailbydomain.com>

Auto manuals search

<http://auto.somanuals.com>

TV manuals search

<http://tv.somanuals.com>