

Hamilton Beach®

Toaster Oven

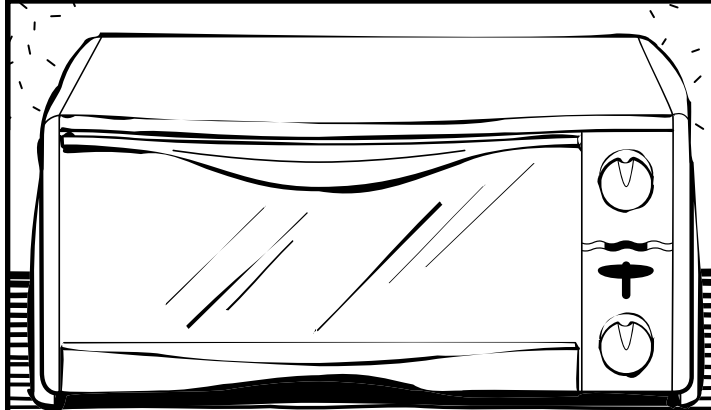

Safety	2
Parts and Features	5
To Toast	6
To Bake.....	8
To Broil	8
Cleaning	9
Troubleshooting	10

Customer Service in USA
1-800-851-8900

840073000

IMPORTANT SAFEGUARDS

When using electrical appliances, basic safety precautions should always be followed, including the following:

1. Read all instructions.
2. Do not touch hot surfaces. Use handles or knobs.
3. To protect against electrical shock do not immerse cord, plug, or toaster oven in water or other liquid.
4. Close supervision is necessary when any appliance is used by or near children.
5. Unplug from outlet when not in use and before cleaning. Allow to cool before cleaning appliance and putting on or taking off parts.
6. Do not operate any appliance with a damaged cord or plug, or after the appliance malfunctions or is dropped or damaged in any manner. Call our toll-free customer service number for information on examination, repair or electrical or mechanical adjustment.
7. The use of accessory attachments not recommended by Hamilton Beach/Proctor-Silex, Inc. may cause injuries.
8. Do not use outdoors.
9. Do not let cord hang over edge of table or counter, or touch hot surfaces.
10. Do not place on or near a hot gas or electric burner, or in a heated oven.
11. Extreme caution must be used when moving an appliance containing hot oil or other hot liquids. Be sure to allow hot oil or liquids to cool before moving appliance.
12. To disconnect, turn all controls to Off, then remove plug from wall outlet.
13. Use extreme caution when removing tray or disposing of hot grease.
14. Do not clean with metal scouring pads. Pieces can break off the pad and touch electrical parts, creating a risk of electrical shock.

15. Oversize foods or metal utensils must not be inserted in a toaster oven as they may create a fire or risk of electric shock.
16. A fire may occur if the toaster oven is covered, touching or near flammable material, including curtains, draperies, walls, and the like, when in operation. Do not store any item on top of the appliance when in operation, or before the appliance cools down.
17. Extreme caution should be exercised when using containers constructed of other than metal or glass.
18. Do not store any materials, other than Hamilton Beach/Proctor-Silex, Inc. recommended accessories, in this oven.
19. Do not place any of the following materials in the oven: paper, cardboard, plastic, and the like.
20. Do not cover crumb tray or any part of the oven with metal foil. This will cause overheating of the oven.
21. To turn oven off, turn ON/OFF Control Dial to OFF position. See "Parts and Features" section.
22. Do not place eyes or face in close proximity with tempered safety glass door, in the event that the safety glass breaks.
23. Always use appliance with crumb tray securely in place.
24. Do not use appliance for other than intended use.

SAVE THESE INSTRUCTIONS!

CONSUMER SAFETY INFORMATION

This appliance is intended for household use only.

This appliance is equipped with a polarized plug. This type of plug has one blade wider than the other. The plug will fit into an electrical outlet only one way. This is a safety feature intended to help reduce the risk of electrical shock. If you are unable to insert the plug into the outlet, try reversing the plug. If the plug should still fail to fit, contact a qualified electrician to replace the obsolete outlet. Do not attempt to defeat the safety purpose of the polarized plug by modifying the plug in any way.

The length of the cord used on this appliance was selected to reduce the hazards of becoming tangled in, or tripping over a longer cord. If a longer cord is necessary an approved extension cord may be used. The electrical rating of the extension cord must be equal to or greater than the rating of the toaster oven. Care must be taken to arrange the extension cord so that it will not drape over the countertop or tabletop where it can be pulled on by children or accidentally tripped over.

This appliance is equipped with a fully tempered safety glass door. The tempered glass is four times stronger than ordinary glass and more resistant to breakage. Tempered glass can break, however it breaks into pieces with no sharp edges. Care must be taken to avoid scratching door surface or nicking edges. If the door has a scratch or nick, call our toll-free customer service number.

Always unplug your toaster oven from the outlet when not in use.

Before First Use

Most heating appliances produce an odor and/or smoke when used for the first time. Plug the toaster oven into an outlet. Turn the ON/OFF Control Dial to 450°F. Heat at this temperature for 10 minutes. The odor should not be present after this initial preheating. Wash baking pan and oven rack before using.

4

Parts and Features

1. **ON/OFF Control Dial** – Also **Temperature Dial** to select baking temperature or broil mode. To turn the oven off, turn **ON/OFF Control Dial** to the OFF position.

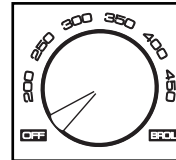

2. **Indicator Light** – This is lit when oven is on or when toasting.
3. **Toast Lever** – Push down to toast. The lever pops up when finished. To cancel cycle, lift lever.
4. **Toast Color Dial** – To select toast color.

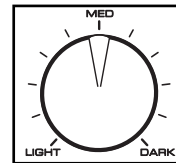

5. **Slide-Out Crumb Tray**

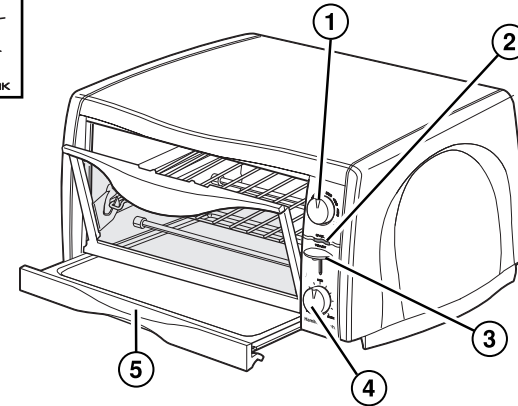

5

Oven Rack Positions

The toaster oven comes with a dual-position oven rack. Flip the rack over to change the position.



High Position



Low Position

Baking and Toasting

During the bake and toast functions, do not put a baking pan (or any other accessory or container) directly on the lower heating element.

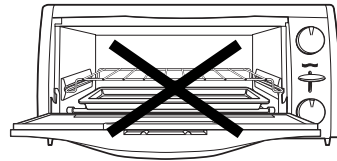

To Toast

Do not leave appliance unattended when in operation.

IMPORTANT! The ON/OFF Control Dial must be in the OFF position or unit will not toast.

1. Set ON/OFF Control Dial to OFF.
2. Place oven rack in the high position. If toasting less than four slices, place bread in center of oven rack.
3. Select toast color.

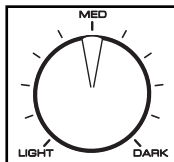
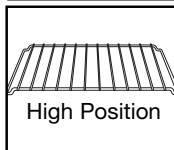
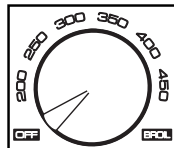

6

4. Push down Toast Lever. The Indicator Light will come on.
5. The Toast Lever will pop up when the toasting cycle is completed. On selected models, three beeps will sound at the end of the toast cycle.
6. Unplug from outlet.

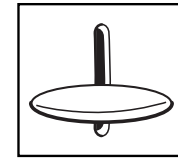

Do not leave the toaster oven unattended during toasting or top-browning.

Toasting Tips

- **To toast bagels**, place oven rack in the low position and place bagels cut side facing down. This will toast the cut side more than the outside of the bagel.
- **To toast English muffins**, place oven rack in the low position and place English muffins with the split side facing down. Set Toast Color Dial to the dark setting.
- **To toast frozen pastry or waffles**, place oven rack in the high position. Select a light color and toast directly on the oven rack. If pastry has a glaze or frosting, use baking pan.
- **To toast regular toaster pastries**, place oven rack in the high position. Set Toast Color Dial to Light and toast directly on the oven rack. If the pastry has a glaze or frosting, place the pastries on the baking pan.
- When toasting, **condensation** may form on the oven door. A toaster oven is enclosed so the moisture is slow to escape.
- When the Toast Lever pops up at the end of the cycle, **remove toast immediately** or the heat remaining in the toaster oven will continue to toast and dry out your toast.
- The **number of slices** of bread and the **bread freshness** will affect toast color. Adjust the Toast Color Dial to achieve the desired color.

7

To Bake

Do not leave appliance unattended when in operation.

Wash the baking pan and rack before using.

1. Place oven rack in low position depending on food to be cooked.
 2. Select temperature. The Indicator Light will come on.
 3. Let preheat for five minutes before beginning to bake.
 4. When finished, turn OFF. Unplug from outlet.
- To reduce the risk of fire, do not use oven cooking bags in the toaster oven.

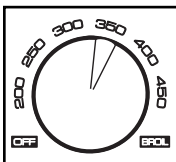

To Broil (Optional Feature on Selected Models)

Do not leave appliance unattended when in operation.

Wash the baking pan and rack before using.

1. Remove oven rack then place baking pan on top of heating elements.
 2. Place oven rack in high position. Place food on the oven rack.
 3. Set the Broiler Control Dial to Broil.
 4. The Indicator Light will come on.
 5. Halfway through cooking time, or when food has browned, turn food over to brown and cook other side.
 6. When finished, turn OFF. Unplug from outlet.
- Always allow at least one inch between the food and the heating element.

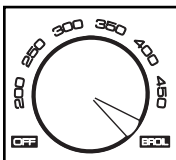
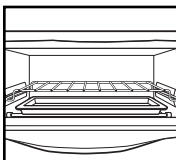

Cleaning

Your toaster oven should be cleaned regularly for best performance and long life. Regular cleaning will also reduce the risk of fire hazard.

Crumb Tray

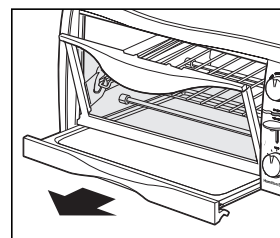

1. Unplug oven and allow to cool.
2. Wash oven rack and baking pan in hot, soapy water. Rinse and dry. These can be washed in the dishwasher, but may discolor.
3. To clean the crumb tray, slide open crumb tray.
4. Wipe crumb tray with a damp cloth. Slide back into position.

Bottom Door

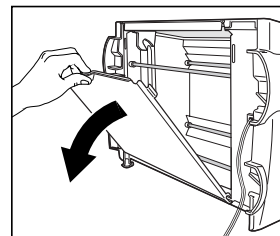

1. To clean bottom of oven, set oven on counter with glass door facing up. Pull open as illustrated.
2. To clean the inside of the oven, wipe oven walls and glass door with a damp, soapy cloth. Repeat with a damp, clean cloth.
3. For stubborn stains, use a plastic scouring pad.
4. To clean the outside of the oven, wipe with a damp cloth.
5. Do not use abrasive cleansers.

Do not clean with metal scouring pads. Pieces can break off pad and touch electrical parts, causing a risk of electric shock.

Troubleshooting

The toaster oven will not heat.

Check to make sure the electrical outlet is working and the oven is plugged in. Next turn the ON/OFF Control Dial to 350°F. The Indicator Light should now be lit.

The toaster oven will not toast.

Check to make sure the outlet is working and the oven is plugged in.

1. Set ON/OFF Control Dial to OFF.
2. Select toast color.
3. Push down the Toast Lever.

The Indicator Light should now be lit. The oven will not toast unless ON/OFF Control Dial is set on OFF.

Moisture forms on the inside of the oven door when toasting.

This is normal when toasting in a toaster oven. Moisture is slower to escape from the toaster oven than from a toaster. The amount of moisture will differ between fresh bread, bagels, and frozen pastry.

An odor and smoke comes from the toaster oven.

Smoke and odor is normal during the first use of most heating appliances. This will not be present after the initial heating period.

The Indicator Light stays on.

Turn ON/OFF Control Dial to OFF and make sure Toast Lever is in up position. If light stays on, unplug unit and call our toll-free customer service number for information on examination, repair or electrical or mechanical adjustment. Do not continue to use your toaster oven.

Some foods burn and some are not done.

Use the oven rack position to center food in the oven. Adjust the oven temperature or cooking time for best results with your recipes.

The oven beeps.

After two hours the oven will automatically shut off, but the Indicator Light will stay on. A beep will sound every two minutes until the ON/OFF Control Dial is turned to OFF or the oven is unplugged. To reset and continue cooking, turn ON/OFF Control Dial to OFF then reset at desired temperature.

Customer Service

If you have a question about your toaster oven, call our toll-free customer service number. Before calling, please note the model, type, and series numbers and fill in that information below. These numbers can be found on the bottom of your toaster oven. This information will help us answer your question much more quickly.

MODEL: _____ **TYPE:** _____ **SERIES:** _____

LIMITED WARRANTY

This product is warranted to be free from defects in material and workmanship for a period of two (2) years for Hamilton Beach Portfolio products or one (1) year for Hamilton Beach products from the date of original purchase, except as noted below. During this period, we will repair or replace this product, at our option, at no cost. THE FOREGOING WARRANTY IS IN LIEU OF ANY OTHER WARRANTY, WHETHER EXPRESS OR IMPLIED, WRITTEN OR ORAL INCLUDING ANY WARRANTY OF MERCHANTABILITY OR FITNESS FOR A PARTICULAR PURPOSE. ANY LIABILITY IS EXPRESSLY LIMITED TO AN AMOUNT EQUAL TO THE PURCHASE PRICE PAID, AND ALL CLAIMS FOR SPECIAL, INCIDENTAL AND CONSEQUENTIAL DAMAGES ARE HEREBY EXCLUDED. There is no warranty with respect to the following, which may be supplied with this product: glass parts, glass containers, cutter/strainer, blades, and/or agitators. This warranty extends only to the original consumer purchaser and does not cover a defect resulting from abuse, misuse, neglect, use for commercial purposes, or any use not in conformity with the printed directions. This warranty gives you specific legal rights, and you may also have other legal rights which vary from state to state, or province to province. Some states or provinces do not allow limitations on implied warranties or special, incidental or consequential damages, so the foregoing limitations may not apply to you.

If you have a claim under this warranty, DO NOT RETURN THE APPLIANCE TO THE STORE! Please call our CUSTOMER SERVICE NUMBER. (For faster service please have model, series, and type numbers ready for operator to assist you.)

CUSTOMER SERVICE NUMBERS

In the U.S. 1-800-851-8900

In Canada 1-800-267-2826

Web site address: www.hamiltonbeach.com

KEEP THESE NUMBERS FOR FUTURE REFERENCE.

HAMILTON BEACH ♦ PROCTOR-SILEX, INC.

263 Yadkin Road

Southern Pines, NC 28387

Web site address: www.hamiltonbeach.com

840073000

6/01

Free Manuals Download Website

<http://myh66.com>

<http://usermanuals.us>

<http://www.somanuals.com>

<http://www.4manuals.cc>

<http://www.manual-lib.com>

<http://www.404manual.com>

<http://www.luxmanual.com>

<http://aubethermostatmanual.com>

Golf course search by state

<http://golfingnear.com>

Email search by domain

<http://emailbydomain.com>

Auto manuals search

<http://auto.somanuals.com>

TV manuals search

<http://tv.somanuals.com>