

# Hamilton Beach®

## Water Softener

Models:

SA-HB-40-DB-CERT

SA-HB-48-DB-CERT



**MODEL: SA-HB-40-DB-CERT Water Softener**

Operating Temperature: 34°–120° F  
Operating Pressure: 20–60 psi (#5 injector); 61-120 psi (#4 injector)  
Voltage: 110V 60 cycles  
Rated Service Flow: 15.2 GPM @ 15 psi  
Rated Softening Capacity: 14.2 @ 3.0 (#5 injector)  
(Kilograins / Pounds of Salt) 24 @ 7.5, 37.0 @ 15 (#4 injector)  
Max Flow Rate to Drain: 4.0 GPM  
Amount of High Capacity Resin: 1.25 ft<sup>3</sup>  
Rated Efficiency: 4,720 grains @ 3.0 lbs

**\*\*Observe all state and local plumbing codes.**  
**\*\*This softener conforms to NSF/ANSI 44 for the specifically claimed performance.**  
**\*\*The efficiency of the softener is valid only at the stated salt dosage.**

Manufactured By:  
R&M Manufacturing  
28 South 1550 West  
Lindon UT 84042-1617  
(801) 785-5557

CAUTION: Do NOT use with water that is microbiologically unsafe or of unknown quality without adequate disinfection before or after the system.

pn: LBL-HB-40-CERT

**MODEL: SA-HB-48-CERT Water Softener**

Operating Temperature: 34°–120° F  
Operating Pressure: 20–60 psi (#5 injector); 61-120 psi (#4 injector)  
Voltage: 110V 60 cycles  
Rated Service Flow: 18 GPM @ 35 psi inlet  
Rated Softening Capacity: 15.1 @ 3.6 (#5 injector)  
(Kilograins / Pounds of Salt) 26.0 @ 9.0, 39.7 @ 18 (#4 injector)  
Max Flow Rate to Drain: 3.5 GPM  
Amount of High Capacity Resin: 1.5 ft<sup>3</sup>  
Rated Efficiency: 4,210 grains @ 3.6 lbs

**\*\*Observe all state and local plumbing codes.**  
**\*\*This softener conforms to NSF/ANSI 44 for the specifically claimed performance.**  
**\*\*The efficiency of the softener is valid only at the stated salt dosage.**

Manufactured By:  
R&M Manufacturing  
28 South 1550 West  
Lindon UT 84042-1617  
(801) 785-5557

CAUTION: Do NOT use with water that is microbiologically unsafe or of unknown quality without adequate disinfection before or after the system.

pn: LBL-HB-48-CERT

See pages 8 through 11 for:

- pre-installation checklist
- installation instructions
- start-up directions

## ***Table of Contents***

Introduction .....	4
Equipment Specifications .....	4
Job Specifications Sheet .....	5
Sizing Information .....	5
Water Conditioning .....	6
Homeowner Maintenance .....	6
Manual Bypass Valve .....	8
Pre-Installation Checklist .....	8
Detailed Installation Instructions .....	9
Start-Up Rinsing Procedure .....	10
Battery Backup Feature .....	12
Programming the Control Valve .....	12
Level I Programming .....	13
Level I Programming Parameters .....	13
Level II Programming .....	15
Level II Programming Parameters .....	15
Level I and II Default Settings .....	16
System Capacity Inputs .....	17
Flow Diagrams .....	18
Control Valve Diagram .....	20
Systems Diagram .....	21
Troubleshooting .....	22
Notes .....	26

## Introduction

Your Hamilton Beach owner’s manual is designed to assist owners and installers with the installation, operation, and maintenance of your new water-conditioning system. The simplified photo format is designed to assist all aspects of operation.

In the event service or plumbing changes are required, contact your local authorized Hamilton Beach dealer. If further assistance is required, call 800.685.8440.

## Equipment Specifications

Working Pressure	20 psi to 120 psi
Voltage	102 to 132 vac, 60 Hz
Current	50 mA
Transformer	Wall Mount (indoor use only)
Operating Temperature	34° F to 120° F
Humidity	10% to 100%, Condensing Allowed
Service Connections	3/4", 1", 1 1/4" Copper Tube Adapter
Brine Line Connection	3/8" Tubing
Drain Line	1/2" NPT Male
Water Flow	Accurate over range of .5 to 23 gpm

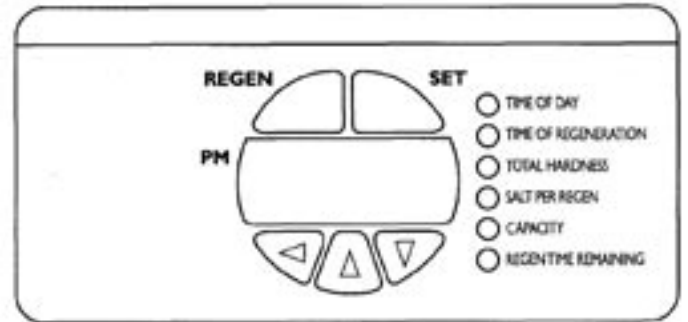

**Figure 1:** Control valve interface.

System Specifications			
		SA-HB-40-DB-CERT	SA-HB-48-DB-CERT
Resin Tank Size		10x44"	12x48"
Resin Volume		1.25 ft <sup>3</sup>	1.50 ft <sup>3</sup>
Refill Controller		0.35 gpm	0.35 gpm
Backwash Controller		2.8 gpm	2.8 gpm
Salt Tank	Size	15x40"	15x40"
	Capacity	450 lbs	450 lbs
Operation Temperature	Min	34°	34°
	Max	120°	120°
Flow Rate		15.2 gpm	18.0 gpm
Pressure Drop		15.0 psi	15.0 psi
Max Flow to Drain		4.0 gpm	3.5 gpm

**Table 1:** System specifications

# Job Specification Sheet

Homeowner. \_\_\_\_\_

Dealer. \_\_\_\_\_

Date of Installation. \_\_\_\_\_

Installers Name. \_\_\_\_\_

Model #. \_\_\_\_\_ Serial #. \_\_\_\_\_

## Water Characteristics

\_\_\_\_\_ Hardness as CaCO<sub>3</sub> (check one \_\_\_\_\_ gpg or \_\_\_\_\_ Mg/L)

\_\_\_\_\_ Iron (ppm)

\_\_\_\_\_ Water pressure (psi)

\_\_\_\_\_ PH

\_\_\_ Yes \_\_\_ No Pressure regulator.

\_\_\_\_\_ Other \_\_\_\_\_, \_\_\_\_\_ Other \_\_\_\_\_.

\_\_\_\_\_ Other \_\_\_\_\_, \_\_\_\_\_ Other \_\_\_\_\_.

# Sizing Information

All Water is treated except: \_\_\_ Front hose bib \_\_\_ Rear hose bib \_\_\_ Kitchen  
 \_\_\_ Toilets \_\_\_ Other \_\_\_\_\_.

Sizing formula: On the average, a person uses 70 gallons of water per day  
 (20 gallons hot water, and 50 gallons cold water).

Example:

Daily usage: 70 gallons per person  
 Family size: x 6 persons  
 Total family daily usage: 420 gallons  
 Hardness: x 20 grains per gallon  
 Total removal per day: 8,400 grains

Actual Usage

Daily usage: 70 gallons per person  
 Family size: x \_\_\_\_\_ persons  
 Total family daily usage: \_\_\_\_\_ gallons  
 Hardness: x \_\_\_\_\_ grains per gallon  
 Total removal per day: \_\_\_\_\_ grains

# Water Conditioning

## Glossary of Terms

Hardness is comprised of dissolved calcium and magnesium. As a general rule water is considered to be extremely hard when over 10 gpg of hardness, hard when 6-10 gpg, mildly hard when 3-6 gpg, slightly hard when 1-2 gpg and soft when 0 gpg.

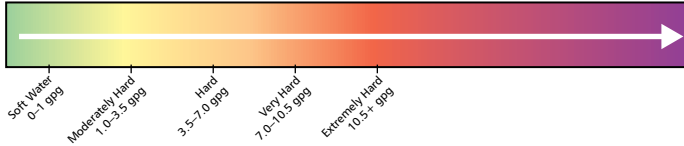

**Measurements:** Your Hamilton Beach water system registers hardness in grains per gallon (gpg). Most water analysis reports register hardness in milligrams per liter (Mg/L) or parts per million (ppm). To convert either Mg/L or ppm to gpg, divide the indicated amount by 17.1.

**Example:** Water report indicates total hardness of 350 Mg/L, divide this number by 17.1 to get the gpg, which would be 20.4 gpg.

**Ion Exchange:** Your water conditioning system utilizes ion-exchange media, also referred to as resin, to effectively remove hardness ions from the water and replace them with sodium ions. Exhausted resin beads are rinsed with a salt solution called “brine.” This causes the resin to exchange hardness ions for the sodium ions, returning the resin to its sodium state.

**Proportionate Brining:** Your Hamilton Beach System utilizes an advanced microprocessor to control the amount of regenerant proportionate to the amount of exhausted resin. It uses enough salt to bring the system back to 100% capacity. The microprocessor also incorporates a variable-reserve feature to enable the system to adjust to patterns of usage, thus maintaining high efficiency.

# Homeowner Maintenance

## Manual Regeneration

Occasionally you may find it necessary to initiate a manual regeneration. This is done by pressing the [REGEN] button on the front of the display. (See Figure 2.) When you press the [REGEN] button, the control performs a full regeneration of the water conditioner immediately.

In the event the system is allowed to run out of salt, it will be necessary to run “Back to Back” regenerations. This can be done easily by pressing the [REGEN] button one time, waiting at least one minute and pressing the [REGEN] button again.

Note: The second regeneration will begin immediately after the first is completed.

“Back to Back” regenerations are necessary if full exhaustion occurs due to low regenerate levels or system malfunction. The system works on a highly efficient proportionate-brining method. When the system is not aware of the lack of proper regenerate(salt) a larger portion of the resin bed becomes exhausted.

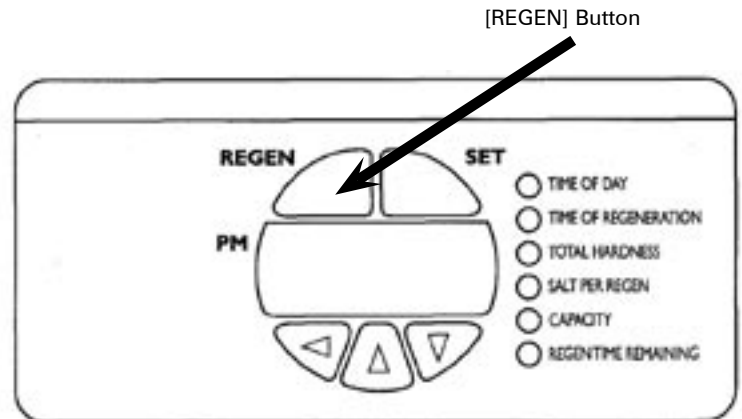

Figure 2: Control valve interface: regeneration button (REGEN).

### Calendar Day Override Feature

Hamilton Beach systems have an optional calendar day override feature. The systems come pre-programmed with this feature turned off. To activate this feature, see Level II Programming instructions. This feature overrides the registered water volume and initiates a regeneration based on the days selected even if there has been 0 water usage registered. This feature is sometimes used if long absences from the home occur. This ensures a freshly regenerated bed of resin and minimizes the chance of resin fouling.

### Regeneration:

Salt is used to regenerate the system. Salt pellets are generally cleaner than extra-course rock salt. **DO NOT** use salt blocks as they may contain vitamins or other undesirable additives. **Add salt to the brine tank when it drops to within 12 inches of the bottom.**

### Dry Brine Tank:

Hamilton Beach Systems use a dry brine tank. Since the system determines the amount of solution necessary to regenerate the exhausted resin, water is sent to the brine tank as part of the regeneration sequence in an amount proportionate to the exhausted resin that needs to be regenerated.

Note: While it is a dry brine tank, you will see approximately 1" of water in the bottom of the tank during normal service. This amount of water is necessary for the proper function of the brine air-check assembly. If water amount exceeds this level while in normal service position, refer to the troubleshooting guide; or contact your local authorized Hamilton Beach dealer or qualified plumbing professional

### Brine Tank Cleaning:

Insoluble materials gradually build up in the salt tank depending on the levels found in the salt. As a general rule, inspect the brine tank once a year when the salt level is low. To clean the tank, disconnect the brine-line connection, rinse out any insoluble build-up, reconnect the brine-line, and add one inch of fresh water. Then totally refill the tank with salt.

### Setting Time Clock:

Your clock should indicate the current time of day, provided the clock is set correctly. The system will clean at the specified time of regeneration.

### Disinfection of Water Conditioners:

The construction materials of the water conditioning system do not contaminate the water supply. However, we recommend that the conditioner be disinfected after installation. Periodic disinfection is recommended for all conditioners. Use the following method of disinfection to clean your system:

- Sodium Hypochlorite 5.25%: Sodium Hypochlorite solutions can be used with polystyrene resin, synthetic gel zeolite, greensand, and bentonites and are available under trade names such as Clorox\*. Adjust the dosage if stronger commercial solutions are used.

The recommended dosage for a 5.25% depends on your system size. Use the following amount depending on your system model:

Model:	SA-HB-40-DB-CERT	.....	1.5 Fluid ounces
	SA-HB-48-DB-CERT	.....	1.8 Fluid ounces

Add the sodium hypochlorite solution to the brine well of the brine tank. Make sure that the brine tank has water in it so the solution is carried into the conditioner. Proceed with manual regeneration. Refer to the Manual Regeneration section on page 6.

\* Clorox is a trademark of the Clorox Co.

### Battery Backup Feature:

Your Hamilton Beach system has a battery backup feature. (See Figure 3.) During a power outage the display will be blank but the microprocessor will continue registering water flow. The system will not initiate regeneration during a power outage; instead it will wait until full power returns.

It is recommended the battery be replaced once a year or after any extended power outage. The battery is a standard 9-volt. Detailed instructions can be found in the programming section on page 12 of this manual.



**Figure 3:** Battery installation for battery backup feature.

## Manual Bypass Valve (Optional)

Your Hamilton Beach system is equipped with a manual bypass valve. (See Figure 4.) This valve is to be used if you want to stop the flow of water through the equipment but still allow untreated water into your home.



Figure 4: Bypass valve.

For example, a bypass valve may be used if a leak occurs in the system or when the homeowner(s) will be gone from the home for an extended period of time.

Note:

It is recommended that the bypass valve knobs be engaged and disengaged (turned in and out of service) once a year to ensure that the O-rings are functioning. This allows the bypass valve to turn more freely if it becomes necessary.

## Pre-Installation Check List

The following items should be checked and verified prior to the installation of the equipment. Under certain circumstances, as indicated, additional procedures or pieces of equipment may be recommended.

- Water Pressure Verification:** A minimum water pressure of 20 psi is required for normal operation. Maximum water pressure is 120 psi.
- Electrical Requirements:** The system includes a 12-volt transformer to be plugged into a standard 110 volt 60 Hz current. If additional cord length is required, a 15 foot extension is available. (AVP-1000907, see pg. 11)
- Drain-Line Connection:** Choose a location close to a drain to put your brine tank. Avoid overhead runs in excess of 25 feet. Drain line must be a minimum of 1/2" inside diameter.

Do not use soft vinyl tubing, 3/8" or smaller tubing. Do not expose tubing to freezing.

When barb drain fittings are used, always use a hose clamp to secure the tubing to the fitting. Do not connect the drain line to the overflow line on the salt storage container. Installation of the drain line should be in accordance with all state and local plumbing codes.

- Installation Site:** When choosing the proper locations for the equipment, consider the following factors:
  - Proximity to drain.
  - Proximity to electrical outlet.
  - Access to plumbing; it is recommended that when possible both hot and cold water be treated with the exception of outside taps. Kitchen cold is optional. Additional equipment may work better with treated water. Consult your dealer for details and the best option for the application. (See Figure 5.)
- Unpacking System:** After removing the system from the box, inspect the system for any concealed damage that may have occurred in shipping. If damage occurred, contact your dealer for details. **Do not install if the system has sustained damage.**

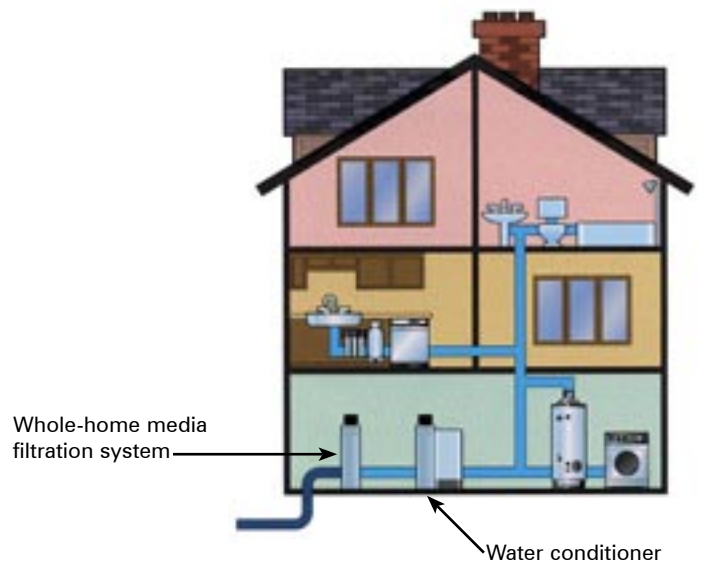

Figure 5: Water-using appliances and fixtures in reference to water-conditioner system installation site.



# Detailed Installation Instructions

## General Installation Warnings

The following general warnings should be observed when installation and/or general service maintenance is performed.

- Plumbing connections should be done in accordance with state and local plumbing codes.
- Do not use with water that is microbiologically unsafe or of unknown quality without adequate disinfection before or after the system.
- Drain lines should be 1/2" minimum for drain line flows up to 7 gpm. Flows above 7 gpm or runs in excess of 20 feet require 3/4" drain line.

**WARNING: Never connect drain line directly into a drain, sewer line or trap. Plumbing code requires installation to allow an air gap\* between the drain line and the wastewater to prevent the possibility of sewage back-siphoning into the conditioner. (See Figure 6.) Sewage backup can have harmful health effects.**

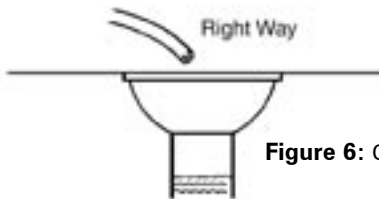

Figure 6: Correct air-gap installation.

\* Plumbing code air gap is one inch above the flood plane.

- All electrical connections must be connected according to local codes. The electrical source must be uninterrupted. Install grounding strap on metal pipes.
- Do not use pipe dope or other types of liquid sealants on any threads. Teflon tape must be used on the drain line 3/4" threads and also on the 3/8" brine-line connections.

Note: Factory has teflon taped these fittings.

- Use caution if soldering inlet, outlet, or drain lines. Excess heat will damage the control valve and/or bypass valve.

- A Brine Tank over-flow line of 1/2" ID 5/8" OD is recommended for the brine tank. This line should run from the barb fitting on the side of the tank to an unobstructed drain. (See Figure 7.)
- Each system comes standard with a high-pressure injector.\* It may be necessary to change the injector (see Figure 8) to match your incoming water pressure. (See Table 2 for injector sizes.)

\*Standard Injector (High Pressure)

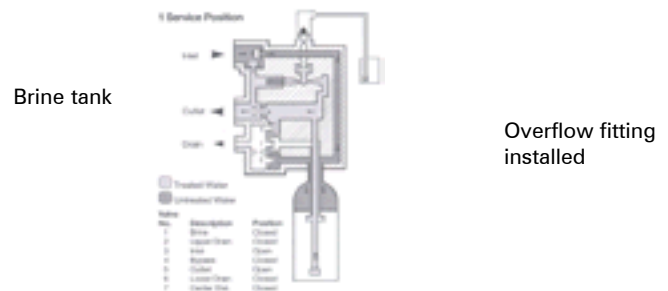

Connect 1/2" (1.3 cm) ID tubing or hose and run to drain.

Figure 7: Brine tank tubing connection with overflow fitting.

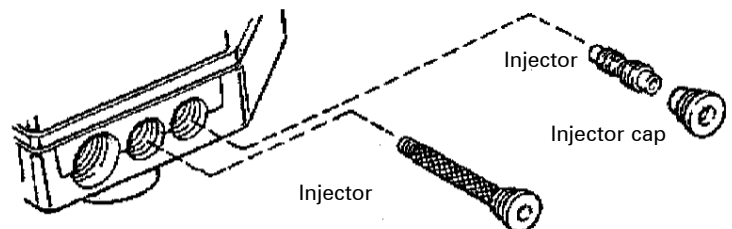

Figure 8: Injector screen and cap installation.

Injector Selection		
Water Pressure	Injector	Part Number
20–60 psi (138–414 bar)		AVP-1032980 (#5 Injector)
61–120 psi (420–827 bar)		AVP-1032977 (#4 Injector)

Table 2: Injector selection based on water pressure.

### *Start-Up Rinsing Procedure (Bypass valve is optional)*

1. With the plumbing, drain line, and overflow connections completed, slowly open the water supply allowing the lines to pressurize.

Note: The optional bypass should still be in bypass mode as shown in Figure 9.

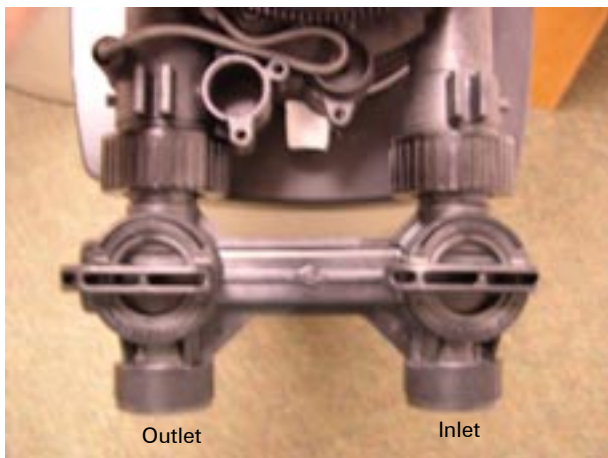

Figure 9

2. With the control valve unplugged, manually advance the control valve by depressing the drive gear and rotating the main system gear to the purge position. (See Figure 10.)



Figure 10

3. Slowly open the inlet valve (only) on the bypass valve allowing the system to pressurize. It is normal to hear air blowing to the drain during this procedure.

Once the air clears and water begins to run to the drain, open the inlet valve (only) to the full open position and allow the water to run to the drain in purge for a minimum of 20 minutes. (See Figure 11.)

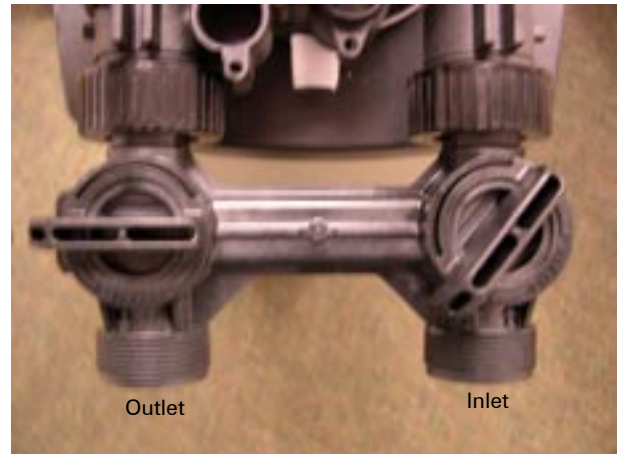

Figure 11

4. After the 20-minute purge cycle, manually advance the main gear to the backwash cycle and allow to run for a minimum of 10 minutes. (See Figure 12.)

Note: when advancing the main gear manually while under water pressure it is normal for the gear to encounter resistance as the valve chambers depressurize. If resistance occurs, pause five seconds to allow the valve to depressurize before advancing to the next step.

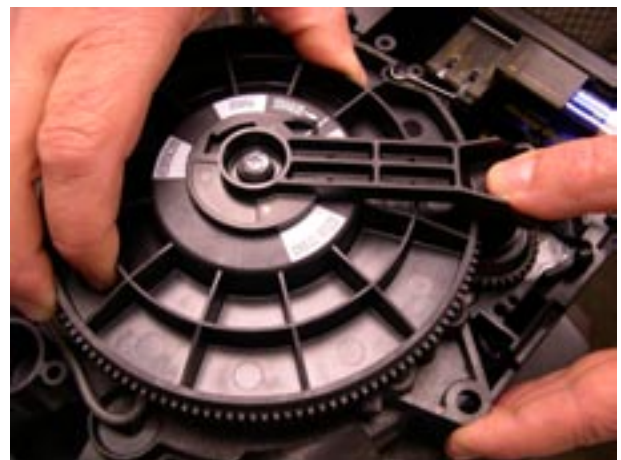

Figure 12

5. After the ten-minute backwash cycle, manually advance the control valve to the brine refill position for ten minutes allowing water to flow into the brine storage tank. (See Figure 13.)



Figure 13

Once water begins to flow into the tank fill the brine tank with a minimum of 100 lbs of salt pellets.

6. After the ten-minute refill time, manually advance the control valve to the service position. (See Figure 14.)



Figure 14

7. Plug in the control valve. (See Figure 15.)



Figure 15

8. If it is necessary to extend the length of the transformer cord, an optional 15 foot (4.6-m) extension cord is available, (See Figure 16), or the cord may be spliced as follows:

- a. Strip insulation from wire  $\frac{5}{16}$  inch (7.87 mm) from wire end.
- b. Insert stripped wire into barrel of connector and crimp. For best results, crimp twice per wire as shown in Figure 17 .

Neither splice connections nor extension wire are supplied. They are available at hardware or electrical stores.



Figure 16  
(AVP-1000907)

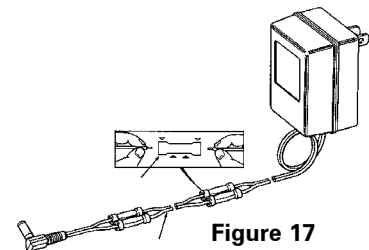

Figure 17

### ***Battery Backup Feature***

Your Hamilton Beach softening system has a battery backup feature that allows the control to continue monitoring water flow and maintain the proper time of day during short power outages. The control uses a standard 9-volt battery (not supplied).

During a power outage, the display will be turned off and the motor will not run, but the control will continue to monitor water flow. If power is out and a regeneration is needed, the regeneration will be delayed until power is restored. If power is lost during the regeneration, the control will resume the regeneration when power is restored.

While batteries may last for over a year, the factory recommends replacing the battery every year. During an interruption in power supply, a typical new 9-volt alkaline battery provides approximately two days of power for the control. Older batteries and those exposed to temperature over 75° F (23.9° C) provide power for shorter periods of time.

The control can be operated without a battery, but the control will not measure water usage or time while the power is off. The control will save all important operating information and programming data during a power outage. No reprogramming is necessary.



**Figure 18**

Note: It is recommended that the battery be replaced every year or after any extended power outage.

To install a battery:

1. Remove the control valve cover.
2. The battery pocket is located in the upper left corner of the control as shown in Figure 18.
3. Insert the battery, matching up negative and positive posts.

### ***Programming the Control Valve***

You are now ready to continue programming the control. Programming can be done in both Level I and Level II. Accompanying tables are included for selecting the correct settings for each level .

Note: The system has been pre-programmed with default settings based on model number and ultra-high efficiency settings at a water hardness of 15 grains per gallon. While the system may operate with these settings, the following Level I & II settings may need to be changed to meet the actual operating conditions and achieve maximum system capacity and salt efficiency.

## Level I Programming

Parameters	
P1	Time of day
P2	Time of regeneration
P3	Water hardness (grains per gallon—gpg)
P4	Salt usage per regeneration (lbs)
P5	System capacity (Kg)

**Table 3:** Level I programming parameters overview.

Default settings for models:  
 SA-HB-40-DB-CERT (40DB)  
 SA-HB-48-DB-CERT (48DB)  
 (Ultra-high efficiency settings)

Setting	Description	40DB	48DB
P1	Time of day	Set to current time of day	
P2	Time of regeneration	2 a.m.	2 a.m.
P3	Water hardness	Set in field	Set in field
P4*	Salt usage	3.0 lbs	3.6 lbs
P5	System capacity	14.1 Kg	15.2 Kg

**Table 4:** Level I programming default settings.

\* Default settings are representative of ultra-high efficiency.

Level I Settings are identified as those that have an LED indicator on the front panel. The green indicator illuminates next to the name of the active control setting. (See Figure 19.)

Pressing the down arrow [↓] button displays the Level I settings in order. By continuing to press the down arrow [↓] button, the settings start over beginning with the time of day. Pressing the up arrow [↑] button displays the settings in reverse order.

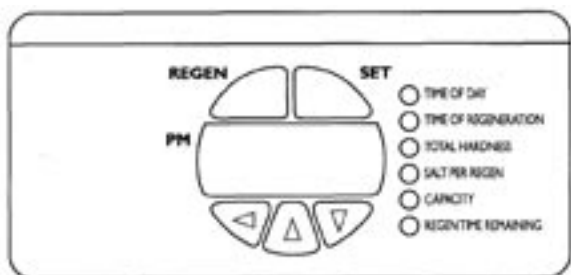

**Figure 19:** Control valve interface.

## Level I Programming Parameters

P1	Time of Day AM or PM <u>Ranges:</u> 1:00 to 12:59 or 00:00 to 23:59 <u>Minimum Increments:</u> 1 Min. <u>Units of Measure:</u> Hours & Minutes <u>Range:</u> Depends on the value selected for P13
P2	Time of Regeneration <u>Ranges:</u> 1:00 to 12:59 a.m. or p.m, 00:00 to 23:59 <u>Minimum Increments:</u> 1 Min. <u>Units of Measure:</u> Hours & Minutes <u>Range:</u> Depends on the value selected for P13
P3	Water Hardness Setting <u>Range:</u> 3 to 250 (grains per gallon) gpg / 30 to 2500 (milligrams per liter) Mg/L <u>Minimum Increments:</u> 1 for (gpg), 10 for (Mg/L) <u>Units of Measure:</u> Grains per gallon (gpg) / Milligram per liter (Mg/L) <u>Range:</u> Unit of measure depends on the value selected for P12. Test water hardness (compensated hardness) and enter that value.
P4	Salt Amount (maximum) <u>Ranges:</u> 0.5 to 99.5 (pounds) or 0.1 to 25.5 (kilograms) <u>Minimum Increments:</u> 0.5 (pounds) or 0.1 (kilograms) <u>Units of Measure:</u> Pounds or Kilograms <u>Range:</u> Unit of measure and default depends on value selected for P12.
P5	System Capacity <u>Ranges:</u> 0.1 to 140 Kgr or 0.01 to 14.0 Kgr <u>Minimum Increments:</u> 0.1 Kgr or 0.01 Kgr <u>Units of Measure:</u> Kgr or Kilograms <u>Range:</u> Depends on value selected for P12

## Changing the Settings

To change the settings press the [SET] button on the far right. The digit of the display starts flashing. If you want to change this number, press the up arrow [↑] button to increase the number or the down arrow [↓] button to decrease the number. To skip the number without changing, press the left arrow [←] button. When you reach the far left digit, pressing the left arrow [←] button will return you to the far right digit.

**Note:** If you press and hold either the up or down arrow [↑] [↓] button for more than 1 second, the flashing number will increase or decrease at ten counts per second.

When the number is correct, press the left arrow [←] button. The far right digit stops flashing and the next digit to the left starts flashing.

You can only change the flashing number. Continue changing numbers until you reach the desired setting. Press the [SET] button. The numbers stop flashing and the control accepts the new setting. After approximately 30 seconds, the control starts alternating the display between Time of Day and Capacity.

**Note:** If the new setting is not accepted because it was outside the allowable range, the old value will be displayed. Refer to the table guides for the correct settings. (Default settings can be found on Table 6, on page 15.)

## Time of Day

Press the [SET] button. The display will show the Time of Day with the minutes digit blinking. If you want to change this number, press the up arrow [↑] button to increase the number or the down arrow [↓] button to decrease the number.

To skip the number without changing, press the left arrow [←] button. The first number stops flashing and the next number starts flashing. You can only change the flashing number. When you have reached the far left digit, pressing the left arrow [←] button returns you to the far right digit. Continue changing numbers until you reach the desired setting. Press the [SET] button again to enter the value.

## Time of Regeneration

The next value displayed is the Time of Regeneration, which is similar to Time of Day programming. It has a default setting of 2:00 a.m. If 2:00 a.m. is acceptable, press the down arrow button [↓].

If this is not acceptable, press the [SET] button and change the numbers. Press the [SET] button again to enter the value.

## Water Hardness

The next setting displayed is the Water Hardness in grains per gallon (gpg). It is recommended that a water test be performed at the time of installation. This Hamilton Beach is designed to run on one water source. If multiple water sources are used, it will be necessary to change the water hardness settings to match the current water source.

The default setting is 15 grains per gallon of water hardness. If this is not accurate, press the [SET] button and enter a new value. U.S. settings allow any value between 3 and 250 grains per gallon. Metric settings allow any value between 30 and 2500 milligrams per liter. Press the [SET] button again to enter the new value.

## Salt Amount

Capacity is the next value displayed and is expressed in Kilograins (Kgr).

The pre-set default values for each model are listed in Table 5. To change these values, press the [SET] button and enter a new value. Any value between 0.1 and 14.0 Kilograins is allowed.

**Note:** If the calculation for the system capacity exceeds 9999 gallons (99.99 cubic meters) (P5, Capacity, divided by P3, Hardness), the control will display 9999 for capacity until the water usage has dropped the remaining capacity below that number. When water is flowing through the system, the colon in the Time of Day display will blink.

Salt Settings (Ultra-High Efficiency Settings)		
Model	Capacity Default	Salt Default
SA-HB-40-DB-CERT	14.1 Kgr	3.0 lbs
SA-HB-48-DB-CERT	15.2 Kgr	3.6 lbs

**Table 5:** Salt settings to obtain ultra-high efficiency.

You have now finished Level I programming. The display will alternate between the Time of Day and Capacity if no keys are pressed for 30 seconds. The Capacity value displayed is the volume remaining in gallons (cubic meters for metric) before a regeneration is needed.

## Level II Programming

The Level II programming has been programmed by the manufacturer to the settings in Table 6. The changing of preset values can be done at this time. Refer to Level II programming parameters in Table 6 for options.

**Note:** It is not recommended that homeowners change these values without checking with local water-treatment professional for details. Incorrect programming can cause system malfunction and the possible need for a field service call to reprogram the system. **System programming is not covered under warranty.**

To access Level II programming, simultaneously hold down the up [↑] and down [↓] arrows. This will allow you to enter Level II settings P6 through P19. (See Table 6.)

## Level II Programming Parameters

Level II Programming Parameters					
Parameter	Description	Range	Minimum Increments	Units of Measure	Notes
P6	Refill controller	1–99	1	gpm	.35 gpm, both models
P7	Brine draw value	1–99	1	Minutes	15, both models
P8	Not used	n/a	n/a	n/a	n/a
P9	Backwash time	3–30	1	Minutes	Skip this parameter to accept the default or enter a value
P10	Slow rinse time	8–125	1	Minutes	SA-HB-40-DB-CERT = 67 SA-HB-48-DB-CERT = 80
P11	Fast rinse time	2–19	1	Minutes	Skip this parameter to accept the default or enter a value
P12	Units of measure	0–1	1		0 = U.S. 1 = Metric Skip this parameter to accept the default (U.S.)
P13	Clock mode	0–1	1		0 = 12-hour clock 1 = 24-hour clock Skip this parameter to accept the default (12-hour)
P14	Calendar override	0–30	1	days	0 = no calendar override Skip this parameter to accept the default (no override)
P15	Reserve type	0–3	1		0 = variable reserve
P16	Fixed reserve capacity or initial average value	0–70	1	percent of capacity	Description depends on the value entered for P15 (Reserve type). Skip this parameter to accept the default.
P17	Operation type	0–1	1		0 = Not used 1 = 5-cycle counter current
P18	Salt / capacity change lock out	0–1	1		0 = none 1 = salt / capacity change locked out Skip this parameter to accept the default (no lock out)
P19	Factory defaults	DO NOT CHANGE	1		Loads in factory default values. DO NOT CHANGE THIS PARAMETER.

**Table 6:** Level II programming parameters.

## ***Level I and II Default Settings***

The following table represents preset values programmed into the systems at the factory for both levels I and II for the model shown. (See Table 7.)

<b>Level I Parameters</b>			
<b>Name</b>	<b>Description</b>	<b>SA-HB-40-DB-CERT</b>	<b>SA-HB-48-DB-CERT</b>
P1	Time of day	Set in field	Set in field
P2	Time of regeneration	2:00 a.m.	2:00 a.m.
P3	Hardness	Set in field	Set in field
P4	Salt amount	3.0 lbs	4.0 lbs
P5	Capacity	14.1 Kgr @ 3.0 lbs of salt	15.2 Kgr @ 3.6 lbs of salt
<b>Level II Parameters</b>			
P6	Refill controller	0.35 gpm	0.35 gpm
P7	Brine draw value	3.0 lbs @ 7 min w/ 5 bump injector 7.5 lbs @ 26 min w/ 4 bump injector 15.0 lbs @ 51 min w/ 4 bump injector	4.0 lbs @ 9 min w/ 5 bump injector 9.0 lbs @ 31 min w/ 4 bump injector 18.0 lbs @ 61 min w/ 4 bump injector
P8	Not used	n/a	n/a
P9	Backwash time	3.9 min	3.9 min
P10	Slow rinse time	75.5 min @ 3.0 lbs with 5 bump injector 62.0 min @ 7.5 lbs with 4 bump injector 57.0 min @ 15.0 lbs with 4 bump injector	75.5 min @ 3.0 lbs with 5 bump injector 62.0 min @ 7.5 lbs with 4 bump injector 57.0 min @ 15.0 lbs with 4 bump injector
P11	Fast rinse time	3.5 min	3.5 min
P12	Units of measure	0	0
P13	Clock mode	0	0
P14	Calendar override	0	0
P15	Reserve type	0	0
P16	Fixed reserve capacity or initial average value	n/a	n/a
P17	Operation type	1	1
P18	Salt / capacity change lock out	0	0
P19	Factory defaults	9	9

**Table 7:** Level I and II programming default settings.



# System Capacity Inputs

Salt Settings and Capacity (Kgr)		
Lbs of Salt	SA-HB-40-DB-CERT	SA-HB-48-DB-CERT
3.0	14.1 <sup>40</sup>	n/a
3.6	15.5	15.2 <sup>48</sup>
4.0	16.5	15.5
5.0	19.0	18.0
6.0	22.0	21.0
7.0	24.0	23.5
7.5	24.4 <sup>40</sup>	24.3
8.0	25.6	25.0
9.0	27.9	26.1 <sup>48</sup>
10.0	30.0	30.0
11.0	31.9	31.5
12.0	33.6	33.0
13.0	35.1	34.0
14.0	36.4	35.2
15.0	37.1 <sup>40</sup>	36.0
16.0	38.4	37.0
17.0	39.1	38.0
18.0	39.6	39.8 <sup>48</sup>
19.0	39.9	41.0
20.0	40.0	41.5
21.0	n/a	42.0
22.0	n/a	43.0
23.0	n/a	44.0
24.0	n/a	45.2
25.0	n/a	45.9
26.0	n/a	46.5
27.0	n/a	47.2
28.0	n/a	48.0

**Table 8:** System capacity by pounds of salt.

<sup>40</sup> SA-HB-40-DB-CERT certified capacity at salt setting

<sup>48</sup> SA-HB-48-DB-CERT certified capacity at salt setting

Note: The 3.0 lbs salt setting (40 DB model) and the 3.6 lbs salt setting (48 DB model) are certified using the 5 bump injector. The 7.5 lbs (40 DB), 15 lbs (40 DB), 9 lbs (48 DB), and 18 lbs (48 DB) are certified using the 4 bump injector.

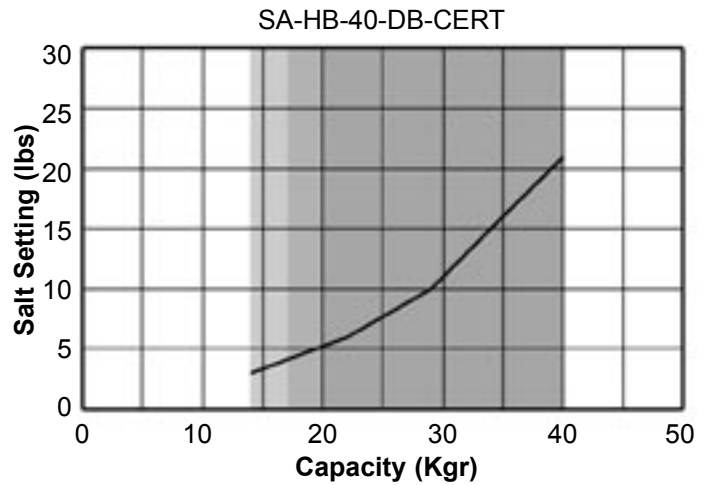

Figure 19

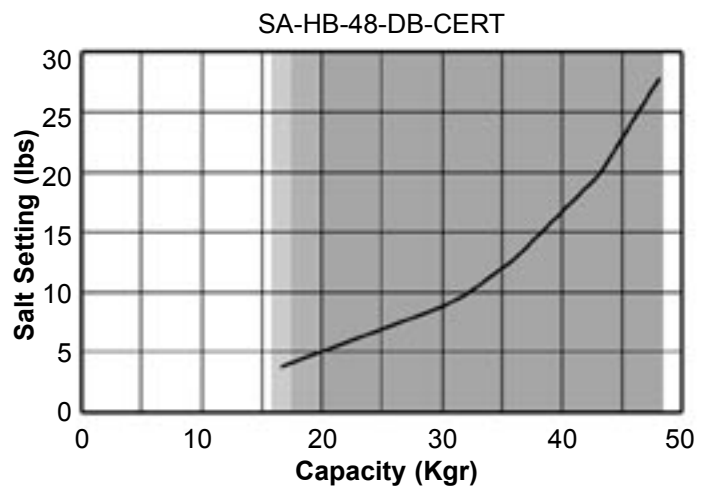

Figure 20

# Flow Diagrams

1 Service Position

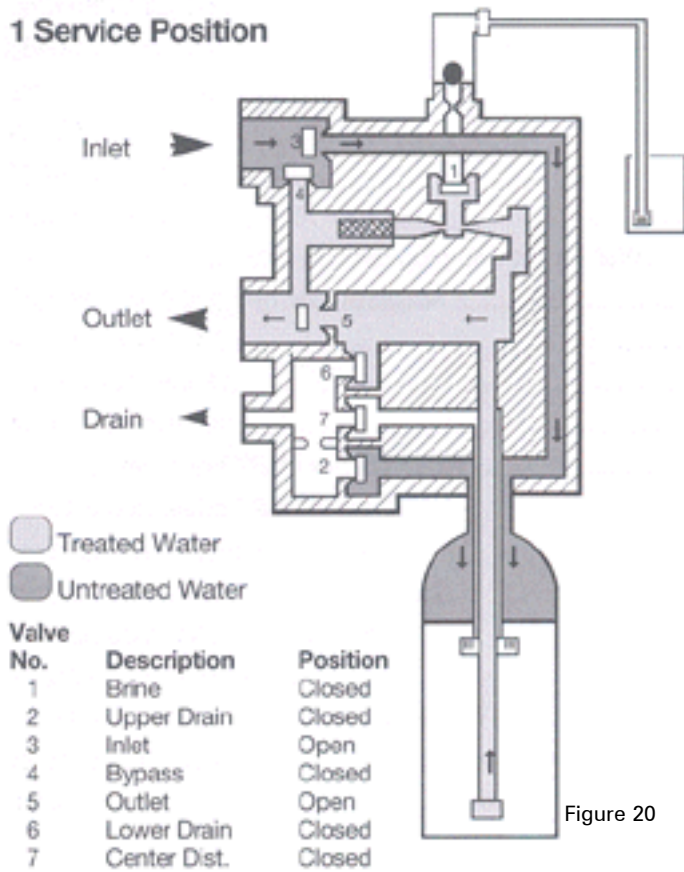

Figure 20

2 Refill Position

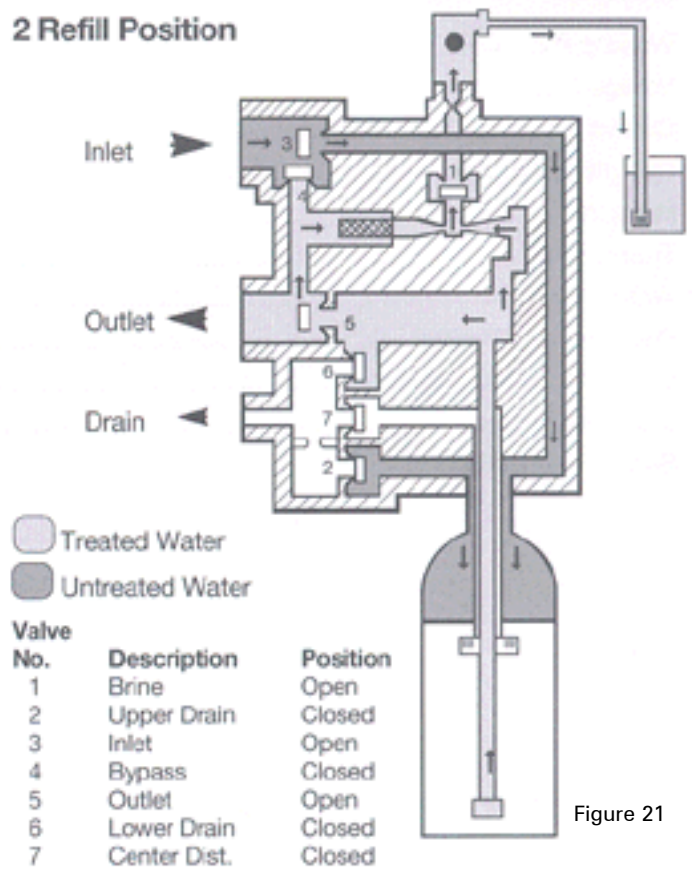

Figure 21

3 Brine Draw Position

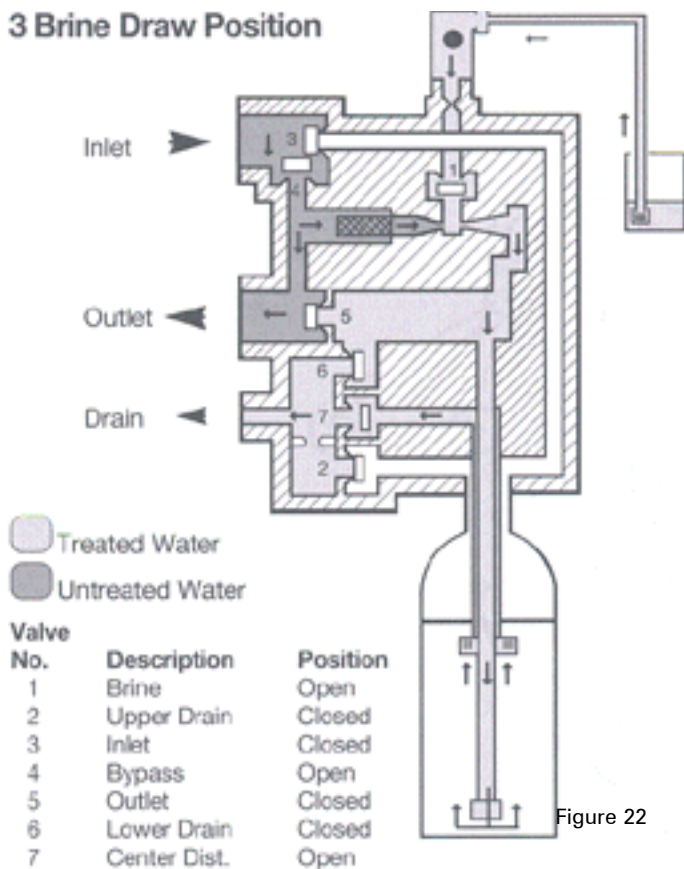

Figure 22

4 Slow Rinse Position

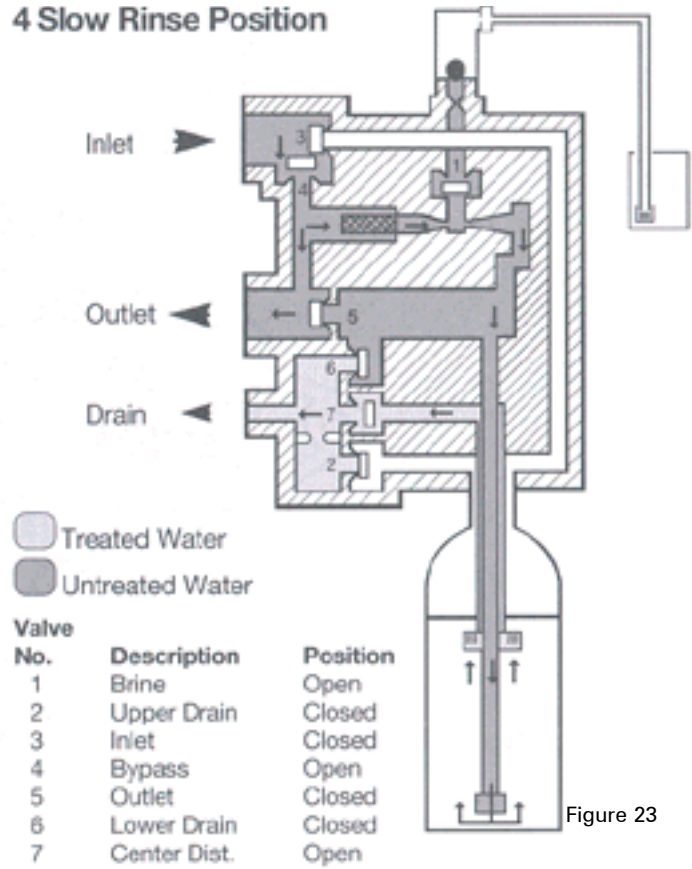

Figure 23

5 Backwash Position

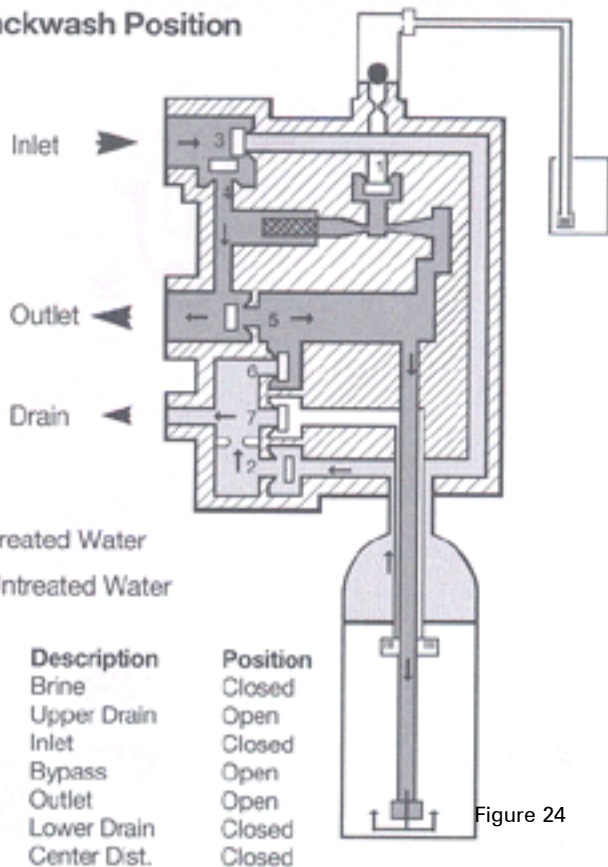

Figure 24

6 Fast Rinse Position

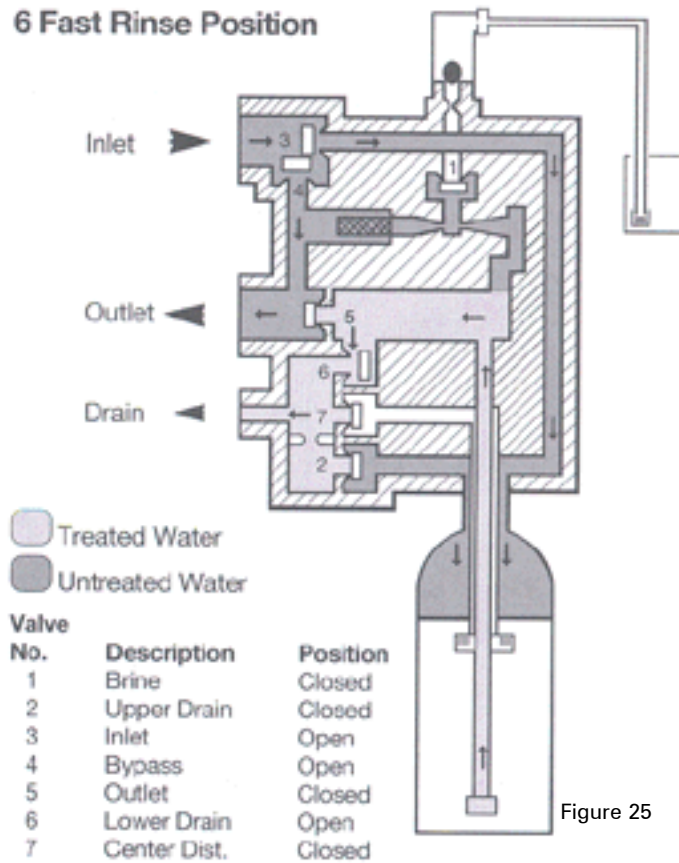

Figure 25

Valve Disc Identification

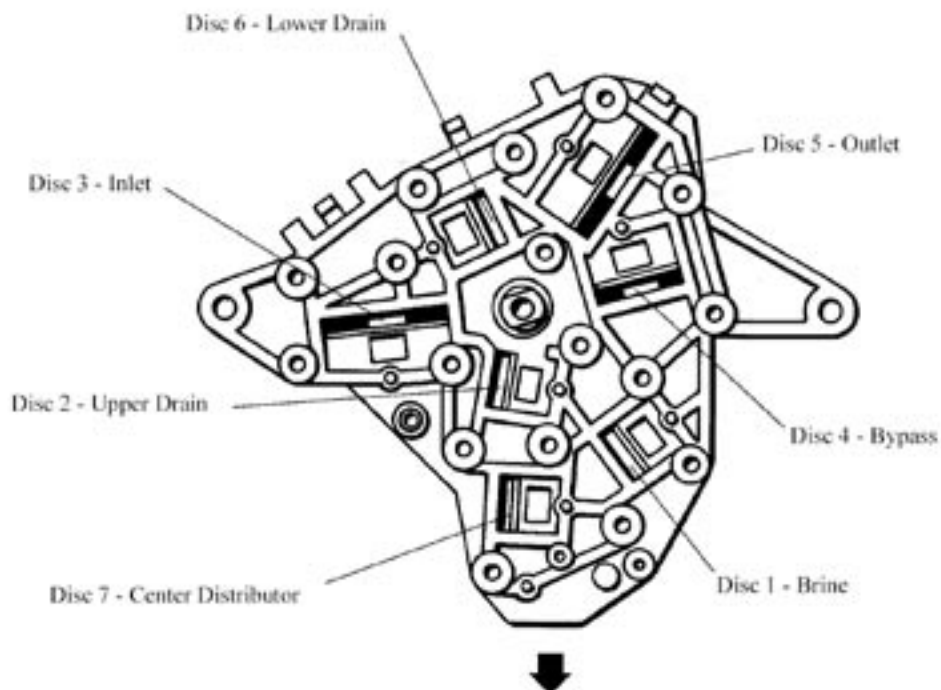
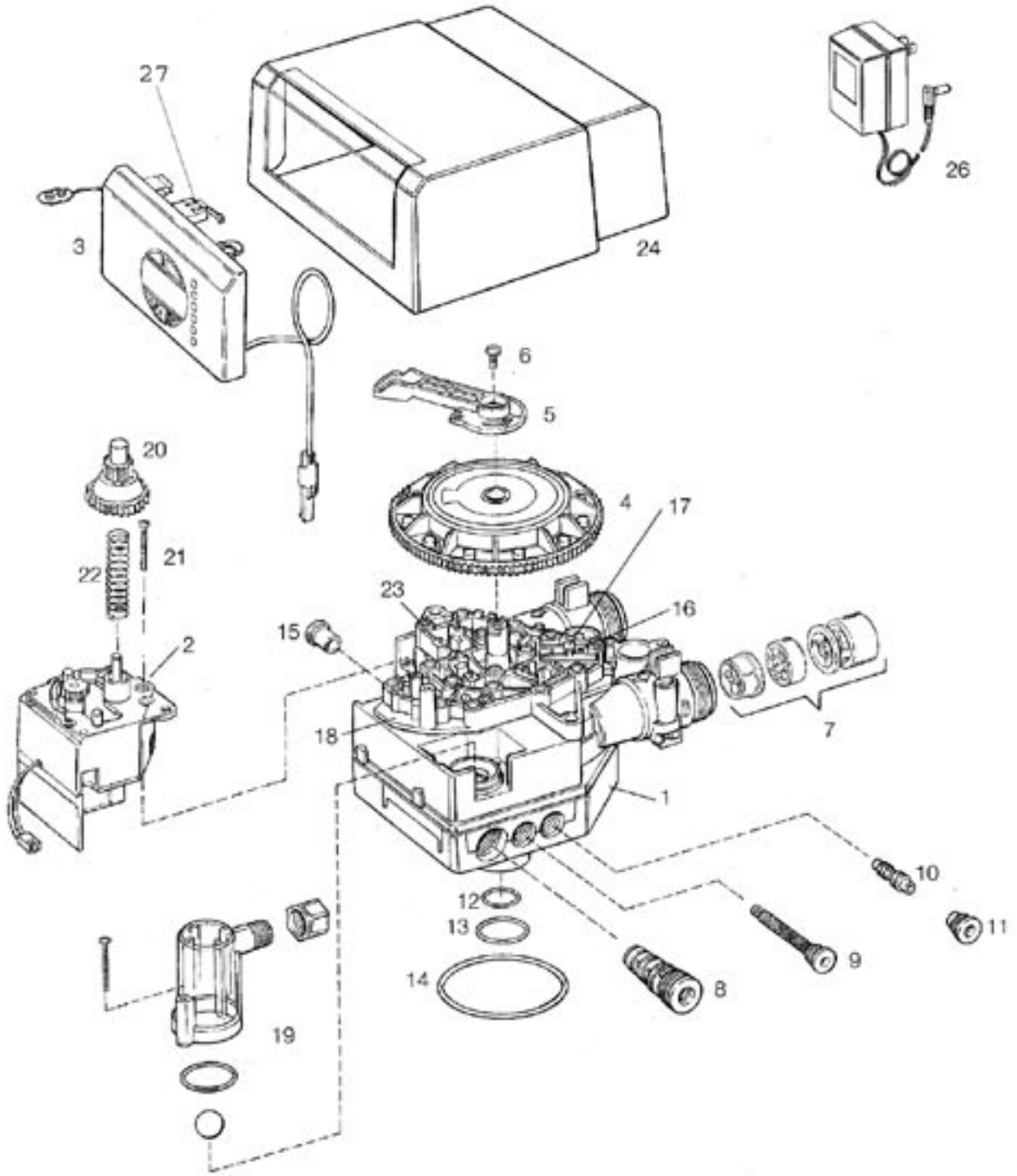

Figure 26

# Control Valve Diagram



## Control Valve Parts

Code	Part Number	Description	Qty
1	AVP-1034448	Valve Body Assembly	1
2	AVP-1034347 AVP-1034346	Motor Drive Assembly, 60 Hz Motor Drive Assembly, 50 Hz	1
3	AVP-1034424	Control Assembly, 1000i	1
4	AVP-1034362 AVP-1034363	Cam Gear, 1100 English Cam Gear, 1100 Symbols	1
5	AVP-1032881	Bracket	1
6	AVP-1005001	Screw, 10-32 x 1/2 inch	1
7	AVP-1033670	Turbine Group	1
8	AVP-1034340	10-inch Brine/backwash Control	1
9	AVP-1032988	Injector Screen Assembly	1
10	AVP-1032977 AVP-1032980	Injector Assembly, 4 Bumps Injector Assembly, 5 Bumps	1
11	AVP-1032985	Injector Cap Assembly	1
12	AVP-1010140	O-Ring, 1 x 1-1/4 x 1/8 inch	1
13	AVP-1010129	O-Ring, 1-5/16 x 1-1/2 x 3/32"	1
14	AVP-1010429	O-Ring, 3-1/8 ID, 3/16 inch	1
15	AVP-1009056	Cap plug, Black, 1/2 inch	1
16	AVP-1040717	Valve Disc Kit	1
17	AVP-1001580	Valve Disc Spring	11
18	AVP-1034360	Top Plate Assembly with Springs	1
19	AVP-1032416	Air Check Kit	1
20	AVP-1032250	Drive Gear	1
21	AVP-1006002	Screw, 8-18 x 1-1/2 inch	2
22	AVP-1031118	Spring	1
23	AVP-1006093	Top Plate Screw	17
24	AVP-1033998	Black Cover	1
25	Not Used	—	—
26	AVP-1000811	Transformer, 120V	1
27	AVP-1000906	Micro Switch	1

# Systems Diagram

# Systems Parts

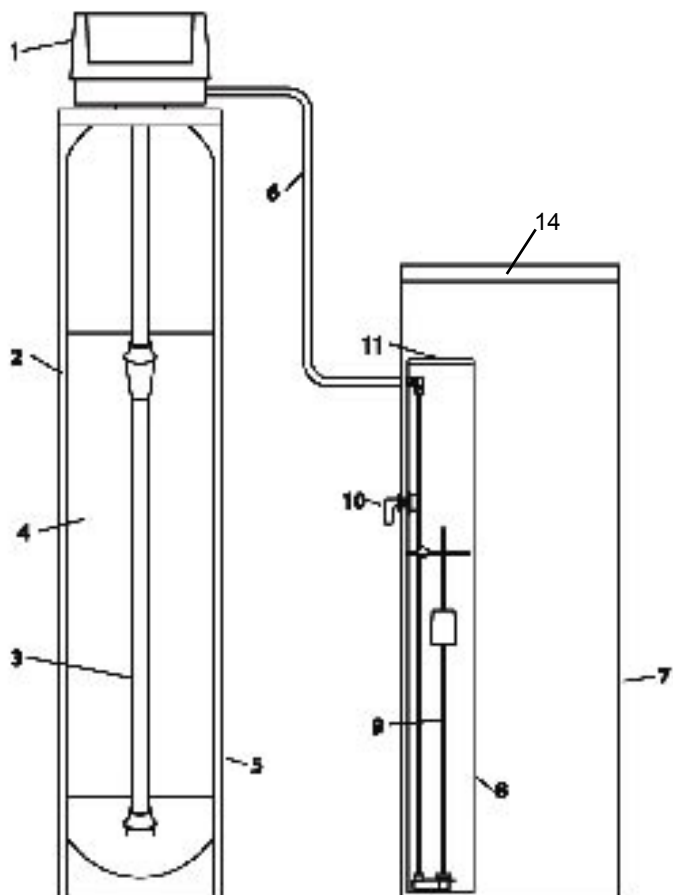

## SA-HB-40-DB-CERT

Code	Part Number	Description	Qty
1	AUV-1050643	Hamilton Beach Valve	1
2	MTK-SP-1044	10x44 Mineral Tank	1
3	DST-1080	Hamilton Beach Distributor, 10x44	1
4	MP-TECH 40DB	Resin Media, 1.25 cf	1
5	JKT-1325	Mineral Tank Jacket	1
6	TB-1085	Brine Line, 3/8"(per foot)	5
7	BTC-1214	Brine Tank w/ Lid, Hamilton Beach	1
8	BTC-1093	Brine Well	1
9	BTC-1054	Hamilton Beach Float Assembly	1
10	BTC-1000	Overflow Assembly	1
11	BTC-1303	Brine Well Cap	2
12		Bypass Tail Kit	1
	BP-A-1001606	3/4" Copper Tail Kit	
	BP-A-1001670	1" Copper Tail Kit	
	BP-A-1041210	1 1/4" Copper Tail Kit	
	BP-A-1001613	3/4" CPVC Tail Kit	
	BP-A-1001614	1" CPVC Tail Kit	
13	BP-A-1040930	Hamilton Beach Bypass	1
14	BTC-1423	Brine Tank Lid	1

## SA-HB-48-DB-CERT

Code	Part Number	Description	Qty
1	AUV-1050643	Hamilton Beach Valve	1
2	MTK-SP-1248	12x48 Mineral Tank	1
3	DST-1085	Hamilton Beach Distributor, 12x48	1
4	MP-TECH 48DB	Resin Media, 1.5 cf	1
5	JKT-1325	Mineral Tank Jacket	1
6	TB-1085	Brine Line, 3/8"(per foot)	5
7	BTC-1214	Brine Tank w/ Lid, Hamilton Beach	1
8	BTC-1093	Brine Well	1
9	BTC-1054	Hamilton Beach Float Assembly	1
10	BTC-1000	Overflow Assembly	1
11	BTC-1303	Brine Well Cap	2
12		Bypass Tail Kit	1
	BP-A-1001606	3/4" Copper Tail Kit	
	BP-A-1001670	1" Copper Tail Kit	
	BP-A-1041210	1 1/4" Copper Tail Kit	
	BP-A-1001613	3/4" CPVC Tail Kit	
	BP-A-1001614	1" CPVC Tail Kit	
13	BP-A-1040930	Hamilton Beach Bypass	1
14	BTC-1423	Brine Tank Lid	1

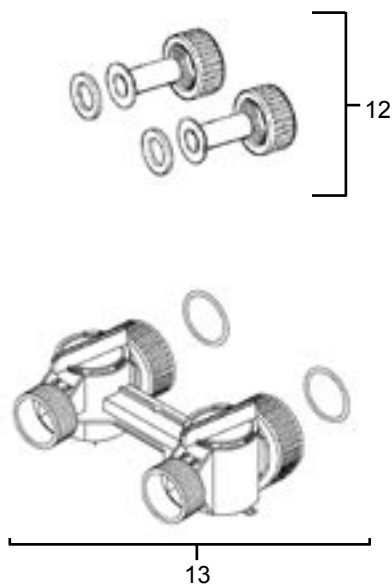

# Troubleshooting

## Manual Indexing for Each Regeneration

The control valve may be manually indexed to each regeneration position as follows:

1. Remove the control valve cover.
2. Press down on the top of the drive gear to disengage the cam gear. (See Figure 9 on page 10.)
3. With the cam gear disengaged, rotate the cam gear counterclockwise to the various positions, using the same steps as the Start-up Rinse procedure (see page 10).

The control valve may also be operated in a fast mode for testing the control. To activate the fast mode, follow steps 1 and 2 outlined above to disengage the cam gear. When the cam gear is disengaged, it should be advanced slightly in a counterclockwise direction.

The switch will then activate the motor to cause the cam gear to advance through all the cycles in about 30 minutes. The control will not recognize a fast mode as a regeneration. Manual regenerations can be initiated only by pressing the manual regeneration switch on the face of the control.

## Errors

The Hamilton Beach System continuously monitors itself and displays an error message if it detects something wrong.

When an error is detected, the display shows the letters “Err” with a number from 1 to 4. The table below lists Err numbers, a description of each error, the cause of the error, and the solutions. (See Table 9.)

To clear the error from the display, press any button on the control. If the error still exists, the control will display the error message again after 30 seconds.

For additional troubleshooting information, see the troubleshooting guide (Table 10), which may help determine the problem and potentially solve the problem. If consulting the troubleshooting guide fails to resolve the problem, contact your authorized Hamilton Beach dealer or qualified plumbing professional. If further assistance is required, call 800.685.8440.

<b>Hamilton Beach Error Detection Codes</b>			
<b>Code</b>	<b>Description</b>	<b>Cause</b>	<b>Solution</b>
Err 1	Electronics failure	Control settings need reprogramming	Press any key to load default values. Refer to “Programming the Hamilton Beach 1100 Control”
Err 2	Improper start of regeneration (limit switch open when it should be closed)	Valve cam gear has been manually rotated during a regeneration	Press any key to clear the alarm (Alarm automatically clears at “TIME OF REGEN”)
		Valve cam gear has been manually rotated out of “service” position	The control will turn the motor on and drive the cam gear to the proper location
		Faulty motor	Replace motor assembly
		Faulty motor drive	Replace motor assembly
		Faulty switch	Replace switch
Err 3	Improper finish of regeneration (limit switch closed when it should be open)	Valve cam gear has been manually rotated out of “service” position	The control will turn the motor on and drive the cam gear to the proper location
		Faulty motor	Replace motor assembly
		Faulty motor drive	Replace motor assembly
		Faulty switch	Replace switch
Err 4	Improper control settings (one or more settings out of the allowable range)	One or more settings is out of the allowable range	Hardness: Adjust range (3–250) Capacity: Adjust range (0.1–140.0) Refill control: Adjust range (see table 4) Brine draw value: Adjust range (see table 4)

**Table 9:** Error-detection codes.

Troubleshooting Procedures		
Problem Description	Possible Cause	Solution
• Capacity display stays at “9999” even though there is water usage	Total system capacity was calculated to be a value greater than 9999	As the water usage continues, the remaining capacity will drop below 9999—then other values will be shown
• Control does not respond to [REGEN] button	Button is not active in the programming mode	Refer to the regeneration section
• Control does not display time of day	Transformer is unplugged	Connect power
	No electric power at outlet	Repair outlet or use a working outlet
	Defective transformer	Replace transformer
	Defective circuit board	Replace control
• Control does not display correct time of day	Outlet operated by a switch	Use an outlet not controlled by a switch
	Power outage	Reset time of day and replace battery
• No water flow display when water is flowing (colon doesn’t blink)	Bypass valve in “bypass” position	Shift bypass valve into “service” position
	Meter probe disconnected or not fully connected to meter housing	Fully insert probe into meter housing
	Restricted meter turbine rotation due to foreign material in meter	Remove meter housing, free up turbine and flush with clean water. Turbine should spin freely. If not, refer to the water meter maintenance section
	Defective meter probe	Replace control
	Defective circuit board	Replace control
• Control display is frozen at REGEN TIME REMAINING	Back to back regenerations were requested	Refer to manual regeneration section
• Control regenerates at the wrong time of day	Power outages	Reset time of day to correct time of day and replace battery
	Time of day set incorrectly	Reset time of day to correct time of day
	Time of regeneration set incorrectly	Reset time of regeneration
• Cam gear stalled in regeneration cycle	Motor not operating	Replace motor assembly
	Motor runs backwards	Replace motor assembly
	No electric power at outlet	Repair outlet or use a working outlet
	Incorrect voltage or frequency (Hz)	Replace timer and/or transformer with one of correct voltage and frequency
	Broken gear	Replace gear
	Defective switch	Replace switch
	Binding of cam gear	Remove foreign object obstruction from valve discs or cam gear
	Water pressure greater than 125 psi during regeneration	Install pressure regulator to reduce pressure
	Defective circuit board	Replace control
• Continuous regeneration. Cam gear does not stop at the end of regeneration	Defective switch	Replace switch
• Control does not regenerate automatically or when [REGEN] button is depressed	Transformer unplugged	Connect power
	No electric power at outlet	Repair outlet or use working outlet
	Defective motor	Replace motor assembly
	Defective switch	Replace switch

Table 10: Troubleshooting procedures for most common problems.



## Troubleshooting

Problem Description	Possible Cause	Solution
<ul style="list-style-type: none"> <li>Control does not regenerate automatically but does regenerate when [REGEN] button is depressed</li> </ul>	If water flow display is not operative, refer to item 5 (“No water flow display when water is flowing”) in this table	Refer to item 5 (“No water flow display when water is flowing”) in this table
	Incorrect hardness and capacity settings	Set new control values—Refer to programming section
	Defective circuit board	Replace control
<ul style="list-style-type: none"> <li>Run out of soft water between regenerations</li> </ul>	Improper regeneration	Repeat regeneration making certain correct salt dosage is used
	Fouled resin bed	Use resin cleaner
	Incorrect salt setting	Set salt setting to proper level—refer to the programming section
	Incorrect hardness or capacity settings	Set to correct values—refer to the programming section
	Water hardness has increased	Set to new value—refer to the programming section
	Restricted meter turbine rotation due to foreign material in meter housing	Remove meter housing, free up turbine, and flush with clean water. Turbine should spin freely—if not replace meter
	Water usage below 1/5 gallon per minute	Repair leaky plumbing and/or fixtures
	Brine draw value from table 4 is incorrect	Set correct brine draw value
	Incorrect salt type, or use of grid plate (salt shelf)	Do not use block salt or grid plate (salt shelf) in brine tank
<ul style="list-style-type: none"> <li>Control does not draw brine</li> </ul>	Low water pressure	Increase water pressure (20 psi at conditioner)
	Restricted drain line	Remove obstruction
	Injector or injector screen is plugged	Clean injector and screen—refer to the “Cleaning the Injector / Injector Screen” section
	Injector defective	Replace injector and cap
	Valve disc 3 and/or 5 not closed	Manually operate cam gear to flush out foreign matter holding disc open. Replace if needed
	Air check valve prematurely closed	Briefly put control into brine refill status. Refer to the “Manual Regeneration” section. Repair air check valve if needed
<ul style="list-style-type: none"> <li>Brine tank overflow</li> </ul>	Brine valve disc 1 held open	Manually operate cam gear to flush out foreign matter holding disc open
	Valve disc 2 not closed during brine draw, causing brine refill	Manually operate cam gear to flush out foreign matter holding disc open
	Air leak in brine line to air check	Check all connections in brine line for leaks
	Salt setting too high	Set in new values—refer to programming section
<ul style="list-style-type: none"> <li>Intermittent or irregular brine draw</li> </ul>	Low water pressure	Increase water pressure (20 psi at conditioner)
	Defective injector	Replace both injector and injector cap
<ul style="list-style-type: none"> <li>No conditioned water after regeneration</li> </ul>	Unit did not regenerate	Check for power
	No salt in brine tank	Add salt to brine tank
	Plugged injector	Remove injector and flush it and injector screen
	Air check valve closed prematurely	Put control momentarily into REFILL to free air check—replace or repair air check as needed
	Incorrect salt type or use of grid plate (salt shelf) in brine tank	Do not use block salt or grid plate (salt shelf) in brine tank

**Table 10:(Continued)** Troubleshooting procedures for most common

<b>Problem Description</b>	<b>Possible Cause</b>	<b>Solution</b>
<ul style="list-style-type: none"> <li>Control backwashes at excessively low or high rate</li> </ul>	Incorrect backwash controller	Replace with correct size controller
	Foreign matter affecting controller operation	Remove and clean controller
<ul style="list-style-type: none"> <li>Flowing or dripping water at drain line or brine line after regeneration</li> </ul>	Drain valve (2 or 6) or brine valve (1) held open by foreign matter	Manually operate cam gear to flush out foreign matter holding disc open
	Weak valve stem return spring on top plate	Replace spring
	Resin in valve	Clean valve and backwash control
<ul style="list-style-type: none"> <li>Hard water leakage during service</li> </ul>	Improper regeneration	Repeat regeneration making sure the correct salt dosage is used
	Leaking bypass valve	Replace O-ring
	O-ring around riser tube damaged	Replace O-ring
	Incorrect salt type or use of grid plate (salt shelf) in brine tank	Do not use block salt or grid plate (salt shelf) in brine tank

**Table 10:(Continued)** Troubleshooting procedures for most common problems.











# Hamilton Beach®

© 2005 R&M Water Group. Water Technologies, Inc.. and R&M Water Group are branded trademarks of Water Technologies, Inc. All rights reserved.

Material produced by Water Technologies, Inc. and authorized by Hamilton Beach.

VERSION: 25 May 2005 | PN: L-R-HAMILTONBEACH-OM-CERT



## Free Manuals Download Website

<http://myh66.com>

<http://usermanuals.us>

<http://www.somanuals.com>

<http://www.4manuals.cc>

<http://www.manual-lib.com>

<http://www.404manual.com>

<http://www.luxmanual.com>

<http://aubethermostatmanual.com>

Golf course search by state

<http://golfingnear.com>

Email search by domain

<http://emailbydomain.com>

Auto manuals search

<http://auto.somanuals.com>

TV manuals search

<http://tv.somanuals.com>