

# SB 15/230

Active Speaker Soundbar

User Guide  
English



**harman/kardon®**  
Designed to Entertain.™



# SB 15/230 Soundbar Home Theater Speaker System Owner's Manual

## Table of Contents

Introduction .....	3
Description and Features .....	3
Included .....	4
Soundbar Top-Panel Controls.....	4
Soundbar Rear-Panel Controls and Connections .....	4
Subwoofer Rear-Panel Controls .....	5
Speaker Placement .....	6
Placing the Soundbar on a Table.....	6
Wall-Mounting the Soundbar.....	6
Placing the Subwoofer.....	6
Connections.....	7
Source Connections.....	7
Power Connections.....	7
Operation.....	8
Turning the Soundbar On and Off.....	8
Turning the Subwoofer On and Off.....	8
Adjusting the System's Volume.....	8
Muting the System.....	8
Soundbar Surround Mode Button.....	8
Subwoofer Volume Knob.....	9
Soundbar Trim Switch.....	9
Wireless Code Switches.....	9
Subwoofer Crossover Knob.....	9
Subwoofer Phase Switch.....	9
Programming the Soundbar to Respond to Your TV Remote .....	10
Troubleshooting.....	11
Specifications .....	12

## Important Safety Instructions

1. Read these instructions.
2. Keep these instructions.
3. Heed all warnings.
4. Follow all instructions.
5. Do not use this apparatus near water.
6. Clean only with a dry cloth.
7. Do not block any ventilation openings. Install in accordance with the manufacturer's instructions.
8. Do not install near any heat sources such as radiators, heat registers, stoves or other apparatus (including amplifiers) that produce heat.
9. Do not defeat the safety purpose of the polarized or grounding-type plug. A polarized plug has two blades with one wider than the other. A grounding-type plug has two blades and a third grounding prong. The wide blade or the third prong is provided for your safety. If the provided plug does not fit into your outlet, consult an electrician for replacement of the obsolete outlet.
10. Protect the power cord from being walked on or pinched, particularly at plugs, convenience receptacles and the point where they exit from the apparatus.
11. Only use attachments/accessories specified by the manufacturer.
12. Use only with the cart, stand, tripod, bracket or table specified by the manufacturer or sold with the apparatus. When a cart is used, use caution when moving the cart/apparatus combination to avoid injury from tip-over. 
13. Unplug this apparatus during lightning storms or when unused for long periods of time.
14. Refer all servicing to qualified service personnel. Servicing is required when the apparatus has been damaged in any way, such as power supply cord or plug is damaged, liquid has been spilled or objects have fallen into the apparatus, the apparatus has been exposed to rain or moisture, does not operate normally, or has been dropped.
15. Do not expose this apparatus to dripping or splashing and ensure that no objects filled with liquids, such as vases, are placed on the apparatus.
16. To completely disconnect this apparatus from the AC Mains, disconnect the power supply cord plug from the AC receptacle.
17. The mains plug of the power supply cord shall remain readily operable.
18. Do not expose batteries to excessive heat such as sunshine, fire or the like.

	<b>CAUTION</b>	
<small>THE LIGHTNING FLASH WITH AN ARROWHEAD SYMBOL WITHIN AN EQUILATERAL TRIANGLE, IS INTENDED TO ALERT THE USER TO THE PRESENCE OF UNINSULATED "DANGEROUS VOLTAGE" WITHIN THE PRODUCT'S ENCLOSURE THAT MAY BE OF SUFFICIENT MAGNITUDE TO CONSTITUTE A RISK OF ELECTRIC SHOCK TO PERSONS.</small>	<small>RISK OF ELECTRIC SHOCK DO NOT OPEN</small>	<small>THE EXCLAMATION POINT WITHIN AN EQUILATERAL TRIANGLE IS INTENDED TO ALERT THE USER TO THE PRESENCE OF IMPORTANT OPERATING AND MAINTENANCE (SERVICING) INSTRUCTIONS IN THE LITERATURE ACCOMPANYING THE PRODUCT.</small>
<small>SEE MARKING ON BACK OF PRODUCT.</small>		

# Harman Kardon® SB 15/230

## Introduction

Thank you for purchasing the Harman Kardon® SB 15/230 speaker system, with which you're about to begin many years of listening enjoyment. The SB 15/230 has been custom-designed to provide the excitement and power of the cinema experience in your own living room.

While sophisticated electronics and state-of-the-art speaker components are hard at work within the SB 15/230, hookup and operation are simple.

To obtain maximum enjoyment from your new soundbar speaker system, we urge you to take a few minutes to read through this manual. This will help ensure that the connections you make are correct. In addition, a few minutes spent learning the functions of the various controls will enable you to take advantage of all the power and refinement the SB 15/230 is able to deliver.

If you have any questions about this product, its installation or its operation, please contact your dealer, the best local source of information.

## Description and Features

The SB 15/230 is a complete home theater speaker system that includes:

- A video-shielded stereo soundbar speaker (the SB 15CNTR) with two-way dual-driver left and right speakers and built-in 25-watt x 2 stereo amplifier
- A 10-inch (250mm), 100-watt wireless powered subwoofer (the SB15SUB)
- Wall-mount brackets for the soundbar
- A 6.5-foot (2m) stereo audio cable for connecting the system directly to your TV's audio output.

The SB 15CNTR soundbar contains the system's left and right speakers and stereo amplifiers, and features digital signal processing with virtual 3D surround circuitry that creates a complete surround-sound experience without any extra speakers or wires. You can set the soundbar on a table in front of your TV, and the system includes hardware that makes it easy to mount the soundbar on the wall along with your flat-panel TV. You can program the soundbar to respond to your TV remote's volume, power and source commands.

The SB15SUB subwoofer receives its signal from the SB 15CTR soundbar via wireless technology, so you can place it anywhere in your room without having to run any wires. Its 10-inch (250mm) woofer and built-in 100-watt amplifier deliver a movie's impact and excitement. Other conveniences include a volume control, a phase switch for fine-tuning bass response to suit your listening environment, and an efficient switching system that senses the presence of an audio signal and automatically switches the subwoofer on.

Harman Kardon invented the high-fidelity receiver more than 50 years ago. With state-of-the-art features and time-honored circuit designs, the SB 15/230 will turn your flat-screen TV into a fun and exciting home theater.

## Included

One SB 15CNTR soundbar speaker

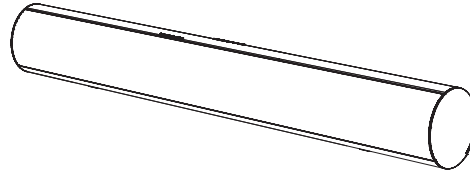

One SB 15SUB 10-inch (250mm) 100-watt wireless subwoofer

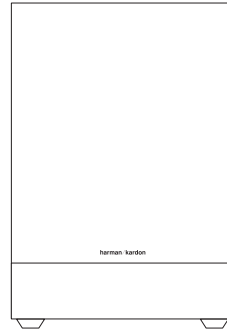

Two wall-mount brackets for the SB 15CNTR soundbar

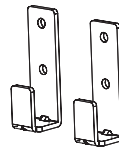

One 24V DC power supply and AC power cord for the SB 15CNTR speaker

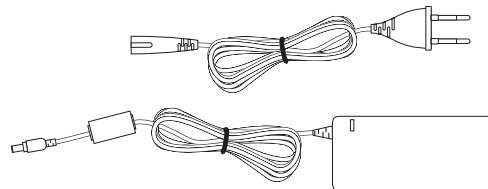

One 6.5-foot (2m) stereo audio cable

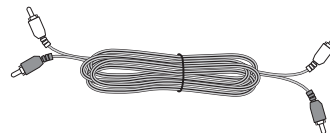

### Important

If anything is missing, or if any part of your SB 15/230 system fails to operate properly, contact your dealer immediately.

## Soundbar Top-Panel Controls

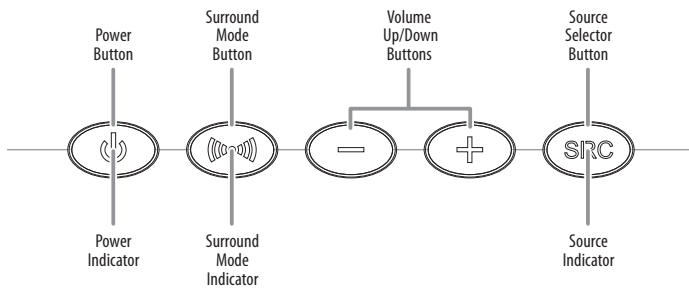

**Power Button:** When the soundbar is in the Standby mode (the Power Indicator is amber), press this button to turn the SB 15/230 system On. (The Power Indicator turns blue.) NOTE: When the soundbar is in the Standby mode, it will automatically turn On whenever it detects an audio signal at the Source 1 (analog) inputs.

When the SB 15/230 system is On:

- Momentarily press the Power button to mute the SB 15/230 system. (The Power Indicator flashes blue.)
- Hold down the Power button for three seconds to put the soundbar in the Standby mode. (The Power Indicator turns amber.) NOTE: The subwoofer will remain on for approximately 15 minutes after the audio signal ceases, then will automatically go into the Standby mode.

**Surround Mode Button:** This button turns the SB 15/230 system's 3D Surround processing On and Off. The **Surround Mode Indicator** turns blue when 3D Surround is active, and turns white when 3D Surround is not active (normal stereo sound). See *Soundbar Surround Mode Button*, on page 8, for more information.

**Volume Up/Down Buttons:** Press the (–) button to reduce the volume; press the (+) button to increase the volume.

**Source Selector Button:** This button switches between the sources connected to the Source 1 (analog) and Source 2 (digital) inputs. When Source 1 is active, the **Source Indicator** turns white; when Source 2 is active, the Source Indicator turns blue.

## Soundbar Rear-Panel Controls and Connections

**Wireless Code Switch:** Selects between four different channels for the wireless subwoofer signal.

**IMPORTANT:** Be sure to set the subwoofer's Wireless Code switch to the same channel that you set the soundbar's Wireless Code switch. See *Wireless Code Switches*, on page 9, for more information.

**EQ Switch:** This switch adjusts the soundbar's bass for either wall or table mounting. If you're mounting the soundbar on a wall with the included wall-mount brackets, set this switch to the *Wall* position for the most natural-sounding bass performance. If you are placing the soundbar on a table, set the EQ switch to the *Table* position for the most natural-sounding bass performance.

**Trim Switch:** This switch adjusts the soundbar's input sensitivity so it will work with TVs that have different audio signal output levels. See *Soundbar Trim Switch*, on page 9, for more information.

**Source 1 Connection (analog):** Use the included stereo audio cable to connect the stereo analog outputs of your TV, DVD player or cable/satellite tuner here.

**Source 2 Connection (digital):** If your TV, DVD player or cable/satellite tuner has a coaxial digital output, you can connect it here.

NOTE: If you connect your TV or another component to the soundbar's Source 1 connection, you can connect a different component to the Source 2 connection.

**Power Connection:** Connect the included DC power supply here. See *Power Connections*, on page 7, for more information.

**IMPORTANT:** Do not connect the power supply's AC cord to an AC outlet until you have made and verified all connections.

**Power Switch:** Set this switch to the On position (press the switch's white dot) to activate the soundbar. In normal operation, this switch will be left in the On position. See *Turning the Soundbar On and Off*, on page 8, for more information.

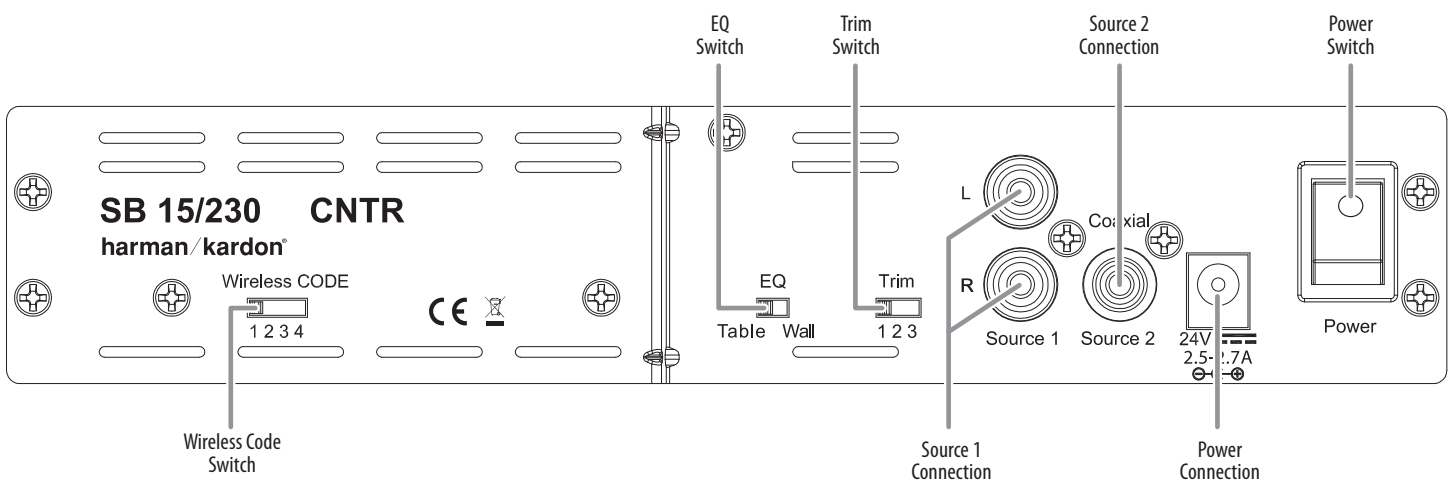

# Subwoofer Rear-Panel Controls

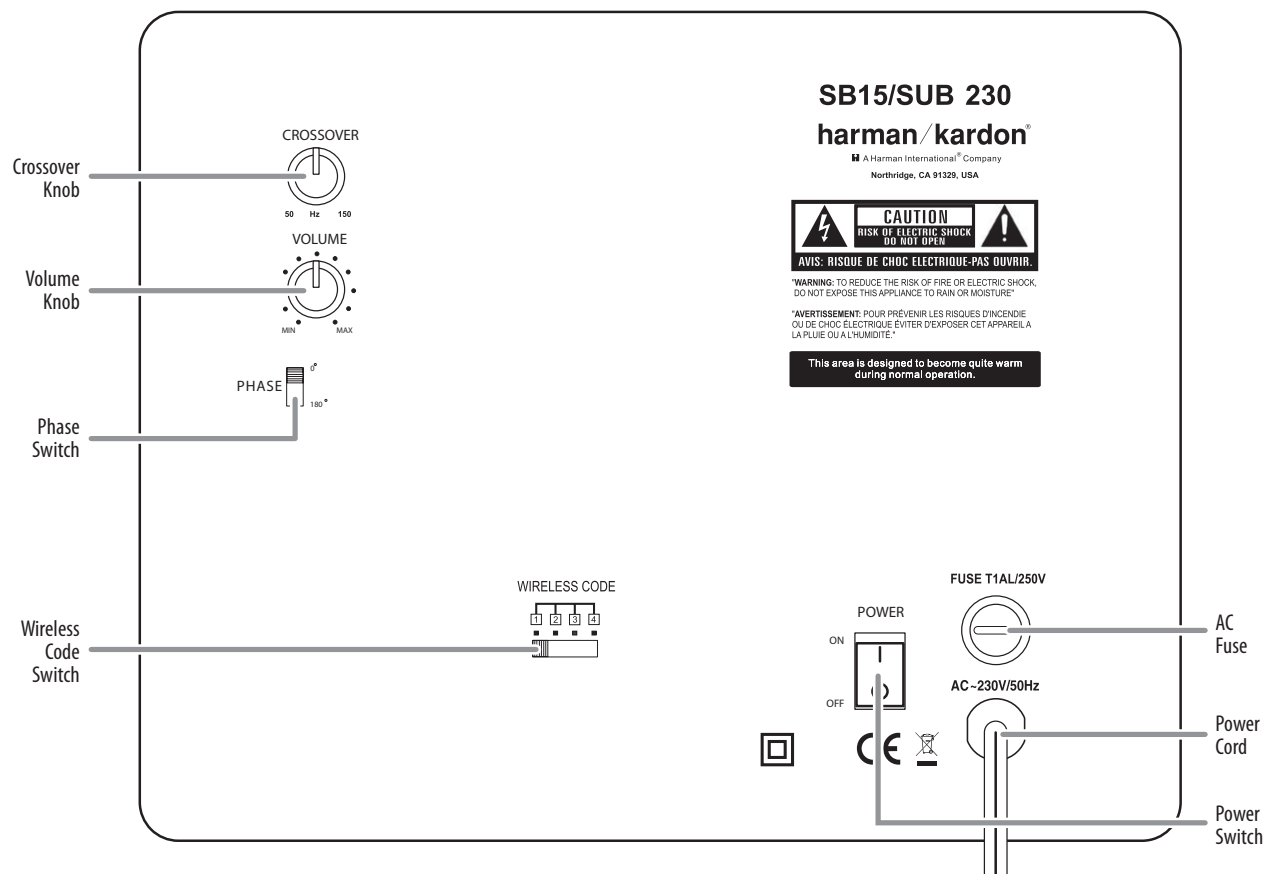

**Crossover Knob:** This knob adjusts the subwoofer's crossover between 50Hz and 150Hz. The higher you set the Crossover knob, the higher in frequency the subwoofer will operate and the more its bass will "overlap" that of the soundbar. This adjustment helps achieve a smooth transition of bass frequencies between the subwoofer and the soundbar for a variety of different rooms and subwoofer locations. See *Subwoofer Crossover Knob*, on page 9, for more information.

**Volume Control:** Use this control to balance the subwoofer's volume with that of the soundbar. Turn the knob clockwise to increase the subwoofer's volume; turn it counterclockwise to decrease the subwoofer's volume.

**Phase Switch:** This switch determines whether the subwoofer driver's piston-like action moves in and out in phase with the speakers in the soundbar. If the subwoofer were to play out of phase with the soundbar speakers, some of the sound waves produced by the subwoofer or soundbar could be canceled, reducing bass performance and sonic impact. This phenomenon depends in part on the relative placement of the speakers in the room. See *Subwoofer Phase Switch*, on page 9, for more information.

**Wireless Code Switch:** Selects between four different channels for the wireless subwoofer signal. **IMPORTANT:** Be sure to set the soundbar's Wireless Code switch to the same channel as you set the subwoofer's Wireless Code switch. See *Wireless Code Switches*, on page 9, for more information.

**AC Fuse:** The SB 15SUB is factory-equipped with a T1A1/250V 1A – 250V AC fuse. If the fuse ever blows:

1. Unplug the power cord from the wall.
2. Use a screwdriver to remove the blown fuse.
3. Replace the fuse with an identical T1A1/250V 1A – 250V AC fuse.

**CAUTION:** FOR CONTINUED PROTECTION AGAINST FIRE, REPLACE THE FUSE ONLY WITH THE SAME TYPE AND RATING.

**Power Cord:** Plug this cord into an active, unswitched AC outlet. See *Power Connections*, on page 7, for more information.

**Power Switch:** Set this switch to the On position to activate the subwoofer. In normal operation, this switch will be left in the On position. See *Turning the Subwoofer On and Off*, on page 8, for more information.

**Status Indicator (on top of unit, not shown):** Lights blue when the subwoofer's power switch is in the On position; lights amber when the subwoofer is in Standby; turns off when the subwoofer's Power switch is in the Off position.

# Speaker Placement

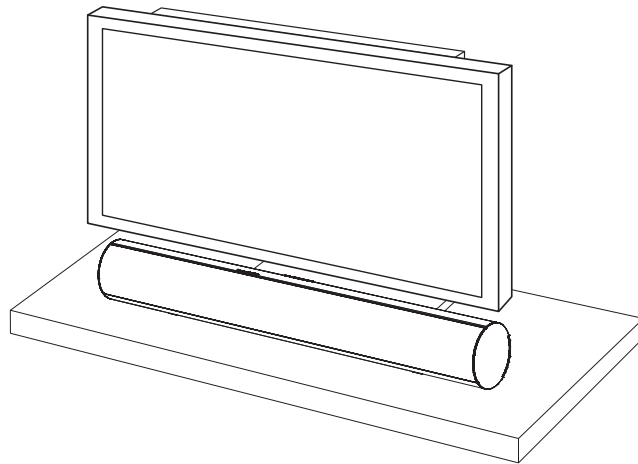

## Placing the Soundbar on a Table

If your TV is placed on a table, you can place the soundbar on the table directly in front of the TV stand, centered with the TV screen. As long as the surface of the table is flat, the soundbar will rest on its rubber bumpers.

## Wall-Mounting the Soundbar

If your TV is attached to a wall, you can use the included wall-mount brackets to mount the soundbar on the wall directly below the TV screen.

1. Determine the location for the soundbar on the wall. Make sure that the top of the soundbar will not block your view of the TV screen when it is mounted on the wall.
2. Mark the locations of the soundbar wall-mount bracket holes on the wall. The holes for the left and right brackets are spaced 600mm apart, and are designed to accept #8 screws. The top and bottom holes for each bracket are spaced 25mm apart. See the illustration below.

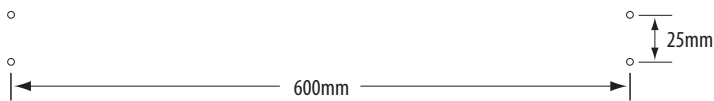

**NOTE:** To ensure that the soundbar will be level, use a carpenter's level, laser sight or other device to ensure that the two sets of holes are at exactly the same height.

3. Attach the two wall-mount brackets to the wall at the locations you marked, using hardware that is appropriate for the wall's construction and materials. Note that the soundbar weighs 3.6kg (8 lb). Be sure to use hardware that can support this weight.

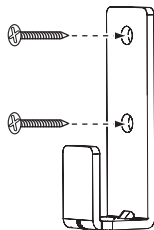

4. After making all of the connections described in the Connections section, on page 7, attach the soundbar to the brackets by sliding the slots in its rubber bumpers onto the brackets' vertical tabs.

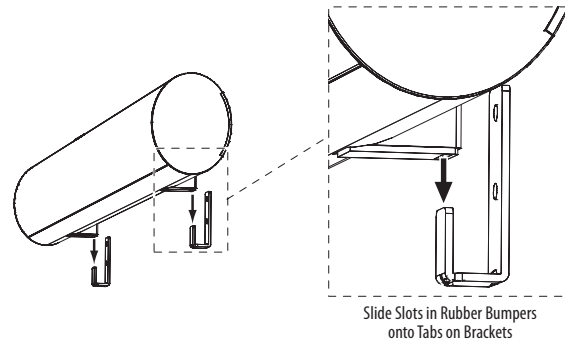

## Placing the Subwoofer

Since our ears do not hear directional sound at the low frequencies where the subwoofer operates, it will have good performance from just about any location in your room. However, the strongest bass reproduction is likely to be heard when the subwoofer is placed in a corner along the same wall as the soundbar.

**IMPORTANT:** Make sure that the subwoofer's rear panel is at least 150mm (6") from the wall, to allow proper operation of its port tube opening.

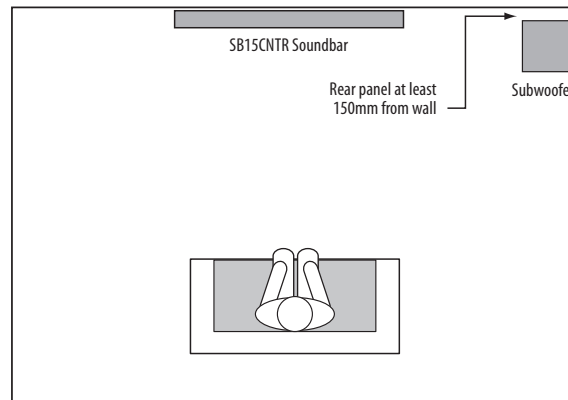

You can experiment with subwoofer placement by temporarily placing it in the listening position and playing music with strong bass content. Move around to various locations in the room while the system is playing and listen until you find the location where the bass performance is best. Place the subwoofer in that location.

**IMPORTANT:** The maximum wireless operating distance between the soundbar and subwoofer is approximately 15.3m (50 feet).

# Connections

## Source Connections

**Analog:** Use the supplied stereo audio cable to connect the soundbar's Source 1 (analog) input to your TV's stereo audio output. If your TV has two sets of audio output jacks, use the set that has a fixed (not variable) output level. This will let you turn your TV's speakers all the way off while the TV still supplies a constant audio signal to the soundbar.

**Digital:** If your DVD player, cable tuner or satellite tuner has a coaxial digital output, you can use a coaxial digital audio cable (not supplied) to connect it to the soundbar's Source 2 (digital) input.

**NOTE:** If your DVD player, cable tuner or satellite tuner does not have a coaxial digital output, you can connect its analog audio output to your TV. The TV will send its audio signal to the soundbar through the analog connection described above.

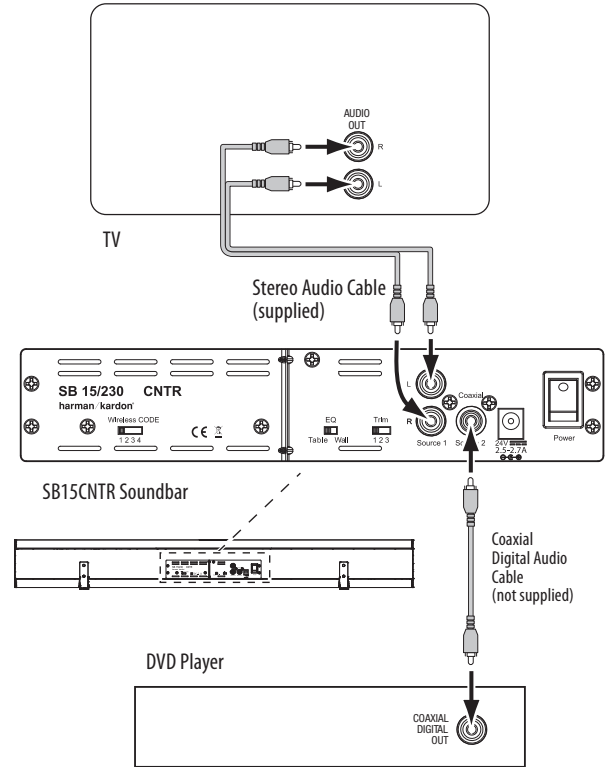

## Power Connections

After you have made and verified all of the source connections above:

1. Connect the DC power supply to the soundbar's power connection. Then plug the supplied AC cord into the DC power supply and into an active, unswitched AC outlet. DO NOT plug this cord into the accessory outlets found on some audio components.
2. Plug the subwoofer's power cord into an active, unswitched AC outlet. DO NOT plug this cord into the accessory outlets found on some audio components.

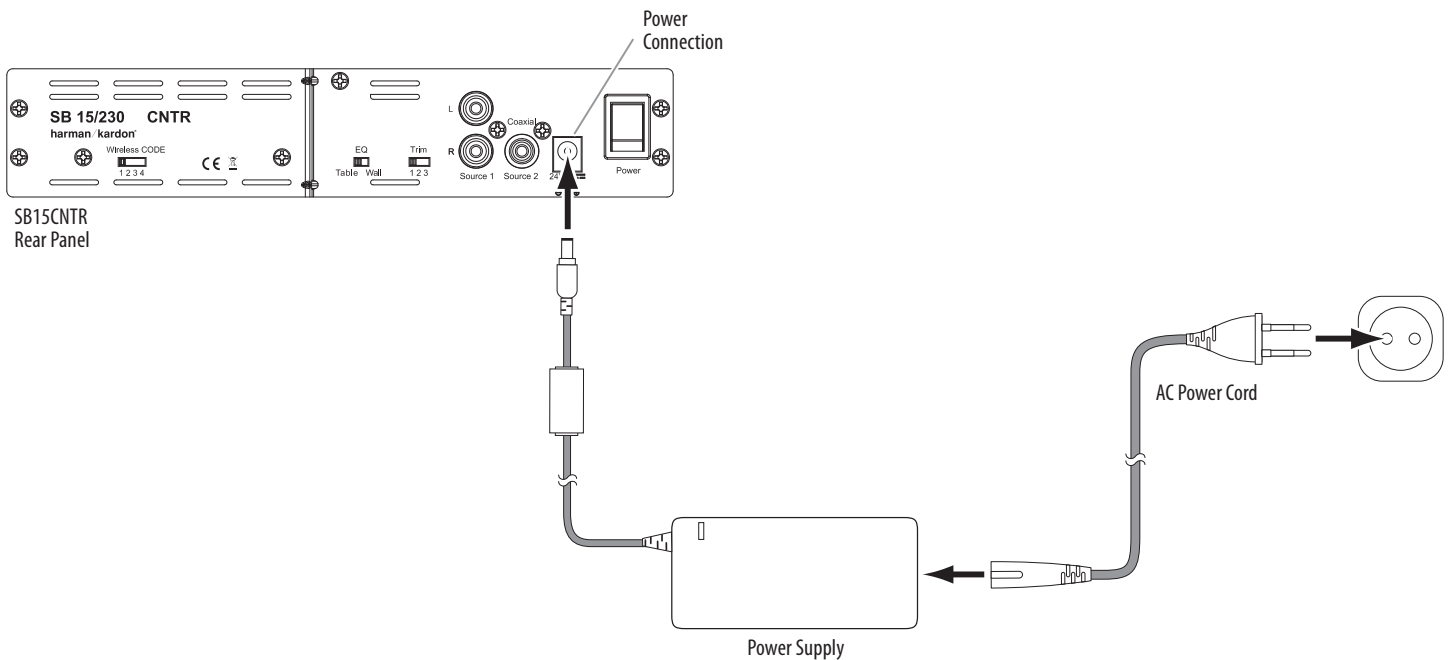

# Operation

## Turning the Soundbar On and Off

Set the soundbar's Power switch to On (press the switch's white dot).

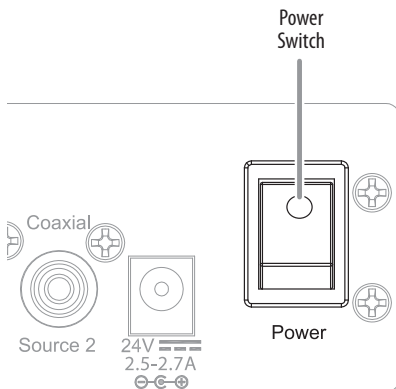

**To turn the soundbar On automatically:** The soundbar will automatically turn itself on when it receives an audio signal at the Source 1 (analog) inputs.

**To turn the soundbar On manually:** Momentarily press the soundbar's Power button to turn the soundbar On.

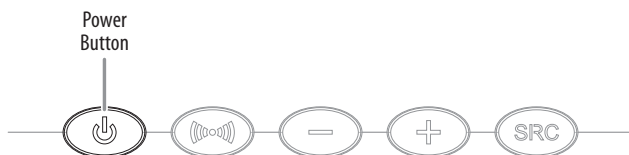

**To put the soundbar into Standby:** Hold down the soundbar's Power button for at least three seconds.

If you will be away from home for an extended period of time, or if you will not be using the system for an extended period, set the soundbar's Power switch to Off.

## Turning the Subwoofer On and Off

Set the subwoofer's Power switch to the *On* position. This will put the subwoofer into the Standby mode. The subwoofer will automatically turn itself On when it receives an audio signal, and it will return to the Standby mode when it has received no audio signal for 15 minutes. The subwoofer's LED will illuminate *blue* when the subwoofer is On, and will be illuminated *amber* when the subwoofer is in Standby.

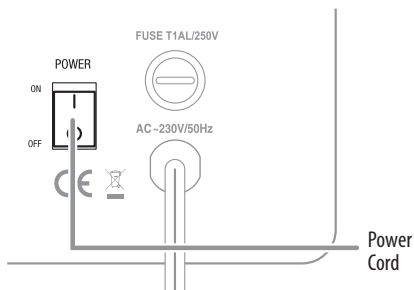

If you will be away from home for an extended period of time, or if you will not be using the system for an extended period, set the subwoofer's Power switch to the Off position.

## Adjusting the System's Volume

Press the soundbar's Volume Up and Down buttons to raise and lower the system's volume one step at a time. Hold down the buttons to continuously raise or lower the volume. NOTE: The lowest setting of the Volume Down button will mute the system.

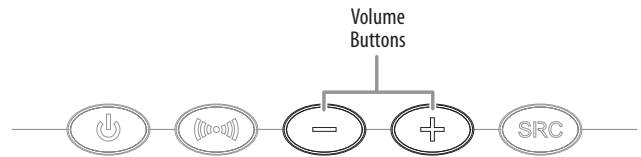

If the system will not play loud enough or quiet enough, adjust the Trim Switch (see *Soundbar Trim Switch*, on page 9).

For the best sound, we recommend turning your TV's built-in speakers off. Consult your TV's owner's manual to find out how to do this. If there is no way to turn your TV's speakers off, you can adjust the TV's volume so that your SB 15/230 system will always supply most of the sound:

1. Using the volume buttons on your TV, turn its volume all the way down.
2. Then, use the soundbar's Volume Up/Down buttons to set the sound to a comfortable listening level.

This way your SB 15/230 system should always be louder than your TV's speakers. NOTE: This may reduce the volume of your TV's output connection, so you may have to set the soundbar's Trim Switch to position 3 to compensate. See *Soundbar Trim Switch*, on page 9.

## Muting the System

Momentarily press the soundbar's Power button to mute the system. (The Power Indicator flashes blue.) Momentarily press the Power button again to un-mute the system. (The Power Indicator turns to a steady blue.)

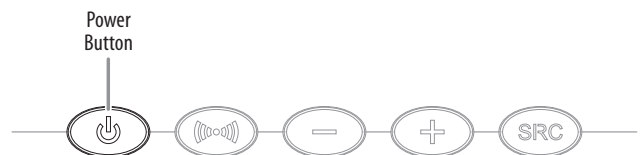

## Soundbar Surround Mode Button

This button switches the sound between normal stereo (the Surround Mode Indicator lights *white*) and 3D Surround (the Surround Mode Indicator lights *blue*). The 3D Surround setting will produce a complete surround-sound experience for anyone sitting in front of and several feet away from the soundbar. Although it is particularly effective when watching movies, you can also try the 3D Surround setting for music.

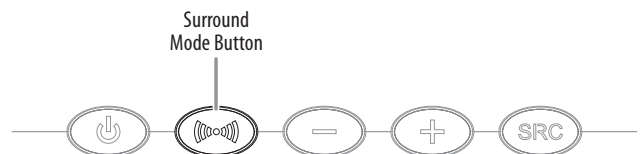



## Subwoofer Volume Knob

Use the subwoofer's Volume knob to balance the bass with the rest of the sound. Play music or movies that you are familiar with and adjust the subwoofer's Volume knob so the bass sounds balanced on both music and films. Listen to several different music recordings and film soundtracks that contain strong bass passages and find a setting for the Volume knob that doesn't over-emphasize the bass or make it sound weak.

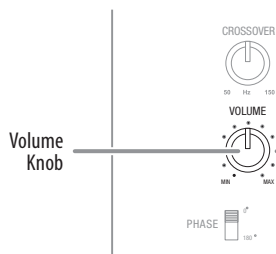

Once you find a setting for the subwoofer's Volume knob that balances the bass with the rest of the sound, you shouldn't have to change it.

## Soundbar Trim Switch

This switch adjusts the soundbar's audio input sensitivity so it will work with TVs that have different audio signal output levels. If your TV's audio signal output is low, the soundbar may not play loud enough. In this case, set the Trim switch to position 3 so the soundbar will play louder. If your TV's audio signal output is high, you may hear distortion in the soundbar at normal listening volumes. In this case, set the Trim Switch to position 1 to reduce the distortion and improve the sound.

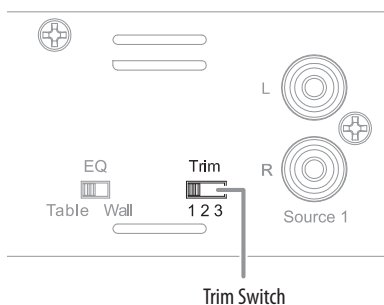

## Wireless Code Switches

In the unlikely event that there is interference when operating the system, or if you have more than one SB 15/230 system in operation, you may change the wireless channel at which the system operates. There are four-position Wireless Code switches on both the soundbar and subwoofer. To change the wireless channel, simply set each of the switches to one of the other three positions. **IMPORTANT:** The switches on the soundbar and the subwoofer must be set to the *same* position for the wireless system to work properly.

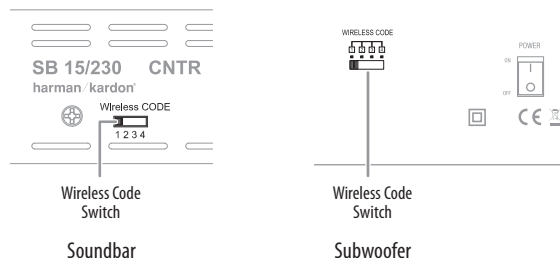

**NOTE:** The maximum wireless operating distance between the soundbar and subwoofer is approximately 50 feet (15.3m).

## Subwoofer Crossover Knob

The subwoofer's Crossover knob adjusts the subwoofer's crossover between 50Hz and 150Hz. The higher you set the Crossover knob, the higher in frequency the subwoofer will operate and the more its bass will "overlap" that of the soundbar. This adjustment helps achieve a smooth transition of bass frequencies between the subwoofer and the soundbar for a variety of different rooms and subwoofer locations.

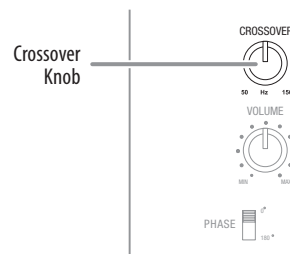

To set the Crossover knob, listen for the smoothness of the bass. If the bass seems too strong at certain frequencies, try a lower Crossover knob setting. If the bass seems too weak at certain frequencies, try a higher Crossover knob setting.

## Subwoofer Phase Switch

This switch determines whether the subwoofer's piston-like action moves in and out in phase with the speakers in the soundbar. If the subwoofer were to play out of phase with the soundbar speakers, some of the sound waves produced by the soundbar and subwoofer could be canceled out at some frequencies, reducing bass performance and sonic impact. This phenomenon depends in part on the relative placement of all the speakers in the room.

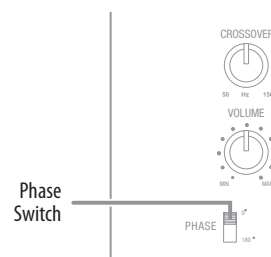

Although there is no absolute correct setting for the Phase switch, in most cases it should be left in the 0° position. When the subwoofer is properly in phase with the soundbar speakers, the sound will be clearer and have more impact. This will make percussive sounds like drums, piano and plucked strings sound more lifelike. The best way to set the Phase switch is to listen to music that you are familiar with and adjust the switch so that drums and other percussive sounds have maximum impact.

# Programming the Soundbar to Respond to Your TV Remote

You can program the soundbar so it will respond to your TV remote's Power, Mute, Volume Up, Volume Down and Source commands. This lets you control your whole home theater system with a single remote. Before beginning to program the soundbar, have your TV remote handy. We recommend sitting down in front of the soundbar. The steps will time-out, so read through the entire procedure before you begin.

## To program the power command:

1. With the soundbar turned on, hold down the soundbar's Power and Source Selector (SRC) buttons together until all the soundbar button indicators flash. This enters the learning mode.

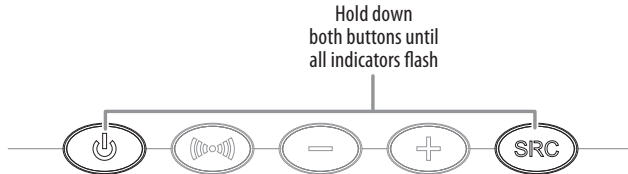

2. Momentarily press the soundbar's Power button. It will turn amber.

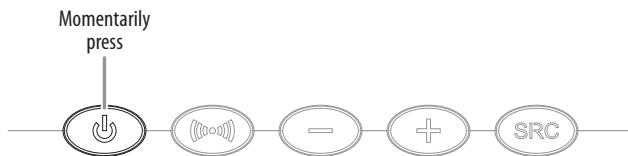

3. Aim the TV remote at the front of the soundbar from about 300mm-900mm (about 12-36 inches) away.

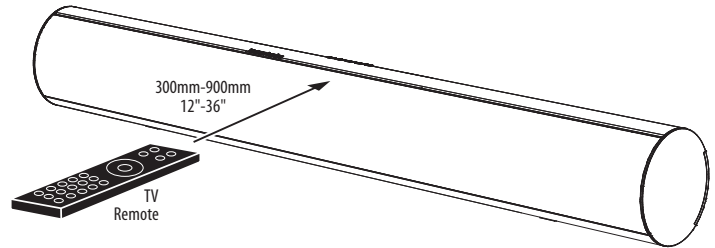

4. Hold down the TV remote's Power button for one second, then release it. Do this a total of four (4) times. When the soundbar has learned the power command, its Power Indicator will turn blue, and the Surround Mode and Source Selector Indicators will flash blue.

- If the Power Indicator flashes amber, the procedure failed. Repeat Steps 1 – 4.

## To program the source, volume + and volume – commands:

Follow Steps 1–4 as above, but in Steps 2 and 4, substitute the soundbar and TV remote's Source Selector and Volume Up/Down buttons for the Power buttons.

## To program the mute command:

Follow Steps 1-4 as above, but in Step 2, hold down the soundbar's Power button for 2-3 seconds. In step 4, substitute the TV remote's Mute button for its Power button.

## To erase all remote programming:

Hold down the soundbar's Surround Mode and Volume Up buttons at the same time for 2-3 seconds.

# Troubleshooting

## If the soundbar does not turn on:

- Check that the soundbar power supply's AC cord is plugged into a working AC outlet, and that the power supply is plugged into the soundbar.
- Check that the soundbar's Power switch is in the On position.

## If the subwoofer does not turn on:

- Check that the subwoofer's power cord is plugged into a working AC outlet.
- Check that the subwoofer's Power switch is in the On position.
- Check if the subwoofer's AC fuse has blown. See *Subwoofer Rear-Panel Controls: AC fuse*, on page 5, for instructions on checking and changing the fuse.

## If there is no sound coming from both the soundbar and the subwoofer:

- Check that the soundbar is on (the Power Indicator is illuminated blue).
- Check that the cable connecting the TV or other source component to the soundbar is properly connected at both ends.
- Check that the soundbar's Source Selector is set to the correct source (the Source Indicator illuminates white for Source 1 – analog, and illuminates blue for Source 2 – digital), and that the source is playing an audio signal.
- Check that the system is not muted (when the system is muted, the soundbar's Power Indicator flashes blue). Momentarily press the Power button to un-mute the system.
- Check that the soundbar's volume is not turned all the way down (the lowest setting of the Volume Down button will mute the system).

## If there is no sound coming from just the subwoofer:

- Check that the Subwoofer Volume Control is not turned all the way down (fully counterclockwise).
- Check that the Wireless Code switches on the subwoofer and soundbar are both set to the same setting number.
- Move the subwoofer closer to the soundbar. (The maximum wireless operation distance is 50 feet (15.3m).

## If the soundbar's sound is distorted:

- Set the soundbar's Trim switch to a lower setting.
- Check the source component to see if the distortion is coming from it, and not the soundbar.

## If the system's sound is too quiet, even when the soundbar's volume is turned all the way up:

- Set the soundbar's Trim switch to a higher setting.
- If the TV or source component is connected via a variable output, check its instructions to be sure that the output is not turned down too low.

## The bass output is not loud enough:

- Turn up the subwoofer's Volume knob.
- Move the subwoofer into a corner of the room.
- Move the subwoofer closer to the seating location.

## The soundbar won't learn your TV remote's commands:

- Carefully follow steps 1 – 4 of *Programming the Soundbar to Respond to Your TV Remote*, on page 9.
- Hold the TV remote 12 inches (300mm) in front of the soundbar during the learning procedure.
- Although the soundbar will learn commands from most TV remotes, there may be some IR codes that it cannot learn.

## If you press your TV remote's Power button and the soundbar turns off when the TV turns on (or vice versa):

- Press the Power button on either the soundbar or the TV (but not both) one time. This will put them back in sync so they will turn on and off together when you press the TV remote's Power button.

# Specifications

## SB 15/230 System

Frequency Response  
50Hz–20kHz

### SB 15CNTR Soundbar

Input Rating  
DC 24V, 2.5–2.7A

Amplifier Power  
25 watts x 2

Tweeter  
Two 3/4" domes (one per channel),  
video-shielded

Midrange  
Four 3" drivers (two per channel), video-  
shielded

Dimensions (H x W x D)  
110mm x 920mm x 89mm  
(4-5/16" x 36-1/4" x 3-1/2")

Weight  
8 lb (3.6kg)

### SB 15SUB Subwoofer

Input rating:  
AC 230V, 50Hz, 100W

Amplifier Power  
100 watts RMS

Woofers  
10" cone, vented enclosure

Dimensions (H x W x D)  
480mm x 380mm x 380mm  
(18-7/8" x 13-3/8" x 13-3/8")

Weight  
34 lb (15.4kg)

**H** Harman International

Harman Consumer Group, Inc.  
8500 Balboa Boulevard, Northridge, CA 91329 USA  
516.255.4545 (USA only)

[www.harmanardon.com](http://www.harmanardon.com)

Made in China

©2009 Harman International Industries, Incorporated. All rights reserved.

Features, specifications and appearance are subject to change without notice.

Harman Kardon is a trademark of Harman International Industries, Incorporated, registered in the United States and/or other countries. Designed to Entertain is a trademark of Harman International Industries, Incorporated.

Part No. 406-000-06124-E

## Free Manuals Download Website

<http://myh66.com>

<http://usermanuals.us>

<http://www.somanuals.com>

<http://www.4manuals.cc>

<http://www.manual-lib.com>

<http://www.404manual.com>

<http://www.luxmanual.com>

<http://aubethermostatmanual.com>

Golf course search by state

<http://golfingnear.com>

Email search by domain

<http://emailbydomain.com>

Auto manuals search

<http://auto.somanuals.com>

TV manuals search

<http://tv.somanuals.com>