

AVR 120 Audio/Video Receiver

OWNER'S MANUAL

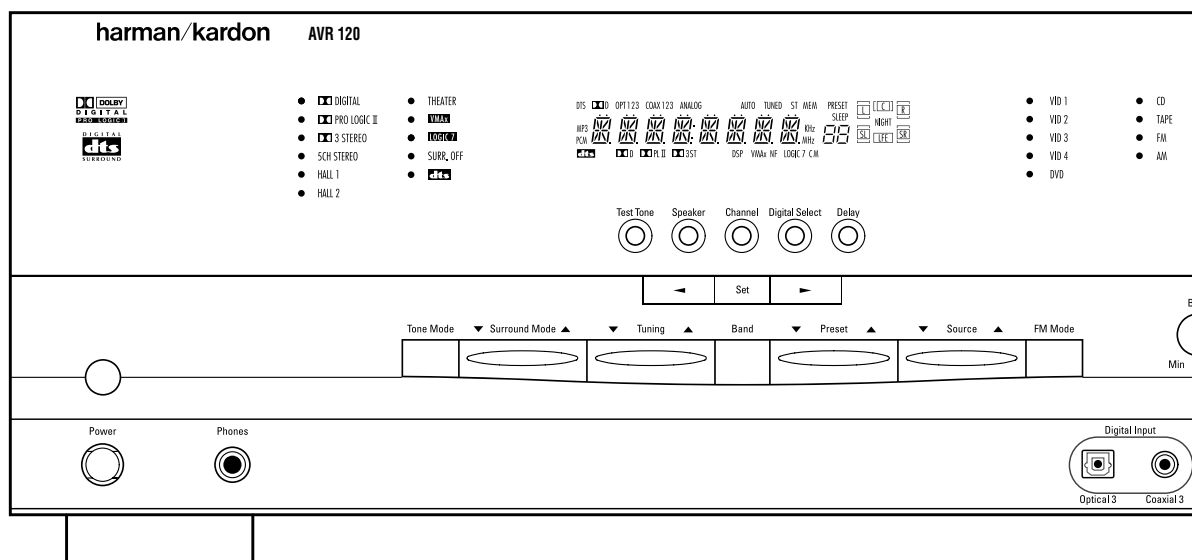

harman/kardon®

Power for the Digital Revolution.™

AVR 120 Audio/Video Receiver

3	Introduction
4	Safety Information
4	Unpacking
5	Front Panel Controls
7	Front Panel Information Display
9	Rear Panel Connections
11	Remote Control Functions
14	Installation and Connections
14	System Installation
14	Audio Equipment Connections
14	Video Equipment Connections
15	Power Connections
16	System Configuration
16	Speaker Selection and Placement
17	System Setup
17	Speaker Setup
18	Output Level Adjustment
19	Delay Settings
20	Additional Input Adjustments
21	Operation
21	Basic Operation
21	Source Selection
21	Volume Control
22	Surround Mode Chart
23	Surround Mode Selection
23	Digital Audio Playback
23	Selecting a Digital Source
24	Digital Status Indicators
24	Night Mode
25	MP3 Audio Playback
25	Tuner Operation
26	Tape Recording
26	Output Level Trim Adjustment
26	Display Brightness
27	Programming the Remote
27	Direct Code Entry
27	Auto Search Method
27	Code Readout
28	Macro Programming
28	Programmed Device Functions
29	Punch-Through Programming
29	Volume Punch-Through
29	Channel Control Punch-Through
30	Transport Control Punch-Through
30	Reassigning Device Control Selectors
30	Resetting the Remote Memory
31	Function List
33	Setup Code Tables
42	Troubleshooting Guide
42	Processor Reset
43	Technical Specifications

Typographical Conventions

In order to help you use this manual with the remote control, front panel controls and rear panel connections, certain conventions have been used.

EXAMPLE – (bold type) indicates a specific remote control or front panel button, or rear panel connection jack

EXAMPLE – (OCR type) indicates a message that is visible on the front panel information display

1 – (number in a square) indicates a specific front panel control

① – (number in a circle) indicates a rear panel connection

Ⓚ – (number in an oval) indicates a button or indicator on the remote

A – (letter in a square) indicates an indicator in the front panel display

Introduction

Thank you for choosing Harman Kardon!

With the purchase of a Harman Kardon AVR 120 you are about to begin many years of listening enjoyment. The AVR 120 has been custom-designed to provide all the excitement and detail of movie soundtracks and every nuance of musical selections. With onboard Dolby* Digital and DTS® decoding, the AVR 120 delivers six discrete channels of audio that take advantage of the digital soundtracks from the latest DVD and LD releases and Digital Television broadcasts.

While complex digital systems are hard at work within the AVR 120 to make all of this happen, hookup and operation are simple. Color-keyed connections and a programmable remote control make the AVR 120 easy to use. To obtain the maximum enjoyment from your new receiver, we urge you to take a few minutes to read through this manual. This will ensure that connections to speakers, source playback units and other external devices are made properly. In addition, a few minutes spent learning the functions of the various controls will enable you to take advantage of all the power the AVR 120 is able to deliver.

If you have any questions about this product, its installation or its operation, please contact your retailer or custom installer. They are your best local sources of information.

Description and Features

The AVR 120 is among the most versatile and multifeatured A/V receivers available, incorporating a wide range of listening options. In addition to Dolby Digital and DTS decoding for digital sources, a broad choice of analog surround modes are available for use with sources such as CD, VCR, TV broadcasts and the AVR 120's own FM/AM tuner. Along with the latest Dolby Pro Logic* II decoding technology, Dolby 3 Stereo and custom Hall and Theater modes, only Harman Kardon receivers offer Logic 7® to create a wider, more enveloping field environment and more defined fly-overs and pans. Another Harman Kardon exclusive is VMAx®, which uses proprietary processing to create an open, spacious sound field even when only two front speakers are available. Finally, the AVR 120 is among the very few A/V receivers that offer decoding of MP3 data, so that you may listen to the latest music selections directly from compatible computers or playback devices with the power and fidelity you expect from Harman Kardon.

In addition to providing a wide range of listening options, the AVR 120 is easy to configure so that it provides the best results with your speakers and specific listening-room environment.

For the ultimate in flexibility, the AVR 120 features connections for five video devices, all with both composite and S-Video inputs, including the front panel inputs. Two additional audio inputs are available, and a total of six digital inputs make the AVR 120 capable of handling all the latest digital audio sources. Coax and optical digital outputs are also available for direct connection to digital recorders. The AVR 120's powerful amplifier uses traditional Harman Kardon high-current design technologies to meet the wide dynamic range of any program selection.

Harman Kardon invented the high-fidelity receiver more than forty-seven years ago. With state-of-the-art circuitry and time-honored circuit designs, the AVR 120 is one of the finest receivers ever offered by Harman Kardon.

- **Onboard Dolby Digital and DTS Decoding Using Crystal® Chip Technology**
- **Harman Kardon's Exclusive Logic 7 and VMAx Modes**
- **Dolby Laboratories' Latest Pro Logic II Decoding Technology**
- **MP3 Decoding for Use With Computers and Digital Audio Players**
- **Front Panel Digital Inputs for Easy Connection to Portable Digital Devices and the Latest Video Game Consoles**
- **Multiple Digital Inputs and Outputs**
- **Color-Coded Input, Output and Speaker Terminals Comply With the Latest CEA Standards for Easy Installation**

CAUTION

**RISK OF ELECTRIC SHOCK
DO NOT OPEN**

CAUTION: To prevent electric shock, do not use this (polarized) plug with an extension cord, receptacle or other outlet unless the blades can be fully inserted to prevent blade exposure.



The lightning flash with arrowhead symbol, within an equilateral triangle, is intended to alert the user to the presence of uninsulated "dangerous voltage" within the product's enclosure that may be of sufficient magnitude to constitute a risk of electric shock to persons.



The exclamation point within an equilateral triangle is intended to alert the user to the presence of important operating and maintenance (servicing) instructions in the literature accompanying the appliance.

Safety Information

Important Safety Information

Verify Line Voltage Before Use

Your AVR 120 has been designed for use with 120-volt AC current. Connection to a line voltage other than that for which it is intended can create a safety and fire hazard and may damage the unit.

If you have any questions about the voltage requirements for your specific model, or about the line voltage in your area, contact your selling dealer before plugging the unit into a wall outlet.

Do Not Use Extension Cords

To avoid safety hazards, use only the power cord attached to your unit. We do not recommend that extension cords be used with this product. As with all electrical devices, do not run power cords under rugs or carpets or place heavy objects on them. Damaged power cords should be replaced immediately by an authorized service depot with a cord meeting factory specifications.

Handle the AC Power Cord Gently

When disconnecting the power cord from an AC outlet, always pull the plug, never pull the cord. If you do not intend to use the unit for any considerable length of time, disconnect the plug from the AC outlet.

Do Not Open the Cabinet

There are no user-serviceable components inside this product. Opening the cabinet may present a shock hazard, and any modification to the product will void your guarantee. If water or any metal object such as a paper clip, wire or a staple accidentally falls inside the unit, disconnect it from the AC power source immediately, and consult an authorized service station.

CATV or Antenna Grounding

If an outside antenna or cable system is connected to this product, be certain that it is grounded so as to provide some protection against voltage surges and static charges. Section 810 of the National Electrical Code, ANSI/NFPA No. 70-1984, provides information with respect to proper grounding of the mast and supporting structure, grounding of the lead-in wire to an antenna discharge unit, size of grounding conductors, location of antenna discharge unit, connection to grounding electrodes and requirements of the grounding electrode.

NOTE TO CATV SYSTEM INSTALLER: This reminder is provided to call the CATV (Cable TV) system installer's attention to article 820-40 of the NEC that provides guidelines for

proper grounding and, in particular, specifies that the cable ground shall be connected to the grounding system of the building, as close to the point of cable entry as possible.

Installation Location

- To ensure proper operation and to avoid the potential for safety hazards, place the unit on a firm and level surface. When placing the unit on a shelf, be certain that the shelf and any mounting hardware can support the weight of the product.
- Make certain that proper space is provided both above and below the unit for ventilation. If this product will be installed in a cabinet or other enclosed area, make certain that there is sufficient air movement within the cabinet. Under some circumstances a fan may be required.
- Do not place the unit directly on a carpeted surface.
- Avoid installation in extremely hot or cold locations, or an area that is exposed to direct sunlight or heating equipment.
- Avoid moist or humid locations.
- Do not obstruct the ventilation slots on the top of the unit, or place objects directly over them.

Cleaning

When the unit gets dirty, wipe it with a clean, soft, dry cloth. If necessary, wipe it with a soft cloth dampened with mild soapy water, then a fresh cloth with clean water. Wipe dry immediately with a dry cloth. NEVER use benzene, aerosol cleaners, thinner, alcohol or any other volatile cleaning agent. Do not use abrasive cleaners, as they may damage the finish of metal parts. Avoid spraying insecticide near the unit.

Moving the Unit

Before moving the unit, be certain to disconnect any interconnection cords with other components, and make certain that you disconnect the unit from the AC outlet.

Important Information for the User

This equipment has been tested and found to comply with the limits for a Class-B digital device, pursuant to Part 15 of the FCC Rules. The limits are designed to provide reasonable protection against harmful interference in a residential installation. This equipment generates, uses and can radiate radio-frequency energy and, if not installed and used in accordance with the instructions, may cause harmful interference to radio communication. However, there is no guarantee that harmful interference will

not occur in a particular installation. If this equipment does cause harmful interference to radio or television reception, which can be determined by turning the equipment off and on, the user is encouraged to try to correct the interference by one or more of the following measures:

- Reorient or relocate the receiving antenna.
- Increase the separation between the equipment and receiver.
- Connect the equipment into an outlet on a circuit different from that to which the receiver is connected.
- Consult the dealer or an experienced radio/TV technician for help.

This device complies with Part 15 of the FCC Rules. Operation is subject to the following two conditions: (1) this device may not cause harmful interference, and (2) this device must accept interference received, including interference that may cause undesired operation.

NOTE: Changes or modifications may cause this unit to fail to comply with Part 15 of the FCC Rules and may void the user's authority to operate the equipment.

Unpacking

The carton and shipping materials used to protect your new receiver during shipment were specially designed to cushion it from shock and vibration. We suggest that you save the carton and packing materials for use in shipping if you move, or should the unit ever need repair.

To minimize the size of the carton in storage, you may wish to flatten it. This is done by carefully slitting the tape seams on the bottom and collapsing the carton. Other cardboard inserts may be stored in the same manner. Packing materials that cannot be collapsed should be saved along with the carton in a plastic bag.

If you do not wish to save the packaging materials, please note that the carton and other sections of the shipping protection are recyclable. Please respect the environment and discard those materials at a local recycling center.

At this time you should remove the protective plastic film from the front-panel lens. Leaving the film in place may affect the performance of your remote control.

Front Panel Controls

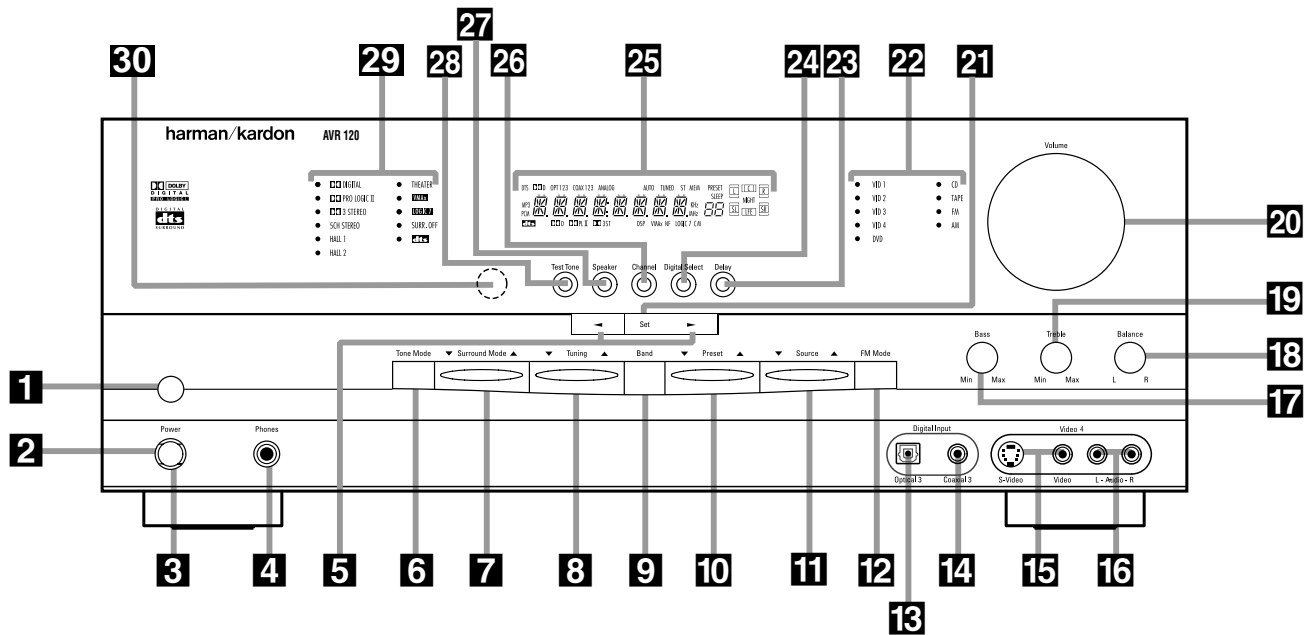

- 1** Main Power Switch
- 2** System Power Control
- 3** Power Indicator
- 4** Headphone Jack
- 5** Selector Buttons
- 6** Tone Mode
- 7** Surround Mode Selector
- 8** Tuning Selector
- 9** Tuner Band Selector
- 10** Preset Stations Selector
- 11** Input Source Selector
- 12** FM Mode Selector
- 13** Digital Optical 3 Input
- 14** Digital Coax 3 Input
- 15** Video 4 Video Input Jacks
- 16** Video 4 Audio Input Jacks
- 17** Bass Control
- 18** Balance Control
- 19** Treble Control
- 20** Volume Control
- 21** Set Button
- 22** Input Indicators
- 23** Delay
- 24** Digital Input Selector
- 25** Main Information Display
- 26** Channel Select Button
- 27** Speaker Select Button
- 28** Test Tone Selector
- 29** Surround Mode Indicators
- 30** Remote Sensor Window

1 Main Power Switch: Press this button to apply power to the AVR 120. When the switch is pressed in, the unit is placed in a Standby mode, as indicated by the amber LED **3** surrounding the **System Power Control 2**. This button **MUST** be pressed in to operate the unit. To turn the unit off and prevent the use of the remote control, this switch should be pressed until it pops out from the front panel so that the word "OFF" may be read at the top of the switch.

NOTE: This switch is normally left in the "ON" position.

2 System Power Control: When the **Main Power Switch 1** is "ON," press this button to turn on the AVR 120; press it again to turn the unit off. Note that the **Power Indicator 3** surrounding the switch will turn green when the unit is on.

3 Power Indicator: This LED will be illuminated in amber when the unit is in the Standby mode to signal that the unit is ready to be turned on. When the unit is in operation, the indicator will turn green. Should the indicator turn red, turn the unit off using the **Main Power Switch 1** and check the speaker wire connections to make certain that there are no short circuits.

4 Headphone Jack: This jack may be used to listen to the AVR 120's output through a pair of headphones. Be certain that the headphones have a standard 1/4" stereo phone plug. Note that the main room speakers will automatically be turned off when the headphone jack is in use.

5 Selector Buttons: When you are establishing the AVR 120's configuration settings, use these buttons to select from the choices available, as shown in the **Main Information Display 25**.

6 Tone Mode: Pressing this button enables or disables the Bass and Treble tone controls. When the button is pressed so that the words TONE IN appear in the **Main Information Display 25**, the settings of the **Bass 17** and **Treble 19** controls may be used to adjust the output signals. When the button is pressed so that the words TONE OUT appear in the **Main Information Display 25**, the output signal will be "flat," without any bass or treble alteration, no matter how the actual **Bass** and **Treble Controls 17/19** are adjusted.

7 Surround Mode Selector: Press this button to change the surround mode by scrolling through the list of available modes. Note that depending on the type of input, some modes are not always available. (See page 22 for more information about surround modes.)

Front Panel Controls

8 Tuning Selector: Press the left side of the button to tune lower-frequency stations and the right side of the button to tune higher-frequency stations. When a station with a strong signal is reached, the **TUNED Indicator** **Q** will be illuminated in the **Main Information Display** **25**.

To tune manually, tap the button lightly and note that the tuner will step up one frequency increment per button press. When the button is held for a few seconds you will note that the unit will quickly search the frequency band. Release it once the fast tuning starts; the tuner will automatically scan for the next station with an acceptable signal and then stop.

9 Tuner Band Selector: Pressing this button will automatically switch the AVR 120 to the Tuner mode. Pressing it again will switch between the AM and FM frequency bands. (See page 25 for more information on the tuner.)

10 Preset Stations Selector: Press this button to scroll up or down through the list or stations that have been entered into the preset memory. (See page 26 for more information on tuner presets.)

11 Input Source Selector: Press this button to change the input by scrolling up or down through the list of input sources.

12 FM Mode Selector: Press this button to select Auto or Manual tuning. When the button is pressed so that the **AUTO Indicator** **R** lights, the tuner will search for the next station with an acceptable signal when the **Tuning Selector** **8** **21** is pressed. When the button is pressed so that the **AUTO Indicator** **R** is not lit, each press of the **Tuning Selector** **8** **21** will increase the frequency. This button may also be used to switch between Stereo and Mono modes for FM radio reception. When weak reception is encountered, press the button until the **STEREO Indicator** **P** goes out to switch to Mono reception. Press and hold again to switch back to STEREO mode. (See page 25 for more information on using the tuner.)

13 Digital Optical 3 Input: Connect the optical digital output of an audio or video product to this jack. When the input is not in use, be certain to keep the plastic cap installed to avoid dust contamination that might degrade future performance.

14 Digital Coax 3 Input: This jack is used for connection to the output of portable audio devices, video game consoles or other products that have a coax digital jack.

15 Video 4 Video Input Jacks: These jacks may be used for temporary connection to the composite or S-Video output of video games, camcorders or other portable video products.

16 Video 4 Audio Input Jacks: These audio jacks may be used for temporary connection to video games or portable audio/video products such as camcorders and portable audio players.

17 Bass Control: Turn this control to modify the low-frequency output of the left/right channels by as much as $\pm 10\text{dB}$, when the unit is in the "Surround Off" mode. Set this control to a suitable position for your taste or room acoustics.

18 Balance Control: Turn this control to change the relative volume for the front left/right channels.

NOTE: For proper operation of the surround modes this control should be at the midpoint or "12 o'clock" position.

19 Treble Control: Turn this control to modify the high frequency output of the left/right channels by as much as $\pm 10\text{dB}$, when the unit is in the "Surround Off" mode. Set this control to a suitable position for your taste or room acoustics.

20 Volume Control: Turn this knob clockwise to increase the volume, counterclockwise to decrease the volume. If the AVR 120 is muted, adjusting the **Volume Control** **20** **63** will automatically release the unit from the silenced condition.

21 Set Button: When making choices during the setup and configuration process, press this button to enter the desired setting as shown in the **Main Information Display** **25** into the AVR 120's memory. The set button may also be used to change the display brightness. (See page 26.)

22 Input Indicators: A green LED will light in front of the input that is currently being used as the source for the AVR 120.

23 Delay: Press this button to begin the sequence of steps required to enter delay time settings. (See page 19 for more information on delay times.)

24 Digital Input Selector: When playing a source that has a digital output, press this button to select between the **Optical** **13** **23** and **Coaxial** **14** **24** **Digital** inputs. (See pages 23–25 for more information on digital audio.)

25 Main Information Display: This display delivers messages and status indications to help you operate the receiver. (See pages 7–8 for a complete explanation of the Information Display.)

26 Channel Select Button: Press this button to begin the process of trimming the channel output levels using an external audio source. (For more information on output level trim adjustment, see page 26.)

27 Speaker Select Button: Press this button to begin the process of configuring the unit to match the type of speakers used in your listening room. (See pages 16–19 for more information on speaker setup and configuration.)

28 Test Tone Selector: Press this button to begin the process of adjusting the channel output levels using the internal test tone as a reference. (For more information on output level adjustment, see page 18.)

29 Surround Mode Indicators: A green LED will light in front of the surround mode that is currently in use.

30 Remote Sensor Window: The sensor behind this window receives infrared signals from the remote control. Aim the remote at this area and do not block or cover it.

Front Panel Information Display

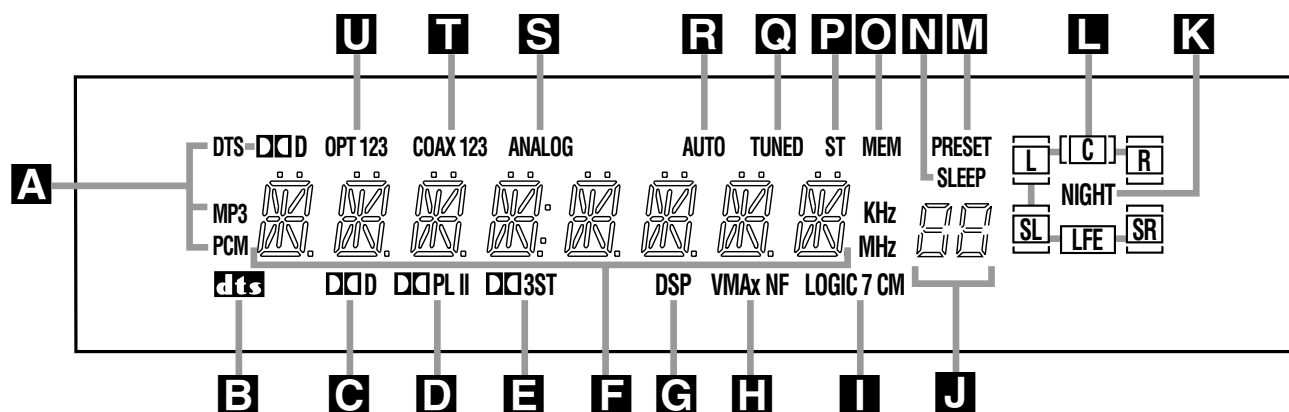

- A** Bitstream Indicators
- B** DTS Mode Indicator
- C** Dolby Digital Indicator
- D** Dolby Pro Logic II Indicator
- E** Dolby 3 Stereo Indicator
- F** Main Information Display
- G** DSP Mode Indicator
- H** VMAx Mode Indicators
- I** Logic 7 Mode Indicators
- J** Preset Number/Sleep Timer
- K** Night Mode Indicator
- L** Speaker/Channel Input Indicators
- M** Preset Indicator
- N** Sleep Indicator
- O** Memory Indicator
- P** Stereo Indicator
- Q** Tuned Indicator
- R** Auto Indicator
- S** Analog Input Indicator
- T** Coaxial Digital Input Indicators
- U** Optical Digital Input Indicators

A Bitstream Indicators: When the input is a digital source, one of these indicators will light to display the specific type of data signal in use.

B DTS Mode Indicator: This indicator lights when a DTS-encoded source is playing.

C Dolby Digital Indicator: This indicator lights when a Dolby Digital source is being played.

D Dolby Pro Logic II Indicator: This indicator lights when the Dolby Pro Logic II mode has been selected.

NOTE: It is possible to see the Dolby Pro Logic II indicator lit simultaneously with the Dolby Digital indicator, even though the Dolby Digital surround mode has been selected. This is due to the specifications for Dolby Digital processing, which require that the Dolby Pro Logic II mode apply any time a 2-channel Dolby signal is detected. If you desire 5.1-channel audio, check the audio settings in the menus for both your DVD player and your DVD disc to make sure that a 5.1-channel Dolby Digital sound track is available and has been selected.

E Dolby 3 Stereo Indicator: This indicator lights when the Dolby 3 Stereo mode has been selected.

F Main Information Display: This display shows messages relating to the status, input source, surround mode, tuner, volume level or other aspects of the AVR 120's operation.

G DSP Mode Indicator: This indicator lights when any of the surround modes created by Digital Signal Processing, or DSP are in use. These modes include Hall 1, Hall 2, Theater and 5-Channel Stereo.

H VMAx Mode Indicators: This indicator lights when the VMAx mode is in use. **VMAx F** appears when the Far Field VMAx mode is selected; **VMAx N** appears when the Near Field VMAx mode is selected. (See page 22 for a description of the VMAx modes.)

I Logic 7 Mode Indicators: These indicators light when the Logic 7 mode is in use. **LOGIC 7C** appears for the Cinema version of Logic 7; **LOGIC 7M** appears for the Music version of Logic 7. (See page 22 for a description of the Logic 7 modes.)

J Preset Number/Sleep Timer: When the tuner is in use, these numbers indicate the specific preset memory location in use. (See page 26 for more information on preset stations.) When the Sleep function is in use, these numbers show how many minutes remain before the unit goes into the Standby mode.

K Night Mode Indicator: This indicator lights when the AVR 120 is in the Night mode, which preserves the dynamic range of digital program material at low volume levels.

L Speaker/Channel Input Indicators: These indicators are multipurpose, indicating either the speaker type selected for each channel or the

incoming data-signal configuration. The left, center, right, right surround and left surround speaker indicators are composed of three boxes, while the subwoofer is a single box. The center box lights when a "small" speaker is selected, and the two outer boxes light when "large" speakers are selected. When none of the boxes are lit for the center, surround or subwoofer channels, no speaker has been assigned to one of those positions. (See page 17 for more information on configuring speakers.) The letters inside each of the center boxes display active input channels. For standard analog inputs, only the L and R will light, indicating a stereo input. When a digital source is playing, the indicators will light to display the channels being received at the digital input. When the letters flash, the digital input has been interrupted. (See pages 18–19 for more information on the Channel Indicators.)

M Preset Indicator: This indicator lights when the tuner is in use to show that the **Preset Number/Sleep Timer J** is showing the station's preset memory number. (See page 26 for more information on tuner presets.)

N Sleep Indicator: This indicator lights when the Sleep function is in use. The numbers in the Preset Number/Sleep Timer Indicators will show the minutes remaining before the AVR 120 goes into the Standby mode. (See page 21 for more information on the Sleep function.)

Front Panel Information Display

M Memory Indicator: This indicator flashes when entering presets and other information into the tuner's memory.

P Stereo Indicator: This indicator lights when an FM station is being tuned in stereo.

T Tuned Indicator: This indicator lights when a station is being received with sufficient signal strength to provide acceptable listening quality.

R Auto Indicator: This indicator lights when the tuner's Auto mode is in use.

S Analog Input Indicator: This indicator lights when an analog input source has been selected.

D Coaxial Digital Input Indicators: These indicators light to show when a Coaxial Digital Input has been selected.

O Optical Digital Input Indicators: These indicators light to show when an Optical Digital Input has been selected.

Rear Panel Connections

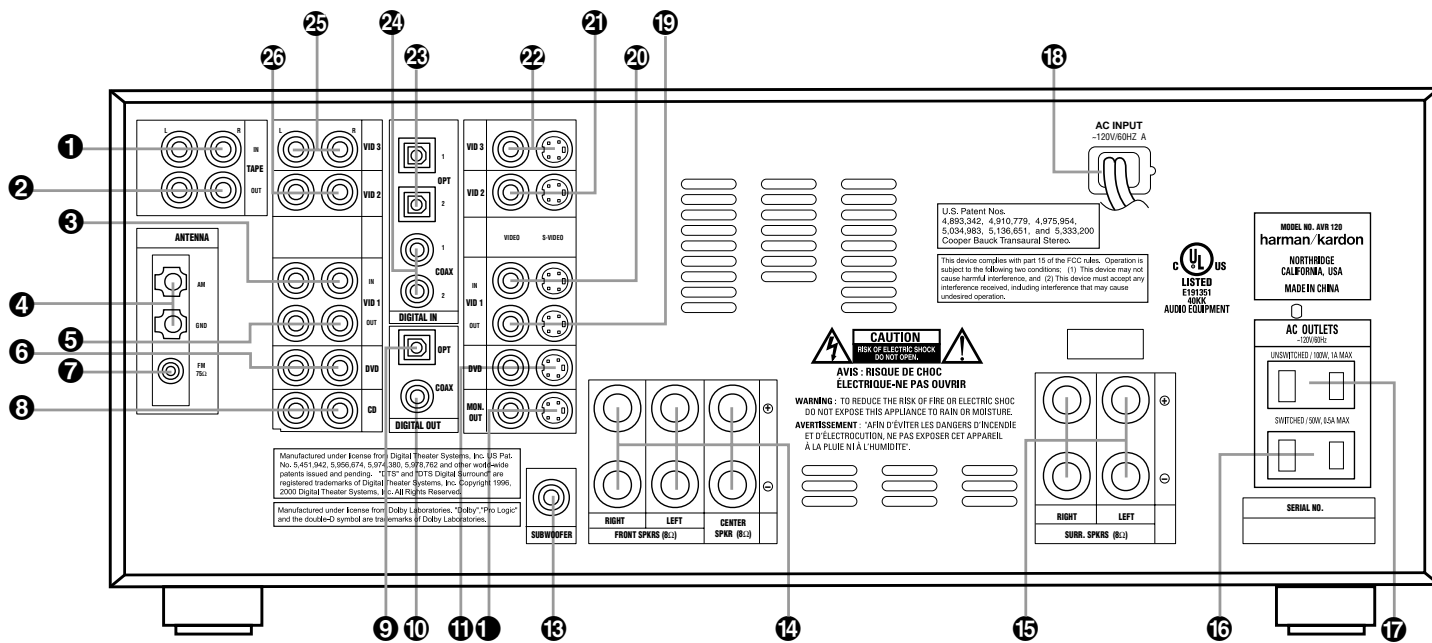

- 1 Tape Inputs
- 2 Tape Outputs
- 3 Video 1 Audio Inputs
- 4 AM Antenna
- 5 Video 1 Audio Outputs
- 6 DVD Audio Inputs
- 7 FM Antenna
- 8 CD Inputs
- 9 Optical Digital Output
- 10 Coaxial Digital Output

- 11 DVD Video Inputs
- 12 Video Monitor Outputs
- 13 Subwoofer Output
- 14 Front Speaker Outputs
- 15 Surround Speaker Outputs
- 16 Switched AC Accessory Outlet
- 17 Unswitched AC Accessory Outlet
- 18 AC Power Cord
- 19 Video 1 Video Outputs
- 20 Video 1 Video Inputs

- 21 Video 2 Video Inputs
- 22 Video 3 Video Inputs
- 23 Optical Digital Inputs
- 24 Coaxial Digital Inputs
- 25 Video 3 Audio Inputs
- 26 Video 2 Audio Inputs

Rear Panel Connections

1 Tape Inputs: Connect these jacks to the **PLAY/OUT** jacks of an audio recorder.

2 Tape Outputs: Connect these jacks to the **RECORD/INPUT** jacks of an audio recorder.

3 Video 1 Audio Inputs: Connect these jacks to the **PLAY/OUT** audio jacks on a VCR or other video source.

4 AM Antenna: Connect the AM loop antenna supplied with the receiver to these terminals. If an external AM antenna is used, make connections to the **AM** and **GND** terminals in accordance with the instructions supplied with the antenna.

5 Video 1 Audio Outputs: Connect these jacks to the **RECORD/INPUT** audio jacks on a VCR.

6 DVD Audio Inputs: Connect these jacks to the analog audio jacks on a DVD or other video source.

NOTE: The default setting for the audio input associated with DVD is the **Coaxial Digital Input 1** 24. If you connect the audio outputs of a DVD player to these jacks, change the input setting as shown on page 20.

7 FM Antenna: Connect the supplied indoor or an optional external FM antenna to this terminal.

8 CD Inputs: Connect these jacks to the output of a compact disc player or CD changer.

9 Optical Digital Output: Connect this jack to the matching digital input connector on a digital recorder such as CD-R or MiniDisc recorder.

10 Coaxial Digital Output: Connect this jack to the matching digital input connector on a digital recorder such as a CD-R or MiniDisc recorder.

11 DVD Video Inputs: Connect these jacks to the composite or S-Video output jacks on a DVD or other video source.

1 Video Monitor Outputs: Connect this jack to the composite or S-Video input of a TV monitor or video projector to view the output of any standard video source selected by the receiver's video switcher.

13 Subwoofer Output: Connect this jack to the line-level input of a powered subwoofer. If an external subwoofer amplifier is used, connect this jack to the subwoofer amplifier input.

14 Front Speaker Outputs: Connect these outputs to the matching + or – terminals on your front speakers. When making speaker connections, always make certain to maintain correct polarity by connecting the black terminal to the negative (–) terminal on the speakers. Connect the white terminal to the positive (+) terminal on the left front speaker, the red terminal to the positive (+) terminal on the right front speaker and the green terminal to the positive (+) terminal on the center front speaker. Newer speakers will have matching color terminals in accordance with the new CEA specifications, while existing speakers typically use a red terminal for the positive (+) speaker wire connection. (See page 14 for more information on speaker polarity.)

15 Surround Speaker Outputs: Connect these outputs to the matching + or – terminals on your left and right surround speakers. When making speaker connections always make certain to maintain correct polarity by connecting the black terminal to the negative (–) terminal on the speakers. Connect the blue terminal to the positive (+) terminal on the left surround speaker and the gray terminal to the positive (+) terminal on the right surround speaker. Newer speakers will have matching color terminals in accordance with the new CEA specifications, while existing speakers typically use a red terminal for the positive (+) speaker wire connection. (See page 14 for more information on speaker polarity.)

16 Switched AC Accessory Outlet: This outlet may be used to power any device you wish to have turned on when the AVR 120 is turned on with the **System Power Control Switch** 2.

17 Unswitched AC Accessory Outlet: This outlet may be used to power any AC device. The power will remain on at this outlet regardless of whether the AVR 120 is on or off.

NOTE: The total power consumption of all devices connected to the accessory outlets should not exceed 100 watts.

18 AC Power Cord: Connect the AC plug to an unswitched AC wall output.

19 Video 1 Video Outputs: Connect these jacks to the **RECORD/INPUT** composite or S-Video jack on a VCR.

20 Video 1 Video Inputs: Connect these jacks to the **PLAY/OUT** composite or S-Video jacks on a VCR or other video source.

21 Video 2 Video Inputs: Connect these jacks to the **PLAY/OUT** composite or S-Video jacks on a TV, VCR or other video source.

22 Video 3 Video Inputs: Connect these jacks to the **PLAY/OUT** composite or S-Video jacks on a cable television box, satellite dish receiver, VCR or other video source.

23 Optical Digital Inputs: Connect the optical digital output from a DVD player, HDTV receiver, LD player, satellite receiver, cable box, MiniDisc player or recorder, or CD player to these jacks. The signal may be either a Dolby Digital signal, a DTS signal or a standard PCM digital source.

24 Coaxial Digital Inputs: Connect the coax digital output from a DVD player, HDTV receiver, LD player, satellite receiver, cable box, MiniDisc recorder or CD player to these jacks. The signal may be either a Dolby Digital signal, DTS signal or a standard PCM digital source. Do not connect the RF digital output of an LD player to these jacks.

25 Video 3 Audio Inputs: Connect these jacks to the **PLAY/OUT** audio jacks on a VCR, satellite receiver, cable box, video game or other composite video source.

26 Video 2 Audio Inputs: Connect these jacks to the **PLAY/OUT** audio jacks on a VCR, satellite receiver, cable box, video game or other composite video source.

Remote Control Functions

- ❶ Power Off Button
- ❷ IR Transmitter Window
- ❸ Program Indicator
- ❹ Power On Button
- ❺ Input Selectors
- ❻ AVR Selector
- ❼ AM/FM Tuner Select
- ❽ Test Button
- ❾ Sleep Button
- ❿ Surround Mode Selector
- ⓫ Night Mode
- ⓬ Channel Select Button
- ⓭ ▲ Button
- ⓮ ◀ Button
- ⓯ Set Button
- ⓰ Digital Select
- ⓱ ▼ Button
- ⓲ Numeric Keys
- ⓳ Tuner Mode
- ⓴ Direct Button
- ⓵ Tuning Up/Down
- ⓶ Macro Buttons
- ⓷ Transport Controls
- ⓸ Skip Up/Down Buttons
- ⓹ Disc Skip Button
- ⓺ Preset Up/Down
- ⓻ Clear Button
- ⓼ Memory Button
- ⓽ Delay/Prev. Ch.
- ⓾ ► Button
- ⓿ Speaker Select
- ⓿ Spare Button
- ⓿ Volume Up/Down
- ⓿ TV/Video Selector
- ⓿ Mute

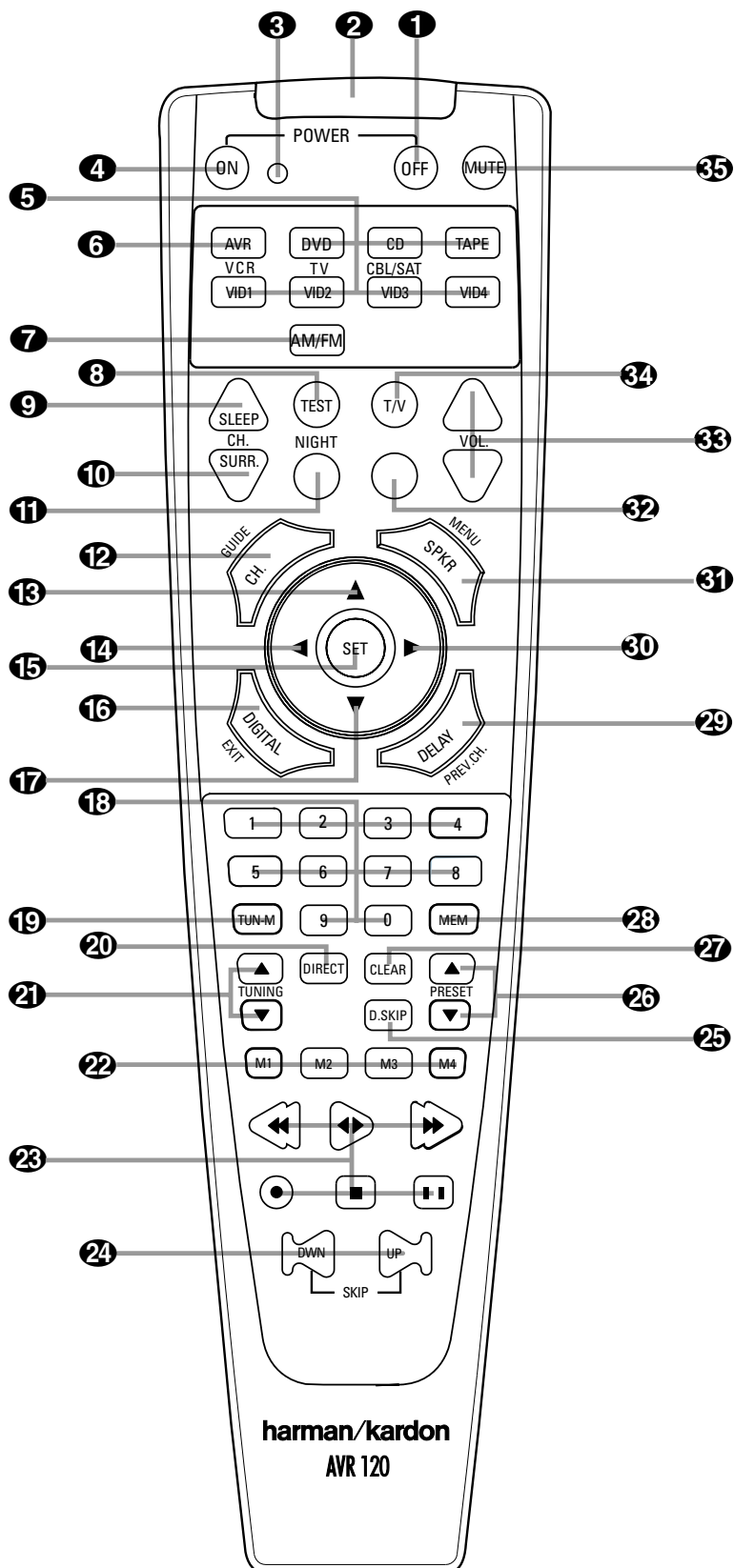

NOTE: The function names shown here refer to each button's feature when used with the AVR 120. Most buttons have additional functions when used with other devices. See pages 31–32 for a list of these functions.

Remote Control Functions

IMPORTANT NOTE: The AVR 120's remote may be programmed to control up to eight devices, including the AVR 120. Before using the remote, it is important to remember to press the **Input Selector Button 5** that corresponds to the unit you wish to operate. In addition, the AVR 120's remote is shipped from the factory to operate the AVR 120 and most Harman Kardon CD or DVD players and cassette decks. The remote is also capable of operating a wide variety of other products using the control codes that are part of the remote. Before using the remote with other products, follow the instructions on pages 27–30 to program the proper codes for the products in your system.

It is also important to remember that many of the buttons on the remote take on different functions, depending on the product selected using the Device Control Selectors. The descriptions shown here primarily detail the functions of the remote when it is used to operate the AVR 120. (See pages 31–32 for information about alternate functions for the remote's buttons.)

1 Power Off Button: Pressing this button turns off (places in the Standby mode) the device that was last selected by pressing one of the **Input Selectors 5**. To place the AVR 120 in the Standby mode, first press the **AVR Selector Button 6** and then press this button.

2 IR Transmitter Window: Point this window towards the AVR 120 when pressing buttons on the remote to make certain that infrared commands are properly received.

3 Program Indicator: This three-color indicator is used to guide you through the process of programming the remote. (See pages 27–30 for information on programming the remote.)

4 Power On Button: Press this button to turn on power to the device that was last selected by pressing one of the **Input Selectors 5**. To turn on the AVR 120, press the **AVR Selector Button 6**.

5 Input Selectors: Pressing one of these buttons will perform three actions at the same time. First, if the AVR 120 is not turned on, this will power up the unit. Next, it will select the source shown on the button as the input to the AVR 120. Finally, it will change the remote control so that it controls the device selected. After pressing one of these buttons you must press the **AVR Selector Button 6** again to operate the AVR 120's functions with the remote.

6 AVR Selector: Pressing this button will switch the remote so that it will operate the AVR 120's functions. If the AVR 120 is in the Standby mode, it will also turn the AVR 120 on.

7 AM/FM Tuner Select: Press this button to select the AVR 120's tuner as the listening choice. Pressing this button when the tuner is already in use will switch between the AM and FM bands.

8 Test Button: Press this button to begin the sequence used to calibrate the AVR 120's output levels. (See pages 18–19 for more information on calibrating the AVR 120.)

9 Sleep Button: Press this button to place the unit in the Sleep mode. After the time shown in the display, the AVR 120 will automatically go into the Standby mode. Each press of the button changes the time until turn-off in the following order:

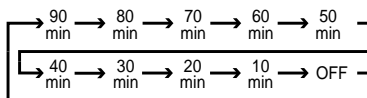

Note that this button is also used to change channels on your TV when the TV is selected.

This button is also used to end the process of creating a macro command. (See page 28 for more information on creating macros.)

10 Surround Mode Selector: Press this button to begin the process of changing the surround mode. After the button has been pressed, use the **▲/▼ Buttons 13 17** to select the desired surround mode. (See page 22 for more information.) Note that this button is also used to tune channels when the TV is selected using the device **Input Selector 5**. This button is also used in part of the process of erase stored macro commands. (See page 28 for more information on macros.)

NOTE: The **Sleep Button 9** and **Surround Mode Selector 10** may also function as the Channel + and – keys when the remote is programmed for use with TVs, cable boxes, VCRs, satellite receivers or other video devices with tuners. See page 29 for information on programming the remote for Channel Control Punch-Through capability so that you may change channels on a separate device when the remote is in AVR mode.

11 Night Mode: Press this button to activate the Night mode. This mode is available in specially encoded digital sources, and it preserves

dialog (center channel) intelligibility at low volume levels.

12 Channel Select Button: This button is used to start the process of setting the AVR 120's output levels to an external source. Once this button is pressed, use the **▲/▼ Buttons 13 17** to select the channel being adjusted, then press the **Set Button 15**, followed by the **▲/▼ Buttons 13 17** again, to change the level setting. (See page 26 for more information.)

13 ▲ Button: This multipurpose button is used to change or scroll through items in the menus, or to change configuration settings such as output levels. When changing an item such as the surround mode or digital input directly, first press the function or mode to be changed (e.g., press the **Surround Mode Selector 10** to select a surround mode or the **Digital Select Button 16** to change the digital input) and then press this button to scroll through the list of available choices.

14 ◀ Button: This button is used to change the menu selection or setting during some of the setup procedures for the AVR 120.

15 Set Button: This button is used to enter settings into the AVR 120's memory. It is also used in the setup procedures for delay time, speaker configuration and channel output level adjustment.

16 Digital Select: Press this button to assign one of the digital inputs **23 24 13 14** to a source. (See page 23 for more information on using digital inputs.)

17 ▼ Button: This multipurpose button is used to change or scroll through items in the menus, or to change configuration settings such as output levels. When changing an item such as the surround mode or digital input directly, first press the function or mode to be changed (e.g., press the **Surround Mode Selector 10** to select a surround mode or the **Digital Select Button 16** to change the digital input) and then press this button to scroll through the list of available choices.

18 Numeric Keys: These buttons serve as a ten-button numeric keypad to enter tuner preset positions. They are also used to select channel numbers when **TV** has been selected on the remote, or to select track numbers on a CD, DVD or LD player, depending on how the remote has been programmed.

Remote Control Functions

19 Tuner Mode: Press this button when the tuner is in use to select between automatic tuning and manual tuning. When the button is pressed so that the **AUTO Indicator** **R** goes out, pressing the **Tuning Buttons** **21** **18** will move the frequency up or down in single-step increments. When the FM band is in use, pressing this button when a station's signal is weak will change to monaural reception. (See page 25 for more information.)

20 Direct Button: Press this button when the tuner is in use to start the sequence for direct entry of a station's frequency. After pressing the button simply press the proper **Numeric Keys** **18** to select a station. (See page 25 for more information on the tuner.)

21 Tuning Up/Down: When the tuner is in use, these buttons will tune up or down through the selected frequency band. If the **Tuner Mode Button** **19** **12** has been pressed so that the **AUTO Indicator** **R** is illuminated, pressing and holding either of the buttons for three seconds will cause the tuner to seek the next station with acceptable signal strength for quality reception. When the **AUTO Indicator** **R** is NOT illuminated, pressing these buttons will tune stations in single-step increments. (See page 25 for more information.)

22 Macro Buttons: Press these buttons to store or recall a "Macro", which is a preprogrammed sequence of commands stored in the remote. (See page 28 for more information on storing and recalling macros.)

23 Transport Controls: These buttons do not have any functions for the AVR 120, but they may be programmed for the forward/reverse play operation of a wide variety of CD or DVD players, and audio or video cassette recorders. (See page 30 for more information on programming the Transport Control Punch-Through capability of the remote.)

24 Skip Up/Down Button: These buttons have no direct function with the AVR 120, but when used with a compatibly programmed CD or DVD changer they will change the disc currently being played in the changer.

25 Disc Skip Button: This button has no direct function for the AVR 120, but is often used when the remote is programmed to operate a CD or DVD changer to change the discs in the changer. (See page 28 for more information on using the remote with other devices.)

26 Preset Up/Down: When the tuner is in use, press these buttons to scroll through the stations programmed into the AVR 120's memory. When some source devices, such as CD players, VCRs and cassette decks, are selected using the device **Input Selectors** **5**, these buttons may function as Chapter Step or Track Advance.

27 Clear Button: Press this button to clear incorrect entries when using the remote to directly enter a radio station's frequency.

28 Memory Button: Press this button to enter a radio station into the AVR 120's preset memory. Once the **MEMORY Indicator** **O** flashes, you have five seconds to enter a preset memory location using the **Numeric Keys** **18** (See page 26 for more information.)

29 Delay/Prev Ch.: Press this button to begin the process for setting the delay times used by the AVR 120 when processing surround sound. After pressing this button, the delay times are entered by pressing the **Set Button** **15** and then using the **▲/▼ Buttons** **13** **17** to change the setting. Press the **Set Button** **15** again to complete the process. (See page 19 for more information.)

30 ► Button: Press this button to change a setting or selection when configuring many of the AVR 120's settings.

31 Speaker Select: Press this button to begin the process of configuring the AVR 120's bass management system for use with the type of speakers used in your system. Once the button has been pressed, use the **▲/▼ Buttons** **13** **17** to select the channel you wish to set up. Press the **Set Button** **15** and then select another channel to configure. When all adjustments have been completed, press the **Set Button** **15** twice to exit the settings and return to normal operation. (See page 17 for more information.)

32 Spare Button: This button does not have any function for the operation of the AVR 120, but it is available for use when programmed with the code from another remote. (See page 27 for information on programming the remote with codes for other devices.)

33 Volume Up/Down: Press these buttons to raise or lower the system volume. See page 29 for more information on programming the

Volume Control Punch-Through capability of the remote, which allows you to change the AVR 120's volume while the remote is set to control another device.

34 TV/Video Selector: This button does not have a direct function on the AVR 120, but when used with a compatibly programmed VCR, DVD or satellite receiver that has a "TV/Video" function, pressing this button will switch between the output of the player or receiver and the external video input to that player. Consult the owner's manual for your specific player or receiver for the details of how it implements this function.

35 Mute: Press this button to momentarily silence the AVR 120 or TV set being controlled, depending on which device has been selected. When the AVR 120 is muted, press this button or use the **Volume Control** **20** **33** to return to the previous volume level. When the AVR 120 remote is being programmed to operate another device or when a macro command is being programmed, this button is pressed with the **Input Selector Button** **5** to begin the programming process. (See page 27 for more information on programming the remote.)

Installation and Connections

System Installation

After unpacking the unit, and placing it on a solid surface capable of supporting its weight, you will need to make the connections to your audio and video equipment.

Audio Equipment Connections

We recommend that you use high-quality interconnect cables when making connections to source equipment and recorders to preserve the integrity of the signals.

When making connections to audio source equipment or speakers it is always a good practice to unplug the unit from the AC wall outlet. This prevents any possibility of accidentally sending audio or transient signals to the speakers that may damage them.

1. Connect the analog output of a CD player to the **CD Inputs ③**.

NOTE: When the CD player has both fixed and variable audio outputs it is best to use the fixed output unless you find that the input to the receiver is so low that the sound is noisy, or so high that the signal is distorted.

2. Connect the analog Play/Out jacks of a cassette deck, MD, CD-R or other audio recorder to the **Tape Input Jacks ①**. Connect the analog Record/In jacks on the recorder to the **Tape Output Jacks ②** on the AVR 120.

3. Connect the output of any digital sources to the appropriate input connections on the AVR 120 rear panel. Note that the **Optical and Coaxial Digital Inputs ⑧⑨⑩⑪** may be used with a Dolby Digital or DTS source or the output of a conventional CD or LD player's PCM (S/P-DIF) output. To take advantage of the AVR 120's built-in MP3-decoding capabilities, you may also connect the digital output of a computer or sound card to this input, provided that the signal from the computer is in the S/P-DIF format. Check your computer or sound card's instructions to verify the type of output signal or use a transcoder such as the Harman Kardon DAL 150.

4. Connect the **Optical Digital Output ⑨** or **Coaxial Digital Output ⑩** on the rear panel of the AVR 120 to the matching digital input connections on a CD-R or MiniDisc recorder.

5. Assemble the AM Loop Antenna supplied with the unit as shown below. Connect it to the **AM and GND Screw Terminals ④**.

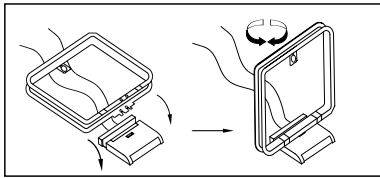

6. Connect the supplied FM antenna to the **FM Antenna (75 ohm) Connection ⑦**. The FM antenna may also be an external roof antenna, an inside powered or wire lead antenna or a connection from a cable TV system. Note that if the antenna or connection uses 300-ohm twin-lead cable, you must use the 300-ohm-to-75-ohm adapter supplied with the unit to make the connection.

7. Connect the front, center and surround **Speaker Outputs ⑭ ⑮** to the respective speakers.

To ensure that all the audio signals are carried to your speakers without loss of clarity or resolution, we suggest that you use high-quality speaker cable. Many brands of cable are available and the choice of cable may be influenced by the distance between your speakers and the receiver, the type of speakers you use, personal preferences and other factors. Your dealer or installer is a valuable resource to consult in selecting the proper cable.

Regardless of the brand of cable selected, we recommend that you use a cable constructed of fine, multistrand copper with a gauge of 14 or smaller. Remember that in specifying cable, the lower the number, the thicker the cable.

Cable with a gauge of 16 may be used for short runs of less than ten feet. We do not recommend that you use cables with an AWG equivalent of 18 or higher due to the power loss and degradation in performance that will occur.

Cables that are run inside walls should have the appropriate markings to indicate listing with UL, CSA or other appropriate testing agency standards. Questions about running cables inside walls should be referred to your installer or a licensed electrical contractor who is familiar with the NEC and/or the applicable local building codes in your area.

When connecting wires to the speakers, be certain to observe proper polarity. Remember to connect the "negative" or "black" wire to the same terminal on both the receiver and the

speaker. The AVR 120 is one of the first audio products with the latest CEA-recommended color-coding for speaker terminals. Accordingly, the positive (+) terminal, which was previously red, is now a specific color to assist you in making the correct connections. If your speakers have color-coded connections, match the terminal on the AVR 120 to the like terminal on your speakers. For existing speakers with a red terminal for the positive connection, the connections on the AVR 120 are as follows:

Left Front = White Right Front = Red
Center = Green
Left Surround = Blue Right Surround = Grey

NOTE: While most speaker manufacturers adhere to an industry convention of using black terminals for negative and red ones for positive, some manufacturers may vary from this configuration. To ensure proper phase and optimal performance, consult the identification plate on your speaker or the speaker's manual to verify polarity. If you do not know the polarity of your speaker, ask your dealer for advice before proceeding, or consult the speaker's manufacturer.

We also recommend that the length of cable used to connect speaker pairs be identical. For example, use the same length piece of cable to connect the front-left and front-right or surround-left and surround-right speakers, even if the speakers are a different distance from the AVR 120.

8. Connections to a subwoofer are normally made via a line-level audio connection from the **Subwoofer Output ⑬** to the line-level input of a subwoofer with a built-in amplifier. When a passive subwoofer is used, the connection first goes to a power amplifier, which will be connected to one or more subwoofer speakers. If you are using a powered subwoofer that does not have line-level input connections, follow the instructions furnished with the speaker for connection information.

Video Equipment Connections

Video equipment is connected in the same manner as audio components. Again, the use of high-quality interconnect cables is recommended to preserve signal quality.

1. Connect a VCR's audio and video Play/Out jacks to the **Video 1 Input Jacks ⑳㉑** on the rear panel. The Audio and Video Record/In jacks on the VCR should be connected to the **Video 1 Out Jacks ㉕㉖** on the AVR 120.

Installation and Connections

2. Connect the analog audio and video outputs of a satellite receiver, cable TV converter or television set or any other video source to the **Video 2 or Video 3 Jacks** ①②⑤⑥.

3. Connect the analog audio and video outputs of a DVD or laser disc player to the **DVD Jacks** ⑥⑪. When a digital audio connection is used for your DVD player, the default connection is the **Coaxial Digital Input 1 Jack** ⑭. However, the connection may also be made to any of the **Optical** ⑮⑲ or **Coaxial** ⑳㉑ **Digital Inputs**, provided that the digital input source selection is changed as shown on page 23.

4. Connect the digital audio outputs of a DVD player, satellite receiver, cable box or HDTV converter to the appropriate **Optical** or **Coaxial Digital Inputs** ⑮⑲⑳㉑.

5. Connect the **Video Monitor Output** ① jacks on the receiver to the composite or S-Video input of your television monitor or video projector.

Video Connection Note:

- Composite and S-Video signals may only be viewed in their native formats.

Power Connections

This unit is equipped with two accessory AC outlets. They may be used to power accessory devices, but they should not be used with high-current draw equipment such as power amplifiers. The total power draw to each outlet may not exceed 100 watts.

The **Switched AC Accessory Outlet** ⑫ will receive power only when the unit is on. This is recommended for devices that have no power switch or a mechanical power switch that may be left in the "ON" position.

NOTE: Many audio and video products go into a Standby mode when they are used with switched outlets, and cannot be fully turned on using the outlet alone without a remote control command.

The **Unswitched AC Accessory Outlet** ⑬ will receive power as long as the unit is plugged into a powered AC outlet.

Finally, when all connections are complete, plug the **Power Cord** ⑬ into a nonswitched 120-volt AC wall outlet. You're almost ready to enjoy the AVR 120!

System Configuration

When all audio, video and system connections have been made, there are a few configuration adjustments that must be made. A few minutes spent to correctly configure and calibrate the unit will greatly add to your listening experience.

Speaker Selection and Placement

The placement of speakers in a multichannel home theater system can have a noticeable impact on the quality of sound reproduced.

No matter which type or brand of speakers is used, the same model or brand of speaker should be used for the left front, center and right front speakers. This creates a seamless front soundstage and eliminates the possibility of distracting sonic disturbances that occur when a sound moves across mismatched front-channel speakers.

Speaker Placement

Depending on the type of center-channel speaker in use and your viewing device, place the center speaker either directly above or below your TV, or in the center behind a perforated front projection screen.

Once the center-channel speaker is installed, position the left front and right front speakers so that they are as far away from one another as the center-channel speaker is from the preferred listening position. Ideally, the front-channel speakers should be placed so that their tweeters are no more than 24" above or below the tweeter in the center-channel speaker.

Depending on the specifics of your room acoustics and the type of speakers in use, you may find that imaging is improved by moving the left front and right front speakers slightly forward of the center-channel speaker. If possible, adjust all front loudspeakers so that they are aimed at ear height when you are seated in the listening position.

Using these guidelines, you'll find that it takes some experimentation to find the correct location for the front speakers in your particular installation. Don't be afraid to move things around until the system sounds correct. Optimize your speakers so that audio transitions across the front of the room sound smooth, and that sounds from all speakers appear to arrive at the

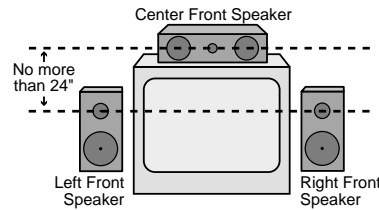

A) Front-Channel Speaker Installation with Direct-View TV Sets or Rear-Screen Projectors

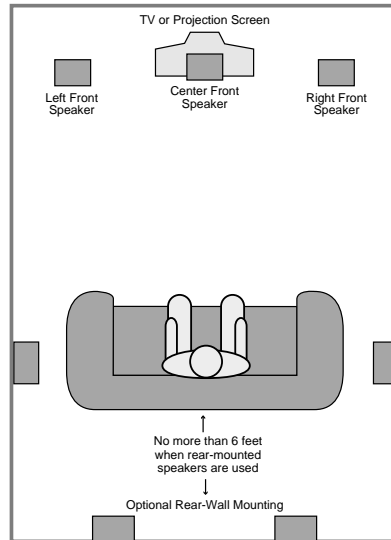

B) The distance between the left and right speakers should be equal to the distance from the seating position to the viewing screen. You may also experiment with placing the left and right speakers slightly forward of the center speaker.

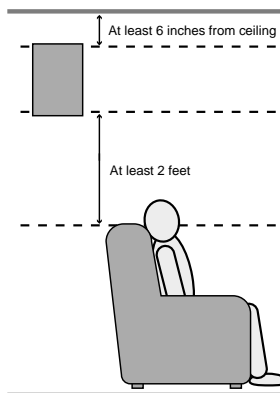

C) Optimal placement of surround speaker

listening position at the same time (without delay from the center speaker compared to the left and right speakers).

Surround speakers should be placed on the side walls of the room, at or slightly behind the listening position. The center of the speaker should face into the room. The speakers should be located so that the bottom of the cabinet is at least two feet higher than the listeners' ears when the listeners are seated in the desired area.

If side-wall mounting is not practical, the speakers may be placed on a rear wall, behind the listening position. Again, they should be located so that the bottom of the cabinet is at least two feet higher than the listeners' ears. The speakers should be no more than six feet behind the rear of the seating area.

Subwoofers produce nondirectional sound, so they may be placed almost anywhere in a room. Actual placement should be based on room size and shape and the type of subwoofer used. One method of finding the optimal location for a subwoofer is to begin by placing it in the front of the room, about six inches from a wall, or near the front corner of the room. Another method is to temporarily place the subwoofer at your normal listening position, and then walk around the room until you find a spot where the subwoofer sounds best. Place the subwoofer in that spot. You should also follow the instructions of the subwoofer's manufacturer, or you may wish to experiment with the best location for a subwoofer in your listening room.

Once the speakers have been placed in the room and connected, the remaining steps in the setup process are to program the AVR 120's bass management system for the type of speakers used in your system, calibrate the output levels, and set the delay times used by the surround sound processor.

System Configuration

You are now ready to power up the AVR 120 to begin these final adjustments.

1. Plug the **Power Cord** **18** into an unswitched AC outlet.
2. Press the **Main Power Switch** **1** in until it latches and the word "OFF" on the top of the switch disappears inside the front panel. Note that the **Power Indicator** **3** will turn amber, indicating that the unit is in the Standby mode.
3. Remove the protective plastic film from the front-panel lens. If left in place, the film may affect the performance of your remote control.
4. Install the three supplied AAA batteries in the remote as shown. Be certain to follow the (+) and (-) polarity indicators that are on the bottom of the battery compartment.

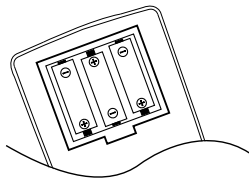

5. Turn the AVR 120 on either by pressing the **System Power Control** **2** on the front panel, or via the remote by pressing the **AVR Selector** **6** or any of the **Input Selectors** **5** **7** on the remote. The **Power Indicator** **3** will turn green to confirm that the unit is on, and the **Main Information Display** **25** will also light up.

System Setup

The AVR 120 features an advanced memory system that enables you to establish different configurations for the bass management, digital input, surround mode, delay times and output levels for each input source. This flexibility enables you to custom-tailor the way in which you listen to each source and have the AVR 120 memorize those settings. This means, for example, that you may use different output levels or trims for different sources, or set different speaker configurations with the resultant changes to the bass management system. Once these settings are made, they will automatically be recalled whenever you select that input.

The factory default settings for the AVR 120 have all inputs configured for an analog source (except for the DVD input, which has the **Coaxial Digital Input 1** **24** as the default), Stereo as the surround mode, all speaker positions set to "small," and a subwoofer connected. Before using the unit, you will probably want to change the settings for most inputs so that they are properly configured to reflect the use of digital or analog inputs, the type of speakers installed and the surround mode specifics. Remember that since the AVR 120 memorizes the settings for each input individually, you will need to make these adjustments for each input used. However, once they are made, further adjustment is only required when system components are changed.

Once you have completed the settings for the first input, many settings may be duplicated for the remaining inputs. Remember that once the settings are entered for one input, they must be completed for all other input sources in your system.

Speaker Setup

These adjustments tell the AVR 120 which type of speakers are in use. This is important as it adjusts the settings that determine which speakers receive low-frequency (bass) information. For each of these settings use the **LARGE** setting if the speakers for a particular position are traditional full-range loudspeakers that are capable of reproducing sounds below 100Hz. Use the **SMALL** setting for smaller, frequency-limited satellite speakers that do not reproduce sounds below 100Hz. Note that when "small" speakers are used, a subwoofer is required to reproduce low-frequency sounds. Remember that the "large" and "small" descriptions do not refer to the actual physical size of the speakers, but to their ability to reproduce low-frequency sounds. If you are in doubt as to which category describes your speakers, consult the specifications in the speakers' owner's manual, or ask your dealer.

With the AVR 120 turned on, follow these steps to configure the speakers:

1. Put the AVR 120 in the Dolby Pro Logic II mode by pressing the **Surround Mode Selector** **7** on the front panel or by press-

ing the **Surround Mode Selector** **10** on the remote, until **PRO LOGIC II** appears in the **Main Information Display** **F** and the **Pro Logic II Indicator** **D** lights.

2. Press the **Speaker Select Button** **31** **27** on the remote or front panel. The words **FNT SPEAKER** will appear in the **Main Information Display** **F**.
3. Press the **Set Button** **15** **21**.
4. Press the **▲/▼ Buttons** **13** **17** on the remote or the **Selector Buttons** **5** on the front panel until either **LARGE** or **SMALL** appears, matching the type of speakers you have at the left-front and right-front positions, as described by the definitions shown in the preceding section.

When **SMALL** is selected, low-frequency sounds will be sent to the subwoofer output only. Note that if you choose this option, and there is no subwoofer connected, you will not hear any low-frequency sounds from the front channels.

When **LARGE** is selected, a full-range output will be sent to the front-left and front-right outputs, and NO low-frequency signals will be sent to the subwoofer output.

5. When you have completed your selection for the front channel, press the **Set Button** **15** **21**, and then press the **▲/▼ Buttons** **13** **17** on the remote or the **Selector Buttons** **5** on the front panel to change the display to **CEN SPEAKER**.
6. Press the **Set Button** **15** **21** again, and use the **▲/▼ Buttons** **13** **17** on the remote, or the **Selector Buttons** **5** on the front panel, to select the option that best describes your system based on the speaker definitions shown in the preceding section.

When **CEN SMALL** is selected, low-frequency center-channel sounds will be sent to the subwoofer output only. Note that if you choose this option and there is no subwoofer connected, you will not hear any low-frequency sounds from the center-channel speaker.

When **CEN LARGE** is selected, a full-range output will be sent to the center-speaker output, and NO center-channel signal will be sent to the subwoofer output.

System Configuration

NOTE: If you choose Logic 7 as the surround mode for the particular input source for which you are configuring your speakers, the AVR 120 will not make the LARGE option available for the center speaker. This is due to the requirements of Logic 7 processing, and does not indicate a problem with your receiver.

When **CEN NONE** is selected, no signals will be sent to the center-channel output.

- When you have completed your selection for the center channel, press the **Set Button** **15 21**, and then press the **Left/Right Buttons** **14 30** on the remote or the **Selector Buttons** **5** on the front panel to change the display to **SUR SPEAKER**.
- Press the **Set Button** **15 21** again, and then use the **Up/Down Buttons** **13 17** on the remote or the **Selector Buttons** **5** on the front panel to select the option that best describes your system based on the speaker definitions shown in the preceding section.

When **SUR SMALL** is selected, low-frequency surround-channel sounds will be sent to the subwoofer output only. Note that if you choose this option and there is no subwoofer connected, you will not hear any low-frequency sounds from the surround speaker.

When **SUR LARGE** is selected, a full-range output will be sent to the surround-channel outputs, and NO surround-channel signals will be sent to the subwoofer output.

When **SUR NONE** is selected, surround sound information will be split between the front-left and front-right outputs. Note that for optimal performance when no surround speakers are in use, the Dolby 3 Stereo mode should be used instead of Dolby Pro Logic II.

- When you have completed your selection for the surround channel, press the **Set Button** **15 21**, and then press **Up/Down Buttons** **13 17** on the remote or the **Selector Buttons** **5** on the front panel to change the display to **S - W SPEAKER**.

- Press the **Set Button** **15 21**, and then press the **Up/Down Buttons** **13 17** on the remote or the **Selector Buttons** **5** on the front panel to select the option that best describes your system.

The choices available for the subwoofer position will depend on the settings for the other speakers, particularly the front left/right positions.

If the front left/right speakers are set to **SMALL**, the subwoofer will automatically be set to **SUB**, which is the "on" position.

If the front left/right speakers are set to **LARGE**, three options are available:

- If no subwoofer is connected to the AVR 120, press the **Up/Down Buttons** **13 17** on the remote so that **SUB NONE** appears in the **Main Information Display** **6**. When this option is selected, all bass information will be routed to the front left/right "main" speakers.
- If a subwoofer is connected to the AVR 120, you have the option to have the front left/right "main" speakers reproduce bass frequencies at all times, and have the subwoofer operate only when the AVR 120 is being used with a digital source that contains a dedicated Low-Frequency Effects, or LFE, soundtrack. This allows you to use both your main and subwoofer speakers to take advantage of the special bass created for certain movies. Press **Up/Down Buttons** **13 17** on the remote so that **SUB (LFE)** appears in the **Main Information Display** **6**.
- If a subwoofer is connected and you wish to use it for bass reproduction in conjunction with the main front left/right speakers, regardless of the type of program source or surround mode you are listening to, press the **Up/Down Buttons** **13 17** on the remote so that **SUB L / R + LFE** appears in the **Main Information Display** **6**. When this option is selected, a "complete" feed will be sent to the front left/right "main" speakers, and the subwoofer will receive bass frequencies below 100Hz.

- When all speaker selections have been made, press the **Set Button** **15 21** to return to normal operation.

Output Level Adjustment

Output level adjustment is a key part of the configuration process for any surround sound product. It is particularly important for a Dolby Digital receiver such as the AVR 120, as correct output levels will ensure that you hear sound tracks in their proper place with the proper directionality and intensity.

IMPORTANT NOTE: Listeners are often confused about the operation of the surround channels. While some assume that sound should always be coming from each speaker, most of the time there will be little or no sound in the surround channels. This is because they are only used when a movie director or sound mixer specifically places sound there to create ambiance, a special effect or to continue action from the front of the room to the rear. When the output levels are properly set, it is normal for surround speakers to operate only occasionally. Artificially increasing the volume to the rear speakers may destroy the illusion of an enveloping sound field that duplicates the way you hear sound in a movie theater or concert hall.

Before beginning the adjustment process, make certain that all speaker connections have been properly made. The system volume should be set to the level that you will use during a typical listening session. Finally, make certain that the **Balance Control** **18** is set to the center "12 o'clock" position.

To assist in making speaker configuration settings, the icons in the **Speaker/Channel Input Indicators** **14** change as the speaker type is selected at each position. When only the center icon box containing the abbreviation for the speaker position is lit, the speaker is set for "small." When the inner box and the two outer boxes are lit, the speaker is set for "large." When no indicator appears at a speaker location, that position is set for "none" or "no" speaker.

For example, in the following figure, the left front and right front speakers are set for "large," the center, surround left (SL) and surround right (SR) speakers are set for small, and a subwoofer is set, as shown by the box with the abbreviation "LFE", which stands for "low-frequency effects."

System Configuration

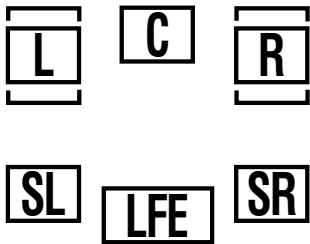

To adjust and calibrate the output levels, follow these steps. For accurate calibration, it is a good idea to make these adjustments while seated in your favorite listening position:

1. Put the AVR 120 in the Dolby Pro Logic II mode by pressing **Surround Mode Selector 7** on the front panel, or by pressing the **Surround Mode Selector 10** on the remote, until **PRO LOGIC II** scrolls across the **Main Information Display F** and the **Pro Logic II Indicators D 29** light.

2. Press the **Test Button 8** on the remote. **T - T FL 0dB** will appear in the **Main Information Display F** and the letters **FL** will flash once each second.

3. The test noise will immediately begin to circulate among the speakers in a clockwise rotation, pausing at each position for three seconds. As the test noise rotates, the speaker position will be shown in the **Main Information Display F**.

NOTE: This is a good time to verify that the speakers have been properly connected. As the test noise circulates, listen to make certain that the sound comes from the speaker position shown in the Main Information Display. If the sound from a speaker location does NOT match the position indicated in the display, turn the AVR 120 off using the **Main Power Switch 1** and check the speaker wiring to make certain that each speaker is connected to the correct output terminal.

4. After checking for speaker placement, let the test noise circulate, and listen to see which channels sound louder than the others. Using the front left (FL in the display) speaker as a reference, press the **▲/▼ Buttons 13 17** on the remote or the **Selector Buttons 5** on the front panel

for each channel to begin to bring them to the same level. Note that when one of the buttons is pushed, the test noise circulation will pause on the channel being adjusted to give you time to make the adjustment. When you release the button, the circulation will resume after 15 seconds.

5. Continue to adjust the individual speakers until they all have the same volume. Note that adjustments should be made with the **▲/▼ Buttons 13 17** on the remote or the **Selector Buttons 5** on the front panel only, NOT the main volume controls. Then press the **Set Button 15 21** to memorize the change. If you are using a sound pressure (SPL) meter for precise level adjustment, set the volume so that the meter reads 75dB, C-Weighting Slow.

NOTE: The subwoofer output level is not adjustable using the test tone. To change the subwoofer level, follow the steps for Output Level Trim Adjustment on page 26.

6. When you have adjusted the output so that all channels have the same level, press the **Test Button 8** on the remote to complete the adjustment.

Delay Settings

Due to the different distances between the front-channel speakers and the listening position compared to the surround speakers and the listening position, the amount of time it takes for sound to reach your ears from the front or surround speakers may differ. You may compensate for this difference through the use of the delay settings to adjust the timing to tailor the specific speaker placement and acoustic conditions in your listening room or home theater.

The factory setting is appropriate for most rooms, but some installations create an uncommon distance between the front and surround speakers that may cause the arrival of front-channel sounds to become disconnected from surround-channel sounds.

To resynchronize the front and surround channels, follow these steps:

1. Measure the distance from the listening/viewing position to the front speakers.
2. Measure the distance from the listening/viewing position to the surround speakers.

3. Subtract the distance to the surround speakers from the distance to the front speakers.

a. When setting the delay time for the Dolby Digital surround modes, the optimal delay time is the result of that subtraction. For example, if the front speakers are ten feet away and the surround speakers are five feet away, the optimal delay time is figured as $10-5=5$. Thus, in this example, the delay time for Dolby Digital should be set at five milliseconds.

b. When setting the delay time for the Pro Logic II mode, take the result of the subtraction and add 15 to obtain the optimal delay time. For example, if the front speakers are ten feet away and the surround speakers are five feet away, the optimal delay time is figured as $10-5+15=20$. Thus, in this example, the Pro Logic delay should be set at twenty milliseconds.

NOTE: The Theater and Hall modes use a fixed, nonadjustable delay time.

The Dolby Digital mode also includes a separate setting for the center-channel delay mode, since the discrete nature of these signals makes the location of the center-channel speaker more critical. To calculate the delay for the center channel, measure the distance from the preferred listening position in the center of the room to both the center-channel speaker and either the left or right speaker.

If the distances are equal, no further adjustment is required and the center delay should be set to zero. If the distance to the front speakers is greater than the distance to the center speaker, you may wish to reposition the speakers by moving the front-left and front-right speakers closer to the listening position or the center speaker further away from the listening position.

If repositioning of the speakers is not possible, adjust the center delay time, adding one millisecond of center-channel delay for every foot closer to the listening position the center speaker is than the front speaker. For example, if the front-left and front-right speakers are each 10 feet from the listening position and the center-channel speaker is 8 feet away, the delay is figured as $10-8=2$, suggesting an optimal center delay of 2 milliseconds.

System Configuration

To set the delay times, follow these steps:

1. Put the AVR 120 in the Dolby Pro Logic II mode by pressing the **Surround Mode Selector 7** on the front panel or by pressing the **Surround Mode Selector 10** on the remote, until **PRO LOGIC II** appears in the **Main Information Display F** and the **Pro Logic II Indicator D** lights up.
2. Press the **Delay Button 29 23** on the remote or front panel. The words **S DELAY TIME** will appear in the **Main Information Display F**.
3. Press the **Set Button 15 21**.
4. Adjust the delay time by pressing the **▲/▼ Buttons 13 17** on the remote or the **Selector Buttons 5** on the front panel until the delay time figure calculated using the formula entered above appears in the display.
5. If only analog sources will be used, no adjustment is needed for the center-channel delay. In that case, press the **Set Button 15 21** to enter the surround delay settings into the AVR 120's memory. However, if you will be using digital sources and the calculations outlined above indicate that the center-channel delay requires an adjustment, continue with the following steps.
6. Before setting the center-channel delay time, make certain that a digital source has been selected.
7. Select the Dolby Digital mode by pressing either the **Surround Mode Selector 7** on the front panel or the **Surround Mode Selector 10** on the remote, until **DOLBY DIG** appears in the **Main Information Display F**.
8. Press the **Delay Button 29 23** on the remote or front panel. The words **S DELAY TIME** will appear in the **Main Information Display F**.
9. Press the **Set Button 15 21**, and then immediately press the **▲/▼ Buttons 13 17** on the remote or the **Selector Buttons 5** on the front panel until the desired delay time for the surround channels is shown in the display.
10. Press the **Set Button 15 21** within three seconds after the desired setting is shown.
11. Press the **▲/▼ Buttons 13 17** on the remote once so that **C DELAY TIME** appears in the **Main Information Display F**.
12. Press the **Set Button 15 21**.
13. Press the **▲/▼ Buttons 13 17** on the remote or the **Selector Buttons 5** on the front panel until the desired delay time for the center channel appears in the display.
14. Press the **Set Button 15 21** to enter the setting into the AVR 120's memory.

Additional Input Adjustments

In addition to the major adjustments described in the preceding pages, you may also wish to set the type of audio source type (analog or digital) to be used with an input at this time. Once a specific audio source type is associated with any of the inputs, it will remain in the memory until it is changed, even when another input is selected. To attach one of the digital inputs to a specific source, follow these steps:

1. Press the **Digital Button 16 24**.
2. Immediately press the **▲/▼ Buttons 13 17** or **Selector Buttons 5** to scroll through the list of available digital inputs or the analog input.
3. When the desired input type is shown in both the **Main Information Display F** and in the **Analog S, Coaxial Digital Input T** or **Optical Digital Input U Indicators**, press the **Set Button 15 21** to enter the setting into the unit's memory.

You may also "memorize" a specific surround mode so that it will always be used when an input is selected. The AVR 120 always remembers the last surround mode used with any input, but during the setup process you may wish to preset the modes for each source. To do that, follow these steps:

1. Select an input by pressing one of the **Input Selectors 5 11** or the **AM/FM Tuner Select 7**.
2. Press the **Surround Mode Selector 10 7**, and immediately press the **▲/▼ Buttons 13 17** or **Surround Mode Selector 11** to scroll through the list of available surround modes. Note that the name of each mode will scroll from right to left across the **Main Information Display F**. To avoid having the system "time out" and exit the select process, be sure to press the **▲/▼ Buttons 13 17** or **Surround Mode Selector 11** to select the next mode at any time the mode name is displayed.
3. When the desired mode name appears in the **Main Information Display F** and in the **Surround Mode Indicators 29**, simply pause for a few seconds to allow the unit to "time out." Your selection will be memorized and will be activated each time the input is selected until another mode is selected.
4. Repeat the process for each of the inputs.
5. When the desired Surround mode has been entered for all inputs, press the **Set Button 15**.

Once the settings outlined on the previous pages have been made, the AVR 120 is ready for operation. While there are some additional settings to be made, these are best done after you have had an opportunity to listen to a variety of sources and different kinds of program material. These settings are described on pages 21 through 26 of this manual. In addition, any of the settings made in the initial configuration of the unit may be changed at any time. As you add new or different sources or speakers, or if you wish to change a setting to better reflect your listening taste, simply follow the instructions for changing the settings for that parameter, as shown in this section.

Having completed the setup and configuration process for your AVR 120, you are about to experience the finest in music and home theater listening. Enjoy!

Operation

Basic Operation

Once you have completed the setup and configuration of the AVR 120, it is simple to operate and enjoy. The following instructions will help you maximize the enjoyment of your new receiver:

Turning the AVR 120 On or Off

- When using the AVR 120 for the first time, you must press the **Main Power Switch 1** on the front panel to turn the unit on. This places the unit in a Standby mode, as indicated by the amber color of the **Power Indicator 3**. Once the unit is in Standby, you may begin a listening session by pressing the **System Power Control 2** on the front panel or the **AVR Selector 6**. Note that the **Power Indicator 3** will turn green. This will turn the unit on and return it to the input source that was last used. The unit may also be turned on from Standby by pressing any of the **Input Selector Buttons 5 6 7** on the remote or the **Input Source Selector 11** on the front panel.

NOTE: After pressing one of the **Input Selector Buttons 5 7** to turn the unit on, press the **AVR Selector 6** to set the remote control to the AVR 120's functions.

To turn the unit off at the end of a listening session, simply press the **System Power Control 2** on the front panel or the **Power Off Button 1** on the remote. Power will be shut off to any equipment plugged into the rear panel **Switched AC Outlet 15** and the **Power Indicator 3** will turn amber.

When the remote is used to turn the unit "off" it is actually placing the system in a Standby mode, as indicated by the amber color of the **Power Indicator 3**.

- To program the AVR 120 for automatic turn-off, press the **Sleep Button 9** on the remote. Each press of the button will decrease the time before shut down in the following sequence:

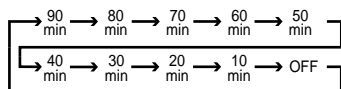

The sleep time will be displayed in the **Preset Number/Sleep Timer Indicator 11** and it will count down until the time has elapsed.

When the programmed sleep time has elapsed, the unit will automatically turn off. Note that the front panel display will dim to one half brightness when the Sleep function is programmed. To cancel the Sleep function, press and hold the **Sleep Button 9** until the information display returns to normal brightness, the Sleep indicator numbers disappear and the words **SLEEP OFF** appear in the **Main Information Display 12**.

When you will be away from home for an extended period of time it is always a good idea to completely turn the unit off with the front panel **Main Power Switch 1**.

NOTE: All preset memories are lost if the unit is left turned off by using the **Main Power Switch 1** for more than two weeks.

Source Selection

- To select a source, press any of the **Source Selector Buttons 5 7** on the remote.

- The input source may also be changed by pressing the front-panel **Input Source Selector 11**. Each press of the button will move the input selection through the list of available inputs.

- As the input is changed, the AVR 120 will automatically switch to the digital input (if selected), surround mode, speaker configuration, output levels and night mode status that were entered during the configuration process for that source.

- The front-panel **Video 4 Inputs 15 16** may be used to connect a device such as a video game or camcorder to your home entertainment system on a temporary basis.

- As the input source is changed, the new input name will momentarily appear in the **Main Information Display 12** and a green LED will light next to the selected input's name in the front panel **Input Indicators 22**.

- When an audio source is selected, the last video input used remains routed to the **Video 1 Output 19** and **Video Monitor Output 1**. This allows you to listen to an audio input such as the tuner while watching one of the video inputs.

- When a Video source is selected, the video signal for that input will be routed to the **Video Monitor Output Jack 1** and will be viewable on a TV monitor connected to the AVR 120.

Volume Control

- Adjust the volume to a comfortable level using the front-panel **Volume Control 20** or remote **Volume Up/Down 33** buttons.

- When listening in the Stereo mode with the surround circuits off, the **Balance Control 18** may be used to adjust the relative sound output between the front left and right speakers.

- To temporarily silence all speaker outputs press the **Mute Button 35**. This will interrupt the output to all speakers and the headphone jack, but it will not affect any recording or dubbing that may be in progress. Press the **Mute Button 35** again or adjust the volume to return to normal operation.

- During a listening session you may wish to adjust the **Bass Control 17** and **Treble Control 19** to suit your listening tastes or room acoustics.

- To set the output of the AVR 120 so that the output is "flat," with the tone controls deactivated, press the **Tone Mode Button 6** until the words **Tone Out** appear momentarily in the **Main Information Display 12**. To return the tone controls to an active condition, press the **Tone Mode Button 6** until the words **Tone In** momentarily appear in the **Main Information Display 12**.

- For private listening, plug the 1/4" stereo phone plug from a pair of stereo headphones into the front panel **Headphone Jack 4**. Note that when the headphone's plug is connected, the word **HEADPHONE** will scroll once across the **Main Information Display 12** and all speakers will be silenced. When the headphone plug is removed, the audio feed to the speakers will be restored.

Operation

Surround Mode Chart

MODE	FEATURES	DELAY TIME RANGE
DOLBY DIGITAL	Available only with digital input sources encoded with Dolby Digital data. It provides up to five separate main audio channels and a special dedicated Low-Frequency Effects channel.	Center: 0 ms – 5 ms Initial Setting – 0 ms Surround: 0 ms – 15 ms Initial Setting – 0 ms
DTS	Available only with digital input sources encoded with DTS data. Available on special DVD, LD and audio-only discs, DTS provides up to five separate main audio channels and a special dedicated low-frequency channel.	Delay time not adjustable
DOLBY PRO LOGIC II MOVIE MUSIC EMULATION	Dolby Pro Logic II is the latest version of Dolby Laboratory's benchmark surround technology that decodes full-range, discrete left, center, right, right surround and left surround channels from either matrix surround encoded programs or conventional stereo sources. The Dolby Pro Logic II Movie mode is optimized for movie soundtracks, while the Pro Logic II Music mode should be used with musical selections. The Pro Logic II Emulation mode creates compelling five-channel surround sound from conventional stereo recordings.	15 ms – 30 ms Initial Setting = 15 ms
LOGIC 7 C LOGIC 7 M	Logic 7 is an advanced mode that extracts the maximum surround information from either surround-encoded programs or conventional stereo material. The Logic 7 C or Cinema mode should be used with any source that contains Dolby Surround or similar matrix encoding. Logic 7 C delivers increased center-channel intelligibility, and more accurate placement of sounds with fades and pans that are much smoother and more realistic than with other decoding techniques. The Logic 7 M or Music mode should be used with analog or PCM stereo sources. Logic 7 M enhances the listening experience by presenting a wider front soundstage and greater rear ambience. Both Logic 7 modes also direct low-frequency information to the subwoofer (if installed and configured) to deliver maximum bass impact.	Delay time not adjustable
DOLBY 3 STEREO	Uses the information contained in a surround-encoded or two-channel stereo program to create center-channel information. In addition, the information that is normally sent to the rear-channel surround speakers is carefully mixed in with the front-left and front-right channels for increased realism. Use this mode when you have a center-channel speaker but no surround speakers.	No surround channels
THEATER	The THEATER mode creates a sound field that resembles the acoustic feeling of a standard live performance theater.	Delay time not adjustable
HALL 1 HALL 2	The two Hall modes create sound fields that resemble a small (HALL 1) or medium sized (HALL 2) concert hall.	Delay time not adjustable
VMAx Near VMAx Far	When only the two front-channel loudspeakers are used, Harman's patented VMAx mode delivers a three-dimensional sound space with the illusion of "phantom speakers" at the center and surround positions. The VMAx N, or "Near Field" mode should be selected when your listening position is less than five feet from the speakers. The VMAx F, or "Far Field" mode should be selected when your listening position is greater than five feet from the speakers. The VMAx modes are also available using the Headphones Output 4 . When headphones are being used, the Far Field mode will appear to push the sound field away from your ears, reducing the "inside the head" sensation often experienced when using headphones.	No surround channels
5-Channel Stereo	This mode takes advantage of multiple speakers to place a stereo signal at both the front and back of a room. Ideal for playing music in situations such as a party, it places the same signal at the front-left and surround-left, and front-right and surround-right speakers. The center channel is fed a summed mono mix of the in-phase material of the left and right channels.	No delay is available for this mode
SURROUND OFF (STEREO)	This mode turns off all surround processing and presents the pure left- and right-channel presentation of two-channel stereo programs.	No surround channels

Operation

Surround Mode Selection

One of the most important features of the AVR 120 is its ability to reproduce a full multichannel surround sound field from digital sources, analog matrix surround-encoded programs and standard stereo programs. In all, a total of fifteen listening modes are available on the AVR 120.

Selection of a surround mode is based on personal taste, as well as the type of program source material being used. For example, motion pictures or TV programs bearing the logo of one of the major surround-encoding processes, such as Dolby Surround, DTS Stereo or UltraStereo® may be played in either the Dolby Digital, Dolby Pro Logic II or Logic 7 Cinema surround modes depending on the source material.

NOTE: Once a program has been encoded with matrix surround information, it retains the surround information as long as the program is broadcast in stereo. Thus, movies with surround sound may be decoded via any of the analog surround modes such as Pro Logic II or Logic 7, when they are broadcast via conventional TV stations, cable, pay TV and satellite transmission. In addition, a growing number of made-for-television programs, sports broadcasts, radio dramas and music CDs are also recorded in surround sound. You may view a list of these programs at the Dolby Laboratories Web site at www.dolby.com.

Even when a program is not listed as carrying intentional surround information, you may find that the Pro Logic II, Logic 7, VMaX and the Hall or Theater modes often deliver enveloping surround presentations through the use of the natural information present in all stereo recordings. However, for stereo, but not surround programs, we suggest that you experiment with the other modes.

Surround modes are selected using either the front panel controls or the remote. To select a surround mode from the front panel, press the **Surround Mode Selector** **7** to scroll up or down through the list of available modes. To select a surround mode using the remote, press the **Surround Mode Selector** **10** and then press the **▲/▼ Buttons** **13** **17** to change the mode. As you press the buttons, the Surround mode name will appear in the **Main Information Display** **F**, and an individual mode indicator will also light up **BCDEG** **H I**. As the surround modes change, a green LED will light next to the current mode in the

Surround Mode Indicators **29** list on the front panel.

NOTE: The name of each **Surround Mode** will scroll across the **Main Information Display** **F** while the modes are being selected. To avoid exiting from the surround mode selection process, be certain to push the **▲** or **▼ Button** **13** **17** while a mode name is still visible.

Note that the Dolby Digital and DTS modes may only be selected when a digital input is in use. In addition, when a digital source is present, the AVR 120 will automatically select and switch to the correct mode (Dolby Digital or DTS), regardless of the mode that has been previously selected. For more information on selecting digital sources, see the following section of this manual.

To listen to a program in traditional two-channel stereo, using the front-left and front-right speakers only (plus the subwoofer if installed and configured), follow the instructions shown above for using the remote until **SURR OFF** appears in the **Main Information Display** **F**.

Digital Audio Playback

Digital audio is a major advancement over older analog matrix surround systems. It delivers five discrete channels: left-front, center, right-front, left-surround and right-surround. Each channel reproduces full frequency range (20Hz to 20kHz) and offers dramatically improved dynamic range and significant improvements to signal-to-noise ratios. In addition, digital systems have the capability to deliver an additional channel that is specifically devoted to low-frequency information. This is the ".1" channel referred to when you see these systems described as "5.1". The bass channel is separate from the other channels, but since it is intentionally bandwidth-limited, sound designers have given it that unique designation.

Dolby Digital

Dolby Digital (originally known as AC-3®) is a standard part of the DVD format, and is also part of the new digital broadcasting system and it is available with many satellite receivers and some digital cable boxes, as well as with specially encoded LD discs.

Note that an optional, external RF demodulator is required to use the AVR 120 to listen to the Dolby Digital sound tracks available on laser discs. Connect the RF output of the LD player to the demodulator and then connect the digital

output of the demodulator to the the **Optical** or **Coaxial Inputs** **23** **24** **13** **14** of the AVR 120. No demodulator is required for use with DVD players or DTS-encoded laser discs.

DTS

DTS is another digital audio system that is capable of delivering 5.1 audio. Although both DTS and Dolby Digital are digital, they use different methods of encoding the signals, and thus they require different decoding circuits to convert the digital signals back to analog.

DTS-encoded sound tracks are available on select DVD and LD discs, as well as on special audio-only DTS discs. You may use any LD or CD player equipped with a digital output to play DTS-encoded discs with the AVR 120. All that is required is to connect the player's output to either the **Optical** or **Coaxial** input on the rear panel **23** **24** or front panel **13** **14**.

In order to listen to DVDs encoded with DTS sound tracks, the DVD player must be compatible with the DTS signal as indicated by a DTS logo on the player's front panel. Note that early DVD players may not be able to play DTS-encoded DVDs. This does not indicate a problem with the AVR 120, as some players cannot pass the DTS signal through to the digital outputs. If you are in doubt as to the capability of your DVD player to handle DTS discs, consult the player's owner's manual. Please note that some DVD players are shipped with their output set for Dolby Digital only. To insure that DTS data is being sent to the AVR, please check the setup menu system on your DVD player to make certain that DTS data output is enabled.

Selecting a Digital Source

To utilize either digital mode you must have properly connected a digital source to the AVR 120. Connect the digital outputs from DVD players, HDTV receivers, satellite systems or CD players to the **Optical** or **Coaxial Inputs** **23** **24** **13** **14**. In order to provide a backup signal and a source for analog stereo recording, the analog outputs provided on digital source equipment should also be connected to their appropriate inputs on the AVR 120 rear panel (e.g., connect the analog stereo audio output from a DVD to the **DVD Audio Inputs** **6** on the rear panel when you connect the source's digital outputs).

When playing a digital source such as DVD, first select the input using the remote or front panel

Operation

controls as outlined in this manual. Next, select the digital source by pressing the **Digital Input Selector Button** **16** **24** and then using the **▲/▼ Buttons** **13** **17** on the remote or the **Selector Buttons** **5** on the front panel to choose any of the **OPTICAL** or **COAXIAL** inputs, as they appear in the **Main Information Display** **6**, the **Digital Input Indicators** **17** **18**. When the digital source is playing, the AVR 120 will automatically detect whether it is a multichannel Dolby Digital or DTS source, an MP3 signal or a conventional PCM signal, which is the standard output from CD players. A **Bitstream Indicator** **19** will light in the **Main Information Display** **25** to confirm that the digital signal is Dolby Digital, DTS, PCM or MP3.

Digital Status Indicators

When a digital source is playing, the AVR 120 senses the type of bitstream data that is present. Using this information, the correct surround mode will automatically be selected. For example, DTS bitstreams will cause the unit to switch to DTS decoding, and Dolby Digital bitstreams will enable Dolby Digital decoding. When the unit senses PCM data from CDs or LDs, you may select any of the standard surround modes, such as Dolby Pro Logic II or Logic 7. Since the range of available surround modes is dependent on the type of digital data that is present, the AVR 120 uses a variety of indicators to let you know what type of signal is present. This will help you to understand the choice of modes.

When a digital source is playing, a **Bitstream Indicator** **19** will light to show which type of signal is playing:

DD: When the DOLBY D indicator lights, a Dolby Digital bitstream is being received. Depending on the settings on the source player and specific surround information and number of channels on the disc, a number of surround modes are possible. For discs with full 5.1 audio, only the Dolby Digital and VMAx modes are available. When the Dolby Digital signal is only two-channel, you may also select from the Logic 7 Cinema/Music, Hall 1/2, Theater, Dolby Pro Logic II Movie, Music or Emulation, or Dolby 3 Stereo Modes. When the AVR 120 senses a 2.0-channel Dolby Digital signal, the unit will automatically select Dolby Pro Logic II as the surround processing mode, and both the **Dolby Digital** **19** and **Dolby Pro Logic II** **20** indicators will light in accordance with the requirements of Dolby Laboratories.

DTS: When the DTS indicator lights, a DTS bitstream is being received. When the unit senses this type of data, only the DTS mode may be used.

PCM: When the PCM indicator lights, a standard Pulse Code Modulation, or PCM, signal is being received. This is the type of digital audio used by conventional compact disc and laser disc recordings. When a PCM bitstream is present, all modes except Dolby Digital and DTS are available.

MP3: When the MP3 indicator lights, a compatible MPEG 1/Layer 3 digital signal is being received. This is the popular audio format used by many computer programs for recording compressed audio files. When an MP3 bitstream is present, the sound will automatically be played in the stereo (surround off) mode. The surround modes are not available during MP3 playback.

In addition to the bitstream indicators, the AVR 120 features a set of unique channel-input indicators that tell you how many channels of digital information are being received and/or whether the digital signal is interrupted.

These indicators are the L/C/R/SL/SR/LFE letters that are inside the center boxes of the **Speaker/Channel Input Indicators** **14** in the front panel **Main Information Display** **25**. When a standard analog signal is in use, only the "L" and "R" indicators will light, as analog signals have only left and right channels, respectively.

Digital signals, however, may have two, five or six separate channels, depending on the program material, the method of transmission and the way in which it was encoded. When a digital signal is playing, the letters in these indicators will light in response to the specific signal being received. It is important to note that although Dolby Digital, for example, is referred to as a "5.1" system, not all Dolby Digital DVDs or programs are encoded with 5.1 channels. Thus, it is sometimes normal for a DVD with a Dolby Digital soundtrack to trigger only the "L" and "R" indicators.

NOTE: Many DVD discs are recorded with both "5.1" and "2.0" versions of the same soundtrack. When playing a DVD, always be certain to check the type of material on the disc. Most discs show this information in the form of a listing or icon on the back of the disc jacket. When a disc does offer multiple sound track choices you may have to make some adjust-

ments to your DVD player (usually with the "Audio Select" button or in a menu screen on the disc) to send a full 5.1 feed to the AVR 120. It is also possible for the type of signal feed to change during the course of a DVD playback. In some cases the previews of special material will only be recorded in 2.0 audio, while the main feature is available in 5.1 audio. As long as your DVD player is set for 6-channel output, the AVR 120 will automatically sense changes to the bitstream and channel count and reflect them in these indicators.

The letters used by the **Speaker/Channel Input Indicators** **14** also flash to indicate when a bitstream has been interrupted. This will happen when a digital input source is selected before the playback starts, or when a digital source such as a DVD is paused. The flashing indicators remind you that the playback has stopped due to the absence of a digital signal and not through any fault of the AVR 120. This is normal, and the digital playback will resume once the playback is started again.

Night Mode

A special feature of Dolby Digital is the Night mode, which enables Dolby Digital input sources to be played back with full dialogue intelligibility while reducing the minimum peak level by $1/4$ to $1/3$. This prevents abruptly loud transitions from disturbing others, without reducing the impact of the digital source. The Night mode is available only when Dolby Digital signals with special data are being played.

The Night mode may be engaged when a Dolby Digital DVD is playing by pressing the **Night Mode Button** **11** on the remote. Next, press the **▲/▼ Buttons** **13** **17** to select either the middle range or full-compression versions of the Night mode. To turn the Night mode off, press the **▲/▼ Buttons** **13** **17** until the message in the **Main Information Display** **6** reads **D - Range Off**. When the Night mode is active, the **Night Mode Indicator** **21** will also light.

IMPORTANT NOTES ON DIGITAL PLAYBACK:

1. When the digital playback source is stopped, or in a Pause, Fast Forward or Chapter Search mode, the digital audio data will momentarily stop, and the channel position letters inside the **Speaker/Channel Input Indicators** **14** will flash. This is normal and does not indicate a problem with either the AVR 120 or the source machine. The AVR

Operation

120 will return to digital playback as soon as the data is available and when the machine is in a standard play mode.

2. Although the AVR 120 will decode virtually all DVD movies, CDs and HDTV sources, it is possible that some future digital sources may not be compatible with the AVR 120.
3. Note that not all digitally encoded programs contain full 5.1-channel audio. Consult the program guide that accompanies the DVD or laser disc to determine which type of audio has been recorded on the disc. The AVR 120 will automatically sense the type of digital surround encoding used and adjust to accommodate it.
4. When a digital source is playing, you may not be able to select some of the analog surround modes such as Dolby Pro Logic II, Dolby 3 Stereo, Hall, Theater or Logic 7.
5. When a Dolby Digital or DTS source is playing, it is not possible to make an analog recording using the **Tape 2** and **Video 1 Audio Outputs 5**. However, the digital signals will be passed through to the **Optical 9** and **Coaxial 10 Digital Audio Outputs**.

PCM Audio Playback

PCM (Pulse Code Modulation) is the non-compressed digital audio system used for compact discs and laser discs. The digital circuits in the AVR 120 are capable of high-quality digital-to-analog decoding, and they may be connected directly to the digital audio output of your CD or LD player.

Connections may be made to either the rear panel **Optical** or **Coaxial Inputs 23/24** or the front panel **Optical** or **Coaxial Digital Inputs 13/14**.

To listen to a PCM digital source, first select the input for the desired source (e.g., CD). Next, press the **Digital Input Selector 24/16** and then use the **▲/▼ Buttons 13/17** on the remote, or the **Selector Buttons 5** on the front panel, until the desired choice appears in the **Main Information Display F**.

When a PCM source is playing, the **PCM Indicator A** will light. During PCM playback, you may select any surround mode except Dolby Digital or DTS.

Playback from PCM sources may also benefit from the Logic 7 Mode. When playing back a surround-encoded PCM source, such as an LD or surround-encoded CD, use the Logic 7 C or Cinema mode. When playing true stereo recordings, use the Logic 7 M or Music mode for a wider soundstage and increased rear-channel ambience.

NOTE: When a Logic 7 mode is in use with a digital input source which has another mode for its default, that default mode, rather than Logic 7, will be used by the AVR after the digital bitstream is interrupted for any reason such as stopping or pausing the digital playback. Note, also, that Logic 7 is not available with digital playback unless a two-channel bitstream is in use.

MP3 Audio Playback

The AVR 120 is one of the few A/V receivers to provide on-board decoding for the MP3 audio format used by computers and portable audio devices. In addition, some new CD players are capable of playing back optical discs that are recorded with MP3, rather than standard CD audio information. By offering MP3 decoding, the AVR 120 is able to deliver more precise conversion of the digital signals to an analog output, along with the benefits of listening to the MP3 audio through the AVR 120's high-current amplifier and the speakers from your surround system, rather than the smaller speakers and low-powered amplifiers typically used with computers.

To take advantage of the AVR 120's MP3 capabilities, simply connect the PCM output of a computer's sound card or the PCM output of a portable digital audio device to either the rear panel **Digital Inputs 23/24** or the front panel **Digital Inputs 13/14**. As soon as the digital signal is available, the **MP3 Bitstream Indicator A** will light, and the audio will begin playing.

NOTES:

- The AVR 120 only plays signals in the MP3 (MPEG 1/Layer 3) format. It is not compatible with other computer audio codecs.
- The digital audio input signal may be either optical or coaxial, but it must be PCM in the S/P-DIF format. Direct connection of USB or serial data outputs is not possible, even if the signals are in the MP3 format. If you have any questions about the data output format from your computer or a sound card, check with the device's owner's manual or contact its manufacturer.

Tuner Operation

The AVR 120's tuner is capable of tuning AM, FM and FM Stereo broadcast stations. Stations may be tuned manually, or they may be stored as favorite station presets and recalled from a 30-position memory.

Station Selection

1. Press the **AM/FM Tuner Select Button 7** on the remote to select the tuner as an input. The tuner may be selected from the front panel by either pressing the **Input Source Selector 11** until the tuner is active or by pressing the **Tuner Band Selector 9**.
2. Press the **AM/FM Tuner Select Button 7** or **Tuner Band Selector 9** again to switch between AM and FM so that the desired frequency band is selected.
3. Press the **FM Mode Button 12/19** to select manual or automatic tuning.

When the **AUTO Indicator R** is illuminated in the **Main Information Display 25** the tuner will stop only at those stations that have a strong enough signal to be received with acceptable quality.

When the **AUTO Indicator R** is not illuminated, the tuner is in a manual mode and will stop at each frequency increment in the selected band.

4. To select stations, press the **Tuning Selector Button 8/21**. When the **AUTO Indicator R** is illuminated, press the button for two seconds and then release to cause the tuner to search for the next highest- or lowest-frequency station that has an acceptable signal. When tuning FM stations in the Auto mode, the tuner will select only stereo stations. To tune to the next station, press the button again. If the **STEREO Indicator P** is not illuminated, tap the **Tuning Selector Button 8/21** to advance one frequency increment at a time, or press and hold it to locate a specific station. When the **TUNED Indicator Q** lights, the station is properly tuned and should be heard with clarity.
5. Stations may also be tuned directly by pressing the **Direct Button 20**, and then press-

Operation

ing the **Numeric Keys** **18** that correspond to the station's frequency. The desired station will automatically be tuned. If you press an incorrect button while entering a direct frequency, press the **Clear Button** **27** to start over.

NOTE: When the FM reception of a station is weak, audio quality will be increased by switching to Mono mode by pressing the **FM Mode Button** **12** **19** until the **STEREO** **Indicator** **P** goes out.

Preset Tuning

Using the remote, up to 30 stations may be stored in the AVR 120's memory for easy recall using the front panel controls or the remote.

To enter a station into the memory, first tune the station using the steps outlined above. Then:

1. Press the **Memory Button** **23** on the remote. Note that the **MEMORY Indicator** **Q** will be illuminated and flash in the **Main Information Display** **25**.
2. Within five seconds, press the **Numeric Keys** **18** corresponding to the location where you wish to store this station's frequency. Once entered, the preset number will appear in the **Preset Number/Sleep Time Display** **U**.
3. Repeat the process after tuning any additional stations to be preset.

Recalling Preset Stations

- To manually select a station previously entered in the preset memory, press the **Numeric Keys** **18** that correspond to the desired station's memory location.
- To manually tune through the list of stored preset stations one by one, press the **Preset Stations Selector Buttons** **10** **25** on the front panel or remote.

Tape Recording

In normal operation, the audio or video source selected for listening through the AVR 120 is sent to the record outputs. This means that any program you are watching or listening to may be recorded simply by placing machines connected to the outputs for **Tape Outputs** **2** or **Video 1 Outputs** **5** **19** in the Record mode.

When a digital audio recorder is connected to the **Optical** **9** or **Coaxial** **10** **Digital Audio Outputs**, you are able to record the digital signal using a CD-R, MiniDisc or other digital recording system.

NOTES:

- The digital outputs are active only when a digital signal is present, and they do not convert an analog input to a digital signal, or change the format of the digital signal. In addition, the digital recorder must be compatible with the output signal. For example, the PCM digital input from a CD player may be recorded on a CD-R or MiniDisc, but Dolby Digital or DTS signals may not.
- Please make certain that you are aware of any copyright restrictions on any material you copy. Unauthorized duplication of copyrighted materials is prohibited by federal law.

Output Level Trim Adjustment

Normal output level adjustment for the AVR 120 is established using the test tone, as outlined on pages 18 and 19. In some cases, however, it may be desirable to adjust the output levels using program material such as a test disc, or a selection you are familiar with. Additionally, the output level for the subwoofer can only be adjusted using this procedure.

To adjust the output levels using program material, first set the reference volume for the front-left and front-right channels using the **Volume Control** **20** **33**.

Once the reference level has been set, press the **Channel Select Button** **12** **26** and note that **FRONT L LEV** will appear in the **Main Information Display** **F**. To change the level, first press the **Set Button** **15** **21**, and then use the **Selector Buttons** **5** or the **▲/▼ Buttons** **13** **17** to raise or lower the level. DO NOT use the volume control, as this will alter the reference setting.

Once the change has been made, press the **Set Button** **15** **21** and then press the **Selector Buttons** **5** or the **▲/▼ Buttons** **13** **17** to select the next output channel location that you wish to adjust. To adjust the subwoofer level, press the **Selector Buttons** **5** or the **▲/▼ Buttons** **13** **17** until **WOOFER LEV** appears in the **Main Information Display** **F**.

Press the **Set Button** **15** **21** when the name of the desired channel appears in the **Main Information Display** **F**, and follow the instructions shown earlier to adjust the level.

Repeat the procedure as needed until all channels requiring adjustment have been set. When all adjustments have been made and no further adjustments are made for five seconds, the AVR 120 will return to normal operation.

NOTE: The output levels may be separately trimmed for each digital and analog surround mode. If you wish to have different trim levels for a specific mode, select that mode and then follow the instructions in the steps shown earlier.

Display Brightness

The AVR 120's **Main Information Display** **25** is set at a default brightness that is sufficient for viewing in a normally lit room. However, in some home theater installations, you may wish to occasionally lower the brightness of the display or turn it off completely.

To change the display brightness, press and hold the **Set Button** **21** on the front panel for three seconds until the message in the **Main Information Display** **F** reads **VF D FULL**. Within five seconds, press the **Selector Buttons** **5** on the front panel until the desired display brightness level is shown. At that point, press the **Set Button** **21** again to enter the setting.

When **FULL** appears in the **Main Information Display** **F**, the display is at its normal brightness. When **HALF** appears, the display is at half the normal brightness level. When **OFF** appears, all of the indicators in the **Main Information Display** **F** will go dark. Note, however, that the green LEDs for the **Input Indicators** **22** and the **Surround Mode Indicators** **29**, as well as the **Power Indicator** **3** will always remain lit to remind you that the AVR 120 is still turned on.

Once the desired brightness level is selected, it will remain in effect until it is changed again or until the unit is turned off.

Programming the Remote

The AVR 120 is equipped with a powerful remote control that will control not only the receiver's functions, but also most popular brands of audio and video equipment, including CD players, cassette decks, TV sets, cable boxes, VCRs, satellite receivers and other home theater equipment. Once the AVR 120's remote is programmed with the codes for the products you own, it is possible to eliminate most other remotes and replace them with the convenience of a single, universal remote control.

Programming the Remote

As shipped from the factory, the remote is fully programmed for all AVR 120 functions, as well as those of most Harman Kardon CD changers, DVD players, CD recorders, CD players and cassette decks. In addition, by following one of the methods below, you may program the remote to operate a wide range of devices from other manufacturers.

Direct Code Entry

This method is the easiest way to program your remote to work with different products.

1. Use the tables in the following pages to determine the three-digit code or codes that match both the product type (e.g., VCR, TV), and the specific brand name. If there is more than one number for a brand, make note of the different choices.
2. Turn on the unit you wish to program into the AVR 120 remote.
3. Press and hold both the **Input Selector** **5** for the product you wish to control (e.g., VCR, TV) and the **Mute Button** **35** at the same time. When the **Program Indicator** **3** turns amber and begins flashing, release the buttons. It is important that you begin the next step within 20 seconds.
4. Point the AVR 120's remote towards the unit to be programmed and enter the first three-digit code number using the **Numeric Keys** **18**. If the unit turns off, the correct code has been entered. Press the **Input Selector** **5** again, and note that the red light will flash three times before going dark to confirm the entry.
5. If the device to be programmed in does NOT turn off, continue to enter three-digit code numbers until the equipment turns off. At this point, the correct code has been entered. Press the **Input Selector** **5**

again and note that the red light under the **Input Selector** **5** will flash three times before going dark to confirm the entry.

6. Try all of the functions on the remote to make certain that the product operates properly. Keep in mind that many manufacturers use a number of different combinations of codes, so it is a good idea to make certain that not only the power control, but the volume, channel and transport controls work as they should. If functions do not work properly, you may need to use a different remote code.
7. If a code cannot be entered to turn the unit off, if the code for your product does not appear in the tables in this manual, or if not all functions operate properly, try programming the remote with the Auto Search Method.

Auto Search Method

If the unit you wish to include in the AVR 120's remote is not listed in the code tables in this manual or if the code does not seem to operate properly, you may wish to program the correct code using the Auto Search method that follows:

1. Turn on the unit that you wish to include in the AVR 120 remote.
2. Press the **Input Selector** **5** for the type of product to be entered (e.g., VCR, TV) and the **Mute Button** **35** at the same time. Hold both buttons until the red light under the **Input Selector** **5** stays lit. Note that the next step must take place while the red light is on, and it must begin within 20 seconds after the light appears.
3. Point the AVR 120 remote towards the unit to be programmed and press either the **▲** or **▼** **Button** **13** **17**. Each press will send out a series of codes from the remote's built-in database. When the unit being programmed turns off, release the **▲** or **▼** **Button** **13** **17**, as that is your indication that the correct code is in use.
4. Press the **Input Selector** **5**, and note that the red light under the Input Selector will flash three times before going dark to confirm the entry.
5. Try all of the functions on the remote to make certain that the product operates. Keep in mind that many manufacturers use a number of different combinations of codes, and it is a good idea to make certain

that not only the power control works, but also that the volume, channel and transport controls function properly. If all functions do not work properly, you may need to Auto-Search for a different code, or enter a code via the Direct Code Entry method.

Code Readout

When the code has been entered using the Auto Search method, it is always a good idea to find out the exact code so that it may be easily reentered if necessary. You may also read the codes to verify which device has been programmed to a specific Control Selector button.

1. Press and hold both the **Input Selector** **5** for the device for which you wish to find the code and the **Mute Button** **35** at the same time. Note that the **Program Indicator** **3** will initially turn amber. Release the buttons and begin the next step within 20 seconds.
2. Press the **Set Button** **15**. The **Program Indicator** **3** will then blink green in a sequence that corresponds to the three-digit code, with a one-second pause between digits. Count the number of blinks between pauses to determine the digit of the code. One blink is the number 1, two blinks is the number 2, and so forth. Ten blinks are used to indicate a "0."

Example: One blink, followed by a one-second pause, followed by six blinks, followed by a one-second pause, followed by ten blinks indicates that the code has been set to 160.

For future reference, enter the Setup Codes for the equipment in your system here:

DVD _____ CD _____
VID1/VCR _____ VID2/TV _____
VID3/CBL/SAT _____
VID4 _____ TAPE _____

Programming the Remote

Macro Programming

Macros enable you to easily repeat frequently used combinations of commands with the press of a single button on the AVR 120 remote control. Once programmed, a macro will send out up to 19 different remote codes in a predetermined sequential order, enabling you to automate the process of turning on your system, changing devices, or other common tasks. The AVR 120 remote can store up to five separate macro command sequences: one that is associated with the **Power On Button 4**, and four more that are accessed by pressing the **Macro Buttons 22**.

1. Press the **Mute Button 35** and the **Macro Button 22** to be programmed or the **Power On Button 4** at the same time. Note that the last **Input Selector 5** pressed will light red, and the **Program Indicator 3** will flash amber.
2. Enter the steps for the macro sequence by pressing the button for the actual command step. Although the macro may contain up to 19 steps, each button press, including those used to change devices, counts as a step. The **Program Indicator 3** will flash green to confirm each button press as you enter commands.

NOTE: While entering commands for Power On/Off of any device during a macro sequence, press the **Mute Button 35**. DO NOT press the actual Power Button.

3. When all the steps have been entered, press the **Sleep Button 9** to enter the commands. The red light under the **Input Selectors 5 6** will blink and then turn off.

Example: To program the **Macro 1 Button 22** so that it turns on the AVR 120, TV and a Cable Box, follow these steps:

- Press the **Macro 1 22** and **Mute 35** buttons at the same time and then release them.
- Note that the **Program Indicator 3** will flash amber.
- Press the **AVR Selector 6**.
- Press the **Mute Button 35** to store the AVR 120's Power On command.
- Press the **VID2 Input Selector Button 5** to indicate the next command is to be transmitted to the TV.
- Press the **Mute Button 35** to store the TV Power On Command.

- Press the **VID3 Input Selector Button 5** to indicate the next command is to be transmitted to the cable box.
- Press the **Mute Button 35** to store the Cable Power On command.
- Press the **Sleep Button 9** to complete the process and store the macro sequence.

After following these steps, each time you press the **Macro 1 Button 22**, the remote will send the Power On/Off command to the AVR 120, the television and the cable box with a single button press.

Erasing Macro Commands

To erase the commands that have been programmed into one of the Macro buttons, follow these steps:

1. Press the **Mute Button 35** and the **Macro Button 22** that contains the commands you wish to erase.
2. Note that the **Program Indicator 3** will flash amber, and the LED under the **AVR Selector 6** will turn red.
3. Within ten seconds, press the **Surround Mode Selector/Channel Down Button 10**.
4. The red LED under the **AVR Selector 6** will go out, and the **Program Indicator 3** will turn green and flash three times before it goes out.
5. When the **Program Indicator 3** goes out, the Macro has been erased.

Programmed Device Functions

Once the AVR 120's remote has been programmed for the codes of other devices, press the appropriate **Input Selector 5** to change the remote from controlling the AVR 120 to controlling the additional product. When you press any one of the selectors, it will briefly flash in red to indicate that you have changed the device being controlled.

When operating a device other than the AVR 120, the controls may not correspond exactly to the function printed on the remote or button. Some commands, such as the Volume Control, are the same as they are with the AVR 120. Other buttons will change their function so that they correspond to a secondary label on the remote. For example, the Sleep and Surround mode selector buttons also function as the Channel Up and Channel Down

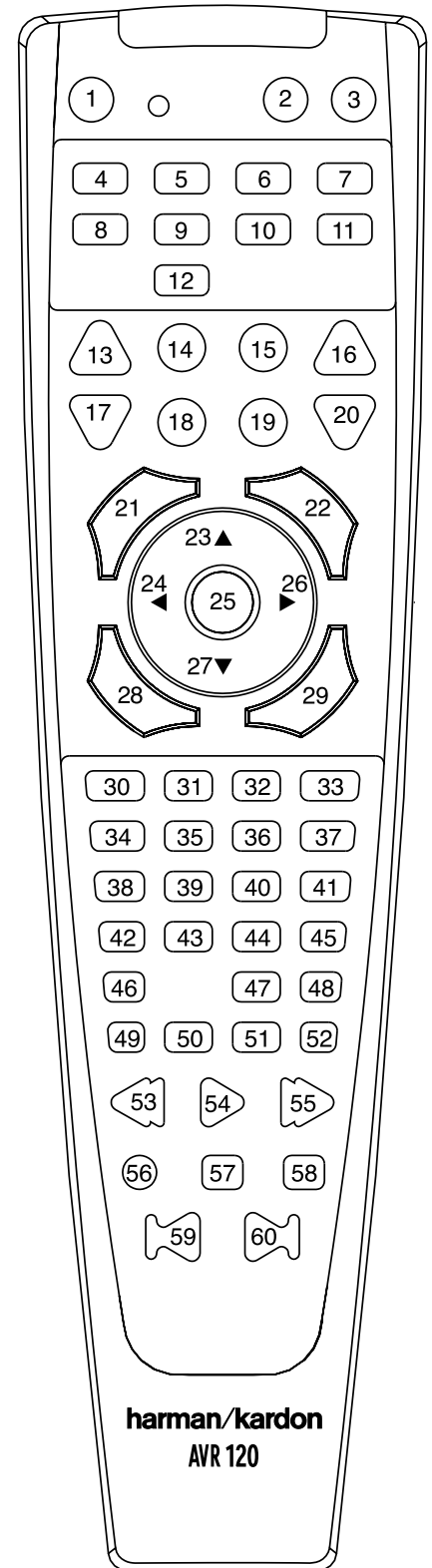

The diagram above shows the button numbers used in the Function List on pages 31 and 32.

Programming the Remote

buttons when operating most TV sets, VCRs or cable boxes. The Channel Up/Down indication is printed directly on the remote. For many standard CD players, cassette decks, VCRs and DVD functions, the standard function icons are printed on top of the buttons.

For some products, however, the function of a particular button does not follow the command printed on the remote. In order to see which function a button controls, consult the Function List tables on pages 31 and 32. To use those tables, first check the type of device being controlled (e.g., TV, VCR). Next, look at the remote control diagram pictured at the left. Note that each button has a number on it.

To find out what function a particular button has for a specific device, find the button number on the Function List and then look in the column for the device you are controlling. For example, button number 50 is the Macro 1 button for the AVR 120, but it is the "Favorite" button for many cable television boxes and satellite receivers. Button number 29 is the Delay button for the AVR 120, but the Open/Close button for CD players.

NOTE: The numbers used to describe the button functions in the diagram on page 28 for the purposes of describing how a button operates are a different set of numbers than those used in the rest of this manual to describe the button functions for the AVR 120.

Notes on Using the AVR 120 Remote With Other Devices.

- Manufacturers may use different code sets within the same product category, such as TV sets or VCRs. They may also change codes for a certain category from one model year to the next. For that reason, it is important that you check to see whether the code set you have entered operates as many controls as possible. If it appears that only a few functions operate, check to see whether another code set will work with more buttons.
- When a button is pressed on the AVR 120 remote, the red light under the **Input Selector** 5 for the product being operated should flash briefly. If the Device Control Selector flashes for some but not all buttons for a particular product, it does NOT indicate a problem with the remote but rather that no function is programmed for the button being pushed.

Punch-Through Programming

The AVR 120's remote may be programmed to control one device, such as a TV, while simultaneously directing only certain functions to another device, such as the transport controls of a DVD player, without having to switch back and forth between inputs. You may also use the remote to control the system volume on the AVR without the need to switch between different devices. This is called "Punch-Through," and this section will show you how to program the remote for these functions.

NOTE: All programming for the remote codes needed to operate specific devices, such as a TV, DVD, cable box, satellite receiver or VCR, should be completed before programming punch-through commands.

Volume Punch-Through

The AVR 120's remote may be programmed to operate the **Volume Control** 33 and **Mute** 35 functions of either the TV or the AVR 120 in conjunction with any of the devices controlled by the remote. For example, since the AVR 120 will likely be used as the sound system for TV viewing, you may wish to have the AVR 120's volume activated, although the remote is set to run the TV. Either the AVR 120 or TV volume control may be associated with any of the remote's devices. To program the remote for Volume Punch-Through, follow these steps:

- Press the **Input Selector** 5 for the unit you will be using (e.g., TV) when you wish to have Volume Punch-Through to your audio system active and the **Mute** 35 at the same time until the red light appears under the **Input Selector** 5 and note that the **Program Indicator** 3 will flash amber.
- Press the **Volume Up Button** 33 and note that the **Program Indicator** 3 will stop flashing and stay amber.
- Press either the **AVR Selector** 6 or the **Input Selector** 5, depending on which system's volume control you wish to have attached for the punch-through mode. The **Program Indicator** 3 will blink green three times and then go out to confirm the data entry.

Example: To have the AVR 220's volume control activated even though the remote is set to control the TV, first press the **Video/TV Input Selector** 5 and the **Mute Button** 35 at the same time. Next, press the **Volume Up Button** 33, followed by the **AVR Input Selector** 6.

NOTE: Should you wish to return the remote to the original configuration after entering a Volume Punch-Through, you will need to repeat the steps shown above. However, press the same Input Selector in Steps 1 and 3.

Channel Control Punch-Through

The AVR 120's remote may be programmed to operate so that the channel control function for either the TV, cable or satellite receiver used in your system may be used in conjunction with one of the other devices controlled by the remote. For example, while using and controlling the VCR, you may wish to change channels on a cable box or satellite receiver without having to change the device selected by the AVR 120 or the remote. To program the remote for Channel Control Punch-Through, follow these steps:

- Press the **Input Selector Button** 5 for the device you will be using (e.g., VCR) when you wish to have Channel Punch-Through active and the **Mute Button** 35 at the same time until the red light appears under the **Input Selector** 5 and the **Program Indicator** 3 flashes amber.
- Press the **Volume Down Button** 33. The **Program Indicator** 3 will stop flashing and stay amber.
- Press and release the **Input Selector Button** 5 for the device that will be used to change the channels. The **Program Indicator** 3 will blink green three times and then go out to confirm the data entry.

Example: To control the channels using your Cable Box or Satellite Receiver while the remote is set to control the VCR, first press the **VID1/VCR Input Selector Button** 5 and the **Mute Button** 35 at the same time. Next, release them and press the **Volume Down Button** 33, followed by the **VID2/TV Input Selector Button** 5.

Programming the Remote

NOTE: To remove the Channel Control Punch-Through and return the remote to its original configuration, repeat the steps shown above. However, press the same button in Steps 1 and 3.

Transport Control Punch-Through

The AVR 120's remote may be programmed to operate so that the **Transport Control Functions** (Play, Stop, Fast Forward, Rewind, Pause and Record) for a VCR, cassette deck, DVD or CD will operate in conjunction with one of the other devices controlled by the remote. For example, while using and controlling the TV, you may wish to start or stop your VCR or DVD without having to change the device selected by the AVR 120 or the remote. To program the remote for Transport Control Punch-Through, follow these steps:

1. Press the **Input Selector** (5) for the device you will be using (e.g., TV) when you wish to have Transport Control Punch-Through active and the **Mute Button** (35) at the same time until the red light appears under the **Input Selector** (5) and the **Program Indicator** (3) flashes amber.
2. Press the **Play Button** (23). The **Program Indicator** (3) will stop flashing and stay amber.
3. Press and release the **Input Selector Button** (5) for the device whose transport mechanism will be controlled (e.g., DVD, CD). The **Program Indicator** (3) will blink green three times and then go out to confirm the data entry.

Example: To control the transport of a DVD player while the remote is set to control the TV, first press the **VID2/TV Input Selector Button** (5) and the **Mute Button** (35) at the same time. Next, release them and press the **Play Button** (23), followed by the **DVD Input Selector Button** (5).

NOTE: To remove the Channel Control Punch-Through and return the remote to its original configuration, repeat the steps shown above. However, press the same button in Steps 1 and 3.

Reassigning Device Control Selectors

Although each **Input Selector** (5) is normally assigned to the category of product shown on the remote, it is possible to reassign one of these buttons to operate a second device of another type. For example, if you have two VCRs but no satellite receiver, you may program the "SAT" button to operate a second VCR. Before following the normal programming steps for either Three-Digit entry or Auto Search code entry, you must first reassign the button with the following steps:

1. Press the **Input Selector** (5) you wish to reassign and the **Mute Button** (35) at the same time until the red light appears under the **Input Selector** (5) and the **Program Indicator** (3) flashes amber.
2. Press the **Input Selector** (5) for the device type you wish to program into the reassigned button.
3. Enter the three-digit code for the specific model you wish the reassigned button to operate.
4. Press the same **Input Selector** (5) pressed in Step 1 once again to store the selection. The red LED under the reassigned Input Selector will flash three times and then go out.

Example: To use the CBL/SAT button to operate a second VCR, first press the **CBL/SAT Input Selector** (5) and the **Mute Button** (35) at the same time until the red light glows under the **CBL/SAT Button** (5). Press the **VCR Button** (5), followed by the three-digit code for the specific model you wish to control. Finally, press the **CBL/SAT Button** (5) again.

Resetting the Remote Memory

As you add components to your home theater system, occasionally you may wish to totally reprogram the remote control without the confusion of any commands, macros or "Punch-Through" programming that you may have done. To do this, it is possible to reset the remote to the original factory defaults and command codes by following these steps. Note, however, that once the remote is reset, all commands or codes that you have entered will be erased and will need to be reentered:

1. Press any of the **Input Selector Buttons** (5) and the **"0" Button** (18) at the same time until the **Program Indicator** (3) begins to flash amber.
2. Press the **"3" Button** (18) three times.
3. The red LED under the **Input Selector** (5) will go out and the **Program Indicator** (3) will stop flashing and turn green.
4. The **Program Indicator** (3) will remain green until the remote is reset. Note that this may take a while, depending on how many commands are in the memory and need to be erased.
5. When the **Program Indicator** (3) goes out, the remote has been reset to the factory settings.

Function List

No.	Button Name	AVR Function	DVD	CD/CD-R	Tape	VCR (VID1)	TV (VID1)	CBL (VID3)	SAT (VID3)
1	Power Off	Power Off	Power Off	Power Off	Power Off	Power Off	Power Off	Power Off	Power Off
2	Power On	Power On	Power On	Power On	Power On	Power On	Power On	Power On	Power On
3	Mute	Mute	Mute	Mute	Mute	Mute	Mute	Mute	Mute
4	AVR	AVR Select							
5	DVD	DVD Input Select	DVD Select						
6	CD	CD Input Select		CD Select					
7	Tape	Tape Input Select			Tape Select				
8	VID1	Video 1 Select				VCR Select			
9	VID2	Video 2 Select					TV Select		
10	VID3	Video 3 Select						VID3 Select	
11	VID4	Video 4 Select							
12	AM/FM	Tuner Select							
13	Sleep	Sleep					Channel +	Channel +	Channel +
14	Test	Test Tone		Input Select					
15	TV		TV/DVD	CDP Select		TV/VCR	TV/VCR	TV/Cable	TV/Sat
16	Volume Up	Volume Up		Input Level Up		Volume Up	Volume Up	Volume Up	Volume Up
17	Surround Select	Surround Mode Select		CDR Select		Channel –		Channel –	Channel –
18	Night	Night Mode Select							
19	Spare								
20	Volume Down	Volume Down		Input Level Down			Volume Down	Volume Down	Volume Down
21	Channel/Guide	Channel Trim	Title					Info/Guide	Info/Guide
22	Speaker/Menu	Speaker Adjust	Menu			Menu	Menu	Menu	Menu
23	▲	Move/Adjust Up	Up			Up	Up	Up	Up
24	◀	Move/Adjust Left	Left			Left	Left	Left	Left
25	Set	Set	Enter			Enter	Enter	Enter	Enter
26	▶		Right			Right	Right	Right	Right
27	▼	Move/Adjust Down	Down			Down	Down	Down	Down
28	Digital/Exit	Digital Input Select	Subtitle			Exit	Exit	Exit	Exit
29	Delay/Prev. Ch.	Delay Adjust	Return	Time			Prev Channel	Prev Channel	Prev Channel
30	1		1	1		1	1	1	1
31	2		2	2		2	2	2	2
32	3 ◀◀		3	3		3	3	3	3
33	4 ▶▶ 		4	4		4	4	4	4
34	5		5	5		5	5	5	5
35	6		6	6		6	6	6	6
36	7		7	7		7	7	7	7
37	8		8	8		8	8	8	8
38	Tun-M	Tuner Mode							
39	9		9	9		9	9	9	9
40	0		0	0		0	0	0	0
41	Memory	Memory							
42	Tune Up	Tune Up	Next Chapter						
43	Direct	Direct Tuner Entry		Track Direct					
44	Clear	Clear	Clear	Clear		Clear	Clear	Clear	Clear

Function List (continued)

No.	Button Name	AVR Function	DVD	CD/CD-R	Tape	VCR (VID1)	TV (VID1)	CBL (VID3)	SAT (VID3)
45	Preset Up	Preset Tune Up	Slow Forward						
46	Tune Down	Tune Down	Prev Chapter	Track Increment					
47	D. Skip		Disc Skip	Disc Skip	Stop	Stop			
48	Preset Down	Preset Tune Down	Slow Rev	Intro Scan					
49	M1		Open/Close	Open/Close		Cancel	Sleep	PPV	Cancel
50	M2		Subtitle On/Off	Repeat				Fav	Fav
51	M3		Audio Select	Random Play				Bypass	Next
52	M4		Angle Select					Music	Alt
53	Rewind		R. Search	R. Search	Rewind	Rewind		Day –	Day –
54	Play		Play	Play	Play	Play			
55	Fast Forward		F. Search	F. Search	Fast Fwd	Fast Fwd		Day +	Day +
56	Record			Record	Record	Record			
57	Stop		Stop	Stop	Stop	Stop			
58	Pause		Pause	Pause	Pause	Pause			
59	Skip Down		Skip –	Skip –		Scan –		Page –	Page –
60	Skip Up		Skip +	Skip +		Scan +		Page +	Page +

Setup Code Table: TV

Manufacturer/Brand	Setup Code Number
A MARK	103 132
ADMIRAL	192
AKAI	123 160
AMPRO	164
ANAM	045 103 106 109 112 122
AOC	103 123 128
BLAUPUNKT	084
BROKSONIC	205 206
CANDLE	123 128
CAPEHART	059
CENTURION	123 171
CENTRONIC	045
CITIZEN	045 123 128 132
CLASSIC	045
CONCERTO	128
CONTEC	045
CORANDO	172
CORONADO	132
CRAIG	045 157 158 159
CROWN	045 132
CURTIS MATHES	123 128 132
CXC	045
DAEWOO	045 087 102 105 106 108 111 114 116 119 127 128 132
DAYTRON	128 132
DIGI LINK	200
DYNASTY	045
DYNATECH	063
ELECTROHOME	115 132
EMERSON	045 123 128 132 139 157 158 159 162 205
FUNAI	045
FUTURETECH	045
GE	087 121 123 128 133 145 159 163
GOLDSTAR	101 103 110 128 132
GRUNDIG	193
HALL MARK	128
HARMAN KARDON	201
HITACHI	123 128 132 144 147
INFINITY	148
INKEL	120
JBL	148
JC PENNEY	115 123 128 132 145
JENSEN	019
JVC	079 087 134
KAWASHO	173
KEC	045
KENWOOD	123 204
KMC	132
KTV	045 123 132 162
LLOYTRON	172 173
LODGENET	069
LOGIK	069
LUXMAN	128
LXI	077 145 148
MAGNAVOX	123 128 132 145 148
MARANTZ	115 123 148
MATSUI	148
MEMOREX	069 128
METZ	084

Setup Code Table: TV (continued)

Manufacturer/Brand	Setup Code Number
MGA	115 123 128
MINERVA	084
MITSUBISHI	077 115 123 128 160 167 168
MTC	175 176
NATIONAL	148 177 179 180 181 182
NEC	115 121 123 125
NIKEI	045
ONKING	045
ONWA	045
OPTONICA	077
ORION	207 208 209 210 211
PANASONIC	087 148 169
PHILCO	045 115 123 128 132 148
PHILIPS	123 128 132 145 148
PIONEER	024 123 128 213 214
PORTLAND	128 132
PROSCAN	133
PROTON	059 122 128 132 165
QUASAR	087
RADIO SHACK	045 128 132 180 196 197
RCA	115 123 128 133 145 161 163
REALISTIC	045 196 197
RUNCO	152 153
SAA	183
SAMPO	059 123 128
SAMSUNG	124 128 132 145
SANYO	054
SCOTT	045 128 132
SEARS	128 132 145
SHARP	077 128 132
SIEMENS	084
SIGNATURE	069
SONY	117 130 136 194 212
SOUNDESIGN	045 128
SPECTRICON	103
SSS	045
SYLVANIA	123 128 145 148
SYMPHONIC	184
TANDY	077
TATUNG	063
TECHNICS	080
TECHWOOD	128
TEKNIKA	045 069 115 123 128 132
TELERENT	069
TERA	156
THOMSON	190 191
TMK	128
TOSHIBA	063 129 202
TOTEVISION	132
VIDEO CONCEPTS	160
VIDTECH	128
WARDS	069 128 132 148
YAMAHA	123 128
YORK	128
YUPITERU	045
ZENITH	069 090
ZONDA	103

Setup Code Table: VCR

Manufacturer/Brand	Setup Code Number
AIWA	040
AKAI	048 108 109 126
AMPRO	076
ASA	134
AUDIO DYNAMICS	018 048
BROKSONIC	110 147
CANDLE	134 135
CANON	135 140
CAPEHART	094
CITIZEN	134
CRAIG	045 116
DAEWOO	017 094 104
DAYTRON	094
DBX	018 048
DYNATECH	040
EMERSON	013 040 042 110 112
FISHER	017
FUNAI	040
GE	076 095 124
GO VIDEO	113
GOLDSTAR	018 107
HARMAN KARDON	018 049
HITACHI	040 048
JC PENNEY	018 045
JENSEN	048
JVC	018 048 111 132
KENWOOD	020 048
LLOYD	040
LXI	020 040
MAGIN	045
MAGNAVOX	040
MARANTZ	018
MEMOREX	017 020 040 076
MGA	049
MITSUBISHI	049 131
MULTITECH	040
NAD	139
NATIONAL	140
NEC	018 048
NORDMENDE	048
OPTIMUS	159
ORION	147
PANASONIC	125 150 167 172
PHILCO	040
PHILIPS	040 075
PORTLAND	094
PULSAR	076
QUASAR	001 125
RADIO SHACK	134 140 142 158 159
RCA	095 124 125 157 172
REALISTIC	017 020 040 045 159

Setup Code Table: VCR (continued)

Manufacturer/Brand	Setup Code Number
SALORA	020
SAMSUNG	045 095 105 109
SANSUI	048 116 147
SANYO	017 020
SCOTT	110 112
SEARS	017 020
SHARP	129 156
SONY	080 129
SOUNDESIGN	040
SYLVANIA	040
SYMPHONIC	040
TANDY	017 040
TASHICO	134
TATUNG	048
TEAC	040 048
TEKNIKA	040
THOMAS	040
TMK	013
TOSHIBA	112 155
TOTEVISION	045
UNITECH	045
VECTOR RESEARCH	018
VIDEO CONCEPTS	018 040
VIDEOSONIC	045
WARDS	040 045 112
YAMAHA	018 040 048
ZENITH	040 076 083

Setup Code Table: CD

Manufacturer/Brand	Setup Code Number
ADCOM	063 069
AIWA	072 111 118 156 170
AKAI	050 177 184
AUDIO TECHNICA	053
AUDIOACCESS	125
AUDIOFILE	211
BSR	044
CALIFORNIA AUDIO	015 109
CAPETRONIC	070
CARRERA	087
CARVER	136 140 141 143 144 145 185 186
CASIO	117 122 166
CLARINETTE	122 166
DENON	187 188 213
EMERSON	052 093 108
FISHER	055 068
FRABA	117
FUNAI	126
GE	164

Setup Code Table: CD (Continued)

Manufacturer/Brand	Setup Code Number
GENEXXA	108
GOLDSTAR	016 087
HAITAI	099 214
HARMAN KARDON	001 002 025 054 190 218 219
HITACHI	093
INKEL	216
JC PENNEY	098 147
JENSEN	153
JVC	176 195 196
KENWOOD	030 062 078 079 148 151 176 178 181
LOTTE	108
LUXMAN	077 102
LXI	164
MAGNAVOX	039 113
MARANTZ	058 084 191 192 193
MCINTOSH	194
MCS	080 098
MITSUMI	152
MODULAIRE	122 166
NAD	013 074 197 198
NAKAMICHI	199 200 201
NEC	069
NIKKO	053 055
ONKYO	037 038 045 046 171 175 202 203
OPTIMUS	065 089 091 092 099 104 212
PANASONIC	015 075 109 119 158 183 204
PHILIPS	039 138 149 209
PIONEER	071 094 100 112 123 131 161 162 215
PROTON	210
QUASAR	015 109
RADIO SHACK	122 126 213
RCA	024 081 093 150
RCX	169
REALISTIC	058 093 095 104 105 108 164 166
SANSUI	047 081 134 157 172
SANYO	033 068 082 095 168
SCOTT	108
SHARP	058 105 114 151 159 167 180 181
SHERWOOD	003 041 058 105 133
SONY	103 115 116 118 132 139 163 205 206 207 208 212 217
SOUNDSTREAM	124
SYMPHONIC	059 110
TAEKWANG	177
TEAC	011 058 085 086 106 107 110 121 137 146 154
THETA DIGITAL	039
TOSHIBA	013 074 097 151 155 173
VECTOR RESEARCH	087
VICTOR	120 130
WARDS	095
YAMAHA	019 031 053 061 135 169
YORK	122 166

Setup Code Table: Tape

Manufacturer/Brand	Setup Code Number
HARMAN KARDON	001

Setup Code Table: DVD

Manufacturer/Brand	Setup Code Number
APEX DIGITAL	061
DENON	019 051
GE	003 004
GOLDSTAR	005
HARMAN KARDON	001
JVC	006
LG	005 055 064
MAGNAVOX	056
MARANTZ	059
mitsubishi	023
NAD	062
ONKYO	009 048
PANASONIC	024 030 044
PHILIPS	056
PIONEER	041 065
PROCEED	060
PROSCAN	003 004
RCA	003 004
SAMSUNG	053 054
SHARP	028
SONY	043 045
THOMSON	003 004
TOSHIBA	009 058
YAMAHA	030 063
ZENITH	005 055 064

Setup Code Table: SAT

Manufacturer/Brand	Setup Code Number
ALPHASTAR	472
ALPHASTAR DBS	450
ALPHASTAR DSR	442
BIRDVIEW	425
CHANNEL MASTER	320 321 322 325 361
CHAPARRAL	315 316 380 451
CITOH	360
DRAKE	313 317 318 413 481
DX ANTENNA	331 352 362 379 483
ECHOSTAR	395 397 452 453 463 477 478 484 485
ELECTRO HOME	392
FUJITSU	324 329 334
GENERAL INSTRUMENT	303 311 323 365 403 454 468 474
HITACHI DBS	455
HOUSTON TRACKER	463
HUGHES	437
JANIEL	366
JERROLD	454 468 484
KATHREIN	410
LEGEND	453
MACOM	317 365 369 370 371
MAGNAVOX	461 473
MEMOREX	453
NEXTWAVE	423
NORSAT	373
OPTIMUS	466
PANASONIC	366 469
PANASONIC DBS	457
PANSAT	420
PERSONAL CABLE	418
PHILIPS	375
PICO	407
PRESIDENT	381 404
PRIMESTAR	412 454 468 475
RCA	301 439 458 465
REALISTIC	349 480
SAMSUNG	442
SATELLITE SERVICE CO	335 388
SCIENTIFIC ATLANTA	339
SONY	405
STAR CHOICE DBS	459
STARCAST	347
SUPER GUIDE	327 423
TEECOM	330 333 390 391 393 409
TOSHIBA	302 426 460 461 462 470
UNIDEN	323 332 348 349 350 351 354 355 381 383 389 403 466 479 480
ZENITH	384 385 387 394 419

Setup Code Table: CBL

Manufacturer/Brand	Setup Code Number
ABC	001 011
ALLEGRO	111
AMERICAST	212
ARCHER	112
BELCOR	113
CABLE STAR	033 113
CITIZEN	111
COLOUR VOICE	085 090
DIGI	114
EAGLE	186
EASTERN	066 070
ELECTRICORD	039
EMERSON	112
FOCUS	116
G.I.	001 011 017 096 097
GC ELECTRONICS	113
GEMINI	032 060
GENERAL	210
GENERAL INSTRUMENT	168
GOODMIND	112
HAMLIN	056 099 100 101 117 175 208
HITACHI	001 188
JASCO	111
JERROLD	001 002 011 017 073 096 097 162 168 188 210
LINDSAY	118
MACOM	191
MAGNAVOX	017 019 068
MOVIE TIME	035 039
NSC	035 190
OAK	197
PACE	179
PANASONIC	053 176 177 189 214
PANTHER	114
PHILIPS	013 019 020 085 090
PIONEER	001 041 119 171 209
POPULAR MECHANICS	116
PRELUDE	120
PRIMESTAR	162
RADIO SHACK	111 112 213
RCA	053 214
RECOTON	116
REGAL	056 099 100 101 208

Setup Code Table: CBL (continued)

Manufacturer/Brand	Setup Code Number
REMBRANT	032
SAMSUNG	072 186
SCIENTIFIC ATLANTA	183 203
SEAM	121
SIGNATURE	001 188
SPRUCER	053 081 177 189
STARCOM	002 011 163
STARGATE	120
TANDY	024
TELECAPATION	028
TEXSCAN	036
TFC	122
TIMELESS	123
TOCOM	170 205
UNITED CABLE	011
UNIVERSAL	033 034 039 042 113
VIDEOWAY	124 211
VIEWSTAR	019 025 086 089 190
ZENITH	065 125 211
ZENTEK	116

Troubleshooting Guide

Your AVR 120 receiver has been designed to provide many years of trouble-free service. In the event that you are experiencing difficulties, please check the suggestions below for a possible solution to your problem. Additional information on the AVR 120, including updated information and user hints, is available from our Web site at www.harmankardon.com.

SYMPTOM	CAUSE	SOLUTION
Unit does not function when Main Power Switch is pushed	<ul style="list-style-type: none"> No AC Power 	<ul style="list-style-type: none"> Make certain AC power cord is plugged into a live outlet Check to see whether outlet is switch-controlled
Display lights, but no sound or picture	<ul style="list-style-type: none"> Intermittent input connections Mute is on Volume control is down 	<ul style="list-style-type: none"> Make certain that all input and speaker connections are secure Press Mute button Turn up volume control
Unit turns on, but front-panel display does not light up	<ul style="list-style-type: none"> Display brightness is turned off 	<ul style="list-style-type: none"> Follow the instructions in the Display Brightness section on page 26 so that the display is set to VFD FULL
No sound from any speaker; light around power switch is red	<ul style="list-style-type: none"> Amplifier is in protection mode due to possible short Amplifier is in protection mode due to internal problems 	<ul style="list-style-type: none"> Check speaker wire connections for shorts at receiver and speaker ends Contact your local Harman Kardon service center, which you can locate by visiting our Web site at www.harmankardon.com
No sound from surround or center speakers	<ul style="list-style-type: none"> Incorrect surround mode Input is monaural Incorrect configuration Stereo or Mono program material 	<ul style="list-style-type: none"> Select a mode other than Stereo or Dolby 3 Stereo There is no surround information from mono sources Check speaker mode configuration The surround decoder may not create center- or rear-channel information from nonencoded programs
Unit does not respond to remote commands	<ul style="list-style-type: none"> Weak batteries in remote Wrong device selected Remote sensor is obscured 	<ul style="list-style-type: none"> Change remote batteries Press the AVR selector Make certain front-panel sensor is visible to remote or connect remote sensor
Intermittent buzzing in tuner	<ul style="list-style-type: none"> Local interference 	<ul style="list-style-type: none"> Move unit or antenna away from computers, fluorescent lights, motors or other electrical appliances
Letters flash in the channel indicator display and digital audio stops	<ul style="list-style-type: none"> Digital audio feed paused 	<ul style="list-style-type: none"> Resume play for DVD Check that Digital Input is selected

Processor Reset

In the rare case where the unit's operation or the displays seem abnormal, the cause may involve the erratic operation of the system's memory or microprocessor.

To correct this problem, first unplug the unit from the AC wall outlet and wait at least three minutes. After the pause, reconnect the AC power cord and check the unit's operation. If the system still malfunctions, a system "reset" may clear the problem.

To clear the AVR 120's entire system memory including tuner presets, output level settings, delay times and speaker configuration data, first put the unit in Standby by pressing the

System Power Control Button **2**. Next, simultaneously press and hold the **Tone Mode** **6** and the **FM Mode Selector** **12** buttons for three seconds.

The unit will turn on automatically and display the **RESET** message in the **Main Information Display** **14**. Note that once you have cleared the memory in this manner, it is necessary to reestablish all system configuration settings and tuner presets.

NOTE: After a reset, the unit will be returned to the factory presets, and all settings for tuner memory and presets speaker configuration, delay times and surround mode memories must be reentered.

If the system is still operating incorrectly, there may have been an electronic discharge or severe AC line interference that has corrupted the memory or microprocessor.

If these steps do not solve the problem, consult an authorized Harman Kardon service center. You can locate the service center nearest to you by visiting our Web site at www.harmankardon.com.

Memory Backup

This product is equipped with a memory backup system that preserves the system configuration information and tuner presets if the unit is accidentally unplugged or subjected to a power outage. This memory will last for approximately two weeks, after which time all information must be reentered.

Technical Specifications

Audio Section

Stereo Mode

Continuous Average Power (FTC)

50 Watts per channel, @ < 0.07% THD, 20Hz – 20kHz,
both channels driven into 8 ohms

Five-Channel Surround Modes

Power Per Individual Channel

Front L&R channels:

40 Watts per channel

@ < 0.07% THD, 20Hz–20kHz into 8 ohms

Center channel:

40 Watts @ < 0.07% THD, 20Hz–20kHz into 8 ohms

Surround channels:

40 Watts per channel

@ < 0.07% THD, 20Hz–20kHz into 8 ohms

Input Sensitivity/Impedance

Linear (High-Level) 200mV/47k ohms

Signal-to-Noise Ratio (IHF-A) 95dB

Surround System Adjacent Channel Separation

Pro Logic II 45dB

Dolby Digital (AC-3) 55dB

DTS 55dB

Frequency Response

@ 1W (+0dB, –3dB) 10Hz–100kHz

High Instantaneous

Current Capability (HCC) ±25 Amps

Transient Intermodulation

Distortion (TIM) Unmeasurable

Slew Rate 40V/μsec

FM Tuner Section

Frequency Range	87.5–108.0MHz
Usable Sensitivity	IHF 1.3μV/13.2dBf
Signal-to-Noise Ratio	Mono/Stereo 70dB/68dB
Distortion	Mono/Stereo 0.2%/0.3%
Stereo Separation	40dB @ 1kHz
Selectivity	±400kHz, 70dB
Image Rejection	80dB
IF Rejection	90dB

AM Tuner Section

Frequency Range	520–1710kHz
Signal-to-Noise Ratio	45dB
Usable Sensitivity	Loop 500μV
Distortion	1kHz, 50% Mod 0.8%
Selectivity	±10kHz, 30dB

Video Section

Television Format	NTSC
Input Level/Impedance	1Vp-p/75 ohms
Output Level/Impedance	1Vp-p/75 ohms
Video Frequency Response	10Hz–8MHz (–3dB)

General

Power Requirement	AC 120V/60Hz
Power Consumption	68W idle, 540W maximum (2 channels driven)
Dimensions	
Width	17.3 inches (440mm)
Height	6.5 inches (165mm)
Depth	17.1 inches (435mm)
Weight	31 lb (14.1kg)

Depth measurement includes knobs, buttons and terminal connections.

Height measurement includes feet and chassis.

All features and specifications are subject to change without notice.

Harman Kardon is a registered trademark, and Power for the Digital Revolution is a trademark, of Harman Kardon, Inc.

*Manufactured under license from Dolby Laboratories.

Dolby, Pro Logic II, AC-3 and the Double-D symbol are trademarks of Dolby Laboratories. Confidential Unpublished Works. ©1992–1999 Dolby Laboratories, Inc. All rights reserved.

DTS and DTS Surround are registered trademarks of Digital Theater Systems, Inc.

UltraStereo is a trademark of UltraStereo Corp.

VMaX is a registered trademark of Harman International Industries, Inc., and is an implementation of Cooper Bauck Transaural Stereo under patent license.

Logic 7 is a registered trademark of Lexicon, Inc., a Harman International Company.

Crystal is a registered trademark of Cirrus Logic Corp.

harman/kardon®

H A Harman International Company
250 Crossways Park Drive, Woodbury, New York 11797
www.harmankardon.com
© 2001 Harman Kardon, Incorporated
Part No.: J90200012410

Free Manuals Download Website

<http://myh66.com>

<http://usermanuals.us>

<http://www.somanuals.com>

<http://www.4manuals.cc>

<http://www.manual-lib.com>

<http://www.404manual.com>

<http://www.luxmanual.com>

<http://aubethermostatmanual.com>

Golf course search by state

<http://golfingnear.com>

Email search by domain

<http://emailbydomain.com>

Auto manuals search

<http://auto.somanuals.com>

TV manuals search

<http://tv.somanuals.com>