

AVR 5000 Audio/Video Receiver

OWNER'S MANUAL

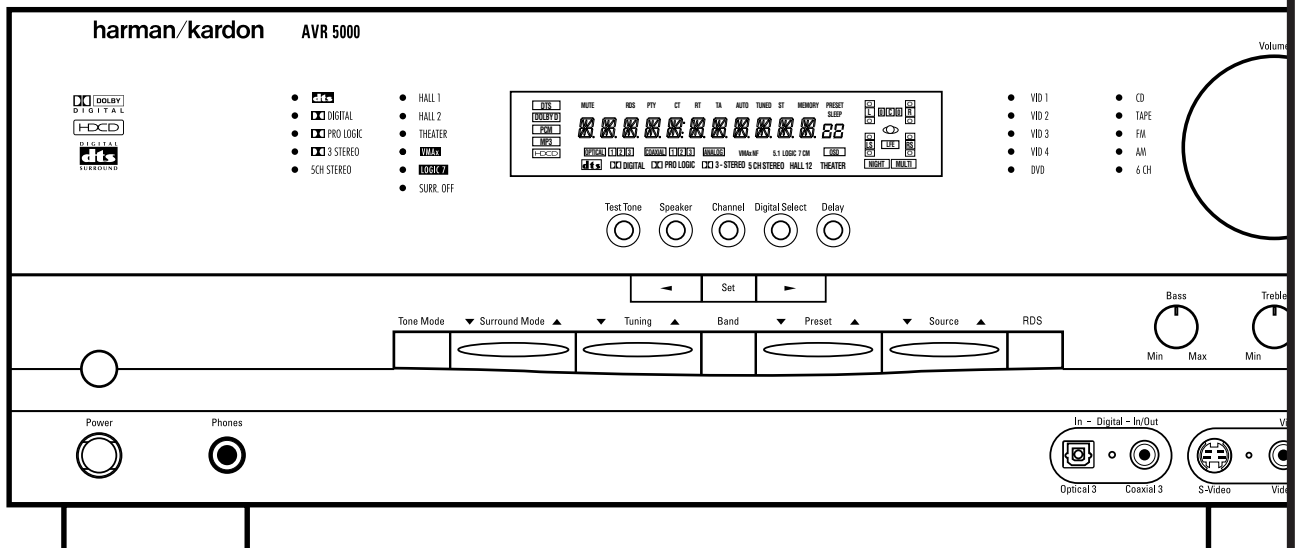

harman/kardon®

Power for the Digital Revolution™

Table of Contents

3	Introduction
4	Safety Information
5	Front Panel Controls
7	Front Panel Information Display
9	Rear Panel Connections
11	Main Remote Control Functions
14	Zone II Remote Control Functions
15	Installation and Connections
19	System Configuration
19	Speaker Selection and Placement
20	First Turn On and Use of OSD
20	Settings to be Made With Each Input Used
21	Input Setup
21	Surround Setup
22	Speaker Setup
23	Adjustments for Other Inputs
23	Making Settings independent of selected Input
23	Delay Settings
24	Night Mode Settings
24	Output Level Adjustment
25	Using EzSet
25	Manual Output Level Adjustment
27	Operation
27	Basic Operation
27	Source Selection
27	Controls and Use of Headphones
28	Surround Mode Chart
29	Surround Mode Selection
29	Digital Audio Playback
31	Tape Recording
32	Output Level Trim Adjustment
33	6-Channel Direct Input
33	Memory Backup
33	Tuner Operation
34	RDS Operation
36	Advanced Features
36	Display Brightness
36	Turn On Volume Level
37	Semi OSD Settings
37	Full-OSD Time Out Adjustment
38	Multiroom Operation
39	Programming the Remote
39	Programming the Remote with Codes
40	Code Readout
40	Learning Codes From a Remote
41	Macro Programming
42	Programmed Device Function
42	Volume Punch-Through
43	Channel Control Punch-Through
43	Transport Control Punch-Through
43	Reassigning Device Control Selectors
43	Resetting the Remote Memory
44	Function List
46	Setup Code Tables
56	Troubleshooting Guide
56	Processor Reset
57	Technical Specifications

Declaration of Conformity



We, Harman Consumer International
2, route de Tours
72500 Château-du-Loir,
FRANCE

declare in own responsibility, that the product described in
this owner's manual is in compliance with technical stan-
dards:

EN 55013/6.1990

EN 55020/12.1994

EN 60065:1993

EN 61000-3-2/4.1995

Carsten Olesen
Harman Kardon Europe A/S
11/00

Typographical Conventions

In order to help you use this manual with the remote control, front-panel controls and rear-panel connections, certain conventions have been used.

EXAMPLE – (bold type) indicates a specific remote control or front-panel button, or rear-panel connection jack

EXAMPLE – (OCR type) indicates a message that is visible on the front-panel information display

1 – (number in a square) indicates a specific front-panel control

1 – (number in a circle) indicates a rear-panel connection

1 – (number in an oval) indicates a button or indicator on the remote

A – (letter in a square) indicates an indicator in the front-panel display

A – (letter in an oval) indicates a button on the Zone II remote

Introduction

Thank you for choosing Harman Kardon!

With the purchase of a Harman Kardon AVR5000 you are about to begin many years of listening enjoyment. The AVR5000 has been custom designed to provide all the excitement and detail of movie sound tracks and every nuance of musical selections. With onboard Dolby* Digital and DTS¹ decoding, the AVR5000 delivers six discrete channels of audio that take advantage of the digital sound tracks from the latest DVD and LD releases and Digital Television broadcasts.

While complex digital systems are hard at work within the AVR5000 to make all of this happen, hookup and operation are simple. Color-keyed connections, a backlit, programmable and learning remote control, and on-screen menus make the AVR5000 easy to use. To obtain the maximum enjoyment from your new receiver, we urge you to take the time to read through this manual. This will ensure that connections to speakers, source playback units and other external devices are made properly. In addition, a few minutes spent learning the functions of the various controls will enable you to take advantage of all the power the AVR5000 is able to deliver.

If you have any questions about this product, its installation or its operation, please contact your dealer. He is your best local source of information.

Description and Features

The AVR5000 is among the most versatile and multi-featured A/V receivers available, incorporating a wide range of listening options. In addition to Dolby Digital and DTS decoding for digital sources, a broad choice of analog surround modes are available for use with sources such as CD, VCR, TV broadcasts and the AVR's own FM/AM tuner. Along with Dolby Pro Logic,* Dolby 3 Stereo, 5 Ch Stereo and custom Hall and Theater modes, only Harman Kardon receivers offer Logic 7[®] to create a wider, more enveloping field environment and more defined fly-overs and pans.

Finally, the AVR5000 is among the very few A/V receivers that offer decoding of MP3 data, so that you may listen to the latest music selections directly from compatible computers or playback devices with the power and fidelity you expect from Harman Kardon.

Another Harman Kardon exclusive is VMAx™, which uses proprietary processing to create an open, spacious sound field even when only two front speakers are available.

The AVR 5000 is also able to offer HDCD[®] decoding to provide the most realistic playback of CDs when a digital connection is used, even with a normal non-HDCD-compatible CD or DVD player.

In addition to providing a wide range of listening options, the AVR5000 is easy to configure so that it provides the best results with your speakers and specific listening-room environment. On-screen menus make it simple to enter settings for speakers, inputs and delay times, while our exclusive EzSet™ remote measures a system's sound levels and automatically calibrates them for perfectly balanced soundfield presentation.

For the ultimate in flexibility, the AVR5000 features connections for five video devices, all with both composite and S-Video inputs. Two additional audio inputs are available, and a total of six digital inputs make the AVR5000 capable of handling all the latest digital audio sources. For compatibility with the latest DVD players and digital video products, the AVR5000 also features component video switching. Coax and optical digital outputs are available for direct connection to digital recorders, and both the front panel analog audio/video and the coaxial digital jacks may be switched to an output for use with portable recorders – a Harman Kardon exclusive. Two video recording outputs, preamp-out/main-in jacks, and a six channel input make the AVR5000 virtually future-proof, with everything needed to accommodate tomorrow's new formats right on board.

The AVR5000's flexibility and power extend beyond your main home theater or listening room. The AVR includes a sophisticated multi-zone control system that allows you to select one source for use in the main room and a different one in a second room. Left and right front channel audio is routed to the remote room location, with complete control over volume provided by a separate infrared control link. To make it easy to operate the AVR 5000 from a remote room, a separate Zone II remote is included.

The AVR5000's powerful amplifier uses traditional Harman Kardon high-current design technologies to meet the wide dynamic range of any program selection.

Harman Kardon invented the high-fidelity receiver more than forty-seven years ago. With state-of-the-art circuitry and time-honored circuit designs, the AVR5000 is one of the finest receivers ever offered by Harman Kardon.

- **Onboard Dolby Digital and DTS Decoding Using Crystal[®] Chip Technology**
- **Harman Kardon's Exclusive Logic 7 and VMAx Modes**
- **MP3 Decoding for Use with compatible Computers and Digital Audio Players**
- **EzSet[™] Remote Automatically Sets Output Levels for Optimum Performance**
- **Front-Panel Analog A/V Inputs switchable to Outputs**
- **Front-Panel Digital Inputs and Coax Digital Output Capability for Easy Connection to Portable Digital Devices and the Latest Video Game Consoles**
- **Multiple Digital Inputs and Outputs**
- **On-Screen Menu and Display System**
- **6-Channel Direct Input and Preamp Outputs and Main Amp Inputs for Easy Expansion and Use with Future Audio Formats**
- **Complete Multi-Zone System with Separate "Zone II" Remote Included[™]**
- **Main Backlit Remote with Internal Codes and Learning Capability**
- **HDCD Decoding for Superb CD Playback**
- **Component Video Switching**

Safety Information

Important Safety Information

Verify Line Voltage Before Use

Your AVR5000 has been designed for use with 220-240-Volt AC current. Connection to a line voltage other than that for which it is intended can create a safety and fire hazard and may damage the unit.

If you have any questions about the voltage requirements for your specific model, or about the line voltage in your area, contact your dealer before plugging the unit into a wall outlet.

Do Not Use Extension Cords

To avoid safety hazards, use only the power cord attached to your unit. We do not recommend that extension cords be used with this product. As with all electrical devices, do not run power cords under rugs or carpets or place heavy objects on them. Damaged power cords should be replaced immediately by an authorized service depot with a cord meeting factory specifications.

Handle the AC Power Cord Gently

When disconnecting the power cord from an AC outlet, always pull the plug, never pull the cord. If you do not intend to use the unit for any considerable length of time, disconnect the plug from the AC outlet.

Do Not Open the Cabinet

There are no user-serviceable components inside this product. Opening the cabinet may present a shock hazard, and any modification to the product will void your guarantee. If water or any metal object such as a paper clip, wire or a staple accidentally falls inside the unit, disconnect it from the AC power source immediately, and consult an authorized service station.

Installation Location

- To assure proper operation and to avoid the potential for safety hazards, place the unit on a firm and level surface. When placing the unit on a shelf, be certain that the shelf and any mounting hardware can support the weight of the product.
- Make certain that proper space is provided both above and below the unit for ventilation. If this product will be installed in a cabinet or other enclosed area, make certain that there is sufficient air movement within the cabinet. Under some circumstances a fan may be required.
- Do not place the unit directly on a carpeted surface.
- Avoid installation in extremely hot or cold locations, or an area that is exposed to direct sunlight or heating equipment.
- Avoid moist or humid locations.
- Do not obstruct the ventilation slots on the top of the unit, or place objects directly over them.

Cleaning

When the unit gets dirty, wipe it with a clean, soft, dry cloth. If necessary, wipe it with a soft cloth dampened with mild soapy water, then a fresh cloth with clean water. Wipe dry immediately with a dry cloth. NEVER use benzene, aerosol cleaners, thinner, alcohol or any other volatile cleaning agent. Do not use abrasive cleaners, as they may damage the finish of metal parts. Avoid spraying insecticide near the unit.

Moving the Unit

Before moving the unit, be certain to disconnect any interconnection cords with other components, and make certain that you disconnect the unit from the AC outlet.

Unpacking

The carton and shipping materials used to protect your new receiver during shipment were specially designed to cushion it from shock and vibration. We suggest that you save the carton and packing materials for use in shipping if you move, or should the unit ever need repair.

To minimize the size of the carton in storage, you may wish to flatten it. This is done by carefully slitting the tape seams on the bottom and collapsing the carton. Other cardboard inserts may be stored in the same manner. Packing materials that cannot be collapsed should be saved along with the carton in a plastic bag.

If you do not wish to save the packaging materials, please note that the carton and other sections of the shipping protection are recyclable. Please respect the environment and discard those materials at a local recycling center.

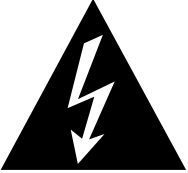

CAUTION
RISK OF ELECTRIC SHOCK
DO NOT OPEN



CAUTION: TO REDUCE THE RISK OF ELECTRIC SHOCK, DO NOT REMOVE COVER (OR BACK). NO USER-SERVICEABLE PARTS INSIDE. REFER SERVICING TO QUALIFIED SERVICE PERSONNEL.



The lightning flash with arrowhead symbol, within an equilateral triangle, is intended to alert the user to the presence of uninsulated "dangerous voltage" within the product's enclosure that may be of sufficient magnitude to constitute a risk of electric shock to persons.



The exclamation point within an equilateral triangle is intended to alert the user to the presence of important operating and maintenance (servicing) instructions in the literature accompanying the appliance.

WARNING: TO REDUCE THE RISK OF FIRE OR ELECTRIC SHOCK, DO NOT EXPOSE THIS APPLIANCE TO RAIN OR MOISTURE.

Front Panel Controls

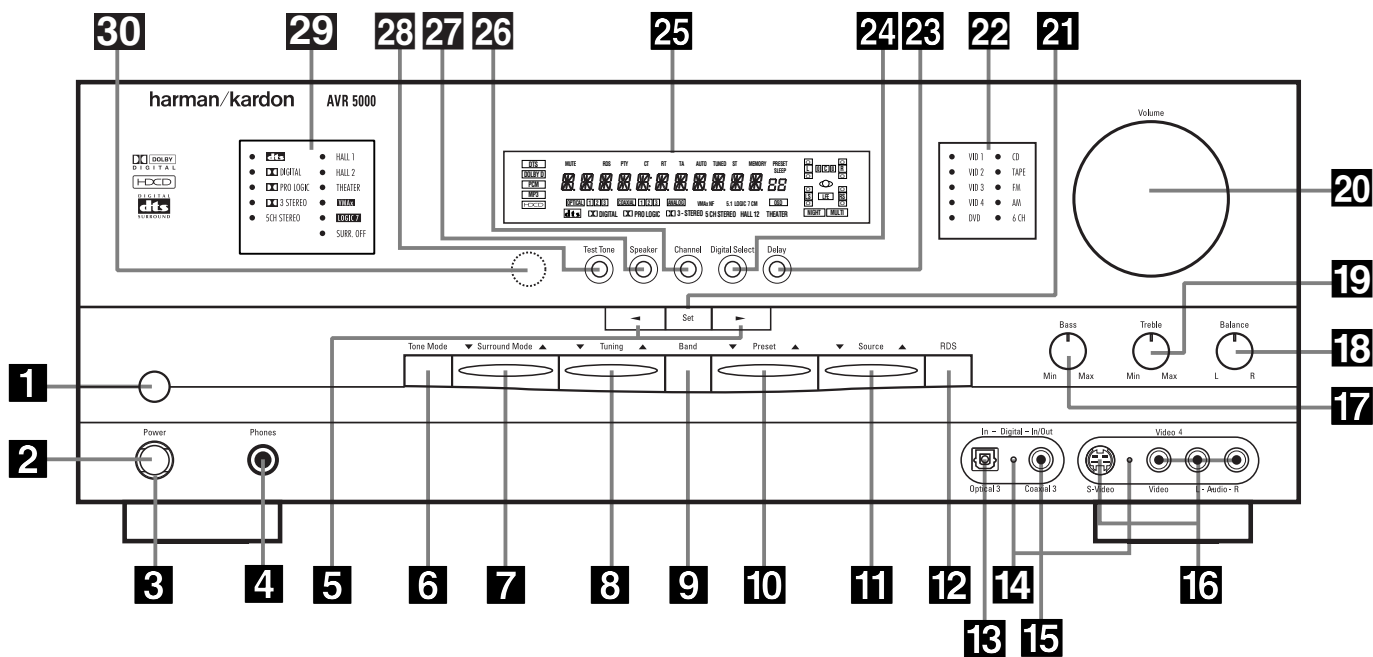

- 1** Main Power Switch
- 2** System Power Control
- 3** Power Indicator
- 4** Headphone Jack
- 5** Selector Buttons
- 6** Tone Mode
- 7** Surround Mode Selector
- 8** Tuning Selector
- 9** Tuner Band Selector
- 10** Preset Stations Selector

- 11** Input Source Selector
- 12** RDS Select Button
- 13** Digital Optical 3 Input
- 14** Input/Output Status Indicators
- 15** Digital Coax 3 Jack
- 16** Video 4 Jacks
- 17** Bass Control
- 18** Balance Control
- 19** Treble Control
- 20** Volume Control

- 21** Set Button
- 22** Input Indicators
- 23** Delay
- 24** Digital Input Selector
- 25** Main Information Display
- 26** Channel Select Button
- 27** Speaker Select Button
- 28** Test Tone Selector
- 29** Surround Mode Indicators
- 30** Remote Sensor Window

1 Main Power Switch: Press this button to apply power to the AVR5000. When the switch is pressed in, the unit is placed in a Standby mode, as indicated by the amber LED **3** surrounding the **System Power Control** **2**. This button **MUST** be pressed in to operate the unit. To turn the unit off completely and prevent the use of the remote control, this switch should be pressed until it pops out from the front panel so that the word "OFF" may be read at the top of the switch.

NOTE: This switch is normally left in the "ON" position.

2 System Power Control: When the **Main Power Switch** **1** is "ON," press this button to turn on the AVR5000; press it again to turn the unit off (to Standby). Note that the **Power Indicator** surrounding the switch **3** will turn green when the unit is on.

3 Power Indicator: This LED will be illuminated in amber when the unit is in the Standby mode to signal that the unit is ready to be turned on. When the unit is in operation, the indicator will turn green.

4 Headphone Jack: This jack may be used to listen to the AVR5000's output through a pair of headphones. Be certain that the headphones have a standard 6.3 mm stereo phone plug. Note that the main room speakers and all Preamp Outputs **11** will automatically be turned off when the headphone jack is in use.

5 Selector Buttons: When you are establishing the AVR5000's configuration settings, use these buttons to select from the choices available, as shown in the **Main Information Display** **25**.

6 Tone Mode: Pressing this button enables or disables the Balance, Bass and Treble tone controls. When the button is pressed so that the words **TONE IN** appear in the **Main Information Display** **25**, the settings of the **Bass** **17** and **Treble** **19** controls and of the **Balance** control **18** will affect the output signals. When the button is pressed so that the words **TONE OUT** appear in the **Main Information Display** **25**, the output signal will be "flat," without any balance, bass or treble alteration.

Front Panel Controls

7 Surround Mode Selector: Press this button to change the surround mode by scrolling through the list of available modes. Note that Dolby Digital and DTS modes can be selected only when a digital input is used (See page 28 for more information about surround modes.)

8 Tuning Selector: Press the left side of the button to tune lower frequency stations and the right side of the button to tune higher frequency stations. When a station with a strong signal is reached, the **TUNED** indicator **W** will illuminate in the **Main Information Display 25** (see page 33 for more information on tuning stations).

9 Tuner Band Selector: Pressing this button will automatically switch the AVR to the Tuner mode. Pressing it again will switch between the AM and FM frequency bands, holding it pressed for some seconds will switch between stereo and mono receiving and between automatic and manual tuning mode (See page 33 for more information on the tuner).

10 Preset Stations Selector: Press this button to scroll up or down through the list of stations that have been entered into the preset memory. (See page 33 for more information on tuner programming.)

11 Input Source Selector: Press this button to change the input by scrolling through the list of input sources.

12 RDS Select Button: Press this button to display the various messages that are part of the RDS data system of the AVR5000's tuner. (See page 34 for more information on RDS).

13 Digital Optical 3 Input: Connect the optical digital audio output of an audio or video product to this jack. When the Input is not in use, be certain to keep the plastic cap installed to avoid dust contamination that might degrade future performance.

14 Input/Output Status Indicators: These LED indicators will normally light green to show that the front panel Video 4 A/V jacks or the Coaxial 3 digital jack is operating as an input. When either of these jacks has been configured for use as an output, the indicator will turn red to show that the jack may be used for recording. (See page 21 for more information on configuring the front panel jacks as outputs, rather than inputs.)

15 Digital Coax 3 Jack: This jack is normally used for connection to the output of portable audio devices, video game consoles or other products that have a coax digital jack. It may also be configured as an output jack, to feed a digital signal to a CD-R, MiniDisc or other digital recording device. (See page 21 for information on configuring the Digital Coax 3 Jack to an output.)

16 Video 4 Jacks: These audio/video jacks may be used for temporary connection to video games or portable audio/video products such as camcorders and portable audio players. They may also be configured as output jacks to feed a signal to any recording Audio or Video device (see page 21 for more information).

17 Bass Control: Turn this control to modify the low frequency output of the left/right channels by as much as ± 10 dB. Set this control to a suitable position for your taste or room acoustics.

18 Balance Control: Turn this control to change the relative volume for the front left/right channels.

NOTE: For proper operation of the surround modes this control should be at the midpoint or "12 o'clock" position.

19 Treble Control: Turn this control to modify the high frequency output of the left/right channels by as much as ± 10 dB. Set this control to a suitable position for your taste or room acoustics.

20 Volume Control: Turn this knob clockwise to increase the volume, counterclockwise to decrease the volume. If the AVR is muted, adjusting volume control will automatically release the unit from the silenced condition.

21 Set Button: When making choices during the setup and configuration process, press this button to enter the desired setting as shown in the **Main Information Display 25** into the AVR5000's memory. The set button may also be used to change the display brightness. (See page 36.)

22 Input indicators: A green LED will light in front of the input that is currently being used as the source for the AVR5000.

23 Delay: Press this button to begin the sequence of steps required to enter delay time settings. (See pages 23 for more information on delay times.)

24 Digital Input Selector: When playing a source that has a digital output, press this button to select between the **Optical 13 23** and **Coaxial 15 29 Digital** inputs. (See pages 29-31 for more information on digital audio.)

25 Main Information Display: This display delivers messages and status indications to help you operate the receiver. (See pages 7-8 for a complete explanation of the Information Display.)

26 Channel Select Button: Press this button to begin the process of trimming the channel output levels using an external audio source. (For more information on output level trim adjustment, see page 32.)

27 Speaker Select Button: Press this button to begin the process of selecting the speaker positions that are used in your listening room. (See page 22 for more information on setup and configuration.)

28 Test Tone Selector: Press this button to begin the process of adjusting the channel output levels using the internal test tone as a reference. (For more information on output level adjustment, see page 26.)

29 Surround Mode Indicators: A green LED will light in front of the surround mode that is currently in use.

30 Remote Sensor Window: The sensor behind this window receives infrared signals from the remote control. Aim the remote at this area and do not block or cover it unless an external remote sensor is installed.

Front Panel Information Display

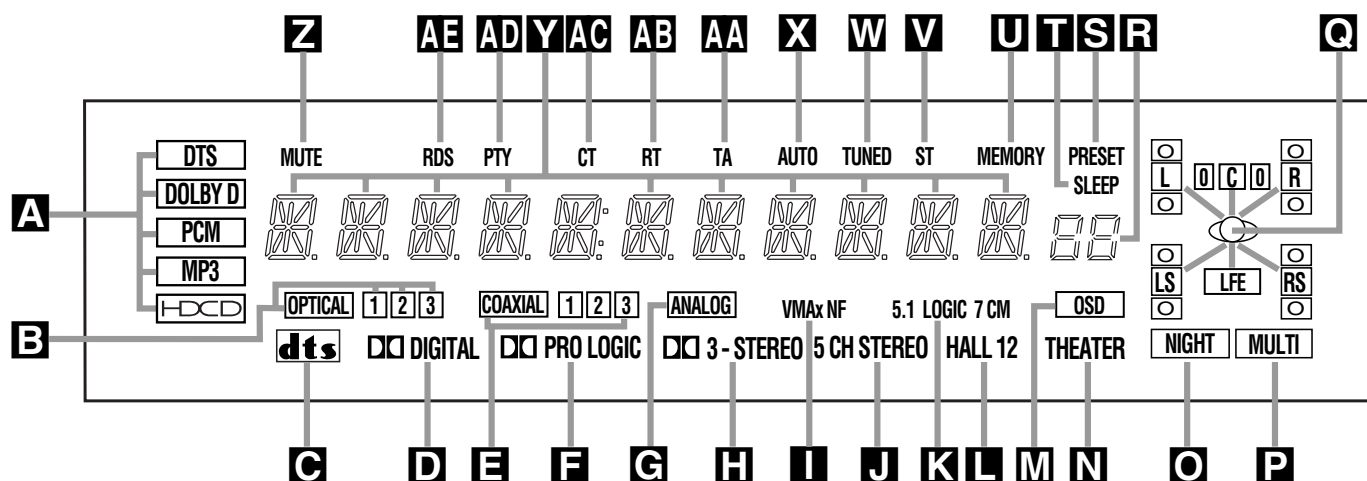

A Bitstream Indicators

B Optical Source Indicators

C DTS Mode Indicator

D Dolby Digital Indicator

E Coaxial Source Indicators

F Dolby Pro Logic Indicator

G Analog Input Indicator

H Dolby 3 Stereo Indicator

I VMAx Mode Indicator

J 5 Channel Stereo Indicator

K Logic 7 Mode Indicators

L Hall Mode Indicator

M OSD Indicator

N Theater Mode Indicator

O Night Mode Indicator

P Multiroom Indicator

Q Speaker/Channel Input Indicators

R Preset Number/Sleep Timer

S Preset Indicator

T Sleep Indicator

U Memory Indicator

V Stereo Indicator

W Tuned Indicator

X Auto Indicator

Y Main Information Display

Z Mute Indicator

AA Traffic Indicator

AB Radiotext Indicator

AC Clock Timer Indicator

AD Program Type Indicator

AE RDS Indicator

A Bitstream™ Indicators: When the input is a digital source, one of these indicators will light to display the specific type of signal in use.

B Optical Source Indicators: These indicators light to show when a Optical Digital Input has been selected.

C DTS Mode Indicator: This indicator illuminates when the DTS mode is selected.

D Dolby Digital Indicator: This indicator illuminates when Dolby Digital mode is selected.

E Coaxial Source Indicators: These indicators light to show when a Coaxial Digital Input has been selected.

F Dolby Pro Logic Indicator: This indicator lights when the Dolby ProLogic mode has been selected.

G Analog Input Indicator: This indicator lights when an analog input source has been selected.

H Dolby 3 Stereo Indicator: This indicator lights when the Dolby 3 Stereo Mode has been selected.

I VMAx Mode Indicator: This indicator illuminates to show that the VMAx mode is in use. **VMAx F** appears when the Far Field VMAx mode is selected; **VMAx N** appears when the Near Field VMAx mode is selected. (See page 28 for a description of the VMAx Modes.)

J 5 Channel Stereo Indicator: This indicator lights when the 5 Channel Stereo mode has been selected.

K Logic 7 Mode Indicators: These indicators illuminate when the Logic 7 mode is in use. **LOGIC 7C** appears for the Cinema version of Logic 7, **LOGIC 7M** appears for the Music version of Logic 7. (See page 28 for a description of the Logic 7 Modes.)

L Hall Mode Indicators: These indicators light when one of the Hall modes has been selected.

M OSD Indicator: When the OSD system is in use, this indicator lights to remind you that the other indicators in this display do not function when the On Screen Display is being used.

N Theater Mode Indicator: This indicator illuminates to show that the Theater mode is in use.

O Night Mode Indicator: This indicator lights when the AVR5000 is in the Night mode, which preserves the dynamic range of digital program material at low volume levels.

P Multiroom Indicator: This indicator lights when the multiroom system is active. Note that it will remain lit when the multiroom system is in use even though the main room system is in the Standby mode and all other indicators are dark. (See page 38 for more information on the Multiroom system.)

Q Speaker/Channel Input Indicators: These indicators are multipurpose, indicating either the speaker type selected for each channel or the incoming data-signal configuration. The left, center, right, right surround and left surround speaker indicators are composed of three boxes, while the subwoofer is a single box. The center box lights when a "Small" speaker is selected, and the two outer boxes light when "Large" speakers are selected. When none of the boxes are lit for the center, surround or subwoofer channels, no speaker has been selected for that position. (See page 22 for more information on configuring speakers.) The letters inside each of the center boxes display active input channels. For standard analog inputs, only the L and R will light, indicating a stereo input. When a digital source is playing, the indicators will light to display the channels begin received at the digital input. When the letters flash, the digital input has been interrupted. (See page 31 for more information on the Channel Indicators.)

R Preset Number/Sleep Timer: When the tuner is in use, these numbers indicate the specific preset memory location in use. (See page 33 for more information on preset stations.) When the Sleep function is in use, these numbers show how many minutes remain before the unit goes into the Standby mode.

Front Panel Information Display

S Preset Indicator: This indicator lights when the tuner is in use to show that the **Preset Number/Sleep Timer** **R** is showing the station's preset memory number. (See page 33 for more information on tuner presets.)

T Sleep Indicator: This indicator lights when the Sleep function is in use. The numbers in the Preset/Sleep Number Indicators will show the minutes remaining before the AVR5000 goes into the Standby mode. (See page 27 for more information on the Sleep function.)

U Memory Indicator: This indicator flashes when entering presets and other information into the tuner's memory.

V Stereo Indicator: This indicator illuminates when an FM station is being tuned in stereo.

W Tuned Indicator: This indicator illuminates when a station is being received with sufficient signal strength to provide acceptable listening quality.

X Auto Indicator: This indicator illuminates when the tuner's Auto mode is in use.

Y Main Information Display: This display shows messages relating to the status, input source, surround mode, tuner, volume level or other aspects of unit's operation.

Z Mute Indicator: This indicator illuminates to remind you that the AVR5000's output has been silenced by pressing the **Mute** button **38**. Press the Mute button again to return to the previously selected output level.

AA TA Traffic Announcement Indicator: This indicator illuminates if the RDS station tuned sometimes transmits traffic information (see page 34 for more information on RDS).

AB RT Text Indicator: This indicator illuminates when the RDS station tuned is transmitting radiotext (RT) data.

AC Clock Time Indicator: This indicator illuminates when the RDS station tuned is transmitting the CT (clock time) code, indicating the current time of day.

AD PTY Indicator: This indicator illuminates when the RDS station tuned is transmitting program type data, or during a PTY search.

AE RDS Indicator: This indicator illuminates when the station tuned is transmitting RDS data.

Rear Panel Connections

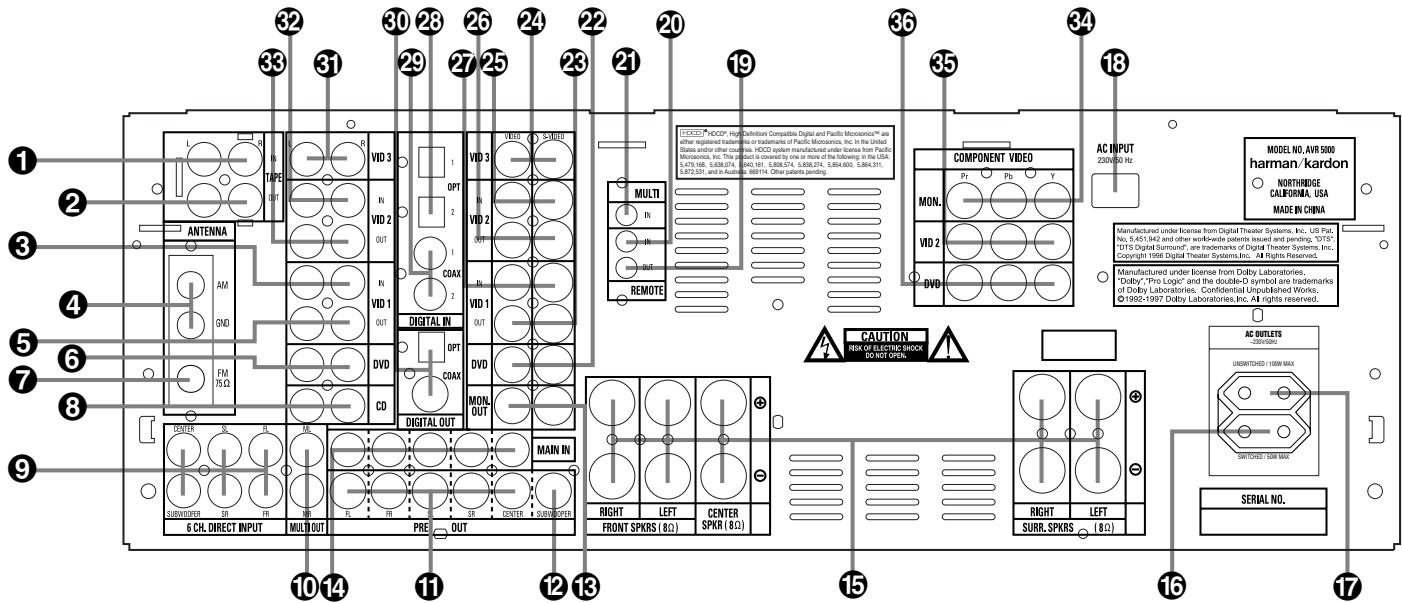

- 1 Tape Inputs
- 2 Tape Outputs
- 3 Video 1 Audio Inputs
- 4 AM Antenna
- 5 Video 1 Audio Outputs
- 6 DVD Audio Inputs
- 7 FM Antenna
- 8 CD Inputs
- 9 6-Channel Direct Inputs
- 10 Multiroom Outputs
- 11 Preamp Outputs
- 12 Subwoofer Output
- 13 Video Monitor Outputs
- 14 Amplifier Inputs

- 15 Speaker Outputs
- 16 Switched AC Accessory Outlet
- 17 Unswitched AC Accessory Outlet
- 18 AC Power Cord
- 19 Remote IR Output
- 20 Remote IR Input
- 21 Multiroom IR Input
- 22 DVD Video Inputs
- 23 Video 1 Video Outputs
- 24 Video 3 Video Inputs
- 25 Video 2 Video Inputs
- 26 Video 2 Video Outputs
- 27 Video 1 Video Inputs
- 28 Optical Digital Inputs

- 29 Coaxial Digital Inputs
- 30 Digital Audio Outputs
- 31 Video 3 Audio Inputs
- 32 Video 2 Audio Inputs
- 33 Video 2 Audio Outputs
- 34 Component Video Outputs
- 35 Video 2 Component Video Inputs
- 36 DVD Component Video Inputs

1 Tape Inputs: Connect these jacks to the **PLAY/OUT** jacks of an audio recorder.

2 Tape Outputs: Connect these jacks to the **RECORD/INPUT** jacks of an audio recorder.

3 Video 1 Audio Inputs: Connect these jacks to the **PLAY/OUT** audio jacks on a VCR or other video source.

4 AM Antenna: Connect the AM loop antenna supplied with the receiver to these terminals. If an external AM antenna is used, make connections to the **AM** and **GND** terminals in accordance with the instructions supplied with the antenna.

5 Video 1 Audio Outputs: Connect these jacks to the **RECORD/INPUT** audio jacks on a VCR or any other Audio recorder.

6 DVD Audio Inputs: Connect these jacks to the analog audio jacks on a DVD or other video source.

7 FM Antenna: Connect the supplied indoor or an optional external FM antenna to this terminal.

8 CD Inputs: Connect these jacks to the analog output of a compact disc player or CD changer.

9 6-Channel Direct Inputs: If an external digital audio decoder is used, connect the outputs of that decoder to these jacks.

10 Multiroom Outputs: Connect these jacks to an optional audio power amplifier to listen to the source selected by the multiroom system in a remote room.

11 Preamp Outputs: These jacks may be connected to an external power amplifier.

12 Subwoofer Output: Connect this jack to the line-level input of a powered subwoofer. If an external subwoofer amplifier is used, connect this jack to the subwoofer amplifier input.

Rear Panel Connections

13 Video Monitor Outputs: Connect these jacks to the composite and/or S-Video input of a TV monitor or video projector to view the on-screen menus and the output of any video source selected by the receiver's video switcher.

14 Amplifier Inputs: When the jumper pins that link the **Preamp Outputs 11** with these inputs are removed, these jacks may be used to connect any external 5.1 channel source (or 2 channel source, if only Main Inputs are used), e.g. processors, to the internal amplifiers. (See page 18 for more information on using these connections.)

15 Speaker Outputs: Connect these outputs to the matching + or – terminals on your speakers. When making speaker connections always make certain to maintain correct polarity by connecting the red (+) terminals on the AVR5000 to the red (+) terminals on the speakers and the black (–) terminals on the AVR5000 to the black (–) terminals on the speakers. See page 15 for more information on speaker polarity.

16 Switched AC Accessory Outlet: This outlet may be used to power any device that you wish to have turn on when the unit is turned on with the **System Power Control** switch **2**.

17 Unswitched AC Accessory Outlet: This outlet may be used to power any AC device. The power will remain on at this outlet regardless of whether the AVR5000 is on or off (in Standby), provided that the **Main Power** switch **1** is on.

Note: The total power consumption of all devices connected to the accessory outlets should not exceed 100 watts from the **Unswitched Outlet 17** and 50 W from the **Switched Outlet 16**.

18 AC Power Cord: Connect the AC plug to an unswitched AC wall outlet.

19 Remote IR Output: This connection permits the IR sensor in the receiver to serve other remote controlled devices. Connect this jack to the "IR IN" jack on Harman Kardon or other compatible equipment.

20 Remote IR Input: If the AVR5000's front-panel IR sensor is blocked due to cabinet doors or other obstructions, an external IR sensor may be used. Connect the output of the sensor to this jack.

21 Multiroom IR Input: Connect the output of an IR sensor in a remote room to this jack to operate the AVR5000's multiroom control system.

22 DVD Video Inputs: Connect these jacks to the composite or S-Video output jacks on a DVD player or other video source.

23 Video 1 Video Outputs: Connect these jacks to the **RECORD/INPUT** composite or S-Video jack on a VCR.

24 Video 3 Video Inputs: Connect these jacks to the **PLAY/OUT** composite or S-Video jacks on any video source.

25 Video 2 Video Inputs: Connect these jacks to the **PLAY/OUT** composite or S-Video jacks on a second VCR or other video source.

26 Video 2 Video Outputs: Connect these jacks to the **RECORD/INPUT** composite or S-Video jacks on a second VCR.

27 Video 1 Video Inputs: Connect these jacks to the **PLAY/OUT** composite or S-Video jacks on a VCR or other video source.

28 Optical Digital Inputs: Connect the optical digital output from a DVD player, HDTV receiver, LD player, MD player or CD player to these jacks. The signal may be either a Dolby Digital signal, a DTS signal or a standard PCM digital source.

29 Coaxial Digital Inputs: Connect the coaxial digital output from a DVD player, HDTV receiver, LD player, MD player or CD player to these jacks. The signal may be either a Dolby Digital signal, a DTS signal or a standard PCM digital source. Do not connect the RF digital output of an LD player to these jacks.

30 Digital Audio Outputs: Connect these jacks to the matching digital input connector on a digital recorder such as a CD-R or MiniDisc recorder.

31 Video 3 Audio Inputs: Connect these jacks to the **PLAY/OUT** audio jacks on any audio or video source.

32 Video 2 Audio Inputs: Connect these jacks to the **PLAY/OUT** audio jacks on a VCR or other video source.

33 Video 2 Audio Outputs: Connect these jacks to the **RECORD/INPUT** audio jacks on a VCR or any Audio recorder.

Note: Either the Video or S-Video output of any S-Video source must be connected to the AVR5000, not both in parallel, otherwise the video may be disturbed or its performance be adversely effected.

34 Component Monitor Outputs: Connect these outputs to the component video inputs of a video projector or monitor. When a source connected to one of the two **Component Video Inputs 35/36** is selected the signal will be sent to these jacks.

35 Video 2 Component Video Inputs: Connect the Y/Pr/Pb component video outputs of a set top converter box or other video source to these jacks.

36 DVD Component Video Inputs: Connect the Y/Pr/Pb component video outputs of a DVD player to these jacks.

Note: All component inputs/outputs can be used for RGB signals too, in the same way as described for the Y/Pr/Pb signals, then connected to the jacks with the corresponding color. RGB connection is not possible if the source outputs a separate sync signal.

Main Remote Control Functions

- 1 Power On Button
- 2 IR Transmitter Window
- 3 Program/SPL Indicator
- 4 Power Off Button
- 5 Input Selectors
- 6 AVR Selector
- 7 AM/FM Tuner Select
- 8 Learn Button
- 9 Test Button
- 10 Sleep Button
- 11 Surround Mode Selector
- 12 Night Mode
- 13 Channel Select Button
- 14 ▲/▼ Buttons
- 15 ◀ Button
- 16 Set Button
- 17 Digital Select
- 18 Numeric Keys
- 19 Tuner Mode
- 20 Direct Button
- 21 Tuning Up/Down
- 22 OSD Button
- 23 Macro Buttons
- 24 Transport Controls
- 25 Skip Up/Down Buttons
- 26 RDS Select Button
- 27 Preset Up/Down
- 28 Clear Button
- 29 Memory Button
- 30 Delay/Prev. Ch.
- 31 ▶ Button
- 32 Speaker Select
- 33 Multiroom
- 34 Volume Up/Down
- 35 TV/Video Selector
- 36 SPL Indicator Select
- 37 6-Channel Direct Input
- 38 Mute
- 39 EzSet Sensor Microphone
- 40 Light Button

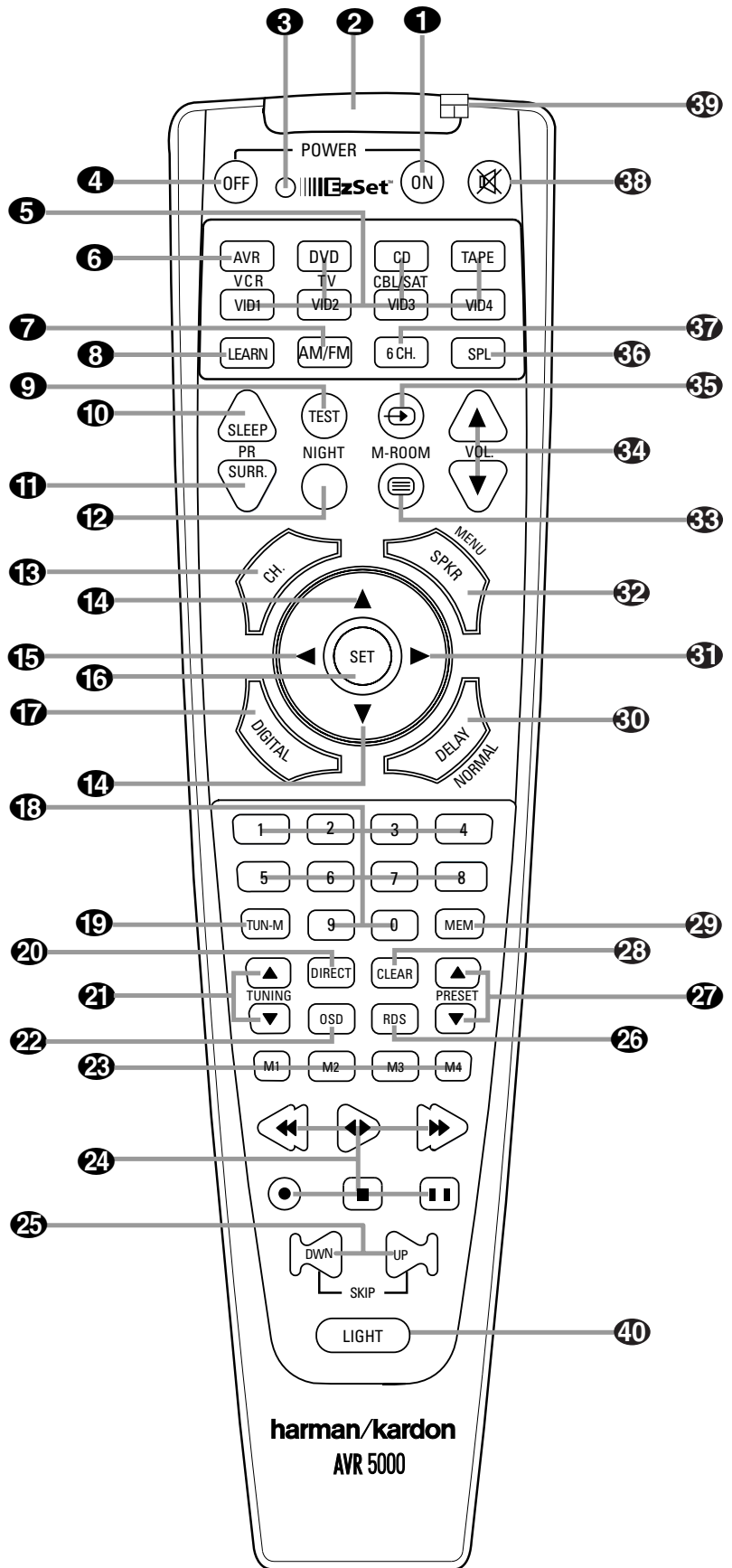

NOTE: The function names shown here are each button's feature when used with the AVR. Most buttons have additional functions when used with other devices. See page 44-45 for a list of these functions.

Main Remote Control Functions

IMPORTANT NOTE: The AVR5000's remote may be programmed to control up to seven devices, including the AVR5000. Before using the remote, it is important to remember to press the **Input Selector** button **5** that corresponds to the unit you wish to operate. In addition, the AVR5000's remote is shipped from the factory to operate the AVR5000 and most Harman Kardon CD or DVD players and cassette decks. The remote is also capable of operating a wide variety of other products using the control codes that are part of the remote or by learning commands from other remotes. Before using the remote with other products, follow the instructions on pages 39 to program the proper codes for the products in your system.

It is also important to remember that many of the buttons on the remote take on different functions, depending on the product selected using the Input Selectors. The descriptions shown here primarily detail the functions of the remote when it is used to operate the AVR5000. (See page 44 for information about alternate functions for the remote's buttons.)

1 Power On Button: Press this button to turn on the power to a device selected by pressing one of the **Input Selectors 5** (except Tape).

2 IR Transmitter Window: Point this window towards the AVR5000 when pressing buttons on the remote to make certain that infrared commands are properly received.

3 Program/SPL Indicator: This three-color indicator is used to guide you through the process of programming the remote or learning commands from a remote into the AVR 5000's remote code memory and it is also used as a level indicator when using the remote's EzSet capabilities. (See page 24 for more information on setting output levels, and see page 39 for information on programming the remote.)

4 Power Off Button: Press this button to place the AVR5000 or a selected device unit in the Standby mode. Note that when the AVR5000 is switched off this will turn off the main room functions, but if the Multiroom system is activated, it will continue to function.

5 Input Selectors: Pressing one of these buttons will perform three actions at the same time. First, if the AVR is not turned on, this will power up the unit. Next, it will select the source shown on the button as the input to the AVR. Finally, it will change the remote control so that it controls the device selected. After pressing one of these buttons you must press the **AVR Selector** button **6** again to operate the AVR's functions with the remote.

6 AVR Selector: Pressing this button will switch the remote so that it will operate the AVR's functions. If the AVR is in the Standby mode, it will also turn the AVR on.

7 AM/FM Tuner Select: Press this button to select the AVR's tuner as the listening choice. Pressing this button when the tuner is in use will select between the AM and FM bands.

8 Learn Button: Press this button to begin the process of "learning" the codes from another product's remote into the AVR5000's remote. (See page 40 for more information on using the remote's learning function.)

9 Test Tone: Press this button to begin the sequence used to calibrate the AVR5000's output levels. (See page 24 for more information on calibrating the AVR5000.)

10 Sleep Button: Press this button to place the unit in the Sleep mode. After the time shown in the display, the AVR5000 will automatically go into the Standby mode. Each press of the button changes the time until turn-off in the following order:

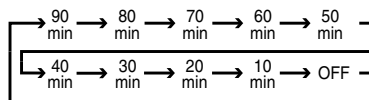

Hold the button pressed for two seconds to turn off the Sleep mode setting.

Note that this button is also used to change channels on your TV, VCR and SAT receiver when selected.

11 Surround Mode Selector: Press this button to begin the process of changing the surround mode. After the button has been pressed, use the **▲/▼** buttons **14** to select the desired surround mode (See page 29 for more information). Note that this button is also used to tune channels when the TV, VCR and SAT receiver is selected using the **Input Selector 5**.

12 Night Mode: Press this button to activate the Night mode. This mode is available only with Dolby Digital encoded digital sources, and it preserves dialog (center channel) intelligibility at low volume levels (See page 31 for more information).

13 Channel Select Button: This button is used to start the process of setting the AVR5000's output levels with an external source. Once this button is pressed, use the **▲/▼** buttons **14** to select the channel being adjusted, then press the **Set** button **16**, followed by the **▲/▼** buttons again, to change the level setting. (See page 32 for more information.)

14 ▲/▼ Buttons: These are multi-purpose buttons. They will be used most frequently to select a surround mode. To change the surround mode, first press the **SURR/CH ▼** button **11**. Next press these buttons to scroll up or down through the list of surround modes that appear in the **Main Information Display 25**. These buttons are also used to increase or decrease output levels when configuring the unit with either the internal test tone or an external source. They are also used to enter delay time settings after the **Delay** button **30** has been pressed.

When the AVR5000 remote is being programmed for the codes of another device, these buttons are also used in the "Auto Search" process (See page 39 for more information on programming the remote.)

15 ◀ Button: This button is used to change the menu selection or setting during some of the setup procedures for the AVR.

16 Set Button: This button is used to enter settings into the AVR5000's memory. It is also used in the setup procedures for delay time, speaker configuration and channel output level adjustment.

17 Digital Select: Press this button to assign one of the digital inputs **28 29 13 15** to a source. (See page 30 for more information on using digital inputs.)

18 Numeric Keys: These buttons serve as a ten-button numeric keypad to enter tuner preset positions. They are also used to select channel numbers when **TV**, **VCR** or **Sat** receiver has been selected on the remote, or to select track numbers on a CD, DVD or LD player, depending on how the remote has been programmed.

19 Tuner Mode: Press this button when the tuner is in use to select between automatic tuning and manual tuning. When the button is pressed so that the **AUTO** indicator **X** goes out, pressing the **Tuning** buttons **21 8 E** will move the frequency up or down in single-step increments. When the FM band is in use and the **AUTO** indicator **X** is on, pressing this button will change to monaural reception making even weak stations audible. (See page 33 for more information.)

Main Remote Control Functions

20 Direct Button: Press this button when the tuner is in use to start the sequence for direct entry of a station's frequency. After pressing the button simply press the proper **Numeric Keys 18** to select a station (See page 33 for more information on the tuner).

21 Tuning Up/Down: When the tuner is in use, these buttons will tune up or down through the selected frequency band. If the **Tuner Mode** button **19** has been pressed or the **Band** button **12** on the front panel was held pressed so that the **AUTO** indicator **X** is illuminated, pressing either of the buttons will cause the tuner to seek the next station with acceptable signal strength for quality reception. When the **AUTO** indicator **X** is NOT illuminated, pressing these buttons will tune stations in single-step increments. (See page 33 for more information.)

22 OSD Button: Press this button to activate the On Screen Display (OSD) system used to set up or adjust the AVR5000's parameters.

23 Macro Buttons: Press these buttons to store or recall a "Macro", which is a pre-programmed sequence of commands stored in the remote. (See page 41 for more information on storing and recalling macros.)

24 Transport Buttons: These buttons do not have any functions for the AVR, but they may be programmed for the forward/reverse play operation of a wide variety of CD or DVD players, and audio or video- cassette recorders. (See page 39 for more information on programming the remote.)

25 Skip Up/Down Buttons: These buttons do not have a direct function with the AVR5000, but when used with a compatibly programmed CD or DVD player/changer they will change the tracks on the disc currently being played.

26 RDS Select Button: Press this button to display the various messages that are part of the RDS data system of the AVR5000's tuner. (See page 34 for more information on RDS).

27 Preset Up/Down: When the tuner is in use, press these buttons to scroll through the stations programmed into the AVR5000's memory. When CD or DVD is selected using the **Input Selector** button **5**, these buttons may function as Slow Fwd/Rev (DVD) or "+10" (CD).

28 Clear Button: Press this button to clear incorrect entries when using the remote to directly enter a radio station's frequency.

29 Memory Button: Press this button to enter a radio station into the AVR5000's preset memory. After pressing the button the **MEMORY** indicator **U** will flash; you then have five seconds to enter a preset memory location using the **Numeric Keys 18**. (See page 33 for more information.)

30 Delay/Prev Ch.: Press this button to begin the process for setting the delay times used by the AVR5000 when processing surround sound. After pressing this button, the delay times are entered by pressing the **Set** button **16** and then using the **▲/▼** buttons **14** to change the setting. Press the Set button again to complete the process. (See page 23 for more information.)

31 ► Button: Press this button to change a setting or selection when configuring many of the AVR's settings.

32 Speaker Select: Press this button to begin the process of configuring the AVR5000's Bass Management System for use with the type of speakers used in your system. Once the button has been pressed, use the **▲/▼** buttons **14** to select the channel you wish to set up. Press the **Set** button **16** and then select the speaker type (see page 22 for more information.)

33 Multi-Room: Press this button to activate the Multiroom system or to begin the process of changing the input or volume level for the second zone. (See page 38 for more information on the Multiroom system.)

34 Volume Up/Down: Press these buttons to raise or lower the system volume.

35 TV/Video Button: This button does not have a direct function on the AVR 5000, but when used with a compatibly programmed VCR, DVD or satellite receiver that has a "TV/Video" function, pressing this button will switch between the output of the player or receiver and the external video input to that player. Consult the Owner's Manual for your specific player or receiver for the details of how it implements this function.

36 SPL Indicator Select: This button activates the AVR5000's EzSet function to quickly and accurately calibrate the AVR 5000's output levels. Press and hold the button for three seconds and then release it. Note that the Test Tone will begin circulating, and the **Program Indicator 3** will change colors. During this sequence, EzSet will automatically adjust the output levels for all channels until they are equal, as shown by the **Program Indicator** lighting green for each channel. (See page 25 for more information on EzSet.)

37 6-Ch. Direct Input: Press this button to select the component connected to the **6-Ch. Direct Input 9** as the source

38 Mute: Press this button to momentarily silence the AVR5000 or TV set being controlled, depending on which device has been selected.

When the AVR5000 remote is being programmed to operate another device, this button is pressed with the **Input Selector** button **5** to begin the programming process. (See page 39 for more information on programming the remote.)

39 EzSet Sensor Microphone: The sensor microphone for the EzSet microphone is behind these slots. When using the remote to calibrate speaker output levels using EzSet, be sure that you do not hold the remote in a way that covers these slots. (See page 25 for more information on using EzSet).

40 Light Button: Press this button to activate the remote's built-in backlight for better legibility of the buttons in a darkened room.

NOTE: As any of the remote buttons pressed is active with the device selected, the corresponding **Selector** button **5 6** will briefly flash red to confirm your selection.

Zone II Remote Control Functions

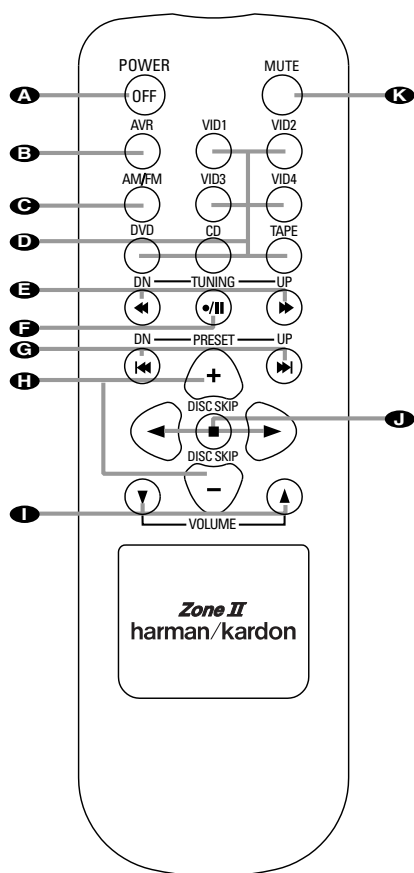

The Zone II remote may be used in either the same room where the AVR5000 is located, or it may be used in a separate room with an optional infrared sensor that is connected to the AVR5000's **Multi IR** input jack ④.

A Power Off: When used in the room where the AVR5000 is located, press this button to place the unit in Standby. When it is used in a remote room with a sensor that is connected to the **Multi IR** jack ④, this button turns the Multi-Room system off.

B AVR Selector: Press this button to turn on the AVR. The input in use when the unit was last on will be selected.

C AM/FM Tuner Select: Press this button to select the Tuner as the input to the Multiroom system. Press it again to change between the AM and FM bands.

D Input Selectors: When the AVR is off, press one of these buttons to turn the unit on and to select a specific input. When the unit is already in use, pressing one of these buttons will change the input.

E Tuning Up/Down – Fast Play: These buttons may be used to change the frequency of the tuner. These buttons may also control the Fast Play or Fast Reverse functions of compatible Harman Kardon CD, DVD or cassette decks in the same room, or from a remote room when an IR link is connected to the AVR 5000.

F Record/Pause: Press this button to activate the Record or Pause function on compatible Harman Kardon CD, DVD or Cassette Deck products.

G Preset Up/Down – Track Skip: When the AVR's tuner is selected as the input source, these buttons will move up or down through the list of stations that have been stored in the preset memory. When a CD or DVD player is selected, these buttons activate the forward or reverse track or chapter skip functions.

H Disc Skip: Press this button to change discs on compatible Harman Kardon CD or DVD changers.

I Volume Up/Down: When used in the room where the AVR5000 is located, press this button to raise or lower the volume in that room. When it is used in a remote room with a sensor that is connected to the **Multi IR** Jack ④, this button will raise or lower the volume in the remote room.

J Play Forward/Reverse/Stop: Press these buttons to control compatible Harman Kardon CD, DVD or cassette players.

Mute: When used in the room where the AVR5000 is located, press this button to temporarily silence the unit. When it is used in a remote room with a sensor that is connected to the **Multi IR** Jack ④, this button will temporarily silence the feed to the remote room only. Press the button again to return to the previous volume level.

Important Note: No matter in which room the Zone II remote is used, as with the main remote it is important to remember to press the **Input Selector** button **D** that corresponds to the unit you wish to operate.

- A** Power Off
- B** AVR Selector
- C** AM/FM Tuner Select
- D** Input Selectors
- E** Tuning Up/Down – Fast Play
- F** Record/Pause
- G** Preset/Track Skip
- H** Disc Skip
- I** Volume Up/Down
- J** Play Forward/Reverse/Stop
- M** Mute

NOTE: The Zone II remote may be used in either the same room where the AVR5000 is located, or it may be used in a separate room with an optional infrared sensor that is connected to the AVR5000's **Multi IR** input jack ④. When it is used in the same room as the AVR5000, it will control the functions of the AVR5000 or any compatible Harman Kardon products in that room. When it is used in a separate room via a sensor connected to the **Multi IR** Jack ④, the buttons for power, input source, volume and

mute will control the source and volume for the second zone, as connected to the Multi Out Jacks ⑩. (See page 38 for complete information on using the Multiroom system.)

Installation and Connections

After unpacking the unit, and placing it on a solid surface capable of supporting its weight, you will need to make the connections to your audio and video equipment.

Audio Equipment Connections

We recommend that you use high-quality interconnect cables when making connections to source equipment and recorders to preserve the integrity of the signals.

When making connections to audio source equipment or speakers it is always a good practice to unplug the unit from the AC wall outlet. This prevents any possibility of accidentally sending audio or transient signals to the speakers that may damage them.

1. Connect the analog output of a CD player to the **CD** inputs **8**.

NOTE: When the CD player has both fixed and variable audio outputs it is best to use the fixed output unless you find that the input to the receiver is so low that the sound is noisy, or so high that the signal is distorted.

2. Connect the analog Play/Out jacks of a cassette deck, MD, CD-R or other audio recorder to the **Tape Input** jacks **1**. Connect the analog Record/In jacks on the recorder to the **Tape Output** jacks **2** on the AVR5000.

3. Connect the output of any digital sources to the appropriate input connections on the AVR5000 front or rear panel. Note that the **Optical** and **Coaxial** digital inputs **28 29 13 15** may be used with a Dolby Digital or DTS source or the output of a conventional CD, MD or LD player's PCM (S/P-DIF) output.

4. Connect the **Coaxial or Optical Digital Outputs** **30** on the rear panel of the AVR to the matching digital input connections on a CD-R or MiniDisc recorder.

5. Assemble the AM Loop Antenna supplied with the unit as shown below. Connect it to the **AM** and **GND** screw terminals **4**.

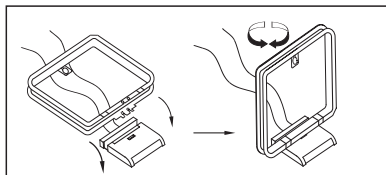

6. Connect the supplied FM antenna to the **FM (75 ohm)** connection **7**. The FM antenna may be an external roof antenna, an inside powered or wire lead antenna or a connection from a cable system. Note that if the antenna or connection uses 300-ohm twin-lead cable, you must use a 300-ohm-to-75-ohm adapter to make the connection.

7. Connect the front, center and surround speaker outputs **15** to the respective speakers.

To assure that all the audio signals are carried to your speakers without loss of clarity or resolution, we suggest that you use high-quality speaker cable. Many brands of cable are available and the choice of cable may be influenced by the distance between your speakers and the receiver, the type of speakers you use, personal preferences and other factors. Your dealer or installer is a valuable resource to consult in selecting the proper cable.

Regardless of the brand of cable selected, we recommend that you use a cable constructed of fine, multistrand copper with an area greater than 2 mm².

Cable with an area of 1.5 mm² may be used for short runs of less than 4 m. We do not recommend that you use cables with an area less than 1mm² due to the power loss and degradation in performance that will occur.

Cables that are run inside walls should have the appropriate markings to indicate listing with UL, CSA or other appropriate testing agency standards. Questions about running cables inside walls should be referred to your installer or a licensed electrical contractor who is familiar with the applicable local building codes in your area.

When connecting wires to the speakers, be certain to observe proper polarity. Remember to connect the "negative" or "black" wire to the same terminal on both the receiver and the speaker. Similarly, the "positive" or "red" wire should be connected to like terminals on the AVR5000 and speaker.

NOTE: While most speaker manufacturers adhere to an industry convention of using black terminals for negative and red ones for positive, some manufacturers may vary from this configuration. To assure proper phase and optimal performance, consult the identification plate on your speaker or the speaker's manual to verify polarity. If you do not know the polarity of your speaker, ask your dealer for advice before proceeding, or consult the speaker's manufacturer.

We also recommend that the length of cable used to connect speaker pairs be identical. For example, use the same length piece of cable to connect the front-left and front-right or surround-left and surround-right speakers, even if the speakers are a different distance from the AVR5000.

8. Connections to a subwoofer are normally made via a line level audio connection from the **Subwoofer Output** **12** to the line-level input of a subwoofer with a built-in amplifier. When a passive subwoofer is used, the connection first goes to a power amplifier, which will be con-

nected to one or more subwoofer speakers. If you are using a powered subwoofer that does not have line-level input connections, follow the instructions furnished with the speaker for connection information.

Note: Speaker sets with two front satellites and a passive subwoofer must be connected to the front speaker outputs **14** only rather than to the **Subwoofer Output** **12**.

Video Equipment Connections

Video equipment is connected in the same manner as audio components. Again, the use of high-quality interconnect cables is recommended to preserve signal quality. To ensure best video performance S-Video sources should be connected to the AVR5000 only with their S-Video In/Outputs, not with their composite video connectors too.

1. Connect a VCR's audio and video Play/Out jacks to the **Video 1** or **Video 2 In** jacks **3 25 27 32** on the rear panel. The Audio and Video Record/In jacks on the VCR should be connected to the **Video 1** or **Video 2 Out** jacks **5 23 25 33** on the AVR5000.

2. Connect the analog audio and video outputs of a satellite receiver, cable TV converter or television set or any other video source to the **Video 2** **25 32** (if not in use) or **Video 3** **24 31** jacks.

3. Connect the analog audio and video outputs of a DVD or laser disc player to the **DVD** jacks **6 22**.

4. Connect the digital audio outputs of a CD, MD or DVD player, satellite receiver, cable box or HDTV converter to the appropriate **Optical** or **Coaxial Digital Inputs** **28 29 13 15**.

5. Connect the **Video Monitor Out** **18** jacks on the receiver to the composite and S-Video input of your television monitor or video projector.

6. If your DVD player and monitor both have component video connections, connect the component outputs of the DVD player to the **DVD Component Video Inputs** **36**. Note that even when component video connections are used the audio connections must still be made to either the analog **DVD Audio Inputs** **6** or any of the **Coaxial** or **Optical Digital Input** jacks **28 29**.

7. If another component video device is available, connect it to the **Video 2 Component Video Input** jacks **35**. The audio connections for this device should be made to either the **Video 2 Input** jacks **32** or any of the **Coaxial** or **Optical Digital Input** jacks **28 29**.

Installation and Connections

8. If the component video inputs are used, connect the **Component Video Output 24** to the component video inputs of your TV, projector or display device.

Video Connection Notes:

- Y/Pr/Pb Component, S-Video or Composite video signals may only be viewed in their native formats and will not be converted to the other formats. But the OSD can be viewed on the TV screen in any case, with Video or S-Video input selected on the TV.
- When the component video jacks are used, the on-screen menus will not be visible. You must switch to the standard composite or S-Video input on your TV to view those menus.
- The AVR 5000's component video system is designed for standard video rate video from DVD players and similar devices. While it may operate with high definition signals, the video quality may be slightly less than with a direct connection between the DVD and your TV.
- All component inputs/outputs can be used for RGB signals too, in the same way as described for the Y/Pr/Pb signals, then connected to the jacks with the corresponding color. But this is only true as long as only the three RGB lines are used and not any sync signal is output separately from the source.

SCART A/V Connections

For the connections described above your video device needs RCA (cinch) connectors or/and S-Video connectors for all Audio and Video signals: Any normal video device (Not SVHS or High 8) for only playback needs 3 RCA jacks, VCRs for record and playback even 6 RCA jacks. Any S-Video device (SVHS, High 8) needs 2 RCA (Audio) and 1 S-Video jack (Video), if it's a playback unit, or 4 RCA (Audio In/Out) and 2 S-Video (Video In/Out) jacks, if it's a recording VCR.

Many european video devices are equipped with RCA (Cinch) or S-Video jacks only partially, not for all audio and video in/outputs needed as described above, but with a so called Scart or Euro-AV connector (almost rectangular jack with 21 pins, see drawings on next page).

In that case the following Scart to Cinch adapters or cables are needed:

- Units for playback, such as satellite receivers, camcorders, DVD or LD players, need an adapter from Scart to 3 RCA plugs, see fig. 1 (normal video devices) or from Scart to 2 RCA+1 S-Video plugs, see fig. 4 (S-Video devices).
- HiFi VCRs need an adapter from Scart to 6 RCA plugs, see fig. 2 (normal video), or from Scart to 4 Audio+2S-Video jacks, see fig. 5 (S-Video VCR). Read carefully the instruction attached to the adapter to find which of the six plugs is used for the record signal to the VCR (connect with the AVR's Out jacks) and for the playback signal from the VCR (connect with the AVR's In jacks). Do not misconnect Audio and Video signals. Don't hesitate to consult your dealer, if you are uncertain.
- If you use only normal video devices the TV monitor needs an adapter from 3 RCA plugs to Scart (fig. 3) only. If also S-Video devices are used an adapter from 2 RCA+1S-Video plugs to Scart is needed additionally (fig. 6), connected to the SCART input on your TV that is provided for S-Video.

Note that only the video plugs (the "yellow" cinch plug in fig. 3 and the S-Video plug in fig. 6) must be connected to the **TV Monitor Output 15**, and the volume on the TV must be reduced to minimum.

Important Note for Adapter Cables:

If the cinch connectors of the adapter you'll use are labeled, connect the Audio and Video "In" plugs with the corresponding Audio and Video "In" jacks on the AVR5000 (and with a VCR connect the "Out" plugs to the "Out" jacks on the AVR). Note that with some adapter types it may be just turned around: If no signal is audible/ visible when the VCR is playing connect the "Out" plugs to the "In" jacks on the AVR and turned around. If the adapter plugs are not labeled in that way, pay attention to the signal flow directions as shown in the diagrams above and in the instruction attached to the adapter. If uncertain, don't hesitate to consult your dealer.

Important Notes for S-Video connections:

1. Only the S-Video In/Out of S-Video devices must be connected to the AVR, NOT both, normal video and S-Video In/Outputs (except the TV, see item below).
2. Like most common AV units the AVR5000 does not convert the Video signal to S-Video or vice versa. Thus both connections must be made from the AVR5000 to the TV if both, Video and S-Video sources, are used, and the appropriate input on the TV must be selected.

Installation and Connections

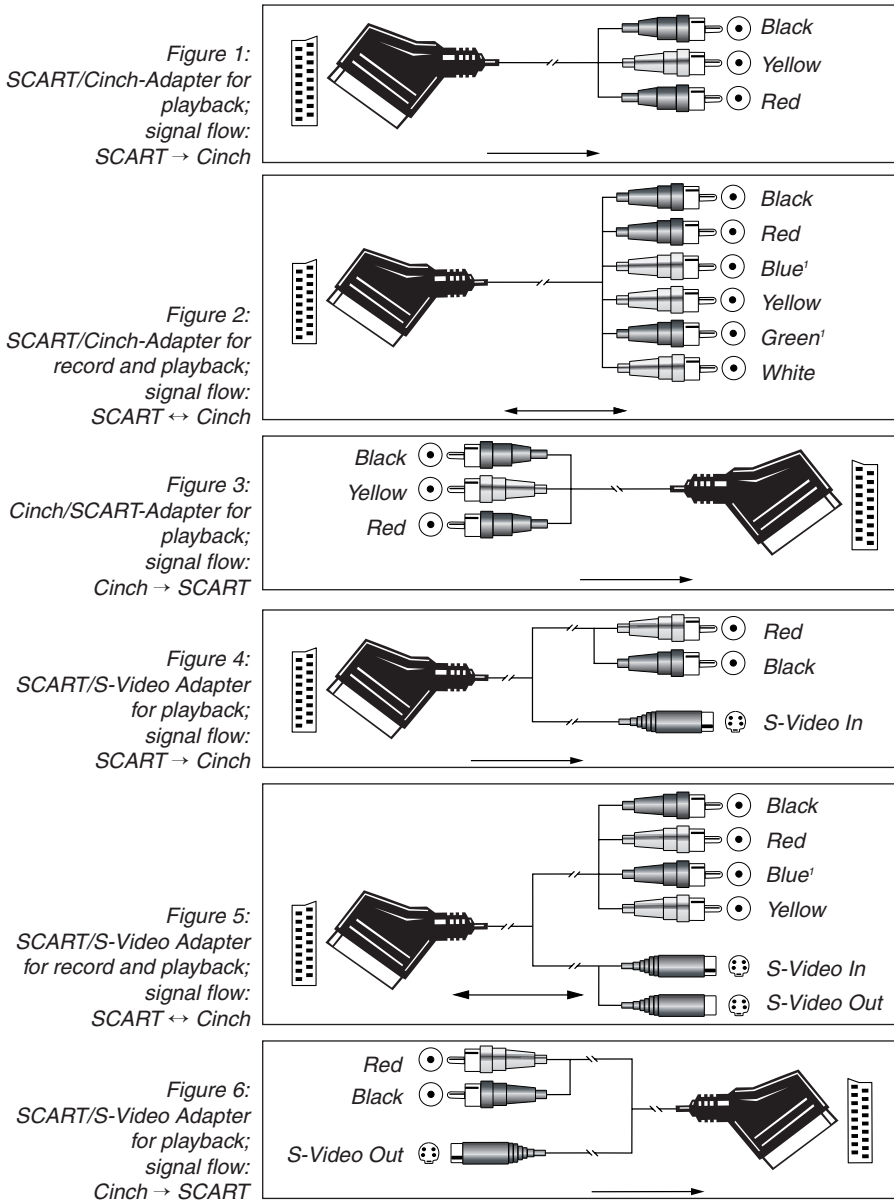

¹ Also other colours possible, e.g. brown and grey.

Important Note for the Use of SCART-Cinch Adapters:

When video sources are connected to the TV directly with a SCART cable, specific control signals apart from Audio/Video signals will be fed to the TV. These specific signals are: With all video sources, the signal for automatic input selection that switches the TV automatically to the appropriate input as soon as the video source is started. And with DVD players, the signals automatically turning the TV to 16:9 format (with switchable 4:3 TVs) and turning the RGB video decoder of the TV on or off, depending on the DVD player's setting. With any adapter cable, these control signals will be lost and the appropriate setting of the TV must be made manually.

Note for RGB signal with SCART:

If you use a unit providing RGB signals on a SCART output (as e.g. most DVD players do) and you want to use that RGB signal, this SCART output must be connected directly to your TV. Although the AVR 5000 RDS can switch three-way video signals (like component signals Y/Pb/Pr), most TVs need separate sync signals for RGB (also with SCART) that cannot be switched and provided by the AVR 5000. RGB signals can be pathed through the AVR5000 only when no separate sync signal is needed (see 4th "Video Connection Note" on page 16).

Installation and Connections

System and Power Connections

The AVR5000 is designed for flexible use with multiroom systems, external control components and power amplifiers.

Main Room Remote Control Extension

If the receiver is placed behind a solid or smoked glass cabinet door, the obstruction may prevent the remote sensor from receiving commands. In this event, the remote sensor of any Harman Kardon or other compatible device, not covered by the door, or an optional remote sensor may be used. Connect the **Remote IR Output** of that device or the output of the remote sensor to the **Remote IR Input** jack 20.

If other components are also prevented from receiving remote commands, only one sensor is needed. Simply use this unit's sensor or a remote eye by running a connection from the **Remote IR Output** jack 19 to the **Remote IR Input** jack on Harman Kardon or other compatible equipment.

NOTE: All remotely controlled components must be linked together in a daisy chain. Connect the **IR OUT** jack of one unit to the **IR IN** of the next to establish this chain.

Multiroom IR Link

The key to remote room operation is to link the remote room to the AVR5000's location with wire for an infrared receiver and speakers or an amplifier. The remote room IR receiver (this can be an optional IR receiver or any other remotable Harman Kardon device in the remote room with IR sensor integrated) should be connected to the AVR5000 via standard coaxial cable. Connect the **Remote IR Output** of the device or of the optional sensor with the **Multiroom IR Input** jack 21 on the AVR5000's rear panel.

If other Harman Kardon compatible source equipment is part of the main room installation, the **Remote IR Output** jack 19 on the rear panel should be connected to the IR IN jack on that source device. This will enable the remote room location to control source equipment functions.

Multiroom Audio Connections

Depending on the distance from the AVR5000 to the remote room, two options (A and B) are available for audio connection:

Option 1: Use high-quality, shielded stereo audio interconnect cable with phono plugs on both ends from the AVR5000's location to the remote room. At the remote room, connect the interconnect cable to a stereo power amplifier. The amplifier will be connected to the room's speakers. No volume control is required, as the AVR5000 and the remote IR link will provide that function. At the AVR5000, plug the audio interconnect cables into the **Multi-Room Output** jacks 10 on the AVR5000's rear panel.

Option 2: Place the amplifier that will provide power to the remote location speakers in the same room as the AVR5000, and connect the **Multiroom Output** jacks 10 on the rear panel of the AVR to the audio input of the remote room amplifier. Use the appropriate speaker wire to connect the optional power amplifier to the remote speakers. High-quality wire of at least 2.5 mm² is recommended for long multiroom connections.

IMPORTANT NOTE: Any cables run inside walls should carry any certification that is required by the local building and electrical codes. To avoid interference, audio and speaker cables should not be parallel to, or run in the same conduits or path with, AC cables. If you have any questions about multiroom wiring, consult your dealer, custom installer or low-voltage electrical contractor.

External Audio Power Amplifier Connections

If desired, the AVR 5000 may be connected to optional, external audio power amplifiers or used with equalizers or speaker systems that require connection between the preamp and amplifier sections of a receiver.

To make these connections, remove the jumpers that connect the **Preamp Out** jacks 11 and **Amplifier In** jacks 14 for the channels to be used with external devices. Store the jumpers in a safe place so that the AVR may be used in its normal mode at a future date, if desired.

When an external amplifier is used, connect the **Preamp Out** jacks 11 to the inputs on the amplifier. When an equalizer or speaker processor is used, connect the **Preamp Out** jacks 11 to the inputs of the processor, and connect the outputs of the processor back to the **Amplifier In** jacks 14 on the AVR. Note that when external amplifiers or devices are used, volume is still controlled by the AVR, although additional volume controls on the external device may affect volume and output levels from the AVR.

External Audio Decoder Connection

To provide for ultimate flexibility, the AVR5000 may be used in conjunction with optional, external decoders for digital audio systems other than the AVR5000's own built-in Dolby Digital and DTS decoding system or with DVD players having those decoders integrated. If an external decoder is used, connect the output jacks of the decoder to the **6-Channel Direct** inputs 9, making sure to match channels.

These jacks may also be used for connections to devices such as DVD players or High Definition Television (HDTV) sets or decoders that feature built-in digital surround decoders. Although the digital decoding system in the AVR5000 will typically provide audio performance that is superior to other decoders, you may use these jacks to provide an additional 6-channel input for connection to a DVD player or HDTV set with a built-in decoder and discrete 6-channel analog outputs.

AC Power Connections

This unit is equipped with two accessory AC outlets. They may be used to power accessory devices, but they should not be used with high-current draw equipment such as power amplifiers. The total power draw to the **Unswitched** Outlet 17 must not exceed 100 watts, that to the **Switched** Outlet 16 50 watts.

The **Switched** 16 outlet will receive power only when the unit is on completely. This is recommended for devices that have no power switch or a mechanical power switch that may be left in the "ON" position.

NOTE: Many audio and video products go into a Standby mode when they are used with switched outlets, and cannot be fully turned on using the outlet alone without a remote control command.

The **Unswitched** 17 outlet will receive power as long as the unit is plugged into a powered AC outlet and the **Main Power Switch** 1 is on.

Finally, when all connections are complete, plug the power cord into a nonswitched 220-240-volt AC wall outlet. You're almost ready to enjoy the AVR5000!

System Configuration

When all audio, video and system connections have been made, there are a few configuration adjustments that must be made. A few minutes spent to correctly configure and calibrate the unit will greatly add to your listening experience.

Speaker Selection

No matter which type or brand of speakers is used, the same model or brand of speaker should be used for the front-left, center and front-right speakers. This creates a seamless front soundstage and eliminates the possibility of distracting sonic disturbances that occur when a sound moves across mismatched front-channel speakers.

Speaker Placement

The placement of speakers in a multichannel home-theater system can have a noticeable impact on the quality of sound reproduced.

Depending on the type of center-channel speaker in use and your viewing device, place the center speaker either directly above or below your TV, or in the center behind a perforated front-projection screen.

Once the center-channel speaker is installed, position the left-front and right-front speakers so that they are as far away from one another as the center-channel speaker is from the preferred listening position. Ideally, the front-channel speakers should be placed so that their tweeters are no more than 60cm above or below the tweeter in the center-channel speaker.

They should also be at least 0.5 meter from your TV set unless the speakers are magnetically shielded to avoid colourings on the TV screen. Note that most speakers are not shielded, even with complete surround sets only the Center speaker may be.

Depending on the specifics of your room acoustics and the type of speakers in use, you may find that imaging is improved by moving the front-left and front-right speakers slightly forward of the center-channel speaker. If possible, adjust all front loudspeakers so that they are aimed at ear height when you are seated in the listening position.

Using these guidelines, you'll find that it takes some experimentation to find the correct location for the front speakers in your particular installation. Don't be afraid to move things around until the system sounds correct. Optimize your speakers so that audio transitions across the front of the room sound smooth.

Surround speakers should be placed on the side walls of the room, at or slightly behind the listening position. The center of the speaker should face you.

If side-wall mounting is not practical, the speakers may be placed on a rear wall, behind the listening position. The speakers should be no more than two meters behind the rear of the seating area.

Subwoofers produce largely nondirectional sound, so they may be placed almost anywhere in a room. Actual placement should be based on room size and shape and the type of subwoofer used. One method of finding the optimal location for a subwoofer is to begin by placing it in the front of the room, about 15cm from a wall, or near the front corner of the room. Another method is to temporarily place the subwoofer in the spot where you will normally sit, and then walk around the room until you find a spot where the subwoofer sounds best. Place the subwoofer in that spot. You should also follow the instructions of the subwoofer's manufacturer, or you may wish to experiment with the best location for a subwoofer in your listening room.

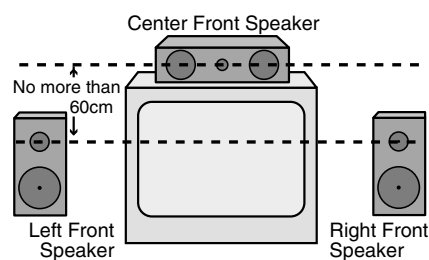

A) Front Channel Speaker Installation with Direct-View TV Sets or Rear-Screen Projectors

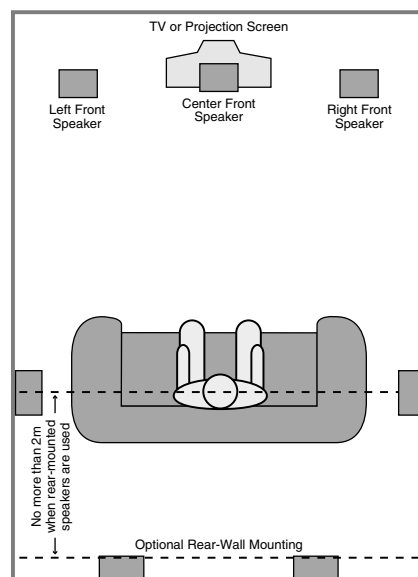

B) The distance between the left and right speakers should be equal to the distance from the seating position to the viewing screen. You may also experiment with placing the left and right speakers slightly forward of the center speaker.

System Configuration

First Turn On and Use of the OSD

Once the speakers have been placed in the room and connected, the remaining steps are to program the system configuration memories. With the AVR5000 two kind of memories are used, those associated individually with the input selected, e.g. surround modes, and others working independently from any input selected like speaker output levels, crossover frequencies or delay times used by the surround sound processor.

You are now ready to power up the AVR5000 to begin these final adjustments.

1. Plug the **Power Cable** **18** into an unswitched AC outlet.
2. Press the **Main Power Switch** **1** in until it latches and the word "OFF" on the top of the switch disappears inside the front panel. Note that the **Power Indicator** **3** will turn amber, indicating that the unit is in the Standby mode.
3. Install the three supplied AAA batteries in the remote as shown. Be certain to follow the (+) and (-) polarity indicators that are on the bottom of the battery compartment.

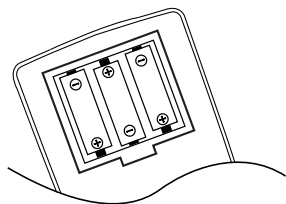

4. Turn the AVR5000 on either by pressing the **System Power Control** **2** or the **Input Source Selector** **11** on the front panel, or via the remote by pressing the **AVR Selector** **6** or any of the **Input Selectors** **5** **7** on the remote. The **Power Indicator** **3** will turn green to confirm that the unit is on, and the **Main Information Display** **25** will also light up.

Using the On-Screen Display

When making the following adjustments, you may find them easier to make via the unit's on-screen display system. These easy-to-read displays give you a clear picture of the current status of the unit and facilitate speaker, delay, input or digital selection you are making.

To view the on-screen displays, make certain you have made a connection from the **Video Monitor Out** jack **15** on the rear panel to the composite or S-Video input of your TV or projector. In order to view the AVR's displays, the correct video input must be selected on your video display.

IMPORTANT NOTE: When viewing the displays on a projection TV it is important that they not be left on the screen for an extended period of time. As with any video display, but particularly with

projectors, constant display of a static image such as these menus or video game images may cause the image to be permanently "burned into" the CRT. This type of damage is not covered by the AVR5000 warranty and may not be covered by the projector TV set's warranty.

The AVR5000 has two on-screen display modes, "Semi-OSD" and "Full-OSD." When making configuration adjustments, it is recommended that the Full-OSD mode be used. This will place a complete status report or option listing on the screen, making it easier to view the available options and make the settings on the screen. The Semi-OSD mode uses one-line displays only.

Note that when the full OSD system is in use, the menu selections are not shown in the **Information Display** **25** **Y**. When the full OSD menu system is used, OSD ON will appear in the **Main Information Display** **Y** and the **OSD Indicator** **M** will illuminate to remind you that a video display must be used.

When the semi-OSD system is used in conjunction with the discrete configuration buttons, the on screen display will show a single line of text with the current menu selection. That selection will also be shown in the **Main Information Display** **Y**.

Selecting the On-Screen display

The full OSD system is always available by pressing the **OSD** button **22**. When this button is pressed the **MASTER MENU** (Figure 1) will appear, and adjustments are made from the individual menus. Note that the menus will remain on the screen for 20 seconds after the latest action was made on the screen menu, then they will "time-out" and disappear from the screen. The time-out may be increased to as much as 50 seconds by going to the **ADVANCED SELECT** menu, and changing the item titled **FULL OSD TIME OUT**.

The semi-OSD system is also available as a system default, although it may be turned off by using the **ADVANCED SELECT** menu. (See page 37). With the semi-OSD system, you may make adjustments directly, by pressing the buttons on the front panel or remote control for the specific parameter to be adjusted as outlined above.

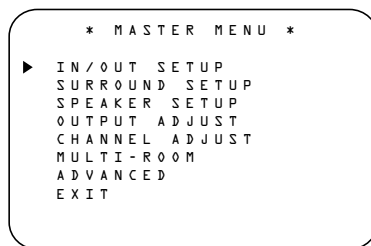

Figure 1

Settings to be Made With Each Input Used

The AVR5000 features an advanced memory system that enables you to establish different configurations for the speaker configuration, digital input and surround mode for each input source. This flexibility enables you to custom tailor the way in which you listen to each source and have the AVR5000 memorize them. This means, for example, that you may associate different surround modes and analog or digital inputs with different sources, or set different speaker configurations with the resultant changes to the bass management system. Once these settings are made, they will automatically be recalled whenever you select an input.

The default settings for the AVR5000, as it is shipped from the factory, have all inputs set for an analog source, with stereo as the surround mode, the front left and right speakers set to "large" (with surround modes other speakers to "small"), and a subwoofer connected. Before using the unit, you will probably want to change these settings for most inputs so that they are properly configured to reflect the use of digital or analog inputs, the type of speakers installed and the surround mode specifics. Remember, since the AVR5000's memory system keeps the settings for each input separate from the other inputs, you will need to make these adjustments for each input used. However, once they are made, further adjustment is only required when system components are changed.

To make this process as quick and as easy as possible, we suggest that you use the full-OSD system with the on-screen menus, and step through each input. Once you have completed the settings for the first input, many settings may be duplicated for the remaining inputs. It is also a good idea to set the configuration data in the order these items are listed in the Main Audio Setup Menu, as some settings require a specific entry in a prior menu item.

The items that follow will describe the individual settings required for each input. Remember that once the settings are made for one input, they must be made for all other input sources in your system.

System Configuration

Input Setup

The first step in configuring the AVR5000 is to select an input. This may be done by pressing the front panel **Input Source Selector** **11** until the desired input's name appears momentarily in the **Main Information Display** **Y**, and the green LED lights next to the input's name in the front panel **Input Indicators** **22**. The input may also be selected by pressing the appropriate Input Selector on the remote control **5 7**.

When using the full-OSD system to make the setup adjustments, press the **OSD** button **22** once so that the **MASTER MENU** (Figure 1) appears. Note that the ► cursor will be next to the **IN/OUT SETUP** line. Press the **Set** button **16** to enter the menu and the **IN/OUT SETUP** menu (Figure 2) will appear on the screen. Press the ◀▶ buttons **15 31** until the desired input name appears in the highlighted video, as well as being indicated in the front panel **Input Indicators** **22** by the green LED next to the desired input name. If the input will use the standard left/right analog inputs, no further adjustment is needed.

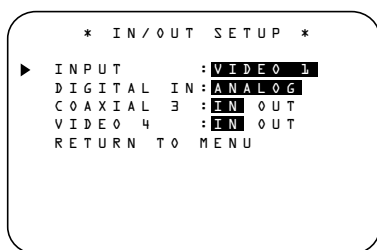

Figure 2

If you wish to associate one of the digital inputs with the selected input source, press the ▼ button **14** on the remote while the **IN/OUT SETUP** menu (Figure 2) is on the screen, and note that the on-screen cursor will drop down to the **DIGITAL IN** line. Press the ◀▶ buttons **15 31** until the name of the desired digital input name appears. To return to the **ANALOG** input, press the buttons until the word analog appears. When the correct input appears, press the ▼ button **14** until the ► cursor appears next to **RETURN TO MENU**, and press the **Set** button **16**.

To change the digital input associated with the input selected at any time using the discrete function buttons and the semi-OSD system, press the **Digital Input Select** button **24 17** on the front panel or the remote. Within five seconds, make your input selection using the **Selector** buttons on the front panel **5** or the ▲/▼ buttons **14** on the remote until the desired digital or analog input is shown in the **Main Information Display** **Y** and in the lower third of the video display connected to the AVR5000. Then press the **Set** button **16** to enter the new digital input assignment.

An exclusive Harman Kardon feature is the ability to switch front panel jacks from their normal use as inputs to output connections so that portable recording devices may easily be connected. The front panel analog **Video 4 Jacks** **16** are normally set as an input for use with camcorders, video games and other portable audio/video products, but they may be switched to an output for connection to portable audio/video recorders. To temporarily switch them to outputs, select the **IN/OUT SETUP** menu. Press the ▼ button **14** until the on-screen ► cursor is pointing to the **VIDEO 4** line. Press the ► button **31** so that the word **OUT** is highlighted. Note that the **Input/Output Status Indicator** **14** between the S and Composite video jacks will turn red, indicating that the analog **Video 4 jacks** **16** are now record outputs.

On the AVR5000, the **Coaxial 3 Digital Jack** **15** is normally an input, but it may also be switched to a digital output for use with CD-R/RW decks, MD recorders or other digital audio recorders. To change the jack to an output, press the ▲/▼ buttons **14** while the **IN/OUT SETUP** menu is on the screen so that the ► cursor is next to **COAXIAL 3**. Then press the ◀▶ buttons **15 31** so that the word **OUT** is highlighted. Note that the **Digital Coax 3 Status Indicator** **14** will turn red, indicating that the jack is now a record output.

Note: A signal will be sent to this jack only when the input selected for use by the AVR5000 is digital. Digital signals will be passed through regardless of their format, and which digital input (optical or coax) they are fed from. However, analog signals are not converted to digital, and the format of the signal (e.g., PCM, Dolby Digital or DTS) may not be changed.

Selection of the Digital Coax 3 jack as an output will remain effective as long as the AVR 5000 is on. However, once the unit is turned off, the jack will revert to its normal use as an input when the unit is turned on again.

Surround Setup

Once the input setup has been completed, the next step for that input is to set the surround mode you wish to use with that input. Since surround modes are a matter of personal taste, feel free to select any mode you wish – you may change it later. The Surround Mode chart on page 28 may help you select the mode best suited to the input source selected. However, to make it easier to establish the initial parameters for the AVR5000, it is best to select Dolby Pro Logic for most analog inputs and Dolby Digital for inputs connected to digital sources. In the case of inputs such as a CD Player, Tape Deck or Tuner, you may wish to set the mode to Stereo, if that is your preferred listening mode for standard stereo sources, where it is unlikely that sur-

round encoded material will be used.

Alternatively, the 5 Channel Stereo or Logic 7 Music mode may also be a good choice for stereo-only source material.

It is easiest to complete the surround setup using the full-OSD on-screen menus. From the main **MASTER MENU** menu (Figure 1), press the ▲/▼ button **14** until the ► cursor is next to the **SURROUND SETUP** menu. Press the **Set** button **16** so that the **SURROUND SETUP** menu (Figure 3 or 4) is on the screen.

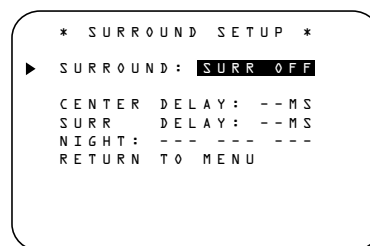

Figure 3

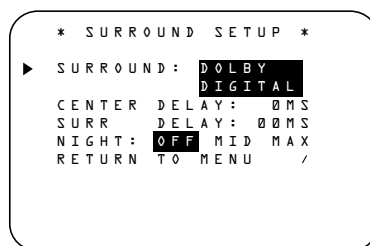

Figure 4

Since the factory default for all inputs is Stereo, the words **SURREOFF** will initially appear in highlighted video (Figure 3) unless another surround mode choice was made with the input just selected. To change the surround mode while the ► cursor is next to the surround line, press the ◀▶ buttons **15 31** until the desired surround mode's name appears in the highlighted video. As the modes are changed, a green LED will also light next to the mode names in the **Surround Mode Indicators** **29** on the front panel.

Note that the data lines next to the items in the screen display will show either numbers or a series of dashes, depending on whether or not the specific parameter is adjustable. For example, the Center Delay and Night Mode items are only adjustable for Dolby Digital, and the Delay Time is only adjusted for Dolby Digital and Dolby Pro Logic. Note, also, that Dolby Digital and DTS will only appear as choices (Figure 4) when a digital input was previously selected. These settings for Delay, Crossover Frequency and Night mode, that are independent of any input selected, will be described in the next chapter on page 23.

System Configuration

Speaker Setup

This menu tells the AVR5000 which type of speakers are in use. This is important as it adjusts the settings that determine which speakers receive low frequency (bass) information. For each of these settings use the **LARGE** setting if the speakers for a particular position are traditional full-range loudspeakers that are capable of reproducing sounds below 100Hz. Use the **SMALL** setting for smaller, frequency-limited satellite speakers that do not reproduce sounds below 100Hz. Note that when "small" front (left and right) speakers are used, a subwoofer is required to reproduce low frequency sounds. If you are in doubt as to which category describes your speakers, consult the specifications in the speakers' owner's manual, or ask your dealer. Remember that the speaker setup must be made individually for each input of the AVR5000.

It is best to select the Dolby Pro Logic mode for making the speaker setup. You should note the surround mode you've associated with the selected input, select the Dolby Pro Logic mode and after the speaker setup was made with that input, reset to the surround mode formerly selected. Note that with the currently selected input all settings will be copied to other surround modes too (as far as possible) and need not be repeated with any other mode (but with each input used).

1. It is easiest to enter the proper settings for the speaker setup through the **SPEAKER SETUP** menu (Figure 5). If that menu is not already on your screen from the prior adjustments, press the **OSD** button **22** to bring up the **MASTER MENU** (Figure 1), and then press the **▼** button **14** twice so that the cursor is on the **SPEAKER SETUP** line. At this point, press the **Set** button **16** to bring up the **SPEAKER SETUP** menu (Figure 5).



Figure 5

2. When the **SPEAKER SETUP** menu appears, the on-screen cursor **▶** will be at the top of the list of speaker positions, pointing toward the **LEFT/RIGHT** line, which sets the configuration for the front left and right speakers. If you wish to make a change to the front speakers configuration, press the **◀▶** buttons **15 31** so that either **LARGE** or **SMALL** appears, matching the appropriate description from the definitions shown above.

When **SMALL** is selected, low frequency front channel sounds will be sent only to the subwoofer output. Note that if you choose this option and there is no subwoofer connected, you will not hear any low frequency sounds from the front channels.

When **LARGE** is selected, a full-range output will be sent to the front left and front right outputs. Depending on the choice made in the **SUBWOOFER** line in this menu (see below), the front left and right bass information may also be directed to a subwoofer.

Important Note: When a speaker set with two front satellites and a passive subwoofer is used, connected to the **front speaker outputs 14**, the fronts must be set for **LARGE**.

3. When you have completed your selection for the front channel, press the **▼** button **14** on the remote to move the cursor to **CENTER**.

4. Press the **◀▶** buttons **15 31** on the remote to select the option that best describes your Center speaker based on the speaker definitions shown on this page.

When **SMALL** is selected, low frequency center channel sounds will be sent to the Fronts, if they are set for **LARGE** and Sub is turned off. When Sub is on, low frequency center channel sounds will be sent to the subwoofer only.

When **LARGE** is selected, a full-range output will be sent to the center speaker output, and with analog and digital surround modes **NO** center channel signal will be sent to the subwoofer output.

When **NONE** is selected, no signal will be sent to the center channel output. The receiver will operate in a "phantom" center channel mode and center channel information will be sent to the left and right front channel outputs. This mode is needed if no Center speaker is used (note that for the use of Logic 7C surround mode a Center speaker is needed, but Logic 7M works well without a Center too).

5. When you have completed your selection for the center channel, press the **▼** button **14** on the remote to change the cursor to **SURROUND**.

6. Press the **◀▶** buttons **15 31** on the remote to select the option that best describes the surround speakers in your system based on the speaker definitions shown on this page.

When **SMALL** is selected, low frequency surround channel sounds will be sent to the Fronts, when Sub is turned off, or to the subwoofer output when Sub is on. With Pro Logic mode, there is no bass in the surround channels.

When **LARGE** is selected, a full-range output will be sent to the surround channel outputs (with all analog and digital surround modes),

and, except with Hall and Theater modes, **NO** surround channel bass will be sent to the subwoofer output.

When **NONE** is selected, surround sound information will be split between the front-left and front-right outputs. Note that for optimal performance when no surround speakers are in use, the Dolby 3 Stereo mode should be used instead of Dolby Pro Logic.

7. When you have completed your selection for the surround channel, press the **▼** button **14** on the remote to move the cursor to **SUBWOOFER**.

8. Press the **◀▶** buttons **15 31** on the remote to select the option that best describes your system.

The choices available for the subwoofer position will depend on the settings for the other speakers, particularly the front left/right positions.

If the front left/right speakers are set to **SMALL**, the subwoofer will automatically be set to **SUB**, which is the "on" position.

If the front left/right speakers are set to **LARGE**, three options are available:

- If no subwoofer is connected to the AVR5000, press the **◀▶** buttons **15 31** on the remote so that **NONE** appears in the on-screen menu. When this option is selected, all bass information will be routed to the front left/right "main" speakers.
- If a subwoofer is connected to the AVR5000, you have the option to have the front left/right "main" speakers reproduce bass frequencies at all times, and have the subwoofer operate only when the AVR5000 is being used with a digital source that contains a dedicated Low Frequency Effects, or LFE soundtrack. This allows you to use both your main and subwoofer speakers to take advantage of the special bass created for certain movies. To select that option press **◀▶** buttons **15 31** on the remote so that **SUB (LFE)** appears in the on-screen menu.

- If a subwoofer is connected and you wish to use it for bass reproduction in conjunction with the main front left/right speakers, regardless of the type of program source or surround mode you are listening to, press the **◀▶** buttons **15 31** on the remote so that **SUB L/R+LFE** appears in the on-screen menu. When this option is selected, a "complete" feed will be sent to the front left/right "main" speakers, and the subwoofer will receive the front left and right bass frequencies under frequency selected in the next option setting on this menu, as described below.

9. When you have completed your selection for the subwoofer, press the **▼** button **14** on the remote to change the cursor to **SUB X-OVER FREQ**.

System Configuration

At this line you will select the frequency at which bass information is directed to the **Subwoofer Output** 12. The choices available will depend on the setting made previously for the front left/right speakers. When making these selections, choose the crossover frequency that is closest to the lower frequency limit of your front left/right speakers or, if using large full range front L/R speakers able to reproduce bass below 40Hz, choose the frequency that is closest to the upper frequency limit of your subwoofer. This figure is normally printed in the Owner's Manual or data sheet for the speakers, or consult the speaker's manufacturer.

- When the front speakers have been set to **L A R G E**, the crossover choices are **4 0 H z** or **6 0 H z** to match the typical crossover points of full range speakers. Choose the option that is closest to your speakers' design.
- When the front speakers have been set to **S M A L L**, the crossover choices are **8 0 H z** or **1 0 0 H z** to match the typical crossover points of the smaller speakers used in satellite speaker systems. Choose the option that is closest to your speakers' design.

10. When all speaker selections have been made, press the **▼** button 14 and then the **Set** button 16 to return to main menu.

11. The Speaker Configuration may also be changed at any time without using the full-OSD on-screen menu system by pressing the **Speaker Select** button on the front panel 27 or remote 32. Once the button is pressed, **F N T S P E A K E R** will appear in both the lower third of the video display and the **Main Information Display** Y.

Within five seconds, either press the front panel **◀▶** Selector buttons 5 or the **▲/▼** buttons 14 on the remote to select a different speaker position, or press the **Set** Button 21 16 to begin the adjustment process for the front left and right speakers

When the **Set** button 21 16 has been pressed and the system is ready for a change to the front speaker setting, the on-screen display and **Main Information Display** Y will read **F N T L A R G E** or **F N T S M A L L** depending on the current setting. Press the front panel **◀▶** Selector Buttons 5 or the **▲/▼** buttons 14 on the remote until the desired setting is shown, using the instructions for "large" or "small" shown earlier, then press the **Set** button 21 16.

If another speaker position needs to be changed, press the front panel **◀▶** Selector buttons 5 or the **▲/▼** buttons 14 on the remote to select a different speaker position, press the **Set** button 21 16 and then press the front panel **◀▶** Selector buttons 5 or the **▲/▼** buttons 14 on the remote until the correct speaker setting is shown and press the **Set** button 21 16 again to confirm the selection.

To assist in making these settings, the icons in the **Speaker/Channel Input Indicators** Q will change as the speaker type is selected at each position. When only the inner icon box is lit, the speaker is set for "small." When the inner box and the two outer boxes with circles inside them are lit, the speaker is set for "large." When no indicator appears at a speaker location, that position is set for "none" or "no" speaker.

Note: These icons are available only when making setup changes in the semi-OSD mode.

As an example, in Figure 6 below, the left front and right front speakers are set for "large," the center, left surround and right surround speakers are set for small, and a subwoofer is set.

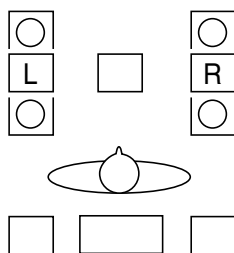

Figure 6

Adjustments for Other Inputs

After one input has been adjusted for surround mode, digital input (if any) and speaker type, return to the **INPUT SETUP** line on the **AUDIO SETUP** menu and enter the settings for each input that you will use. In most cases, only the digital input and surround mode will be different from one input to the next, while the speaker type will usually be the same and may be quickly entered by entering the same data used for the original input.

Making Settings independent of selected Input

After the settings described above have been made for all input sources in your system, the following settings, made with any input, will remain in effect independent of the input selected.

In order to set delay time for Dolby Digital and Dolby Pro Logic surround modes, the OSD menu system must be used.

Delay Settings

Only for the Dolby Digital or Dolby Pro Logic modes, you will need to adjust the delay time setting. Note that the delay time is not adjustable for any other modes.

Important Note: Once the delay time is set with any input it will be effective with all other inputs too. Moreover the surround delay time setting must be made only for either the Dolby Pro Logic or the Dolby Digital mode. The other setting will be set automatically.

Due the different distances between the listening position for the front channel speakers and the surround speakers, the amount of time it takes for sound to reach your ears from the front or surround speakers is different. You may compensate for this difference through the use of the delay settings to adjust the timing for the specific speaker placement and acoustic conditions in your listening room or home theater.

The factory setting is appropriate for most rooms, but some installations create an uncommon distance between the front and surround speakers that may cause the arrival of front channel sounds to become disconnected from surround channel sounds.

To resynchronize the front and surround channels, follow these steps:

1. Measure the distance from the listening/ viewing position to the front speakers in meters.
2. Measure the distance from the listening/ viewing position to the surround speakers.
3. Subtract the distance to the surround speakers from the distance to the front speakers and multiply the result by 3.
 - a. When setting the delay time for the Dolby Digital surround modes, the optimal delay time is the result of that subtraction. For example, if the front speakers are 3 m away and the surround speakers are 1 m away, the optimal delay time is figured as $(3-1) \times 3 = 6$. Thus, in this example, the delay time for Dolby Digital should be set at six milliseconds.
 - b. When setting the delay time for the Pro Logic mode, take the result of the subtraction and add 15 to obtain the optimal delay time. For example, if the front speakers are 3 m away

System Configuration

and the surround speakers are 1 m away, the optimal delay time is figured as $(3-1) \times 3 + 15 = 21$. Thus, in this example, the Pro Logic delay should be set at twenty milliseconds.

NOTE: The DTS, Logic 7, 5CH Stereo, Hall and Theater modes use a fixed, nonadjustable delay time.

The Dolby Digital Mode also includes a separate setting for the center channel delay mode, since the discrete nature of these signals makes the location of the center channel speaker more critical. To calculate the delay for the center channel, measure the distance from the preferred listening position in the center of the room to both the center channel speaker and either the left or right speaker.

If the distances are equal, no further adjustment is required and the center delay should be set to zero. If the distance to the front speakers is greater than the distance to the center speaker, you may wish to reposition the speakers by moving the front left and front right speakers closer to the listening position or the center speaker further away from the listening position.

If repositioning of the speakers is not possible, adjust the center delay time, adding one millisecond of center channel delay for every 30 cm closer to the listening position the center speaker is than the front speakers. For example, if the front left and front right speakers are each 3 m from the listening position and the center channel speaker is 2.4 m away, the delay is figured as $300 \text{ cm} - 240 \text{ cm} = 60 \text{ cm}$, suggesting an optimal center delay of 2 milliseconds.

To set the delay time, continue within the **MASTER MENU** (Figure 1). If the system is not already at that point, press the **OSD** button **22** to bring up the master menu. To make the delay settings for the Dolby Digital mode (this will include the Center delay setting, and the surround delay for the Pro Logic mode will be set automatically), press the **Set** **16** button and select any input now that is associated with a digital input and the Dolby Digital surround mode (the surround mode associated with each input selected will be indicated by the **Surround Mode Indicators** **29** in the front panel), then return to the master menu. Press the **▼** button **14** and then the **Set** button **16** to bring up the surround setup menu, now press the **▼** button **14** once.

As the Dolby Digital mode is selected, the **►** cursor will stop at the **CENTER DELAY** line. Press the **◀▶** buttons **15 31** until the number calculated using the formula shown above appears in the display. When the **CENTER DELAY** is entered, press the **▼** button **14** once to move to the **SURROUND DELAY** line so that the delay for the surround speakers may be set. Press the **◀▶** buttons **15 31** until the desired figure appears in the display, using the number calculated using the formula shown above for the Dolby Digital surround mode (item 3a). When the delay settings are complete, press the **▼** button **14** once to move to the next line.

Note that the delay settings may also be adjusted at any time when the Dolby Digital or Dolby Pro Logic modes are in use by pressing the **Delay** button on the front panel **23** or remote **30**, followed by a press of the **Set** button **16**. Next, press the **▲/▼** buttons **14** on the remote or the **Selector** buttons **5** on the front panel until the desired figure appears in the **Main Information Display** **Y**.

Night Mode Settings

The Night mode is a feature of Dolby Digital that uses special processing to preserve the dynamic range and full intelligibility of a movie sound track while reducing the peak level. This prevents abruptly loud transitions from disturbing others, without reducing the sonic impact of a digital source. Note that the Night mode is only available when Dolby Digital signals are played.

To adjust the Night mode setting from the menu, make certain that the **►** cursor is on the Night line of the **SURROUND SETUP** menu. Next, press **◀▶** buttons **15 31** to choose between the following settings.

OFF: When **OFF** is in the highlighted video, the Night mode will not function.

MID: When **MID** is in the highlighted video, a mild compression will be applied.

MAX: When **MAX** is in the highlighted video, a more severe compression algorithm will be applied.

We recommend that you select the MID setting as a starting point and change to the MAX setting later, if desired.

Note that the Night mode may be adjusted directly any time that a Dolby Digital source is playing by pressing the **Night** button **12**. When the button is pressed, the words **D - RANGE** will appear in the lower third of the video screen and in the **Main Information Display** **Y**. Press the **▲/▼** button **14** within three seconds to select the desired setting, then press **Set** **16** to confirm the setting.

When all settings for the surround setup have been made, press the **▲/▼** buttons **14** so that the **►** cursor is next to **RETURN TO MENU**, and press the **Set** button **16** to return to the master menu.

Output Level Adjustment

Output level adjustment is a key part of the configuration process for any surround sound product. It is particularly important for a Dolby Digital receiver such as the AVR5000, as correct outputs will ensure that you hear sound tracks with the proper directionality and intensity.

NOTE: Listeners are often confused about the operation of the surround channels. While some assume that sound should always be coming from each speaker, most of the time there will be little or no sound in the surround channels. This is because they are only used when a movie director or sound mixer specifically places sound there to create ambiance, a special effect or to continue action from the front of the room to the rear. When the output levels are properly set it is normal for surround speakers to operate only occasionally. Artificially increasing the volume to the rear speakers may destroy the illusion of an enveloping sound field that duplicates the way you hear sound in a movie theater or concert hall.

IMPORTANT NOTE: The output level can be adjusted for each digital and analog surround mode separately. This allows you to compensate for level differences between speakers, that may also vary with the surround mode selected, or to increase or decrease the level of certain speakers intentionally, depending on the surround mode selected.

Before beginning the output level adjustment process, make certain that all speaker connections have been properly made. The system volume should be turned down at first. Finally, make certain that the **Balance Control** **18** is set to the center "12 o'clock" position.

System Configuration

Using EzSet

Harman Kardon's exclusive EzSet remote makes it possible to quickly and accurately set the AVR5000's output levels without the use of a sound pressure meter, although manual adjustment is also available. However, for the easiest set-up, follow these steps while seated in the listening position that will be used most often:

1. Make certain that all speaker positions have been properly configured for their "large" or "small" settings (as outlined above) and turn off the OSD system if it is in use.
2. Adjust the volume so that it is at **-15**, as shown in the on-screen display or **Main Information Display**.
3. Select any input associated with the Dolby Pro Logic surround mode. Remember to make the same adjustment with all other surround modes you've associated with the inputs used.

4. First a non-automatic pre-test should be made: Turn on the internal test tone by pressing the **Test tone** button. You will hear a test noise circulate from speaker to speaker in a clockwise direction around the room.

Listen to make certain that the sound comes from the speaker position shown in the **Main Information Display**. If the sound from a speaker location does NOT match the position indicated, turn the AVR5000 off using the **Main Power Switch** and check the speaker wiring to make certain that each speaker is connected to the correct output terminal.

5. Hold the remote in front of you at arm's length, making sure not to cover the EzSet Sensor Microphone at the top of the remote and aim it at the AVR5000, not vertically (like you'd do with a microphone).

6. Press and hold the **SPL Indicator Select** for three seconds. Release the button when the **Program/SPL Indicator** stops flashing and you hear the test noise from the front left speaker.

7. At this point, the EzSet circuitry will take over, adjusting the output level of each channel so that when the process is complete all levels will be equal and at the set reference point. This process may take a few minutes, depending on the extent of adjustment required.

8. During the adjustment you will see the location of the channel position being adjusted appear in both the on-screen display (if connected) and the **Main Information Display**, alternating with a readout of the output setting, relative to the reference volume level. As the adjustment proceeds, a few things will happen simultaneously:

- The channel position being adjusted will flash in the **Speaker/Channel Position Indicators**. If the test noise is heard from a channel other than the one shown in the Indicator, there is an error in the speaker connections. If this is the case, press the **Test Button** TWICE to stop the adjustment. Then, turn the unit off and verify that all speakers are connected to the proper **Outputs**.

- When the front left channel is being set at the beginning of the process, EzSet will adjust the main volume level, as shown by the indication of the **FRONT LEVEL** alternating in the on-screen display (if connected) and the **Main Information Display** with the volume indication. During the adjustment, the test tone may seem to pulse, or click, as EzSet changes the level. This is a normal aspect of the system's operation.

- As the other channels are set, the channel name and the adjustment offset will appear in the on-screen display (if connected) and the **Main Information Display**. While the level is changing, the **Program/SPL Indicator** will change colors to reflect the output level in relation to the reference. A red indication shows that the level is too high, while an amber indication shows that the level is too low. When the Indicator is green, the level is correct, and the test noise will move to the next channel.

- While adjustments are being made, the red LED under the **AVR Selector** will flash. This is normal, and indicates that EzSet is operating.

9. After the test noise has circulated once through each channel, it will send the tone to the front left channel once again, to finally adjust its output level.

10. Upon completion of the front left channel adjustment, the Program/SPL Indicator will flash green three times and then go out. The tone will stop and the AVR5000 will return to normal operation.

Manual Output Level Adjustment

Output levels may also be adjusted manually, either to set them to a specific level with an SPL meter, or to make fine tuning adjustments to the levels obtained using the EzSet remote.

Manual output level adjustment is most easily done through the **OUTPUT ADJUST** menu (Figure 7). If you are already at the main menu, press the **▼** buttons until the on-screen **▶** cursor is next to the **OUTPUT ADJUST** line. If you are not at the main menu, press the **OSD** button to bring up the **MASTER MENU**, and then press the **▼** buttons three times so that the on-screen **▶** cursor is next to the Output adjust line. Press the **Set** button to bring the **OUTPUT ADJUST** menu (Figure 7) to the screen.

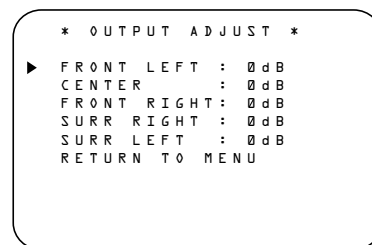

Figure 7

As soon as the new menu appears, you will hear a test noise circulate from speaker to speaker in a clockwise direction around the room. The test noise will play for two seconds in each speaker before circulating, and a blinking on-screen cursor will appear next to the name of each speaker location when the sound is at that speaker. Now turn up the volume until you can hear the noise clearly.

IMPORTANT NOTE: Because this test noise will have a much lower level than normal music, the volume must be lowered after the adjustment for all channels is made, but BEFORE you return to the main menu and the test tone turns off.

After checking for speaker placement, let the test noise circulate again, and listen to see which channels sound louder than the others. Using the front left speaker as a reference, press the **◀▶** buttons on the remote to bring all speakers to the same volume level. Note that when one of the **◀▶** buttons is pushed, the test noise circulation will pause on the channel being adjusted to give you time to make the adjustment. When you release the button, the circulation will resume after five seconds. The on-screen cursor **▶** can also be moved directly to the speaker to be adjusted by pressing the **▲/▼** buttons on the remote.

System Configuration

Continue to adjust the individual speakers until they all have the same volume. Note that adjustments should be made with the ◀▶ buttons **15 31** on the remote only, NOT the main volume controls.

You may also adjust the output levels manually while using the level indication feature of the EzSet remote. To activate the sensor and indicator, simply press and release the **SPL Indicator Select** button **36** on the remote while the test tone is circulating. The **Program/SPL Indicator 3** will change color to indicate the level. Because the remote functions as level sensor, in that case all further adjustments can be made with the front panel buttons only, with help of an assisting person. Adjust the level using the ◀▶ buttons **5** on the front panel until the LED lights green for all channels. When it is red the level is too high; when it is amber the level is too low. Press the **SPL Indicator Select 36** button when you are finished to turn the sensor and Indicator off.

NOTE: The subwoofer output level is not adjustable using the test tone. To change the subwoofer level, follow the steps for Output Level Trim Adjustment on page 32.

When all channels have an equal volume level, the adjustment is complete. Now turn the **Volume 20 34** down to about -40dB, otherwise the listening level may be too high as soon as the source's music starts to play. To exit this menu, press the ▲/▼ buttons **14** until the on-screen ▶ cursor is next to the **RETURN TO MENU** line, and then press the **Set** button **16** to turn the test tone off and return to the **MASTER MENU**.

The output levels may also be adjusted at any time using the discrete buttons and semi-OSD system. To adjust the output levels in this fashion, press the **Test Tone Selector 28 9**. As soon as the button is pressed, the test tone will begin to circulate as indicated earlier. The correct channel from which the test noise should be heard will be shown in the lower third of the video screen and in the **Main Information Display Y**. As an added assist, while the test noise is circulating, the proper channel position will also be indicated in the **Speaker/Channel Indicators Q** by a blinking letter within the correct channel. Turn up the **Volume 20 34** until you can hear the noise clearly.

To adjust the output level, press the **Selector** buttons on the front panel **5** or the ◀▶ buttons **15 31** until the desired level is shown in the display or on screen. Once the buttons are released, the test noise will begin to circulate again in five seconds.

When all channels have the same output level, turn the **Volume 20 34** down to about -40dB, otherwise the listening level may be too high as soon as the source's music starts to play. Afterwards press the **Test Tone Selector 28 9** button again to turn the test tone off and complete the process.

IMPORTANT NOTE: The Output level adjustment made will be effective for all inputs, but only for the actual surround mode selected. To be effective for any other mode select that mode (with any input) and repeat the level adjustment described above. This will also allow you to compensate level differences between speakers, that may be different with each surround mode, or to increase or decrease the level of certain speakers intentionally, depending on the surround mode selected.

Note: Output level adjustment is not available for the VMaX or Surround Off mode, as no surround speakers are used (so level differences between the speakers in the room cannot occur). But to compensate level differences between stereo, VMaX and other surround modes (independently from the input selected) the outputs can be adjusted with the Level Trim Adjustment procedure, see page 32, also for the Surround Off (Stereo) and VMaX modes.

Once the settings outlined on the previous pages have been made, the AVR5000 is ready for operation. While there are some additional settings to be made, these are best done after you have had an opportunity to listen to a variety of sources and different kinds of program material. These advanced settings are described on pages 36-37 of this manual. In addition, any of the settings made in the initial configuration of the unit may be changed at any time. As you add new or different sources or speakers, or if you wish to change a setting to better reflect your listening taste, simply follow the instructions for changing the settings for that parameter as shown above. Note that any settings changed at any time, also when the discrete buttons are used only, will be stored in memory in the AVR5000, also if it's turned off completely, unless it will be reset (see page 56). The settings will either depend on the input (Speaker configuration, analog/digital input selection, surround mode) or on the surround mode selected (speaker output level) or be independent from any input or surround mode (crossover, only depending on the front speaker configuration), as described on previous pages. Having completed the setup and configuration process for your AVR5000, you are about to experience the finest in music and home theater listening. Enjoy!

Operation

Basic Operation

Once you have completed the setup and configuration of the AVR5000, it is simple to operate and enjoy. The following instructions should be followed for you to maximize your enjoyment of your new receiver:

Turning the AVR5000 On or Off

- When using the AVR5000 for the first time, you must press the **Main Power Switch 1** on the front panel to turn the unit on. This places the unit in a Standby mode, as indicated by the amber color of the **Power Indicator 3**. Once the unit is in Standby, you may begin a listening session by pressing the **System Power Control 2** or the **Source button 11** on the front panel or the **AVR Selector 6 B**. Note that the **Power Indicator 3** will turn green. This will turn the unit on and return it to the input source that was last used. The unit may also be turned on from Standby by pressing any of the **Source Selector buttons** on the remote **5 37 7 B C D**.

NOTE: After pressing one of the **Input Selector buttons 5 D** (except VID4) to turn the unit on, press the **AVR Selector 6 B** to have the remote control the AVR functions.

To turn the unit off at the end of a listening session, simply press the **System Power Control 2** on the front panel or the **Power Off Button 4 A** on the remote. Power will be shut off to any equipment plugged into the rear panel **Switched AC Outlets 16** and the **Power Indicator 3** will turn amber.

When the remote is used to turn the unit "off" it is actually placing the system in a Standby mode, as indicated by the amber color of the **Power Indicator 3**.

When you will be away from home for an extended period of time it is always a good idea to completely turn the unit off with the front panel **Main Power Switch 1**.

NOTE: All preset memories may be lost if the unit is left turned off with the **Main Power Switch 1** for more than two weeks.

Using the Sleep Timer

- To program the AVR5000 for automatic turn-off, press the **Sleep Button 10** on the remote. Each press of the button will increase the time before shut down in the following sequence:

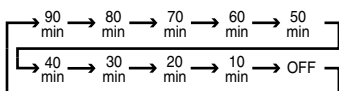

The sleep time will be displayed in the **Preset Number/Sleep Timer Indicator R** and it will count down until the time has elapsed.

When the programmed sleep time has elapsed, the unit will automatically turn off (to Standby mode). Note that the front panel display will dim to one half brightness when the Sleep function is programmed. To cancel the Sleep function, press and hold the **Sleep Button 10** until the information display returns to normal brightness and the Sleep indicator numbers disappear and the words **S L E E P O F F** appear in the **Main Information Display Y**.

Source Selection

- To select a source, press any of the **Source Selector buttons** on the remote **5 7 C D**.

NOTE: After pressing one of the **Input Selector buttons 5 D** (except VID4) to turn the unit on, press the **AVR Selector 6 B** to have the remote control the AVR functions.

- The input source may also be changed by pressing the front-panel **Input Source Selector button 11**. Each press of the button will move the input selection through the list of available inputs.

- As the input is changed, the AVR5000 will automatically switch to the digital input (if selected), surround mode and speaker configuration that were entered during the configuration process for that source.

- The front-panel **Video 4 Inputs 16** may be used to connect a device such as a video game or camcorder to your home entertainment system on a temporary basis.

- As the input source is changed, the new input name will appear momentarily as an on-screen display in the lower third of the video display. The input name will also appear in the **Main Information Display Y** and a green LED will light next to the selected input's name in the front-panel **Input Indicators 22**.

- When a pure audio source (Tuner, CD, Tape, 6 Channel direct inputs) is selected, the last video input used remains routed to the **Video 1 and Video 2 Outputs 23 26** (except from its own Video 1/ source) and **Video Monitor Output 13**. This permits simultaneous viewing and listening to different sources.

- When a Video source is selected, its audio signal will be fed to the speakers and the video signal for that input will be routed to the appropriate **Monitor Output jack 13** and will be viewable on a TV monitor connected to the AVR5000. If a component video input is connected to the **DVD 36** or **Video 2 35** component inputs, it will be routed to the **Component Video Outputs 34**. Make certain that your TV is set to the proper input to view the appropriate video signal (composite, S-Video or component video, see Notes for S-Video on page 16).

Controls and Use of Headphones

- Adjust the volume to a comfortable level using the front panel **Volume Control 20** or remote **Volume Up/Down 34 1** buttons.

- The **Balance Control 18** may be used to adjust the relative sound output between the left front and right front speakers.

- To temporarily silence all speaker outputs press the **Mute button 38**. This will interrupt the output to all speakers and the headphone jack, but it will not affect any recording or dubbing that may be in progress. When the system is muted, the **MUTE indicator Z** will light in the **Main Information Display 25**. Press the **Mute button 38** again to return to normal operation.

- During a listening session you may wish to adjust the **Bass Control 17** and **Treble Control 19** to suit your listening tastes or room acoustics. Note that these controls are not effective with the 6-Channel Direct Input.

- To set the output of the AVR5000 so that the output is "flat," with the Tone controls and the Balance control de-activated, press the **Tone Mode button 6** button once or twice so that the words **Tone Out** appear momentarily in the **Main Information Display Y**. To return the tone controls to an active condition, press the **Tone Mode 6** button once or twice so that the words **Tone In** momentarily appear in the **Main Information Display Y**.

- For private listening, plug the 6.3 mm stereo phone plug from a pair of stereo headphones into the front panel **Headphone Jack 4**. Note that when the headphone's plug is connected, the word **HEADPHONE** will scroll once across the **Main Information Display Y** and all speakers will be silenced. When the headphone plug is removed, the audio feed to the speakers will be restored.

Operation

Surround Mode Chart

MODE	FEATURES	DELAY TIME RANGE
DOLBY DIGITAL	Available only with digital input sources encoded with Dolby Digital data. It provides up to five separate main audio channels and a special dedicated Low Frequency Effects channel.	Center: 0 ms – 5 ms Initial Setting – 0 ms Surround: 0 ms – 15 ms Initial Setting – 0 ms
DTS	Available only with digital input sources encoded with DTS data. Available on special DVD, LD and audio-only discs, DTS provides up to five separate main audio channels and a special dedicated low frequency channel.	Delay time not adjustable
DOLBY PRO LOGIC	The standard mode for analog surround sound decoding. It uses information encoded in a two channel stereo recording to produce four distinct outputs: Left, Center, Right and a Mono Surround channel. Use this mode for accurate reproduction of programs bearing the Dolby Surround, DTS Stereo, UltraStereo or other "Surround" logos. Surround-encoded programs include videocassette, DVD and LD movies, TV and cable programs, radio programs and audio CDs. Dolby Pro Logic processing may also be used to provide a pleasing surround effect with some stereophonic source material that does not carry surround encoding.	15 ms – 30 ms Initial Setting = 15 ms
LOGIC 7 C LOGIC 7 M	An advanced mode that extracts the maximum surround information from either conventional stereo material or surround-encoded programs. When used with encoded material, decoding is more accurate in terms of the placement of sounds, and fades and pans are much smoother and more realistic than with other decoding techniques. Logic 7 also delivers increased spaciousness and a wider sound stage when it is used with conventional natural stereo recordings and music programs through the use of the natural surround information present also in those stereo recordings. The Logic 7C or Cinema mode is tailored to provide an optimal sound field for movie soundtracks. The Logic 7M or Music mode uses a decoding formula that is best suited to music.	Delay time not adjustable
DOLBY 3 STEREO	Uses the information contained in a surround encoded or two channel stereo program to create center channel information. In addition, the information that is normally sent to the rear channel surround speakers is carefully mixed in with the front left and front right channels for increased realism. Use this mode when you have a center channel speaker but no surround speakers.	No surround channels
THEATER	This surround processing uses matrix surround decoding to simulate a standard movie or stage theater with stereo and even pure mono sources.	Delay time not adjustable
HALL 1 and HALL 2	The two Hall modes offer matrix surround decoding choices that simulate a medium-sized chamber hall or opera house with stereo and even pure mono sources.	Delay time not adjustable
VMAx Near VMAx Far	When only the two front channel loudspeakers are used, Harman's patented VMAx mode delivers a three-dimensional sound space with the illusion of "phantom speakers" at the center and surround positions. The VMAx N, or "Near Field" mode should be selected when your listening position is less than 1,5m from the speakers. The VMAx F, or "Far Field" mode should be selected when your listening position is greater than 1,5m from the speakers.	No surround channels
5-Channel Stereo	This mode takes advantage of multiple speakers to place a stereo signal at both the front and back of a room. Ideal for playing music in situations such as a party, it places the same signal at the front-left and surround-left, and at the front-right and surround-right speakers. The center channel is fed a summed mono mix of the in-phase material of the left and right channels.	No delay is available for this mode
SURROUND OFF (STEREO)	This mode turns off all surround processing and presents the pure left and right channel presentation of two channel stereo programs.	No surround channels

Operation

Surround Mode Selection

One of the most important features of the AVR5000 is its ability to reproduce a full multi-channel surround sound field from digital sources, analog matrix surround encoded programs and standard stereo or even mono programs. In all, a total of thirteen listening modes are available on the AVR5000.

Selection of a surround mode is based on personal taste, as well as the type of program source material being used. For example, motion pictures or TV programs bearing the logo of one of the major surround encoding processes, such as Dolby Surround, DTS Stereo or UltraStereo⁺⁺ should be played in either the Dolby 3 Stereo or Dolby Pro Logic surround modes depending on the source material and speakers in use.

However to create wider, enveloping sound field environments and more defined pans and flyovers with all analog stereo and surround recordings select Harman Kardon's exclusive Logic 7 mode, that creates a stereophonic left and right rear signal, just as recorded in real life (e.g. sound being recorded from left rear side will be heard from that side only) for a dramatic improvement in comparison to Dolby Pro Logic.

NOTE: Once a program has been encoded with matrix surround information, it retains the surround information as long as the program is broadcast in stereo. Thus, movies with surround sound may be decoded via any of the analog surround modes such as Pro Logic or Logic 7, when they are broadcast via conventional TV stations, cable, pay TV and satellite transmission. In addition, a growing number of made-for-television programs, sports broadcasts, radio dramas and music CDs are also recorded in surround sound. You may view a list of these programs at the Dolby Laboratories Web site at www.dolby.com.

Even when a program is not listed as carrying intentional surround information, you may find that the Pro Logic, Dolby 3 Stereo or Logic 7 modes often deliver enveloping surround presentations through the use of the natural surround information present in all stereo recordings. However, for stereo programs without any surround information the Theater, Hall and 5CH Stereo modes should be tried (5CH Stereo is effective particularly with old "extreme" stereo recordings) and for mono programs, we suggest that you try the Theater or Hall modes. And when you use only two front channel speakers you should select Harman's patented VMaX mode, delivering a virtually three dimensional sound space with two speakers only.

Surround modes are selected using either the front panel controls or the remote. To select a surround mode from the front panel, press the **Surround Mode Selector** **7** to scroll through the list of available modes. To select a surround

mode using the remote, press the **Surround Mode Selector** **11**, and then press the **▲/▼** buttons **14** to change the mode. As you press the buttons, the Surround mode name will appear in the **Main Information Display** **Y**, and an individual mode indicator will also light up **C D F H I J K L N**. As the surround modes change, a green LED will light next to the current mode in the **Surround Mode Indicators** list **29** on the front panel.

Note that the Dolby Digital or DTS modes may only be selected when a digital input is in use. In addition, when a digital source is present, the AVR5000 will automatically select and switch to the correct mode (Dolby Digital or DTS), regardless of the mode that has been previously selected. For more information on selecting digital sources, see the following section of this manual.

To listen to a program in traditional two channel stereo, using the front left and front right speakers only (plus the subwoofer if installed and configured), follow the instructions shown above for using the remote until **SURR OFF** appears in the **Main Information Display** **Y**.

Digital Audio Playback

Digital audio is a major advancement over past systems such as Dolby Pro Logic. It delivers five discrete channels: left front, center, right front, left surround and right surround. Each channel reproduces full frequency range (20Hz to 20kHz) and offers dramatically improved dynamic range and significant improvements to signal-to-noise ratios. In addition, digital systems have the capability to deliver an additional channel that is specifically devoted to low frequency information. This is the ".1" channel referred to when you see these systems described as "5.1". The bass channel is separate from the other channels, but since it is intentionally bandwidth limited, sound designers have given it that unique designation.

Dolby Digital

Dolby Digital (originally known as AC-3[®]) is a standard part of DVD, and is available on specially encoded LD discs and satellite broadcasts and it is a part of the new high-definition television (HDTV) system.

Note that an optional, external RF demodulator is required to use the AVR5000 to listen to the Dolby Digital sound tracks available on laser discs. Connect the RF output of the LD player to the demodulator and then connect the digital output of the demodulator to the **Optical** or **Coaxial** inputs **28 29 13 15** of the AVR5000. No demodulator is required for use with DVD players or DTS-encoded laser discs.

DTS

DTS is another digital audio system that is capable of delivering 5.1 audio. Although both DTS and Dolby Digital are digital, they use different methods of encoding the signals, and thus they require different decoding circuits to convert the digital signals back to analog.

DTS-encoded sound tracks are available on select DVD and LD discs, as well as on special audio-only DTS CDs. You may use any LD, DVD or CD player equipped with a digital output to play DTS-encoded special audio-only CDs with the AVR5000, but DTS-LDs can be played on LD players and DTS-DVDs on DVD players only. All that is required is to connect the player's output to either the **Optical** or **Coaxial** input on the rear panel **28 29** or front panel **13 15**.

In order to listen to DVDs encoded with DTS sound tracks, the DVD player must be compatible with the DTS signal as indicated by a DTS logo on the player's front panel. Note that early DVD players may not be able to play DTS-encoded DVDs. This does not indicate a problem with the AVR5000, as some players cannot pass the DTS signal through to the digital outputs. If you are in doubt as to the capability of your DVD player to handle DTS DVDs, consult the player's owner's manual.

PCM Audio Playback

PCM (Pulse Code Modulation) is the non-compressed digital audio system used for compact discs, Non-Dolby Digital/DTS Laserdiscs and some special PCM encoded DVDs. The digital circuits in the AVR5000 are capable of high quality digital-to-analog decoding, and they may be connected directly to the digital audio output of your CD/DVD or LD player (LD only for PCM or DTS programs, for Dolby Digital laser discs an RF adapter is needed, see "Dolby Digital" above).

Connections may be made to either the **Optical** or **Coaxial** inputs **28 29** on the rear panel or the front panel **Digital Inputs** **13 15**.

To listen to a PCM digital source, first select the input for the desired source (e.g., CD) to feed its video signal (if any) to the TV monitor and to provide its analog audio signal for recording. Next press the **Digital Select** button **24 17** and then use the **▲/▼** buttons **14** on the remote, or the **Selector** buttons **5** on the front panel, until the desired choice appears in the **Main Information Display** **Y**, then press the **Set** button **21 16** to confirm the choice.

When a PCM source is playing, the **PCM** indicator **A** will light. During PCM playback you may select any surround mode except Dolby Digital or DTS. When an HDCD encoded disc is being played (see below) and the CD player is connected to the AVR 5000 via a digital connection, select Surround Off as the Surround mode to enjoy the benefits of the HDCD process.

Operation

Playback from PCM sources may also benefit from the Logic 7. When playing a stereo or surround-encoded PCM source, such as an LD or CD or a PCM audio track from DVD, use the Logic 7 C or Cinema mode. For stereo or surround encoded pure music recordings use the Logic 7 M or Music mode for a wider front sound stage (see Surround Mode Chart page 28).

HDCD

HDCD, which stands for High Definition Compatible Digital®, is a sophisticated process that enables the AVR 5000 to deliver outstanding digital-to-analog decoding of PCM signals from any DVD or CD player, connected to a digital input on the AVR 5000, no matter what type of CD or DVD is played and even when normal, Non-HDCD-compatible players are used (only a digital output is needed).

When a CD with the HDCD logo is played, the AVR 5000 is able to take advantage of the special recording process that is used in the creation of HDCD disc. The special circuitry enables audio with extraordinary fidelity, stunning resolution and the highest possible overall quality.

The AVR 5000 will automatically sense that it is an HDCD recording and the **HDCD indicator A** will illuminate on the front panel to remind you that an HDCD disc is playing.

It is important to note that the HDCD process is completely compatible with standard recordings. Indeed, the high-quality digital-to-analog circuitry that is part of HDCD and the HDCD decoder chip, replacing the monolithic digital filters used in conventional DACs, will enable enhanced performance also with normal, non-HDCD encoded program material.

MP3 Audio Playback

The AVR5000 is one of the first A/V receivers to provide on-board decoding for the MP3 audio format used on specific computer audio files and by portable MP3 players/recorders. In addition, some new CD and DVD players are capable of playing back optical discs that are recorded with MP3, rather than standard CD audio information. By offering MP3 decoding, the AVR5000 is able to deliver more precise conversion of the digital signals to an analog output, along with the benefits of listening to MP3 audio through the AVR5000's high current amplifier and the speakers from your surround system, rather than the smaller speakers and low powered amplifiers typically used with computers.

To take advantage of the AVR5000's MP3 capabilities, simply connect the PCM output of a computer sound card able to feed the MP3 format to its digital output, or the PCM output of MP3 compatible CD or DVD players or of a portable MP3 player with a digital output, to either the rear panel **Digital Inputs 13 15** or the front

panel **Digital Inputs 13 15**. When the digital MP3 signal is selected, the **MP3 Bitstream Indicator A** will light, and the audio will begin playing.

NOTES:

- The AVR5000 is only capable of playing signals in the MP3 (MPEG 1/Layer 3) format. It is not compatible with other computer audio codecs.

- The MP 3 DSP mode found in the new AVR5000 requires an MP3 SPDIF stream. Presently, only a few units provide this but in the coming generations of motherboards and operating system updates this will follow, since SPDIF is the standard for audio & video hardware.

- The digital audio input signal may be either optical or coaxial, but the signal must be in the PCM format. Direct connection of USB or serial data outputs is not possible, even though the signals are in the MP3 format. If you have any questions about the data output format from your computer or a sound card, check with the device's Owner's Manual or contact the manufacturer's technical support area.

Selecting a Digital Source

To utilize either digital mode you must have properly connected a digital source to the AVR5000. Connect the digital outputs from DVD players, HDTV receivers, satellite systems or CD players to the **Optical** or **Coaxial** inputs on the rear or front panel **28 29 13 15**. In order to provide a backup signal and a source for analog stereo recording, the analog outputs provided on digital source equipment should also be connected to their appropriate inputs on the AVR5000 rear panel (e.g., connect the analog stereo audio output from a DVD to the **DVD inputs 6** on the rear panel when you connect the source's digital outputs).

When playing a digital source such as DVD, first select its input using the remote or front panel controls as outlined in this manual in order to feed its video signal (if any) to the TV monitor and to provide its analog audio signal for recording. When the digital input appropriate with the DVD player is not selected automatically (due to the input settings made earlier during the system configuration, see page 21), select the digital source by pressing the **Digital Input Selector** button **17 24** and then using the **▲/▼** buttons **14** on the remote or the **Selector** buttons **5** on the front panel to choose any of the **OPTICAL** or **COAXIAL** inputs, as they appear in the **Main Information Display Y**, **Display Indicator BE** or on-screen display. When the digital source is playing, the AVR5000 will automatically detect whether it is a multi-channel Dolby Digital or DTS source or a HDCD, MP3 or conventional PCM signal, which is the standard output from CD players. A **Bitstream Indicator A** will light in the **Main**

Information Display 25 to confirm that the digital signal is Dolby Digital, DTS, MP3, PCM or HDCD.

Note that a digital input (e.g. coaxial) remains associated with any analog input (e.g. DVD) as soon as it is selected, thus the digital input need not be re-selected each time the appropriate input choice (e.g. DVD) is made.

Digital Status Indicators

When a digital source is playing, the AVR5000 senses the type of bitstream data that is present. Using this information, the correct surround mode will automatically be selected. For example, DTS bitstreams will cause the unit to switch to DTS decoding, and Dolby Digital bitstreams will enable Dolby Digital decoding. When the unit senses PCM data, from CDs and LDs and some music DVDs or certain tracks on normal DVDs, it will allow the appropriate surround mode to be selected manually. Since the range of available surround modes depends on the type of digital data that is present, the AVR5000 uses a variety of indicators to let you know what type of signal is present. This will help you to understand the choice of modes and the input channels recorded on the disc.

When a digital source is playing, a **Bitstream Indicator A** will light to show which type of signal is playing:

DOLBY D: When the DOLBY D indicator lights, a Dolby Digital bitstream is being received. Depending on the audio track selected on the source player and number of channels on the disc, different surround modes are possible. Note that only one channel without subwoofer, called "1.0" audio, or all five channels with subwoofer ("5.1" audio) or all steps between can be recorded on digitally surround encoded audio tracks (see NOTE below). With all those tracks, except "2.0" audio, only the Dolby Digital and VMAx modes are available. When the Dolby Digital signal is only two channel ("2.0") these two channels (l and r) often contain Pro Logic surround informations. With those tracks the AVR5000 automatically switches to the Pro Logic mode, but you may also select the Vmax mode.

DTS: When the DTS indicator lights, a DTS bitstream is being received. When the unit senses this type of data, only the DTS mode may be used.

PCM: When the PCM indicator lights, a standard Pulse Code Modulation, or PCM, signal is being received. This is the type of digital audio used by conventional compact disc and laser disc recordings. When a PCM bitstream is present, all modes except Dolby Digital and DTS are available. Note that the PCM signal format can be selected on the DVD player with any audio track, even with Dolby Digital tracks (but not with Dolby Digital decoding). So, if selected, even "2.0" D.D. audio tracks

Operation

can be played with all surround modes, also with the most effective Logic 7.

HDCD[®]: When this indicator lights in conjunction with the PCM indicator, the CD that is playing is encoded using the special High Definition Compatible Digital[®] process. HDCD[®] discs use 20-bit encoding and other proprietary processing to provide the ultimate in CD listening. Note that HDCD processing is only available in the Stereo or Surround Off mode.

MP3: When the MP3 indicator lights, a compatible MPEG 1/Layer 3 digital signal is being received. This is the popular audio format used by many computer programs for recording compressed audio files. When an MP3 bitstream is present, the sound will automatically be played in the stereo (surround off) mode. The surround modes are not available during MP3 playback.

In addition to the **Bitstream Indicators**, the AVR5000 features a set of unique channel input indicators that tell you how many channels of digital information are being received and if the digital signal is interrupted.

These indicators are the L/C/R/LS/RS/LFE letters that are inside the center boxes of the **Speaker/Channel Input Indicators** **Q** in the front panel **Main Information Display** **25**. When a standard analog stereo or matrix surround signal is in use, only the "L" and "R" indicators will light, as analog signals have only left and right channels, respectively, even surround recordings, carry surround information on the left and right channels only.

Digital signals, however, may have one to six separate channels, depending on the program material, the method of transmission and the way in which it was encoded. When a digital signal is playing, the letters in these indicators will light in response to the specific signal being received. It is important to note that although Dolby Digital, for example, is referred to as a "5.1" system, not all Dolby Digital DVD or audio tracks selected on DVD or other Dolby Digital programs are encoded for 5.1. Thus, it is sometimes normal for a DVD with a Dolby Digital soundtrack to trigger e.g. only the "L" and "R" indicators.

NOTE: Many DVD discs are recorded with both "5.1" and "2.0" versions of the same soundtrack, the "2.0" version often is used with other languages. When playing a DVD, always be certain to check the type of material on the disc. Most discs show this information in the form of a listing or icon on the back of the disc jacket. When a disc does offer multiple soundtrack choices you may have to make some adjustments to your DVD player (usually with the "Audio

Select" button or in a menu screen on the disc) to send a full 5.1 feed to the AVR5000 or to select the appropriate audio track and thus language ("2.0" audio tracks can be played with all surround modes, even with Logic 7, see indicator "PCM" on page 30). It is also possible for the type of signal feed to change during the course of a DVD playback. In some cases the previews of special material will only be recorded in 2.0 audio, while the main feature is available in 5.1 audio. As long as your DVD player is set for 6-channel output, the AVR5000 will automatically sense changes to the bitstream and channel count and reflect them in these indicators.

The letters used by the **Speaker/Channel Input Indicators** **Q** also flash to indicate when a bitstream has been interrupted. This will happen when a digital input source is selected before the playback starts, or when a digital source such as a DVD is put into a Pause mode. The flashing indicators remind you that the playback has stopped due to the absence of a digital signal and not through any fault of the AVR. This is normal, and the digital playback will resume once the playback is started again.

Night Mode

A special feature of Dolby Digital is the Night mode, which enables Dolby Digital input sources to be played back with full digital intelligibility while reducing the maximum peak level and lifting the low levels by 1/4 to 1/3. This prevents abruptly loud transitions from disturbing others without reducing the impact of the digital source. The Night mode is available only when Dolby Digital mode is selected.

The Night mode may be engaged when a Dolby Digital DVD is playing by pressing the **Night Button** **12** on the remote. Next, press the **▲/▼** buttons **14** to select either the middle range or full compression versions of the Night mode. To turn the Night mode off, press the **▲/▼** buttons **14** until the message in the lower third of the video display and the **Main Information Display** **Y** reads **D - RANGE OFF**. When the Night mode is active, the **Night Mode Indicator** **Q** will also illuminate.

The Night mode may also be selected to always be on at either level of compression using the options in the Surround Setup Menu. See page 24 for information on using the menus to set this option.

IMPORTANT NOTES ON DIGITAL PLAYBACK:

1. When the digital playback source is stopped, or in a pause, fast forward or chapter search mode, the digital audio data will momentarily stop, and the channel position letters inside the **Speaker/Channel Indicators** **Q** will flash. This is normal and does not indicate a problem

with either the AVR5000 or the source machine. The AVR5000 will return to digital playback as soon as the data is available and when the machine is in a standard play mode.

2. Although the AVR5000 will decode virtually all DVD movies, CDs and HDTV sources, it is possible that some future digital sources may not be compatible with the AVR5000.

3. Note that not all digitally encoded programs and not all audio tracks on a DVD contain full 5.1-channel audio. Consult the program guide that accompanies the DVD or laser disc to determine which type of audio has been recorded on the disc. The AVR5000 will automatically sense the type of digital surround encoding used, indicate it in the **Bitstream Indicators** **A** and **Channel Input Indicators** **Q** and adjust to accommodate it.

4. When a Dolby Digital or DTS source is playing, you normally may not be able to select some of the analog surround modes such as Dolby Pro Logic, Dolby 3, Stereo, Hall, Theater, 5CH Stereo or Logic 7, except with special audio tracks (see indication "Dolby Digital" on previous page) or data format selected (see "PCM" on previous page).

5. When a Dolby Digital or DTS source is playing, it is not possible to make an analog recording using the **Tape** **2** or **Video 1** or **Video 2** or **5** **33** record outputs, if the source is connected to any digital input of the AVR5000 only. But the analog two channel signal of that source, the "Downmix" to Stereo or Dolby Surround, can be recorded by connecting its analog audio outputs to the appropriate analog inputs (e.g. DVD) of the AVR5000, even if the digital input of the AVR5000 remains selected. Additionally, the digital signals will be passed through to the **Digital Audio Outputs** **30**.

Tape Recording

In normal operation, the audio or video source selected for listening through the AVR5000 is sent to the record outputs. This means that any program you are watching or listening to may be recorded simply by placing machines connected to the outputs for **Tape Outputs** **2** or **Video 1** or **2 Outputs** **5** **23** **25** in the record mode.

When a digital audio recorder is connected to any of the **Digital Audio Outputs** **30**, you are able to record the digital signal using a CD-R, MiniDisc or other digital recording system. Note that all digital signals will be passed through to both, coaxial and optical, digital outputs simultaneously, no matter which kind of digital input was selected.

HDCD, HDCD[®], High Definition Compatible Digital[®] and Pacific Microsonics[™] are either registered trademarks or trademarks of Pacific Microsonics, Inc., in the United States and/or other countries. HDCD System manufactured under license from Pacific Microsonics, Inc.

Operation

In addition to the rear panel digital outputs, the AVR 5000 offers Harman Kardon's exclusive configurable front panel output jack feature. For easy connection of portable devices, you may switch the front panel **Digital Coax** jack **15** or the **Video 4** jack **16** from an input to an output by following these steps:

1. Press the **OSD** button **22** to view the **MASTER MENU** (Figure 1).
2. Press the **Set** button **16** to enter the **IN/OUT SETUP** menu (Figure 2).
3. Press the **▼** button **14** so that the on-screen **▶** cursor is next to **VIDEO 4** or **COAXIAL 3** depending on which input you wish to change to an output. Either input, or both may be changed at any time.
4. Press either of the **◀▶** buttons **15/31** so that the word **OUT** is highlighted.
5. Press the **OSD** button **22** to exit the menus and return to normal operation.

Note that once the setting is made, the appropriate **Input/Output Status Indicator 14** will turn red, indicating that the selected analog or digital jacks are now an output, instead of in the default setting as an input. Once changed to an output, the setting will remain as long as the AVR 5000 is turned on, unless the setting is changed in the OSD menu system, as described above. Note, however, that once the AVR 5000 is turned off, the setting is cancelled. When the unit is turned on again, the front panel jacks will return to their normal default setting as an input. If you wish to use their jacks as an output at a future time, the setting must be changed again using the OSD menu system, as described above.

NOTES:

- The digital outputs are active only when a digital signal is present, and they do not convert an analog input to a digital signal, or change the format of the digital signal (e.g. Dolby Digital to PCM or vice versa, but coaxial digital signals are converted to optical signals and vice versa). In addition, the digital recorder must be compatible with the output signal. For example, the PCM digital input from a CD player may be recorded on a CD-R or MiniDisc, but Dolby Digital or DTS signals may not.
- To make an analog recording of a Dolby Digital or DTS source is not possible, if the source is connected to a digital input of the AVR5000 only. But the analog two channel signal of that source can be recorded (see item 5, "Important Notes on Digital Playback" above).

Output Level Trim Adjustment

Normal output level adjustment for the AVR5000 is established using the test tone, as outlined on pages 24 and 25. In some cases, however, it may be desirable to adjust the output levels using program material such as a test disc, or a selection you are familiar with. Additionally, the output level for the subwoofer and those for the Stereo and VMax modes can only be adjusted using this procedure.

To adjust the output levels using program material, first select the surround mode for which you want to trim the speakers (see NOTE below), start your program material source and set the reference volume for the front left and front right channels using the **Volume Control 20/34 1**.

Once the reference level has been set, press the **Channel Select** button **13/26** and note that **FRONT LEFT LEV** will appear in the **Main Information Display Y**. To change the level, first press the **Set** button **16/21**, and then use the **Selector** buttons **5** or the **▲/▼** buttons **14** to raise or lower the level. DO NOT use the volume control, as this will alter the reference setting.

Once the change has been made, press the **Set** button **16/21** and then press the **Selector** buttons **5** or the **▲/▼** buttons **14** to select the next output channel location that you wish to adjust. To adjust the subwoofer level, press the **Selector** buttons **5** or the **▲/▼** buttons **14** until **SUBWOOFER LEV** appears in the **Main Information Display Y** or on-screen display. (only available if the subwoofer is turned on).

Press the **Set** button **16/21** when the name of the desired channel appears in the **Main Information Display Y** and on-screen display, and follow the instructions shown above to adjust the level.

Repeat the procedure as needed until all channels requiring adjustment have been set. When all adjustments have been made press the **Set** button **16/21** twice, the AVR5000 will return to normal operation.

If you are using a disc with noise test signals or an external signal generator as the source from which to trim the output levels, you may use the EzSet feature of the remote to guide you to the correct SPL level. To use the remote for this purpose, start the test tone from the source and press **and quickly release** the **SPL Indicator Select 36** to activate the sensor. When the test tone from the source is fed to the speaker you want to trim, the **Program Indicator 3** will change color to indicate the level. Adjust the level for the appropriate channel until the LED lights green for all channels. When it is red the

level is too high; when it is amber the level is too low. As the remote is used as sound pressure level (SPL) sensor, in this case the channels can be selected and their levels be adjusted, as described above, with the **Channel Select** button **26** and the **Selector 5** and **Set** buttons **21** on the AVR's front panel only (with help of an assisting person). After the output levels of all channels are aligned, press the **SPL Indicator Select 36** to turn the sensor and indicator off.

The channel output may also be adjusted using the full-OSD on-screen menu system. First, set the volume to a comfortable listening level using the **Volume Control 20/34 1**. Then, press the **OSD** button **22** to bring up the **MASTER MENU** (Figure 1). Press the **▼** Button **14** until the on-screen **▶** cursor is next to the **CHANNEL ADJUST** line. Press the **Set** Button **16** to activate the **CHANNEL ADJUST** menu (Figure 8).

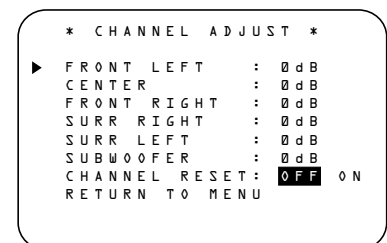

Figure 8

Once the menu appears on your video screen, use the **▲/▼** buttons **14** to move the on-screen **▶** cursor so that it is next to the channel that you wish to adjust. Then, use the **◀▶** buttons **15/31** to raise or lower the output level.

When all adjustments are done, press the **▲/▼** buttons **14** to move the on-screen **▶** cursor so that it is next to **RETURN TO MENU** and then press the **Set** Button **16** if you wish to go back to the main menu to make other adjustments. If you have no other adjustments to make, press the **OSD** button **22** to exit the menu system.

NOTE: The output levels may be separately trimmed for each digital and analog surround mode. If you wish to have different trim levels for a specific mode, select that mode and then follow the instructions in the steps shown above.

Changing the levels by the trim adjustment as described above will automatically change the level settings in the Output Adjust Menu (Fig. 7, page 25) correspondingly (and vice versa). With Stereo and Vmax modes the adjustment procedure described above is the only way to trim the output level (e.g. to match the Vmax level with other modes).

Operation

6-Channel Direct Input

The AVR5000 is equipped for future expansion through the use of optional, external adapters for formats that the AVR5000 may not be capable of processing. When an adapter is connected to the **6-Channel Direct Input** 9, you may select it by pressing the **6-Ch Direct Input Selector** 37. The 6-Channel Direct Input may also be selected by pressing the **Input Source Selector** button 11 on the front panel until the words **6 CH DIRECT** appear in the **Main Information Display** 17, and a green LED lights next to **6 CH** in the **Input Indicators** 22.

Note that when the 6-Channel Direct Input is in use, you may not select a surround mode, as the external decoder determines processing. In addition, there is no signal at the record outputs when the 6-Channel Direct Input is in use, and the **Tone** 17 19 and **Balance** 18 controls will not be effective.

Memory Backup

This product is equipped with a memory backup system that preserves tuner presets and system configuration information if the unit is turned off completely, accidentally unplugged or subjected to a power outage. This memory will last for approximately two weeks, after which time all information must be reentered.

Tuner Operation

The AVR5000's tuner is capable of tuning AM, FM and FM Stereo broadcast stations and receiving RDS data. Stations may be tuned manually, or they may be stored as favorite station presets and recalled from a 30 position memory.

Station Selection

1. Press the **AM/FM Tuner Select** button 7 on the remote to select the tuner as an input. The tuner may be selected from the front panel by either pressing the **Input Source Selector** 11 until the tuner is active or by pressing the **Tuner Band Selector** 9 at any time.
2. Press the **AM/FM Tuner Select** button 7 or **Tuner Band Selector** 9 again to switch between AM and FM so that the desired frequency band is selected.
3. Press the **Tuner Mode** button 19 on the remote or hold the **Band Selector** 9 on the front panel pressed for 3 seconds to select manual or automatic tuning.

When the **AUTO** indicator X is illuminated in the Main Information Display the tuner will only stop at those stations that have a strong enough signal to be received with acceptable quality.

When the **AUTO** indicator X is not illuminated, the tuner is in a manual mode and will stop at each frequency increment in the selected band.

4. To select stations press any **Tuning** button 8 21. When the **AUTO** indicator X is illuminated, press the button to cause the tuner to search for the next highest or lowest frequency station that has an acceptable signal or hold the button pressed to tune more quickly and release it to start the auto search. In the Auto mode the tuner will play each station in stereo or mono mode, just as the program is transmitted. If the **AUTO** indicator X is not illuminated, tap the **Tuning** button 8 21 to advance one frequency increment at a time, or press and hold it to locate a specific station. When the **TUNED** indicator W illuminates, the station is properly tuned and should be heard with clarity.

5. Stations may also be tuned directly by pressing the **Direct** button 20, and then pressing the **Numeric Keys** 18 that correspond to the station's frequency. The desired station will automatically be tuned after the latest number is entered. If you press an incorrect button while entering a direct frequency, press the **Clear** button 23 to start over.

NOTE: When the FM reception of a stereo station is weak, audio quality will be increased by switching to Mono mode by pressing the **Tuner Mode** button 19 on the remote or holding the **Band Selector** 9 on the front panel pressed for 3 seconds until the **STEREO** indicator V goes out.

Preset Tuning

Using the remote, up to 30 stations may be stored in the AVR5000's memory for easy recall using the front panel controls or the remote.

To enter a station into the memory, first tune the station using the steps outlined above. Then:

1. Press the **Memory** button 29 on the remote. Note that **MEMORY** indicator U will illuminate and flash in the **Main Information Display** 25.
2. Within five seconds, press the **Numeric Keys** 18 corresponding to the location where you wish to store this station's frequency. Once entered, the preset number will appear in the **Preset Number/Sleep Time Display** R.
3. Repeat the process after tuning any additional stations to be preset.

Recalling Preset Stations

- To manually select a station previously entered in the preset memory, press the **Numeric Keys** 18 that correspond to the desired station's memory location.
- To manually tune through the list of stored preset stations one by one, press the **Preset Stations Selector** buttons 10 27 on the front panel or remote.

Operation

RDS Operation

The AVR5000 is equipped with RDS (Radio Data System), which brings a wide range of information to FM radio. Now in use in many countries, RDS is a system for transmitting station call signs or network information, a description of station program type, text messages about the station or specifics of a musical selection, and the correct time.

As more FM stations become equipped with RDS capabilities, the AVR5000 will serve as an easy-to-use center for both information and entertainment. This section will help you take maximum advantage of the RDS system.

RDS Tuning

When an FM station is tuned in and it contains RDS data, the **RDS Indicator AE** will illuminate and the AVR5000 will automatically display the station's call sign or other program service in the **Main Information Display Y**.

RDS Display Options

The RDS system is capable of transmitting a wide variety of information in addition to the initial station call sign that appears when a station is first tuned. In normal RDS operation the display will indicate the station name, broadcast network or call letters. Pressing the **RDS** button **12 26** enables you to cycle through the various data types in the following sequence:

- The station's call letters (with some private stations other information too).
- The station's frequency.
- The Program Type (PTY) as shown in the list below. The **PTY Indicator AD** will illuminate when this data is being received.
- A "text" message (Radiotext, RT) containing special information from the broadcast station. Note that this message may scroll across the display to permit messages longer than the eight positions in the display. Depending on signal quality, it may take up to 30 seconds for the text message to appear; in that time, the word **TEXT** will flash in the Information Display when RT is selected. The **RT Indicator AB** will illuminate when text data is being received and ready to be displayed.

- The current time of day (CT). Note that it may take up to two minutes for the time to appear, in that time the word **TIME** will flash in the information display when CT is selected. The **CT Indicator AC** will illuminate when time data is being received. Please note that the accuracy of the time data is dependent on the radio station, not the AVR5000.

Some RDS stations may not include some of these additional features. If the data required for the selected mode is not being transmitted, the **Main Information Display Y** will show a **NO TYPE, NO TEXT** or **NO TIME** message after the individual time out.

In any FM mode the RDS function requires a strong enough signal for proper operation. If you receive a partial message, or any of the **RDS, PTY, CT** or **RT Indicators AE AD AC AB** going on and off, try slowly adjusting the antenna or tune to another stronger RDS station.

Program Search (PTY)

An important feature of RDS is its capability of encoding broadcasts with Program Type (PTY) codes that indicate the type of material being broadcast. The following list shows the abbreviations used to indicate each PTY, along with an explanation of the PTY:

- **(RDS ONLY)**
- **(TRAFFIC)**
- **NEWS:** News
- **AFFAIRS:** Current Affairs
- **INFO:** Information
- **SPORT:** Sports
- **EDUCATE:** Educational
- **DRAMA:** Drama
- **CULTURE:** Culture
- **SCIENCE:** Science
- **VARIED:** Varied Speech Programs
- **POPM:** Popular Music
- **ROCKM:** Rock Music
- **M-O-R-M-:** Middle-of-the-Road Music
- **LIGHTM:** Classical Music
- **CLASSICS:** Serious Classical Music
- **OTHERM:** Other Music
- **WEATHER:** Weather Information
- **FINANCE:** Financial Programs
- **CHILDREN:** Children's Programs
- **SOCIAL A:** Social Affairs Programs
- **RELIGION:** Religious Broadcasts
- **PHONE IN:** Phone-In Programs
- **TRAVEL:** Travel and Touring
- **LEISURE:** Leisure and Hobby

Operation

- **JAZZ**: Jazz Music
- **COUNTRY**: Country Music
- **NATIONAL**: National Music
- **OLDIES**: Oldies Music
- **FOLK M**: Folk Music
- **DOCUMENT**: Documentary Programs
- **TEST**: Emergency Test
- **ALARM**: Emergency Broadcast Information

You may search for a specific Program Type (PTY) by following these steps:

1. Press the **RDS** button **12 26** until the current PTY is shown in the **Main Information Display Y**.
2. While the PTY is shown, press the **Preset Up/Down** button **10 27** or hold them pressed to scroll through the list of available PTY types, as shown above. To simply search for the next station transmitting any RDS data, use the **Preset Up/Down** button **10 27** until **RDS ONLY** appears in the display.
3. Press any of the **Tuning Up/Down** buttons **8 21**, the tuner begins to scan the FM band upwards or downwards for the first station that has RDS data that matches the desired selection, and acceptable signal strength for quality reception.
4. While the **PTY Indicator AD** flashes in the display, the tuner will make up to one complete scan of the entire FM band for the next station that matches the desired PTY type and has acceptable reception quality. If no such station is found, the display will read **NONE** for some seconds and the tuner will return to the last FM station in use before the search.

NOTE: Many stations do not transmit a specific PTY. The display will show **NONE**, when such a station is selected and PTY is active.

NOTE: Some stations transmit constant traffic information. To identify as traffic station, they transmit a specific traffic code constantly, which causes the **TA Indicator AA** to light in the display. These stations can be found by selecting **TRAFFIC**, the option in front of **NEWS** in the list. The AVR5000 RDS will find the appropriate station, even if it is not broadcasting traffic information when the search is made.

Advanced Features

The AVR5000 is equipped with a number of advanced features that add extra flexibility to the unit's operation. While it is not necessary to use these features to operate the unit, they provide additional options that you may wish to use.

Display Brightness

The AVR5000's front panel **Main Information Display 25** is set at a default brightness level that is sufficient for viewing in a normally lit room. However, in some home theater installations, you may wish to occasionally lower the brightness of the display, or turn it off completely.

To change the display brightness setting for a specific listening session, you will need to make an adjustment in the **ADVANCED SELECT** menu. To start the adjustment, press the **OSD** button **22** to bring the **MAS-TER MENU** to the screen. Press the **▲** Button **14** twice, until the on-screen **▶** cursor is next to the **ADVANCED** line. Press the **Set** Button **16** to enter the **ADVANCED SELECT** menu (Figure 9).

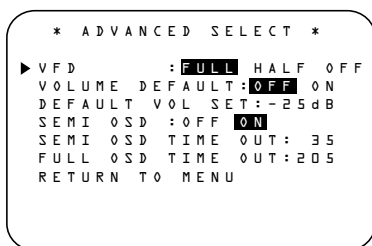

Figure 9

To change the brightness setting, at the **ADVANCED SELECT** menu, make certain that the on-screen **▶** cursor is next to the **VFD** line, and press the **▶** Button **31** until the desired brightness level is highlighted in the video display. When **FULL** is highlighted, the display is at its normal brightness. When **HALF** is highlighted, the display is at half the normal brightness level. When **OFF** is highlighted, all of the indicators in the **Main Information Display 25** will go dark. Note, however, that the green LEDs for the **Input Indicators 22** and the **Surround Mode Indicators 29**, as well as for the **Power Indicator 3**, will always remain lit to remind you that the unit is turned on.

If you wish to make other adjustments in the menu, press the **▲/▼** Buttons **14** until the on-screen **▶** cursor is next to the desired setting or the **RETURN TO MENU** line and press the **Set** button **16**. If you have no other adjustments to make, press the **OSD** Button **22** to exit the menu system.

The display brightness may also be changed by pressing and holding the **Set** button **21** on the front for three seconds until the message in the **Main Information Display Y** reads **VFD FULL**. Within five seconds, press the front panel **Selector** buttons **5** until the desired brightness display level is shown. At that point, press the **Set** button **21** again to enter the setting.

Once the desired brightness level is selected, it will remain in effect until it is changed again or until the unit is turned off.

Turn On Volume Level

As is the case with most audio/video receivers, when the AVR5000 is turned on, it will always return to the volume setting in effect when the unit was turned off. However, you may prefer to always have the AVR5000 turn on at a specific setting, regardless of what was last in use when the unit was turned off. To change the default condition so that the same volume level is always used at turn-on, you will need to make an adjustment in the **ADVANCED SELECT** menu. To start the adjustment, press the **OSD** button **22** to bring the **MAS-TER MENU** (Figure 1) to the screen. Press the **▲** button **14** twice, until the on-screen **▶** cursor is next to the **ADVANCED** line. Press the **Set** button **16** to enter the **ADVANCED SELECT** menu (Figure 9).

At the **ADVANCED SELECT** menu make certain that the on-screen **▶** cursor is next to the volume default line by pressing the **▲/▼** buttons **14** as needed. Next, press the **▶** button **31** so that the word **ON** is highlighted in the video display. Next, press the **▼** button **14** once so that the on-screen **▶** cursor is next to the **DEFAULT VOL SET** line. To set the desired turn-on volume, press the **◀▶** buttons **15 31** or hold them pressed until the desired volume level is shown on the **DEFAULT VOL SET** line. Note that this setting may NOT be made with the regular volume controls.

NOTE: Since the setting for the turn-on volume cannot be heard while the setting is being made, you may wish to determine the setting before making the adjustment. To do this, listen to any source and adjust the volume to the desired level using the regular volume controls **20 34 1**. When the desired volume level to be used at turn-on is reached, make a note of the setting as it appears in the lower third of the video screen or in the **Main Information Display Y** (a typical volume level will appear as a negative number such as -25dB). When making the adjustment, use the **◀▶** buttons **15 31** to enter this setting.

Unlike some of the other adjustments in this menu, the turn-on volume default will remain in effect until it is changed or turned off in this menu, even when the unit is turned off completely.

If you wish to make other adjustments in the menu, press the **▲/▼** Buttons **14** until the on-screen **▶** cursor is next to the desired setting or the **RETURN TO MENU** line and press the **Set** button **16**. If you have no other adjustments to make, press the **OSD** Button **22** to exit the menu system.

Advanced Features

Semi-OSD Settings

The semi-OSD system places one line messages at the lower third of the video display screen whenever the Volume, Input Source, Surround mode or tuner frequency of any of the configuration settings are changed. The semi-OSD system is helpful in that enables you to have feedback on any control changes or remote commands using the video display when it is difficult to view the front-panel displays. However, you may occasionally prefer to turn these displays off for a particular listening session. You may also want to adjust the length of time the displays remain on the screen. Both of those options are possible with the AVR5000.

To turn off the semi-OSD system, you will need to make an adjustment in the **ADVANCED SELECT** menu (Figure 9). To start the adjustment, press the **OSD** button **22** to bring the **MASTER MENU** to the screen. Press the **▲** Button **14** twice, until the on-screen **▼** cursor is next to the **ADVANCED** line. Press the **Set** Button **16** to enter the **ADVANCED SELECT** menu.

At the **ADVANCED SELECT** menu make certain that the on-screen **▶** cursor is next to the **SEMI OSD** line by pressing the **▲/▼** buttons **14** as needed. Next, press the **▶** button **31** so that the word **OFF** is highlighted in the video display.

Note that this setting is temporary and will remain active only until it is changed or until the AVR5000 is turned off. Once the unit is turned off, the semi-OSD displays will remain activated, even if they were switched off for the previous listening session.

To change the length of time that the semi-OSD displays remain on the screen, go to the **ADVANCED SELECT** Menu as outlined earlier, and press the **▲/▼** buttons **14** as needed, until the on-screen **▶** cursor is next to the **SEMI - OSD TIME OUT** line. Next, press the **◀▶** Buttons **15 31** until the desired time in seconds is displayed. Note that unlike most of the other options in this menu, this is a permanent setting change, and the time-out entry will remain in effect until it is changed, even when the unit is turned off.

If you wish to make other adjustments in the menu, press the **▲/▼** Buttons **14** until the on-screen **▶** cursor is next to the desired setting or the **RETURN TO MENU** line and press the **Set** button **16**. If you have no other adjustments to make, press the **OSD** Button **22** to exit the menu system.

Full-OSD Time Out Adjustment

The **FULL - OSD** menu system is used to simplify the setup and adjustment of the AVR5000 using a series of on-screen menus. The factory default setting for these menus leaves them on the screen for 20 seconds after a period of inactivity before they disappear from the screen or Time Out. This Time Out is a safety measure to prevent the menu text from burning into the CRTs in your monitor or projector, which might happen if they were left on indefinitely. However, some viewers may prefer a slightly longer or shorter period before the Time Out display.

To change the Full-OSD Time Out, you will need to make an adjustment in the **ADVANCED SELECT** Menu (Figure 1). To start the adjustment, press the **OSD** button **22** to bring the **MASTER MENU** to the screen. Press the **▲** button **14** twice, until the on-screen **▼** cursor is next to the **ADVANCED** line. Press the **Set** Button **16** to enter the **ADVANCED SELECT** Menu (Figure 9).

At the **ADVANCED SELECT** menu make certain that the on-screen **▶** cursor is next to the **FULL - OSD TIME OUT** line by pressing the **▲/▼** Buttons **14** as needed. Next, press the **◀▶** buttons **15 31** until the desired time is displayed in seconds. Note that unlike most of the other options in this menu, this is a permanent setting change, and the time-out entry will remain in effect until it is changed, even when the unit is turned off.

If you wish to make other adjustments in the menu, press the **▲/▼** Buttons **14** until the on-screen **▶** cursor is next to the desired setting or the **RETURN TO MENU** line and press the **Set** button **16**. If you have no other adjustments to make, press the **OSD** Button **22** to exit the menu system.

Multiroom Operation

The AVR5000 is fully equipped to operate as the control center for a multiroom system with optional remote external Infrared (IR) sensors, speakers and power amplifiers. Although some multi-room installations will require the services of a specially trained installer, it is possible for the average do-it-yourself hobbyist to install a simple remote room system.

Installation

The key to remote room operation is to link the remote room to the AVR5000's location with wire for an infrared receiver and speakers or an amplifier. For complete installation instructions for Multiroom use, see page 18.

Multiroom Setup

Once the audio and IR link connections have been made, the AVR5000 needs to be configured for multiroom operation using the steps below. Press the **OSD** button **22** to bring the **MASTER MENU** (Figure 1) to the screen. Press the **▲/▼** button **14**, until the on-screen **▶** cursor is next to the **MULTI - ROOM** line. Press the **Set** button **16** to enter the **MULTI - ROOM SETUP** menu (Figure 10).

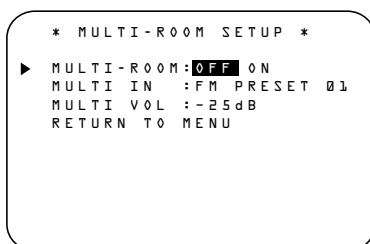

Figure 10

When the **MULTI - ROOM SETUP** menu appears, the on-screen **▶** cursor will be at the **MULTI - ROOM** line. Since this line is used to turn the system on and off, do not make an adjustment here unless you wish to turn the system on at this time. To turn the system on, press the **▶** button **15 31** so that **ON** is highlighted. If you do not wish to turn the system on at this time or to proceed to the next step, press the **▼** Button **14** once so that the **▶** on-screen cursor is next to the **MULTI IN** line.

At the **MULTI IN** line, press the **◀▶** buttons **15 31** until the desired Audio/Video input to the multi-room system appears in the highlighted video. When the selection has been made, press the **▼** button **14** once so that the **▶** on-screen cursor is next to the **MULTI VOL** line.

At the **MULTI VOL** line, press the **◀▶** buttons **15 31** or hold them pressed until the desired volume level for the multi-room system is entered. DO NOT use the regular volume control knobs for this setting. When all settings for the multiroom setup have been made, press the **▼** buttons **14** once so that the on-screen **▶** cursor is next to the **RETURN TO MENU** line and press the **Set** button **16**. If you have no other adjustments to make, press the **OSD** button **22** to exit the menu system.

Multiroom Operation

When operating the AVR5000 from a remote room location where an IR sensor link has been connected to the AVR5000's rear panel **Multiroom IR Input 21**, you may use either the Main remote control or the Zone II remote. To turn on the multiroom feed, press any of the **Input Selector** buttons on the Zone II remote **B C D** or the Main remote **5 6 7**. Press the **AVR Selector 6 B** to turn the unit on to the last source, or any of the other **Selector** buttons to turn on to a specific source.

As long as an IR feed to the AVR5000 has been established from the remote room, using any of the buttons on either remote will control the remote location volume **34 1**, change the tuner frequency **21 E**, change the tuner preset **27 G** or mute the output **33 ●**.

If the **Remote IR Output jack 21** on the AVR5000 is connected to an IR Input jack on compatible Harman Kardon audio components such as CD, DVD or cassette players, the transport functions of those machines may also be controlled using the **Transport Controls 24 E F G H J** on either remote control.

To turn the system off from the remote room, press the **Power-Off** button **4 A**. Remember that the AVR5000 may be turned on or off from the remote room regardless of the system's operation or status in the main room.

NOTE: When the tuner is selected as the source for the remote zone, any change to the frequency or preset will also change the station being listened to in the main room, if the tuner is in use there. Similarly, if someone in the main room changes the station, the change will also impact the remote room.

To activate the feed to the remote room, press the **Multiroom** button **33** on the remote. Next, press the **Set** button **16**. Press the **▲/▼** buttons **14** to turn the multiroom feed on or off. When the multiroom system is on, the **Multi** indicator **P** will light in the **Main Information Display 25**, and the **Main Information Display Y** or OSD will display **MULTI ON**. Press the **Set** button twice **16** to enter the setting.

When the multiroom system is turned on, the input selected using the Multiroom Menu will be fed to the **Multiroom Output jacks 10** on the rear panel. The volume will be as set in the same menu, although it may also be adjusted using an optional IR sensor and the Zone II remote in the remote location or on the optional audio power amplifier connected to the **Multiroom Output jacks 10**.

Once the multiroom system is turned on, it will remain on even if the AVR5000 is placed in the Standby mode in the main room by pressing the **Power Off Button 4** or the **System Power Control 2** on the front panel. To turn off the multiroom system from the main listening room, even when the AVR is in Standby mode, press the **Multiroom** button **33** and then the **Set** button **16**. Press the **▲/▼** buttons **14** so that the **Multi** indicator **P** in the **Main Information Display 25** goes out, and the **Main Information Display Y** or OSD will display **MULTI OFF**.

Even when the AVR is turned off (to Standby mode) and the Multiroom system is turned off too, the multiroom system may be turned on at any time from any room by pressing any of the **Selector** buttons **5 6 7 B C D** on the remote in the remote room.

Programming the Remote

The AVR5000 is equipped with a powerful remote control that will control not only the receiver's functions, but also most popular brands of audio and video equipment, including CD players, TV sets, cable boxes, VCRs, satellite receivers and other home-theater equipment. Once the AVR5000's remote is programmed with the codes for the products you own, it is possible to eliminate most other remotes and replace them with the convenience of a single universal remote control.

Programming the Remote with Codes

As shipped from the factory, the remote is fully programmed for all AVR5000 functions, as well as those of most Harman Kardon CD changers, DVD players, CD players and cassette decks. In addition, by following one of the methods below, you may program the remote to operate a wide range of devices from other manufacturers.

Note: The **Input Selector** button **Video 4** **5** cannot be programmed with codes as it functions as input selector for the AVR only. Moreover, only the default code "001" can be programmed on the **AVR Selector** button **6**.

Direct Code Entry

This method is the easiest way to program your remote to work with different products.

1. Use the tables in the following pages to determine the three-digit code or codes that match both the product type (e.g., VCR, TV), and the specific brand name. If there is more than one number for a brand, make note of the different choices.
2. Turn on the unit you wish to program into the AVR5000 remote.
3. Press and hold both the **Input Selector** **5** for the type of product to be entered (e.g., VCR, TV) and the **Mute** **38** at the same time. When the **Program/SPL Indicator** **3** turns amber and begins flashing, release the buttons. It is important that you begin the next step within 20 seconds.
4. If the unit you wish to program into the AVR5000 remote has a remotable Power on/off function, follow these steps:
 - a. Point the AVR5000's remote towards the unit to be programmed, and enter the first three-digit code number using the **Numeric** buttons **18**. If the unit being programmed turns off, the correct code has been entered. Press the **Input Selector** **5** again, and note that the red light under the **Input Selector** will flash three times before going dark to confirm the entry.

- b. If the product to be programmed does NOT turn off, continue to enter the three-digit code numbers until the equipment turns off. At this point, the correct code has been entered. Press the **Input Selector** **5** again and note that the red light under the **Input Selector** will flash three times before going dark to confirm the entry.

5. If the Power function of the unit to be programmed cannot be remoted, follow these steps (max. 20 seconds after step 3 above, or else step 3 must be repeated first):

- a. Enter the first three-digit code number using the **Numeric** buttons **18** and press the **Input Selector** **5** again. Press the remote button of any transport function remotable with the unit, e.g. **Pause** or **Play** **24**. If the unit being programmed starts that function, the correct code has been entered.
- b. If the unit does not start the function whose button was pressed, repeat steps 3 and 5a above with the next three-digit code number listed in the setup code table for that brand and product type, until the unit reacts properly on the transport function transmitted.

6. Try all of the functions on the remote to make certain that the product operates properly. Keep in mind that many manufacturers use a number of different combinations of codes, so it is a good idea to make certain that not only does the Power control work, but that the volume, channel and transport controls work as they should. If functions do not work properly, you may need to use a different remote code.

7. If the unit does not react to any code entered, if the code for your product does not appear in the tables in this manual, or if not all functions operate properly, try programming the remote with the Auto Search Method.

Note on Using the AVR5000 remote with a Harman Kardon CD Recorder.

As shipped from the factory the remote is programmed for controlling Harman Kardon CD players. But it is able to control most functions of the CD Recorder CDR2 and CDR20 (see function list on page 44) too after the code "002" is entered to the **CD Selector** button **3** as described above. For returning to the CD player control commands the code "001" must be entered.

Auto-Search Method

If the unit you wish to include in the AVR5000's remote is not listed in the code tables in this manual or if the code does not seem to operate properly, you may wish to program the correct code using the Auto Search method that follows. Note that the Auto Search method works only

with units whose Power functions can be remoted:

1. Turn on the product that you wish to include in the AVR5000 remote.

2. Press and hold both the **Input Selector** **5** for the type of product to be entered (e.g., VCR, TV) and the **Mute** **38** button **38** at the same time. When the **Program/SPL Indicator** **3** turns amber and begins flashing, release the buttons. It is important that you begin the next step within 20 seconds.

3. To find out if the code for your unit is pre-programmed, point the AVR5000 remote towards the unit to be programmed, and press and hold the **▲** button **14**. This will send out a series of codes from the remote's built-in data base, with each flash of the red light under the **Input Selector** **5** indicating that a code has been sent. When the device to be programmed turns off, immediately release the **▲** button **14**. Note that it may take one minute or more until the right code is found and the unit turns off.

4. When the **▲** button was not released in time after the unit turned off, the proper code will be "overrun". That's why a function test should be made: Turn the unit on again and, while the **Input Selector** **5** still lights red, press the **▲** button **14** once, than the **▼** button **14** once too. When the unit turns off, the right code was found, when not, the code was "overrun". To re-find the correct, while the **Input Selector** **5** still lights red, press (not hold pressed) the **▼** button **14** repeatedly to step backwards through the codes available and observe the reaction of the unit at each press. As soon as the unit turns off the correct code is found.

5. Press the **Input Selector** **5** again, and note that the red light will flash three times before going dark to confirm the entry.

6. Try all of the functions on the remote to make certain that the product operates. Keep in mind that many manufacturers use a number of different combinations of codes, and it is a good idea to make certain that not only the Power control works, but the volume, channel and transport controls, as appropriate. If all functions do not work properly, you may need to Auto-Search for a different code, or enter a code via the Direct Code Entry method.

Programming the Remote

Code Readout

When the code has been entered using the Auto Search method, it is always a good idea to find out the exact code so that it may be easily reentered if necessary. You may also read the codes to verify which device has been programmed to a specific Control Selector button.

1. Press and hold both the **Input Selector** (5) for the device you wish to find the code for and the **Mute** button (3) at the same time. Note that the **Program/SPL Indicator** (3) will initially turn amber and begin flashing. Release the buttons and begin the next step within 20 seconds.

2. Press the **Set** button (16). The **Program/SPL Indicator** (3) will then blink green in a sequence that corresponds to the three-digit code, with a one-second pause between each digit. Count the number of blinks between each pause to determine the digit of the code. One blink is the number 1, two blinks is the number 2, and so forth. Note that a rapid sequence of three blinks is used to indicate a "0."

Example: One blink, followed by a one-second pause, followed by six blinks, followed by a one-second pause, followed by four blinks indicates that the code has been set to 164.

For future reference enter the Setup Codes for the equipment in your system here:

DVD _____ CD _____

VID1/VCR _____ VID2/TV _____

VID3/CBL/SAT _____

TAPE _____

Learning Codes from a Remote

In addition to using codes from the remote's internal code library, the AVR5000's remote is able to "learn" codes from remotes that may not be in the code library. In addition, you may use this function to "learn over" the codes from a preprogrammed device to add functions not included in the preprogrammed codes. To learn or transfer codes from an IR remote to the AVR5000's remote, follow these steps:

1. Place the front of the original remote with the code being sent so that it is facing the **IR Transmitter Window** (2) on the AVR5000 remote "head-to-head." The remotes should be between 2 and 4cm apart.

2. Select the button on the remote that you wish to use as the device selector for the codes about to be entered. This must be any of the **Input Selectors** (5) (except for VID4).

3. Press the **Input Selector** (5) button chosen and the **Learn** Button (8) at the same time. Hold these buttons until the **Program/SPL Indicator** (3) flashes amber and the light under the device selector button turns red. Release the buttons. It is important that you begin the next step within 20 seconds.

4. Press the button on the AVR5000 remote that you wish to program. Note that the **Program/SPL Indicator** (3) will stop flashing.

Important Note: Codes cannot be taught to all buttons on the remote. The buttons with the following numbers are not learnable (for numbers, see drawing on page 11): 6, 7, 8, 36, 37, 9, 12, 33, 19, 29, 20, 21, 22, 23, 26, 27, 28.

5. As long as the **Program/SPL Indicator** (3) is on, press and hold the button on the original remote that you wish to "teach" into the AVR5000 remote. When the **Program/SPL Indicator** (3) turns green, release the button. Note that the Program Indicator will then begin to flash amber again.

NOTE: If the **Program/SPL Indicator** (3) turns red during Step 5, the programming was not successful. Repeat the steps to see if the code will "take." If the indicator keeps flashing red in step 5, this code cannot be taught.

6. Repeat steps 4 through 5 for each button on the source remote that you wish to transfer to the AVR5000 remote.

7. Once all codes have been transferred from the original source remote to the AVR5000 remote, press the **Learn** button (8). This will turn off all LEDs and turn off the learning mode.

8. Repeat Steps 1 through 7 for any additional remotes you wish to "teach" into the AVR5000 Remote.

Erasing Learned Codes

The AVR5000's remote allows you to remove or erase the code learned into a single button for a single device, to remove or erase all the codes that have been learned for a single device, or to erase all commands that have been learned for all devices.

To erase a single learned code from within a single device's settings, follow these steps:

1. Press and hold both the **Input Selector** (5, 6, 7) within which the individual button to be erased has been programmed and the **Learn** button (8).

2. When the red LED under the **Input Selector** turns red and the **Program/SPL Indicator** (3) flashes amber, release the buttons.

3. Press and release the **Input Selector** (5, 6, 7) again for the device within which the individual button to be erased has been programmed.

4. Press the 7 button (18) three times.

5. Press and release the individual button for which the code is to be erased. The **Program/SPL Indicator** (3) will blink green two times and then return to amber.

6. To erase other buttons within the same device, press them as noted in Step 5.

7. When all buttons to be erased have been pressed, press the **Learn** button (8) to complete the process.

To erase all codes within a single device, follow these steps:

1. Press and hold both the **Input Selector** (5, 6, 7) for which you wish to erase the codes and the **Learn** button (8).

2. When the red LED under the **Input Selector** turns red and the **Program/SPL Indicator** (3) flashes amber, release the buttons.

3. Press and release the same **Input Selector** (5, 6, 7) again for the device whose codes you wish to erase.

4. Press the 8 button (18) three times.

5. The **Program/SPL Indicator** (3) will turn off and the red light under the **Input Selector** will flash on and off once to indicate that the codes have been erased.

Programming the Remote

To erase all codes that have been programmed to all devices in the remote, follow these steps:

1. Press any **Input Selector** ⑤ ⑥ ⑦ and also the **Learn** button ⑧.
2. When the red LED under the **Input Selector** turns red and the **Program/SPL Indicator** ③ flashes amber, release the buttons.
3. Press and release the same **Input Selector** ⑤ ⑥ ⑦ again.
4. Press the 9 button ⑮ three times.
5. The **Program/SPL Indicator** ③ will turn off and the red light under the **Input Selector** will flash on and off once to indicate that the codes have been erased.

Macro Programming

Macros enable you to easily repeat frequently used combinations of commands with the press of a single button on the AVR 5000's remote control. Once programmed, a macro will send out up to 19 different remote codes in a pre-determined sequential order enabling you to automate the process of turning on your system, changing devices, or other common tasks. The AVR's remote can store up to five separate macro command sequences, one that is associated with the **Power On** button ①, and four more that are accessed by pressing the **Macro** buttons ⑳.

1. Press the **Mute** button ㉔ and the **Macro** button ㉑ to be programmed or the **Power-On** button ① at the same time. Note that the latest selected **Input Selector** will light red, and the **Program/SPL Indicator** ③ will flash amber.
2. Enter the steps for the macro sequence by pressing the button for the actual command step. Although the macro may contain up to 19 steps, each button press, including those used to change devices, counts as a step. The **Program/SPL Indicator** ③ will flash green to confirm each button press as you enter commands.

NOTE: While entering commands for Power On of any device during a macro sequence, press the **Mute** button ㉔. DO NOT press the actual Power ON button.

- Remember to press the appropriate **Input Selector** button ⑤ before functions are changed to another device. This is also needed for the **AVR Selector** button ⑥ itself, as long as it's not lit red and AVR functions shall be programmed.

3. When all the steps have been entered, press the **Sleep** button ⑩ to enter the commands. The red light under the **Input Selector** ⑤ ⑥ will blink and then turn off.

Example: To program the **Macro 1** ㉑ button so that it turns on the AVR 5000, TV and a Sat-Receiver, follow these steps:

- Press the **Macro 1** button ㉑ and **Mute** ㉔ buttons at the same time and then release them.
- Note that the **Program/SPL Indicator** will flash amber.
- Press the **AVR Selector** ⑥.
- Press the **Mute** ㉔ button to store the AVR's power on command.
- Press the **VID 2 Input Selector** button ⑤ to indicate the next command is for "TV Power On."
- Press the **Mute** ㉔ button to store the TV Power On Command.

- Press the **VID 3 Input Selector** button ⑤ to indicate the next command is for "Sat-Receiver Power On."
- Press the **Mute** ㉔ button to store the Sat-Receiver Power On command.
- Press the **Sleep/Channel Up** button ⑩ to complete the process and store the macro sequence.

After following these steps, each time you press the **Macro 1** button ㉑, the remote will send all Power On commands.

Erasing Macro Commands

To remove the commands that have been programmed into one of the Macro buttons, follow these steps:

1. Press the **Mute** button ㉔ and the **Macro** button ㉑ that contains the commands you wish to erase.
2. Note that the **Program/SPL Indicator** ③ will flash amber, and the LED under the **AVR Selector** ⑥ will turn red.
3. Within ten seconds, press the **Surround Mode Selector/Channel Down** button ⑪.
4. The red LED under the **AVR Selector** will go out, and the **Program/SPL Indicator** ③ will turn green and flash three times before it goes out.
5. When the **Program/SPL Indicator** ③ goes out, the Macro has been erased.

Programming the Remote

Programmed Device Functions

Once the AVR5000's remote has been programmed for the codes of other devices, press the appropriate **Input Selector** ⑤ to change the remote from control over the AVR5000 to the additional product. When you press any of these buttons, it will briefly flash in red to indicate that you have changed the device being controlled.

When operating a device other than the AVR5000, the controls may not correspond exactly to the function printed on the remote or button. Some commands, such as the volume control, are the same as they are with the AVR5000. Other buttons will change their function so that they correspond to a secondary label on the remote. For example, the Sleep and Surround mode selector buttons also function as the Channel Up and Channel Down buttons when operating most TV sets, VCRs or Sat-Receivers.

For some products, however, the function of a particular button does not follow the command printed on the remote. In order to see which function a button controls, consult the Function List tables printed on page 44. To use those tables, first check the type of device being controlled (e.g., TV, VCR). Next, look at the remote control diagram on page 44. Note that each button has a number on it.

To find out what function a particular button has for a specific device, find the button number on the Function List and then look in the column for the device you are controlling. For example, button number 54 is the Macro 2 button for the AVR5000, but it is the "Favorite" button for many cable television boxes and satellite receivers. Button number 32 is the Delay button for the AVR5000, but the Open/Close button for CD players.

Note that the numbers used to describe the button functions at the left for the purposes of describing how a button operates are a different set of numbers than those used in the rest of this manual to describe the button functions for the AVR 5000.

Notes on Using the AVR5000 Remote With Other Devices.

- Manufacturers may use different code sets for the same product category. For that reason, it is important that you check to see if the code set you have entered operates as many controls as possible. If it appears that only a few functions operate, check to see if another code set will work with more buttons.
- Depending on the brand and product type used the functions listed in the Function List tables may not correspond with the function the unit reacts on the command. In these cases it's a good idea to edit the reaction of the unit into the corresponding line of the table or to set up a separate list.
- When a button is pressed on the AVR5000 remote, the red light under the **Input Selector** ⑤ for the product being operated should flash briefly. If the Device Control Selector flashes for some but not all buttons for a particular product, it does NOT indicate a problem with the remote, but rather that no function is programmed for the button being pushed.
- The remote was pre-programmed with codes for units of the latest generation, but some codes may differ from those needed for earlier units. When your device doesn't react as listed in the function list (page 44/45), let the AVR5000 remote learn the appropriate codes from the original remote (learning codes see page 40).

Volume Punch-Through

The AVR5000's remote may be programmed to operate the **Volume Control** ③④ and the **Mute** ③⑧ from either the TV or the AVR in conjunction with any of the six devices controlled by the remote. For example, since the AVR5000 will likely be used as the sound system for TV viewing, you may wish to have the AVR's volume activated although the remote is set to run the TV.

To program the remote for Volume Punch-Through, follow these steps:

1. Press the **Input Selector** ⑤ for the unit you wish to have associated with the volume control and the **Mute** button ③⑧ at the same time until the red light illuminates under the **Input Selector** ⑤ and note that the **Program/SPL Indicator** ③ will flash amber.
2. Press the **Volume Up** button ③④ and note that the **Program/SPL Indicator** ③ will stop flashing and stay amber.
3. Press either the **AVR Selector** ⑥ or the **Input Selector** ⑤, depending on which system's volume control you wish to have attached for the punch-through mode. The **Program/SPL Indicator** ③ will blink green three times and then go out to confirm the data entry.

Example: To have the AVR's volume control activated even though the remote is set to control the TV, first press the **Video/TV Input Selector** ⑤ and the **Mute** button ③⑧ at the same time. Next, press the **Volume Up** button ③④, followed by the **AVR Input Selector** ⑥.

NOTE: Should you wish to return the remote to the original configuration after entering a Volume Punch-Through, you will need to repeat the steps shown above. However, press the **Video/TV Input Selector** in steps one and three.

Programming the Remote

Channel Control Punch-Through

The AVR 5000's remote may be programmed to operate so that the channel control function for either the TV, cable or satellite receiver used in your system may be used in conjunction with one of the other devices controlled by the remote. For example, while using and controlling the VCR, you may wish to change channels on a cable box or satellite receiver without having to change the device selected by the AVR 5000 or the remote. To program the remote for Channel Control Punch-Through, follow these steps:

1. Press the **Input Selector** button **5** for the device you wish to have the channel control associated with and the **Mute** button **38** at the same time until the red light illuminates under the **Input Selector** **5** and the **Program/SPL Indicator** **3** flashes amber.

2. Press the **Volume Down** button **34**. The **Program/SPL Indicator** **3** will stop flashing and stay amber.

3. Press and release the **AVR** **6** or **Input Selector** button **5** for the device that will be used to change the channels. The **Program/SPL Indicator** **3** will blink green three times and then go out to confirm the data entry.

Example: To control the channels using your TV while the remote is set to control the VCR, first press the **VID 1/VCR Input Selector** button **5** and the **Mute** button **38** at the same time. Next, release them and press the **Volume Down** button **34**, followed by the **VID 2/TV Input Selector** button **5**.

NOTE: To remove the Channel Control Punch-Through and return the remote to its original configuration, repeat the steps shown in the example above. However, press the **VID 1/VCR Input Selector** in Steps 1 and 3.

Transport Control Punch-Through

The AVR 5000's remote may be programmed to operate so that the Transport Control Functions **24** (Play, Stop, Fast Forward, Rewind, Pause and Record) for a VCR, DVD or CD will operate in conjunction with one of the other devices controlled by the remote. For example, while using and controlling the TV, you may wish to start or stop your VCR or DVD without having to change the device selected by the AVR 5000 or the remote. To program the remote for Transport Control Punch-Through, follow these steps:

1. Press the **Input Selector** **5** for the device you wish to have the channel control associated with and the **Mute** button **38** at the same time until the red light illuminates, under the **Input Selector** **5** and the **Program/SPL Indicator** **3** flashes amber.

2. Press the **Play** button **24**. The **Program/SPL Indicator** **3** will stop flashing and stay amber.

3. Press and release the **AVR** **6** or **Input Selector** button **5** for the device that will be used to change the channels. The **Program/SPL Indicator** **3** will blink green three times and then go out to confirm the data entry.

Example: To control the transport of a CD player while the remote is set to control the TV, press the **VID 2/TV Input Selector** button **5** and the **Mute** button **38** at the same time. Next, release them and press the **Play** button **24**, followed by the **CD Input Selector** button **5**.

NOTE: To remove the Channel Control Punch-Through and return the remote to its original configuration, repeat the steps shown in the example above. However, press the **VID 2/TV Input Selector** in Steps 1 and 3.

NOTE: Before programming the remote for Volume, Channel or Transport Punch-Through, make certain that any programming needed for the specific TV, CD, DVD, Cable or Satellite Receivers has been completed.

Reassigning Device-Control Selectors

Although any of the **Input Selectors** **5** is normally assigned to the category of product shown on the remote, it is possible to reassign one of these buttons to operate a second device of another type. For example, if you have two VCRs but no cable box receiver, you may program the **CBL/SAT** **5** button to operate a second VCR. Before following the normal programming steps for either Three-Digit entry or Auto Search code entry, you must first reassign the button with the following steps:

1. Press the **Input Selector** **5** you wish to reassign and the **Mute** button **38** at the same time until the red light illuminates under the **Input Selector** **5** and the **Program/SPL Indicator** **3** flashes amber.

2. Press the **Input** or **Video Device Selector** **5** for the device, whose function you wish to program into the reassigned button.

3. Enter the three-digit code for the specific model you wish the reassigned button to operate.

4. Press the same **Input Selector** **5** pressed in Step 1 once again to store the selection. The red LED under the re-assigned Input Selector will flash three times and then go out.

Example: To use the CBL/SAT button to operate a second VCR, first press the **CBL/SAT Input Selector** **5** and the **Mute** button **38** at the same time until the red light glows under the

CBL/SAT **5** button. Press the **VCR** **5** button, followed by the three-digit code for the specific model you wish to control. Finally, press the **CBL/SAT** **5** button again.

Resetting the Remote Memory

As you add components to your home-theater system, occasionally you may wish to totally reprogram the remote control without the confusion of any commands, macros or "Punch-Through" programming that you may have done. To do this, it is possible to reset the remote to the original factory defaults and command codes by following these steps. Note, however, that once the remote is reset, all commands or codes that you have entered will be erased and will need to be re-entered:

1. Press any of the **Input Selector** buttons **5** and the **"0"** button **18** at the same time until the **Program/SPL Indicator** **3** begins to flash amber.

2. Press the **"3"** button **18** three times.

3. The red LED under the **Input Selector** **5** will go out and the **Program/SPL Indicator** **3** will stop flashing and turn green.

4. The **Program/SPL Indicator** **3** will remain green until the remote is reset. Note that this may take a while, depending on how many commands are in the memory and need to be erased.

5. When the **Program/SPL Indicator** **3** goes out, the remote has been reset to the factory settings.

Function List

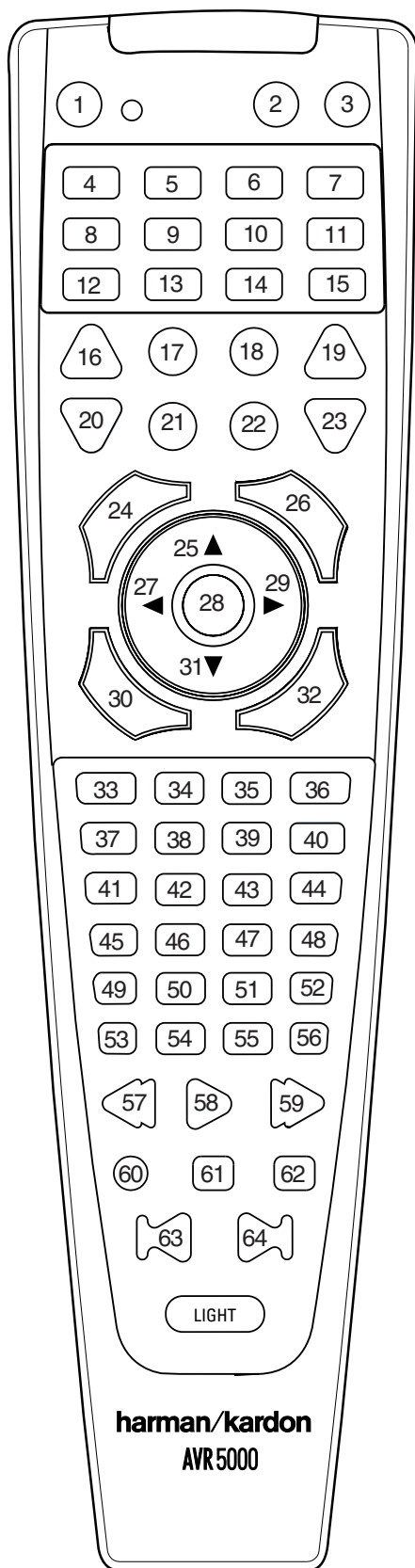

No.	Button Name	AVR Function	DVD	CD/CDR
1	Power Off	Power Off	Power Off	Power Off
2	Power On	Power On	Power On	Power On
3	Mute	Mute		
4	AVR	AVR Select		
5	DVD	DVD Input Select	DVD Select	
6	CD	CD Input Select		CD Select
7	Tape	Tape Input Select		
8	VID 1	Video 1 Select		
9	VID 2	Video 2 Select		
10	VID 3	Video 3 Select		
11	VID 4	Video 4 Select		
12	Learn			
13	AM/FM	Tuner Select		
14	6 Ch. Select	6 Ch Input Select		
15	SPL	SPL		
16	Sleep	Sleep		
17	Test	Test Tone		
18	TV		TV/DVD	-/CDP Select
19	Volume Up	Volume Up	Volume Up	
20	Surround Select	Surround Mode Select		-/CDR Select
21	Night	Night Mode Select	Subtitle on/off	
22	Multi Room	Multi-Room Select	Sub on/off	
23	Volume Down	Volume Down	Volume Down	
24	Channel/Guide	Channel Trim	Title	
25	▲	Move/Adjust Up	Up	
26	Speaker/Menu	Speaker Adjust	Menu	Intro/-
27	◀	Move/Adjust Left	Left	
28	Set	Set	Enter	
29	▶	Move/Adjust Right	Right	
30	Digital/Exit	Digital Input Select	Open/Close	
31	▼	Move/Adjust Down	Down	
32	Delay/Prev. Ch.	Delay Adjust	Return	Open/Close
33	1	1	1	1
34	2	2	2	2
35	3	3	3	3
36	4	4	4	4
37	5	5	5	5
38	6	6	6	6
39	7	7	7	7
40	8	8	8	8
41	Tun-M	Tuner Mode	Chapter	Repeat
42	9	9	9	9
43	0	0	0	0
44	Memory	Memory	Audio	Time/CDR Display
45	Tune Up	Tune Up		
46	Direct	Direct Tuner Entry	Angle	Random
47	Clear	Clear	Clear	Clear
48	Preset Up	Preset Tune Up	Slow Forward	+10/-
49	Tune Down	Tune Down		-/Track Increment
50	OSD	OSD		
51	D. Skip		Disc Skip	Disc Skip
52	Preset Down	Preset Tune Down	Slow Rev	
53	M1			
54	M2			
55	M3			
56	M4			
57	Rewind		R. Search	R. Search
58	Play		Play	Play
59	Fast Forward		F. Search	F. Search
60	Record			-/Record
61	Stop		Stop	Stop
62	Pause		Pause	Pause
63	Skip Down		Skip -	Skip -
64	Skip Up		Skip +	Skip +

Function List

No.	Button Name	Tape	VCR (VID 1)	TV (VID 2)	CBL (VID 3)	SAT(VID 3)
1	Power Off	Power Off	Power Off	Power Off	Power Off	Power Off
2	Power On	Power On	Power On	Power On	Power On	Power On
3	Mute			Mute		
4	AVR					
5	DVD					
6	CD					
7	Tape	Tape Select				
8	VID 1		VCR Select			
9	VID 2			TV Select		
10	VID 3				VID 3 Select	
11	VID 4					
12	Learn					
13	AM/FM					
14	6 Ch. Select					
15	SPL					
16	Sleep		Channel +	Channel +	Channel +	Channel +
17	Test					
18	TV		TV/VCR	TV/VCR	TV/Cable	TV/Sat
19	Volume Up		Volume Up	Volume Up		
20	Surround Select		Channel -		Channel -	Channel -
21	Night					
22	Multi Room					
23	Volume Down			Volume Down		
24	Channel/Guide				Info/Guide	Info/Guide
25	▲		Up	Up	Up	Up
26	Speaker/Menu		Menu	Menu	Menu	Menu
27	◀		Left	Left	Left	Left
28	Set		Enter	Enter	Enter	Enter
29	▶		Right	Right	Right	Right
30	Digital/Exit		Exit	Exit	Exit	Exit
31	▼		Down	Down	Down	Down
32	Delay/Prev. Ch.			Prev Channel	Prev Channel	Prev Channel
33	1		1	1	1	1
34	2		2	2	2	2
35	3		3	3	3	3
36	4		4	4	4	4
37	5		5	5	5	5
38	6		6	6	6	6
39	7		7	7	7	7
40	8		8	8	8	8
41	Tun-M					
42	9		9	9	9	9
43	0		0	0	0	0
44	Memory					
45	Tune Up					
46	Direct					
47	Clear		Clear	Clear	Clear	Clear
48	Preset Up					
49	Tune Down					
50	OSD		OSD	OSD	OSD	OSD
51	D. Skip					
52	Preset Down					
53	M1		Cancel	Sleep	PPV	Cancel
54	M2				Fav	Fav
55	M3				Bypass	Next
56	M4				Music	Alt
57	Rewind	Rewind	Rewind		Day -	Say -
58	Play	Play	Play			
59	Fast Forward	Fast Fwd	Fast Fwd		Day +	Day +
60	Record	Record/Rec.Pause	Record			
61	Stop	Stop	Stop			
62	Pause		Pause			
63	Skip Down		Scan -		Page -	Page -
64	Skip Up		Scan +		Page +	Page +

Setup Code Table: TV

Maker (Brand) Name	Code Number (3digit) List																	
AIWA	340	341																
AKAI	019	049	050	063	102	123	133	139	141	150	174	182	195	209	225	281	288	
ALBA	044	049	050	123	134	163	179	184	195	225	228	239						
AMSTRAD	004	011	195															
ARC EN CIEL	029	034	074	182	186													
ARCAM	029	272																
ASTRA	195																	
ATLANTIC	050	113	236	242	272													
AUDIOSONIC	031	076	195															
BANG & OLUFSEN	279																	
BARCO	310	326	327															
BEKO	063	184	240	241														
BLAUPUNKT	019	053	057	060	113	118	244	245	246	248	249	263						
BRANDT ELECTRONIQUE	029	034	074	182	186													
BRION VEGA	065	083	167	173	181	196	311											
BRIONVEGA	279																	
BRITANNIA	272																	
BRUNS	056	065	279															
BSR	094	110	139	168	269													
BUSH	006	018	049	123	134	139	142	143	179	195	223	225	226	239	262	287		
BUSH(UK)	107	147	168															
CGE	002	044	054	090	093	094	096	139	142	163	168	189	309	324				
CLATONIC	076	123																
CONDOR	050	113	272															
CROWN	154																	
CTC CLATRONIC	045																	
DAEWOO	063	140	145	161	193	195												
DECCA(UK)	046	050	102	106	131													
DUAL	050	095	139	156	168	243												
DUAL-TEC	040	050	168	195														
DUMONT	045	065	080	139	146	274	279	294	296	308	330							
DUMONT-FINLUX	020	045	061	075	078	091	104	117	147									
DYNATRON	049	063																
ELBE	121	194	292	323	324													
ELTA	195																	
EMERSON	004	044	065	279	282													
EUROPHON	044	045	046	050	068	120	168	273	291									
EXPERT	242																	
FERGUSON	001	032	050	073	074	076	080	082	102	103	121	158	204	244				
	245	246	251	258	261	274	276	277	283	284	290	299	304					
FIDELITY(UK)	133	304																
FINLANDIA	033	122	223	262														
FINLUX	003	020	045	061	075	078	080	090	091	104	117	139						
	146	147	163	197	235	274	279	294	296	308	330							
FISHER	050	056	065	069	104	117	139	143	156	189	206	275	279					
FUJITSU	282																	
FUNAI	076	094	269	282														
GEC	104	120	171	262														
GEC(UK)	046	050	102	107	150	162	192											
GOLDSTAR	050	055	063	107	139	152	155	168	195	202	203	219	254	272				
GOODMANS	018	063	102	139	143	155												
GORENJE	124	189																
GRAETZ	090	104	136	139	153	159	162	171	198	262								
GRANADA	018	033	063	102	104	105	112	120	148	171	209	237	238	240	241	262	280	318
GRANADA(UK)	046	050	090	107	139	143	162	262										
GRUNDIG	005	019	053	080	090	101	115	118	166	244	245	246	247	248	249	263	295	296

Setup Code Table: TV (continued)

Maker (Brand) Name	Code Number (3digit) List
HANSEATIC	018 049 050 063 104 107 113 143
HIFIVOX	029 034 074 182 186 259
HITACHI	007 009 018 020 023 033 050 074 086 104 107 110 126 127 139 143 150 162 168 171 176 182 185 186 192 212 218 231 259 262 264 270 288 289 299 316
IMPERIAL	002 044 054 090 093 094 142 163 168 189 262 309 324
INTERVISION	342 343 344 345 346 347 348 349 350 351 352 353
INTERFUNK	049 063 065 074 090 104 112 139 150 153 159 182 256 262 279 318
ITT	090 117 134 139 150 157 162 171 193 198 209 256 262 287 298 305
ITT-NOKIA	090 097 104 117 134 136 139 150 153 159 162 171 172 185 193 198 209 256 262 287 298 305
JVC	018 103 123 129 143 158 170 174 182 225 287 319
KARCHER	003 020 031 050 068 107 195 207 217
KATHREIN	124
KENDO	044 045
KORTING	027 065 094 113 279
LOEWE	089
LOEWE OPTA	035 046 049 052 063 065 120 144 213 279
LUXOR	050 090 107 122 127 133 139 150 155 159 172 185 209 262 267
MAGNADYNE	045 046 047 062 065 104 120 139 150 168 265 273 279
MARANTZ	063
MARELLI	279
METZ	019 051 053 065 067 070 092 118 169 244 245 246 279
MINERVA	019 053 080 090 118 244 245 246 248 249 295 296
MITSUBISHI	013 018 019 021 049 063 065 105 124 131 132 143 157 164 183 244 245 246 252 266 281 285 286 287
MULTITECH	031 045 046 050 120 189 195 265
MURPHY(UK)	162
NAD	209
NATIONAL	033 085 104
NEC	018 143 177
NECKERMANN	002 050 065 107 133 139 180 189 250 262 279 312
NOKIA	090 104 117 134 136 139 150 153 157 159 162 171 193 198 209 256 262 287 298 305
NORDMENDE	017 029 034 038 074 083 130 150 165 174 182 186 218 259 262 288 289
OCEANIC	104 108 109 116 139
OCEANIC(F)	150
OPTONICA	190
ORION	004 051 094 131 134 139 150 179 191 195 199 216 269 286 321 322
OSAKI	066 102 123
OTTO VERSAND	018 049 050 053 063 104 107 139 143 244 245 246 250 287 312 317
PANASONIC	016 033 039 085 099 104 135 137 149 150 151 262 270
PATHE' CINEMA	113 121
PATHE' CINEMA(F)	050 168
PATHE' MARCONI	029 034 074 182 186
PHILCO	002 016 044 054 065 090 093 094 104 142 163 168 189 279 309 324
PHILIPS	015 022 049 050 063 065 079 089 111 112 157 158 160 175 188 192 215 217 220 221 250 268 271 272 279 292 297 304 305 318 328 329
PHOENIX	050 075 104 113 148 279
PIONEER	049 063 074 182 209 218 227 262
PROLINE	030 049 102 191 321
PROTECH	063 076 139
QUELLE	003 019 020 037 049 050 053 063 075 078 080 090 091 094 113 115 117 118 131 139 146 147 150 153 155 235 244 245 246 254 256 274 295 296
RADIOLA	050 063 065 079 112 158 160 188 250 297
RADIOMARELLI	045 046 047 062 063 065 104 105 150 168
RANK	147

Setup Code Table: TV (continued)

Maker (Brand) Name	Code Number (3digit) List																		
RBM(UK)	147																		
REDIFFUSION	059	105	139	171	262	266	298												
REDIFFUSION(UK)	150 162																		
REDIFUSION	104 105																		
REX	036	040	063	071	079	095	110	138	171	236	242	243	260	262	278	293			
RFT	354 355 356 357 358 359																		
ROADSTAR	031 195																		
ROTEL	257																		
RTF	056 065																		
SABA	014	017	025	029	034	038	046	065	074	077									
	120	133	178	182	186	218	259	262	279	288	289								
SALORA	033	075	107	127	133	136	139	148	150	153	171	172	185	198	209	256	262	267	
SAMPO	135																		
SAMSUNG	050	063	066	076	102	155	189	195	217	314	315	320							
SANYO	003	018	020	041	050	056	065	102	117	131	143								
	189	198	201	206	209	257	275	280	286	287	306								
SBR	063 112 157 158 192 268 271																		
SCHAUB LORENZ	090 104 136 139 153 159 162 171 198 262																		
SCHNEIDER	031	040	050	063	065	069	079	095	104	112	114	139							
	148	156	158	160	168	188	243	250	262	271	283	297							
SCOTT	282																		
SEG	045 050 056																		
SELECO	036	040	063	071	079	095	110	138	171	236	242	243	260	262	278	293	294	324	
SHARP	018 094 143 190 206 214 257 317 319																		
SIEMENS	003	018	019	023	053	066	113	118	206	244	245	246	247	248	249	257	262		
SILVER	076																		
SINGER	045	047	065	104	279	324													
SONY	012 018 028 131 143 204 208 211 286 312 313 325																		
SOUND WAVE	049 113 163																		
STANDARD	050																		
STERN	036	040	063	071	079	095	110	138	171	236	242	243	260	262	278	293			
TANDBERG	065 078 169 182 259																		
TANDY	050 096 102 123 190 262																		
TEC	040 050 168 243																		
TELEFUNKEN	032	037	064	074	082	178	182	186	187	218	290								
TELETECH	195																		
TELETON	236																		
TENSAI	050 063 117 123																		
THOMSON	008	010	017	029	034	074	134	147	174	182	186	218	230	234	259	264	288	289	
THORN	053 103 158 222 276 304																		
THORN-FERGUSON	032	073	074	076	080	082	103	121	158	178	258	261							
	274	276	277	283	284	290	304	308	312	313	319	330							
TOSHIBA	001 018 128 141 143 147 205 287 296 324																		
TRISTAR	304 319																		
TRIUMPH	004 046 147 235 294																		
UHER	069 080 090 113 147 148 236 242 262																		
ULTRAVOX	044 045 047 050 065 104 133 139 279																		
UNIVERSUM	003	020	076	155	202	235	244	245	246	308	312	330							
VESTEL	125 319																		
VOXSON	065 090 171 262 279																		
WALTHAM	262																		
WATSON	113 244 245 246																		
WATT RADIO	045	050	068	104	121	139	150	265	272	291									
WEGA	018 139 143 279																		
WEGA COLOR	065 088																		
WELTBlick	063																		

Setup Code Table: TV (continued)

Maker (Brand) Name	Code Number (3digit) List
WESTINGHOUSE	063 094 272
WESTON	168
YOKO	050 195
ZANUSSI	036 040 063 071 079 095 110 138 171 236 260 262 278 293

Setup Code Table: VCR

Maker (Brand) Name	Code Number (3 digit) List
AIWA	039 044 055 073 112 116 121 148 152
AKAI	028 035 044 053 070 090 092 103 124 133 149 150 155
AKURA	029 112
ALBA	029 061 073 114 119 120 121 136 144
AMSTRAD	039 107 119 148
ANITECH	155
ARC EN CIEL	044 045 090
ARISTONA	049 091 109
ASTRA	148
ASTRO SOUND	155
ATLANTIC	155
AUDIOSONIC	170 171
BANG & OLUFSEN	044 155
BAUR	054 134 155 156 157 158
BLAUPUNKT	086 091 098 107 109 129 137 140 147
BRANDT ELECTRONIQUE	044 045 090
BRAUN	147
BRION VEGA	160 139
BUSH	028 029 061 073 119 120 121 136 144
BUSH(UK)	134
CANON	147
CONDOR	155
CROWN	009 061 144
CROWN/ONWA	148
DAEWOO	009 061 063 064 068 069 144 155
DECCA	039 044 048 148 155
DECCA(UK)	054
DEGRAAF	015 018 039 049 054 148
DUAL	044 090 128 148 155
DUMONT	015 039 054 148 155
DYNATECH	039 148
ELBE	036 148
ELTA	148
EMERSON	011 032 039 060 062 073 127 148 155
FERGUSON	003 005 044 083 085 090 094 100 104 108 122 130 131 135 138
FINLADIA	015 054
FINLUX	015 018 019 039 044 049 053 054 103 107 143 146 147 148 149 159

Setup Code Table: VCR (continued)

Maker (Brand) Name	Code Number (3 digit) List
FISHER	008 015 019 032 034 160
FUJITSU	148
FUNAI	039 148
GRANADA(UK)	107
GBC(UK)	054 084
GEC	160
GOLDSTAR	036 055 134 148 155
GOODMANS	029 039 042 050 054 055 061 073 144 148 155
GRAETZ	044 045 084 090 106
GRAETZ(ITT)	160
GRANADA	001 015 019 049 109 147 149 155 160 162
GRANADA(UK)	018 054 134 140
GRUNDIG	054 086 091 097 098 099 109 140 143
HANSEATIC	054 134 155 160
HARMAN/KARDON	036
HIFIVOX	044 045 090
HITACHI	018 025 039 044 074 087 090 134 138 149 160
IMPERIAL	039 042 096 148 155
INTERFUNK	054 084 155 160
INTERVISION	148 155
ITT	015 019 042 044 084 090 103 133 139
ITT/NOKIA	149 150 155 160 162
ITT-NOKIA	015 019 042 044 045 084 090 103 106 133 139
JENSEN	044
JVC	001 004 007 010 044 045 047 085 090 112 115 133 135 141
KARCHER	042 054 134 155
KENDO	103
KENWOOD	019 044 047 112
KOENIG	159
KOERTING	155
KUBA	147 148
LLOYD	039 148
LOEWE	065
LOEWE OPTA	054 082 091 109 140 155
LUXOR	103 106 134 149 160
MAGNADYNE	054 155 159 160
MAGNAVOX	060 062
MARANTZ	036 050 054 073 091 109 111 140
MEMOREX	008 015 019 039 049 055 148
METZ	091 098 105 109 140
MINERVA	086 098 109 140
MITSUBISHI	047 053 054 076 098 123 154 155
MULTITECH	021 029 039 054 098 144 148 155
NATIONAL	107
NEC	036 044 047 090
NECKERMANN	011 019 042 044 054 090 109 127 133 134 139 140 155 156 157 158 160
NESCO	148
NOKIA	015 019 042 044 045 084 090 103 106 133 139
NORDMENDE	004 007 010 014 016 020 022 023 037 039 044 045 047 090 095 097 101 102 125 126 128 132 133 141 142
OCEANIC (ITT)	160
OPTONICA	049 050
ORION	011 031 032 033 059 073 078 127 148 155
OSAKI	039 055 148 155
OTTO VERSAND	054 098 134 147 155 156 157 158 159
PALLADIUM	148 160

Setup Code Table: VCR (continued)

Maker (Brand) Name	Code Number (3 digit) List
PANASONIC	017 071 084 088 089 107 129 137 147 148 160
PATHE' MARCONI	044 045 090
PHILIPS	006 041 043 046 049 050 054 065 079 082 091 109 145 146 155
PIONEER	047 054 113 145
PROLINE	039 148
QUELLE	011 042 044 048 054 055 098 107 109 127 139 140
RADIOLA	049 091 109
RCA	060 062
REALISTIC	008 015 019 039 042 049 050 147 148
REDIFFUSION	160
REX	004 007 044 045 090
ROADSTAR	029 042 055 148
SABA	004 007 009 012 013 014 016 022 023 044 045 047 090 102 125 128 132 133 142
SALORA	001 019 053 134 162
SAMSUNG	009 042 054 056 057 060 062 066 067 092 096 150 155
SANSUI	044 047
SANYO	002 008 015 019 040 073 106 149 151 160
SBR	054 079 082
SCHAUB LORENZ	044 045 084 090 106 160
SCHNEIDER	029 039 042 049 054 091 096 109 148 155 160
SEG	042 096 148
SELECO	044 045 090 155
SHARP	049 050 058 075 148
SIEMENS	019 086 091 098 106 109 140
SINGER	155
SONY	039 048 051 052 077 081 156 157 158
SUNSTAR	039 148
SUPERTEC	148 155
SYLVANIA	039 053 148
TANDBERG	032 127
TEAC	039 044 148
TEC	148 155
TECHNICS	107 147
TELEFUNKEN	004 007 016 024 026 038 044 045 090 128 132 133
TELERENT	147 148
TENSAI	148 155
THOMSON	016 020 044 045 047 090 126 128 133 141
THORN	044 085 090 110 135
THORN-FERGUSON	004 022 023 044 083 085 090 094 100 104 108 130 131 133 135 149 155 156 157 158 160 162
TOSHIBA	009 044 045 053 080 090 153 155
TRANSONIC	155
UHER	042 044 096
ULTRAVOX	139 155 159 160
UNITECH	042
UNIVERSUM	147 148 149 155 156 157 158 160
W.WESTINGHOUSE	160
WATSON	155 159
WELTBlick	155
WHITE WESTINGHOUSE	139
YAMAHA	036 044
YOKO	042 098 148 155
ZANUSSI	044 045 090
ZENDER	090

Setup Code Table: CD

Maker (Brand) Name	Code Number (3 Digit) List
AIWA	072 111 118 156 170
AKAI	050 177 184
ARCAM	220
AUDIOMECA	220
BSR	044 064
CALIFORNIA AUDIO	015 109
CAPETRONIC	070
CROWN	042
DENON	187 188 212
FISHER	023 055 057 068
FUNAI	126
GOLDSTAR (LG)	016 087
GRUNDIG	220 224 225 226 227
HAITAI	099 214
HARMAN KARDON	001 002 025 040 054 190 218 219
HITACHI	049 093
JVC	029 176 195 196
KENWOOD	014 020 023 030 062 078 079 148 151 176 178 181
KYOCERA	012
LINN	220
LUXMAN	018 035 077 102
MAGNAVOX	039 051 113
MARANTZ	043 051 058 084 191 192 193
MBL	184 062
MCINTOSH	194
MERIDIAN	220
MISSION	051
MITSUBISHI	032
MITSUMI	152
NAD	013 074 197 198
NAIM	220
NAKAMICHI	199 200 201 225
NEC	021 069
ONKYO	037 038 045 046 171 175 202 203
PANASONIC	015 075 109 119 158 183 204
PHILIPS	039 051 138 149 209
PIONEER	017 036 071 094 096 100 112 123 131 160 161 162 215
PRIMARE	
PROTON	051 210
REALISTIC	049 056 057 058 093 095 104 105 108 164 166
REVOX	220 229
ROTEL	051
SAE	051
SAMSUNG	028
SANSUI	047 051 081 134 157 172
SANYO	033 057 068 082 095 168
SHARP	020 058 073 105 114 151 159 167 180 181
SHERWOOD	003 026 027 041 058 105 133 230 231 232 233 234 235 236 237 238 239 240 241 242 243
SIGNATURE	040
SONY	060 103 115 116 118 132 139 163 205 206 207 208 212 217
T&A	221
TEAC	011 022 048 058 085 086 106 107 110 121 137 146 154
TECHNICS	244 245 246 247 248 249 250
THETA DIGITAL	039
THOMSON	217

Setup Code Table: CD (continued)

Maker (Brand) Name	Code Number (3 Digit) List
THORENS	220
TOSHIBA	013 074 097 151 155 173
UNIVERSUM (QUELLE)	220 222 223
YAMAHA	019 031 053 061 135 169

Setup Code Table: CBL

Maker (Brand) Name	Code Number (3digit) List
BT CABLE	007
CABLETIME	008 011 012 016
CLYDE CABLE VISION	017
DECSAT CANAL	010
FILMNET	018 019 020
FRANCE TELECOM	013 021
GEC	017
JERROLD	001 022
MOVIE TIME	028
NSC	028
PHILIPS	023
PIONEER	002
SALORA	003
SAMSUNG	002 024
SATBOX	004
SCIENTIFIC ATLANTA	005 006 025 026
STS	028
TELESERVICE	011 014
TUDI	027
UNITED CABLE	001
VISIOPASS	009
WESTMINSTER CABLE	007
ZENITH	014

Setup Code Table: SAT

Maker (Brand) Name	Code Number (3digit) List
AIWA	141
AKAI	033
ALBA	001 017 024 056 070 111 115 117 126
AMSTRAD	071 097 128 132
ANKARO	051 121 133
ASTRA	068 098 099
ASTRO	175 176 177 178 179 180 181 182
BLAUPUNKT	038 090
BRUNS	133
BUSH	024 048 056 070 077 106 126
BUSH(UK)	053
CAMBRIDGE	060
CAMBRIDGE ARD200	104
EHOSTAR	016 021 047 050 065 066 072 086 131
ELTASAT	059
FERGUSON	045 048 052 053 063 064 067 077 106 108 111 124
FINLUX	009 010
FTE	080 136 137
FUBA	014 047 121 128 131
G SAT	130
GALAXIS	133
GOLDSTAR	079 107
GOODMANS	111
GRAETZ	088 099
GRANADA	099
GRUNDIG	003 038 053 067 090
HIRSCHMANN	009 038
HITACHI	106 111 120
HUTH	133
IMPERIAL	126
ITT	067 069 099 120 123
ITT-NOKIA	021 067 088 099 120 123
KATHREIN	001 033 080 081 090 091 096 100 110 112 114 118
KOSMOS	080
LEMON	161
LENCO	079
LOEWE	174
LORENZEN	160 161 162 163 164
LUXOR	043 088 095 099 120 123 125 129 130 131
MARANTZ	033
MASPRO	002 049 053 093 096 106 108 113
METZ	090
MINERVA	090
MITSUBISHI	090
MULTISTAR	080
NEC	030 036 046 073
NOKIA	067 088 099 105 120 123
NORSAT	046
OTTO VERSAND	090
PACE	011 048 053 063 064 067 124
PACE MSS SERIES	067
PANASONIC	031 124
PHILIPS	019 032 033 053 121 124
PTT TELECOM	041
QUADRAL	165 166 167 168 169 170 171 172 173
QUELLE	090

Setup Code Table: SAT (continued)

Maker (Brand) Name	Code Number (3digit) List
RADIOLA	053
RADIX	047
SAKURA	054 057
SALORA	034 068 088 095 099 120 130 131
SAMSUNG	080 127 132
SAT	127
SCHAUB LORENZ	088 099
SCHNEIDER	053
SIEMENS	038 090
SKY MASTER	133
SKYLAB	121
TANDBERG	008
TANDY	085 122
TECHNISAT	005 006 028 047 084 102 103
TELECOM	041
TELEFUNKEN	083
THORN-FERGUSON	023 045 048 052 053 063 064 067
VORTEC	082 083 132 142
WISI	004 022 026 027 047 123 127 131
ZEHNDER	080 127
ZENITH	044

Setup Code Table: DVD

Maker (Brand) Name	Code Number (3 Digit) List
CALIFORNIA AUDIO	040
DENON	002 019 022 034
GE	003 004
GOLDSTAR (LG)	005
HARMAN KARDON	001 032
JVC	006
KENWOOD	007
MAGNAVOX	009 033
MARANTZ	033
MITSUBISHI	023 036
NAD	010
ONKYO	015
PANASONIC	024 025 034 035
PHILIPS	033
PIONEER	012 020 038 041 042
RUNCO	027
SAMSUNG	031
SANYO	013
SHARP	021 028
SONY	014 029
TECHNICS	026
THOMSON	003 004 051
TOSHIBA	033
YAMAHA	016 017 030

Troubleshooting Guide

SYMPTOM	CAUSE	SOLUTION
Unit does not function when Main Power Switch is pushed	<ul style="list-style-type: none"> No AC Power 	<ul style="list-style-type: none"> Make certain AC power cord is plugged into a live outlet Check to see if outlet is switch controlled
Display lights, but no sound or picture	<ul style="list-style-type: none"> Intermittent input connections Mute is on Volume control is down 	<ul style="list-style-type: none"> Make certain that all input and speaker connections are secure Press Mute button Turn up volume control
Sound is heard, but Front-Panel Display does not light	<ul style="list-style-type: none"> Display brightness is turned off 	<ul style="list-style-type: none"> Follow the instructions in the Display Brightness section on page 36 so that the display is set to VFD FULL
No sound from any speaker; light around power switch is red	<ul style="list-style-type: none"> Amplifier is in protection mode due to possible short Amplifier is in protection mode due to internal problems 	<ul style="list-style-type: none"> Check speaker-wire connections for shorts at receiver and speaker ends Contact your local Harman Kardon service depot
No sound from surround or center speakers	<ul style="list-style-type: none"> Incorrect surround mode Incorrect configuration Stereo or Mono program material Speakers not properly connected 	<ul style="list-style-type: none"> Select a mode other than Stereo Check speaker mode With (analog or digital) Dolby surround modes, the surround decoder may not create rear-channel information from nonencoded programs Check speaker-wire connections or use test tone to verify connections (see page 25)
Unit does not respond to remote commands	<ul style="list-style-type: none"> Weak batteries in remote Wrong device selected Remote sensor is obscured 	<ul style="list-style-type: none"> Change remote batteries Press the AVR selector Make certain front-panel sensor is visible to remote or connect remote sensor
Intermittent buzzing in tuner	<ul style="list-style-type: none"> Local interference 	<ul style="list-style-type: none"> Move unit or antenna away from computers, fluorescent lights, motors or other electrical appliances
Letters flash in the Channel Indicator Display and Digital Audio stops	<ul style="list-style-type: none"> Digital audio feed paused 	<ul style="list-style-type: none"> Resume play for DVD Check that Digital Signal is fed to the Digital Input selected
HDCD encoded disc does not trigger HDCD indicator	<ul style="list-style-type: none"> Surround mode in use Analog feed in use 	<ul style="list-style-type: none"> Select "Surround Off" mode Connect and select digital connection to CD player

Processor Reset

In the rare case where the unit's operation or the displays seem abnormal, the cause may involve the erratic operation of the system's memory or microprocessor.

To correct this problem, first unplug the unit from the AC wall outlet and wait at least three minutes. After the pause, reconnect the AC power cord and check the unit's operation. If the system still malfunctions, a system reset may clear the problem.

To clear the AVR5000's entire system memory including tuner presets, output level settings, delay times and speaker configuration data, first put the unit in Standby by pressing the **System Power Control** button **2**. Next, press the **Tone Mode** **6** and the **RDS** **12** buttons simultaneously.

The unit will turn on automatically and display the **RESET** message in the **Main Information Display** **Y**. Note that once you have cleared the memory in this manner, it is necessary to re-establish all system configuration settings and tuner presets.

NOTE: Resetting the processor will erase any configuration settings you have made for speakers, output levels, surround modes, digital input assignments as well as the tuner presets. After a reset the unit will be returned to the factory presets, and all settings for these items must be reentered.

If the system is still operating incorrectly, there may have been an electronic discharge or severe AC line interference that has corrupted the memory or microprocessor.

If these steps do not solve the problem, consult an authorized Harman Kardon service depot.

Technical Specifications

Audio Section

Stereo Mode

Continuous Average Power (FTC)

80 Watts per channel, 20Hz–20kHz,
@ < 0.07% THD, both channels driven into 8 ohms

Five-Channel Surround Modes

Power Per Individual Channel

Front L&R channels:
70 Watts per channel,
@ < 0.07% THD, 20Hz–20kHz into 8 ohms

Center channel:
70 Watts, @ < 0.07% THD, 20Hz–20kHz into 8 ohms

Surround channels:
70 Watts per channel,
@ < 0.07% THD, 20Hz–20kHz into 8 ohms

Input Sensitivity/Impedance

Linear (High Level) 200mV/47kohms

Signal-to-Noise Ratio (IHF-A) 95dB

Surround System Adjacent Channel Separation

Analog Decoding 40dB
(Pro Logic, etc.)

Dolby Digital (AC-3) 55dB

DTS 55dB

Frequency Response

@ 1W (+0dB, -3dB) 10Hz–100kHz

High Instantaneous

Current Capability (HCC) ±45 Amps

Transient Intermodulation

Distortion (TIM) Unmeasurable

Rise Time 16 μsec

Slew Rate 40V/μsec**

FM Tuner Section

Frequency Range	87.5–108MHz
Usable Sensitivity	IHF 1.3 μV/13.2dB
Signal-to-Noise Ratio	Mono/Stereo: 70/65dB (DIN)
Distortion	Mono/Stereo: 0.15/0.3%
Stereo Separation	35dB @ 1kHz
Selectivity	±300kHz: 65dB
Image Rejection	80dB
IF Rejection	90dB

AM Tuner Section

Frequency Range	520–1611kHz
Signal-to-Noise Ratio	45 dB
Usable Sensitivity	Loop: 500μV
Distortion	1kHz, 50% Mod: 0.8%
Selectivity	±9kHz: 30dB

Video Section

Video Format	PAL/NTSC
Input Level/Impedance	1Vp-p/75 ohms
Output Level/Impedance	1Vp-p/75 ohms
Video Frequency Response	10Hz–8MHz (-3dB)

General

Power Requirement	AC 220-240V/50Hz
Power Consumption	78W idle, 694W maximum

Dimensions (Max)

Width	440mm
Height	167mm
Depth	435mm
Weight	15.9 kg

Depth measurement includes knobs, buttons and terminal connections.

Height measurement includes feet and chassis.

All features and specifications are subject to change without notice.

Harman Kardon is a registered trademark, and Power for the digital revolution is a trademark, of Harman International Industries, Inc.

|||EzSet is a trademark of Harman International Industries, Inc. (Patent No. 5,386,478).

*Manufactured under license from Dolby Laboratories.

"Dolby," "Pro Logic," "AC-3" and the Double-D symbol are trademarks of Dolby Laboratories. Confidential Unpublished Works. ©1992–1999 Dolby Laboratories, Inc. All rights reserved.

† DTS and DTS Surround are trademarks of Digital Theater Systems, Inc.

†† UltraStereo is a trademark of UltraStereo Corp.

VMAx is a trademark of Harman International Industries, Inc., and is an implementation of Cooper Bauck Transaural Stereo under patent license.

Logic 7 is a registered trademark of Lexicon, Inc.

Crystal is a registered trademark of Cirrus Logic Corp.

HDCD is a registered trademark of Pacific Microsonics, Inc.

**Without input anti slewing and output isolation networks.

harman/kardon

H A Harman International Company
250 Crossways Park Drive, Woodbury, New York 11797
www.harmankardon.com
Harman Consumer International:
2, route de Tours, 72500 Château-du-Loir, France
© 2000 Harman Kardon, Incorporated
Part No.: J90200012200

Free Manuals Download Website

<http://myh66.com>

<http://usermanuals.us>

<http://www.somanuals.com>

<http://www.4manuals.cc>

<http://www.manual-lib.com>

<http://www.404manual.com>

<http://www.luxmanual.com>

<http://aubethermostatmanual.com>

Golf course search by state

<http://golfingnear.com>

Email search by domain

<http://emailbydomain.com>

Auto manuals search

<http://auto.somanuals.com>

TV manuals search

<http://tv.somanuals.com>