

User's ▶▶▶▶▶ Manual

**Wired Network Camera
Wireless-G Network Camera**

HNC300/320G



Website: www.hawkingtech.com
E-Mail: techsupport@hawkingtech.com
Copyright © 2003 Hawking Technologies, Inc. All rights reserved.

Trademarks & Copyright

Windows 95/98/ME and Windows NT/2000/XP are registered trademarks of Microsoft Corp. All other brands and product names are trademarks of their respective companies.

No part of this publication may be reproduced in any form or by any means or used to make any derivative (such as translation, transformation or adaptation) without the express written consent of the manufacturer as stipulated by the United States Copyright Act of 1976.

FCC Certifications

This equipment has been tested and found to comply with the limits for a Class B digital device, pursuant to Part 15 of the FCC Rules. These limits are designed to provide reasonable protection against harmful interference in a residential installation. This equipment generates, uses and can radiate radio frequency energy and, if not installed and used in accordance with the instructions, may cause harmful interference to radio communications. However, there is no guarantee that interference will not occur in a particular installation. If this equipment does cause harmful interference to radio or television reception, which can be determined by turning the equipment off and on, the user is encouraged to try to correct the interference by one or more of the following measures:

- Reorient or relocate the receiving antenna.
- Increase the separation between the equipment and receiver.
- Connect the equipment into an outlet on a circuit different from that to which the receiver is connected.
- Consult the dealer or an experienced radio/TV technician for help.

Shielded interface cables must be used in order to comply with emission limits.

You are cautioned that changes or modifications not expressly approved by the party responsible for compliance could void your authority to operate the equipment.

This device complies with Part 15 of the FCC rules. Operation is subject to the following two conditions: (1) This device may not cause harmful interference, and (2) This device must accept any interference received, including interference that may cause undesired operation.

CE Mark Warning

This is a Class B product. In a domestic environment, this product may cause radio interference, in which case the user may be required to take adequate measures.

All trademarks and brand names are the property of their respective proprietors.

Specifications are subject to change without prior notification.

HAWKING LIMITED WARRANTY

Hawking Technology guarantees that every HNC300 Network Camera and every HNC320G Wireless-G Network Camera is free from physical defects in material and workmanship under normal use for (1) year from the date of purchase. If the product proves defective during this one-year warranty period, call Hawking Customer Service in order to obtain a Return Authorization number. Warranty is for repair or replacement only. Hawking Technology does not issue any refunds. **BE SURE TO HAVE YOUR PROOF OF PURCHASE. RETURN REQUESTS CANNOT BE PROCESSED WITHOUT PROOF OF PURCHASE.** When returning a product, mark the Return Authorization number clearly on the outside of the package and include your original proof of purchase.

IN NO EVENT SHALL HAWKING TECHNOLOGY'S LIABILITY EXCEED THE PRICE PAID FOR THE PRODUCT FROM DIRECT, INDIRECT, SPECIAL, INCIDENTAL OR CONSEQUENTIAL DAMAGES RESULTING FROM THE USE OF THE PRODUCT, ITS ACCOMPANYING SOFTWARE OR ITS DOCUMENTATION. Hawking Technology makes no warranty or representation, expressed, implied or statutory, with respect to its products or the contents or use of this documentation and all accompanying software, and specifically disclaims its quality, performance, merchantability, or fitness for any particular purpose. Hawking Technology reserves the right to revise or update its products, software, or documentation without obligation to notify any individual or entity. Please direct all inquiries to: techsupport@hawkingtech.com.



Table of Contents

HNC300 Network Camera & HNC320G Wireless-G Network Camera

About This User's Manual	6
Introduction	7
System Requirements	8
Features and Benefits	9
Physical Description	10
<u>HNC300</u>	
Front Panel	10
<i>Power LED</i>	10
<i>Link LED</i>	10
Rear Panel	11
<i>Network Cable Connector</i>	11
<i>DC Power Connector</i>	11
<i>Reset Button</i>	11
Top Panel	12
<i>Screw Hole</i>	12
Bottom Panel	12
<i>Screw Hole</i>	12
<u>HNC320G</u>	
Front Panel	13
<i>Power LED</i>	13
<i>Link LED</i>	13
Rear Panel	14
<i>Network Cable Connector</i>	14
<i>DC Power Connector</i>	14
<i>Reset Button</i>	14
<i>Antenna Connector</i>	14
Top Panel	15
<i>Screw Hole</i>	15
Bottom Panel	15
Screw Hole	15
Unpacking the Camera	16
Hardware Installation	17
<u>HNC300</u>	
Connect an Ethernet Cable	17
Attach the External Power Supply	17
<u>HNC320G</u>	
Attach Wireless Antenna	18
Connect an Ethernet Cable	18
Attach the External Power Adapter	19
Security	20
Web Configuration	21
Web Configuration	21
Main Menu Page	21



Table of Contents

HNC300 Network Camera & HNC320G Wireless-G Network Camera

System Administration	22
HNC300	22
HNC320G	22
<u>HNC300</u>	
System Administration: <i>Management</i>	22
System Administration: <i>Configuration</i>	25
System Administration: <i>Tools</i>	35
System Administration: <i>Help</i>	38
<u>HNC320G</u>	
System Administration: <i>Management</i>	39
System Administration: <i>Configuration</i>	42
System Administration: <i>Tools</i>	55
System Administration: <i>Help</i>	58
View Image – ActiveX Mode	59
View Image – Java Mode	60
Camera Applications	
Applications	61
Home Applications	61
SOHO (Small Office, Home Office) Applications	62
IPView SE Application Installation	63
IPView SE – Getting Started	68
IPView SE Control Panel	68
How to Add Camera	69
How to Change Cameras	72
How to Connect/Disconnect the Image	73
How to Delete a Camera	74
Extra Information	75
How to Adjust the Property Setting	75
Motion Setting	77
Update Firmware	78
How to Adjust the Recording Settings	79
Appendix	
A. Frequently Asked Questions	80
B. Ping Your IP Address	81
C. Troubleshooting	81
D. Upgrade Firmware	83
E. Time Zone Table	84
F. Xplug Control Installation	85
G. Adjusting the Camera Focus	88
H. Specifications: HNC300	89
HNC320G	91
I. How to View Your Camera via the Internet	93
J. Glossary of Terms	98



About This User's Manual

HNC300 Network Camera & HNC320G Wireless-G Network Camera

This user's manual gives a full explanation of the HNC300 (*Wired*) Network Camera and HNC320G Wireless-G Network Camera, including a description of features, installation procedures, web configuration, and other functions. Also included in the user's manual are the operating procedures for the IPView SE application.



Introduction

HNC300 Network Camera & HNC320G Wireless-G Network Camera

Thank you for purchasing either the HNC300 Network Camera or the HNC320G Wireless-G Network Camera. The HNC300 connects directly to an Ethernet or Fast Ethernet network. The HNC320G can also connect directly to an Ethernet or Fast Ethernet network, but also supports the IEEE 802.11b/g wireless standard. The HNC300 Series (the collective title for the HNC300 & HNC320G models) network cameras are different from conventional PC cameras in that they are standalone systems with built-in CPUs and web servers. Therefore, they connect directly to the local area network (LAN) and do not need to be connected to a designated PC. Thus, they provide a low cost solution that can transmit high quality video images for monitoring and surveillance. The network cameras can be managed remotely, and can be accessed and controlled from any PC/Notebook over the LAN or Internet using only a web browser. The simple installation procedures and web-based interface offer easy integration to your network application environments.



System Requirements

HNC300 Network Camera & HNC320G Wireless-G Network Camera

HNC300 & HNC320G

Network:

Local Area Network (*HNC300 & HNC320G*): 10Base-T Ethernet or 100Base TX Fast Ethernet

Wireless Local Area Network (*HNC320G*): IEEE 802.11b/g Wireless LAN

Recommended PC or Notebook to Access the HNC300 & HNC320G:

For Web Browser Users

- Operating System: Microsoft Windows 98SE/ME/2000/XP
- CPU: Pentium II, 266 MHz or above
- Memory Size: 32 MB (64 MB recommended)
- VGA card resolution: 800x600 or above
- Internet Explorer 5.0 or above (ActiveX & JAVA Mode – Image View for Windows OS and JAVA Mode – Image View for other OS)
- Netscape 6.0 or above (JAVA Mode – Image View)

IPView SE Application:

- Supported Operating Systems: Win 98 SE, Win 2000, Win Me, Win XP
- System requirements for IPView SE:
 - CPU: Pentium III, 450 MHz or above
 - Memory Size: 128 MB (256 MB recommended)
 - VGA card resolution: 800x600 or above



Features and Benefits

HNC300 Network Camera & HNC320G Wireless-G Network Camera

This section describes the features and benefits of the HNC300 Network Camera & HNC320G Wireless-G Network Camera.

Simple to Use

The HNC300 and HNC320G are standalone systems with built-in CPUs, and thus, require no special hardware or software such as PC frame grabber cards. The HNC300 and HNC320G support both ActiveX mode for Internet Explorer and Java mode for Internet Explorer and Netscape Navigator. Therefore, all that is required is web browser software such as Internet Explorer 5.0 or above, or Netscape 6.0 or above. All you need is a valid IP address to view the picture from your network camera.

Supports a Variety of Platforms

The HNC300 & HNC320G both support TCP/IP networking, SMTP e-mail, HTTP and other Internet related protocols. Both models can be utilized in mixed operating system environments such as Windows, Unix, and Mac. They can easily be integrated into other Internet/Intranet applications.

Web Configuration

Using a standard web browser, the administrator can configure and manage the HNC300 or HNC320G directly from its own web page via the web.

HNC300

The administrator can set up to 8 usernames and passwords via the privilege settings.

HNC320G

The administrator can set up to 64 usernames and passwords via the privilege settings.

Remote Utility

The powerful IPView SE application assigns the administrator a pre-defined user ID and password through which, he/she can modify the HNC300/HNC320G settings from a remote site via the Intranet or Internet. For added convenience, when new firmware becomes available, the administrator can also upgrade remotely over the network. Users are also allowed to monitor the images and take snapshots.

Broad Range of Applications

Using today's high-speed Internet services, the HNC300 and HNC320G network cameras can provide an ideal high performance, cost-effective solution that delivers live video images over the Intranet and Internet for remote monitoring and surveillance. The network cameras allow remote access from a web browser for live image viewing. They also allow administrators to manage and control the network cameras anytime from anywhere in the world. You can set up the network cameras to monitor various objects and locations such as homes, offices, banks, hospitals, child-care centers, amusement parks and a variety of other industrial and public areas. The network cameras can also be used for intruder detection, still image capture for archiving, and many other applications.



Physical Description

HNC300 Network Camera & HNC320G Wireless-G Network Camera

HNC300

This section describes the externally visible features of the HNC300.

Front Panel

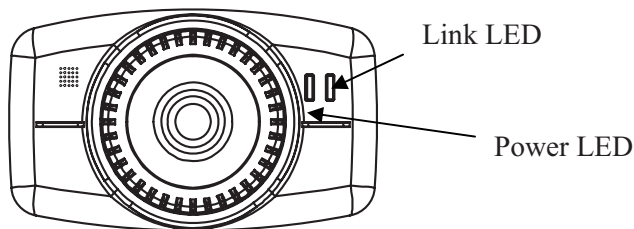

Power LED

The “Power” LED is located to the right of the camera’s lens (when facing the camera). A steady blue light confirms that the camera is powered on.

Note:

The “Power” LED has three settings with which to control the light illumination while monitoring: Normal / Off / Dummy. Please refer to the “Web Configuration” section for detailed information and usage.

Link LED

The “Link” LED is located on the far right side of the network camera’s lens (when facing the network camera). It is located to the right of the “Power” LED. A steady orange light confirms a good connection. Depending on the data traffic, the LED will begin to flash to indicate that the camera is receiving/transmitting from/to the network.

Note:

The “Link” LED has three settings with which to control the light illumination while monitoring: Normal / Off / Dummy. Please refer to the “Web Configuration” section for detailed information and usage.



Physical Description

HNC300 Network Camera & HNC320G Wireless-G Network Camera

Rear Panel

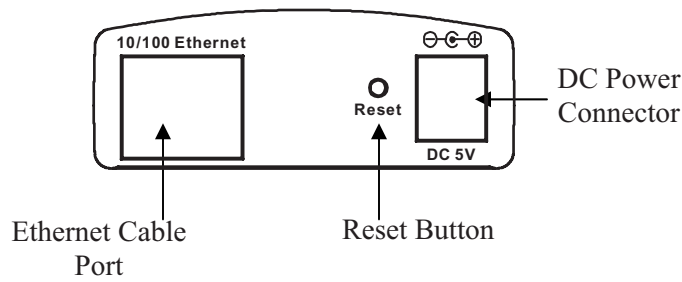

Network Cable Connector

The rear panel of the network camera features an RJ-45 connector for 10Base-T Ethernet or 100Base-TX Fast Ethernet connections (using Category 5 twisted-pair cabling). The port supports the N-Way protocol and the “Auto-MDIX” function, thereby allowing the network camera to automatically detect or negotiate the transmission speed of the network.

DC Power Connector

The DC power input connector is located on the rear panel of the network camera and is labeled DC 5V with a single jack socket to supply power to the camera. Power will be generated when the power supply is connected to a wall outlet.

Reset Button

Reset will be initiated when the reset button is pressed once and the “Power” LED begins to flash.

Factory Reset will be initiated when the reset button is pressed continuously for at least three seconds or when the “Power LED” begins to light up. Release the reset button and the “Power” LED will begin to flash, indicating that the network camera is utilizing the factory reset. When factory reset is completed, the IP address will return to the **default setting** of **192.168.0.20**.



Physical Description

HNC300 Network Camera & HNC320G Wireless-G Network Camera

Top Panel

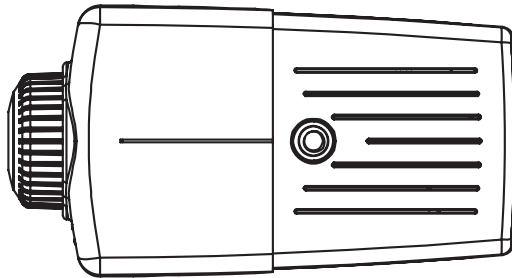

Screw Hole

Located on the top panel of the network camera, the screw hole is used to connect the camera stand onto the camera by attaching the screw head on the camera stand into the screw hole of the camera.

Bottom Panel

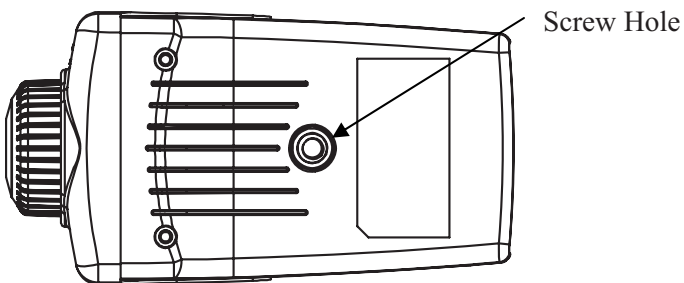

Screw Hole

Located on the bottom panel of the network camera, the screw hole is used to connect the camera stand onto the camera by attaching the screw head on the camera stand into the screw hole of the camera.



Physical Description

HNC300 Network Camera & HNC320G Wireless-G Network Camera

HNC320G

This section describes the externally visible features of the HNC320G.

Front Panel

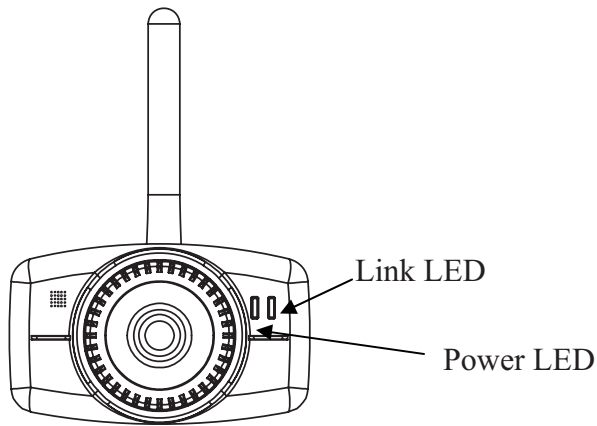

Power LED

The “Power” LED is located to the right of the camera’s lens (when facing the camera). A steady blue light confirms that the camera is powered on.

Note:

The “Power” LED has three settings with which to control the light illumination while monitoring: Normal / Off / Dummy. Please refer to the “Web Configuration” section for detailed information and usage.

Link LED

The “Link” LED is located on the far right side of the network camera’s lens (when facing the wireless network camera). It is located to the right of the “Power” LED. A steady orange light confirms a good connection. Depending on the data traffic, the LED will begin to flash to indicate that the camera is receiving/transmitting from/to the network.

Note:

The “Link” LED has three settings with which to control the light illumination while monitoring: Normal / Off / Dummy. Please refer to the “Web Configuration” section for detailed information and usage.



Physical Description

HNC300 Network Camera & HNC320G Wireless-G Network Camera

Rear Panel

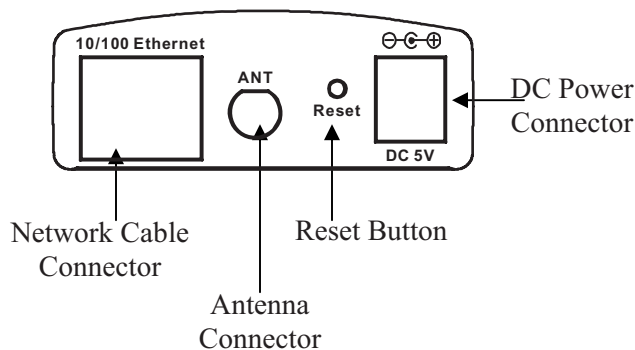

Network Cable Connector

The rear panel of the wireless network camera features an RJ-45 connector for 10Base-T Ethernet or 100Base-TX Fast Ethernet connections (using Category 5 twisted-pair cabling). The port supports the N-Way protocol and the “Auto-MDIX” function, thereby allowing the wireless network camera to automatically detect or negotiate the transmission speed of the network.

DC Power Connector

The DC power input connector is located on the rear panel of the wireless network camera and is labeled DC 5V with a single jack socket to supply power to the camera. Power will be generated when the power supply is connected to a wall outlet.

Reset Button

Reset will be initiated when the reset button is pressed once and the “Power” LED begins to flash.

Factory Reset will be initiated when the reset button is pressed continuously for at least three seconds or when the “Power” LED begins to light up. Release the reset button and the “Power” LED will begin to flash, indicating that the wireless network camera is utilizing the factory reset. When factory reset is completed the wireless camera will be set to **Channel 11** by default and the ESS-ID is set as “**NULL String**”. (This default setting will let the wireless camera connect to ANY access point on the infrastructure network). The IP address will also return to the **default setting** of **192.168.0.20**.

Antenna Connector

The SMA-type antenna connector is located on the rear panel of the wireless camera, thereby providing connection for a high-sensitivity antenna that is included with the device. The antenna can rotate, thus allowing the user to adjust its position to obtain the best signal.



Physical Description

HNC300 Network Camera & HNC320G Wireless-G Network Camera

Top Panel

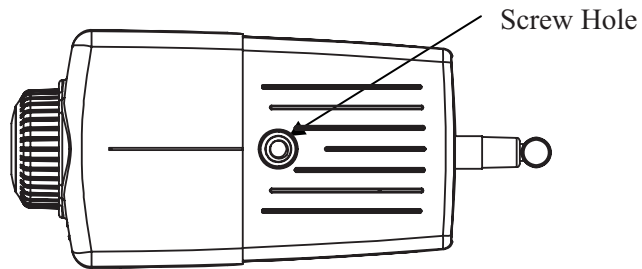

Screw Hole

Located on the top panel of the wireless camera, the screw hole is used to connect the camera stand onto the camera by attaching the screw head on the camera stand into the screw hole of the wireless camera.

Bottom Panel

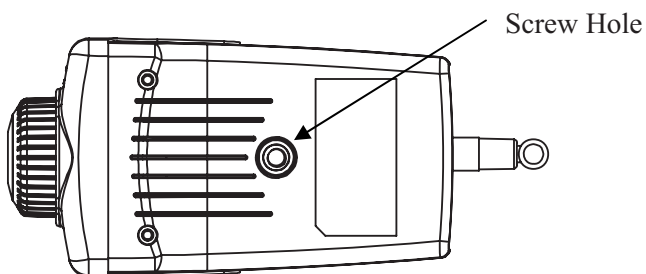

Screw Hole

Located on the bottom panel of the wireless camera, the screw hole is used to connect the camera stand onto the camera by attaching the screw head on the camera stand into the screw hole of the wireless camera.



Unpacking the Camera

HNC300 Network Camera & HNC320G Wireless-G Network Camera

Unpack and Inspect

Open the package and carefully remove all items.

The complete **HNC300** package consists of:

- One HNC300 (*Wired*) Network Camera
- One Installation CD-ROM
- One Quick Installation Guide
- One DC power adapter
- One Camera Stand
- One RJ-45 Ethernet Cable
- One Hosted Video Management Datasheet

The complete **HNC320G** package consists of:

- One HNC320G Wireless Network Camera
- One External Wireless Antenna
- One Installation CD-ROM
- One Quick Installation Guide
- One DC power adapter
- One Camera Stand
- One RJ-45 Ethernet Cable
- One Hosted Video Management Datasheet

Please check to make sure that the unit was not damaged during shipping and that no items are missing. If you encounter a problem, please contact your dealer.

Please read this manual thoroughly, and follow the installation and operation procedures contained within.

Connecting the HNC300/HNC320G to the Camera Stand

The HNC300 and HNC320G packages include a camera stand (installation is optional) with a swivel ball screw head that can be attached to the camera's screw holes. Attach the camera stand to the camera and orient it in the most appropriate position for your specific application. In addition, there are three holes located on the base of the camera stand, thereby allowing the camera to be securely mounted on the ceiling or wall.

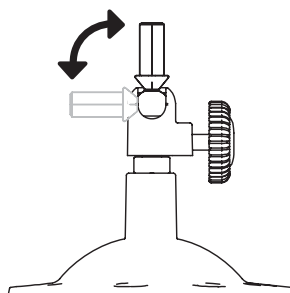



Hardware Installation

HNC300 Network Camera & HNC320G Wireless-G Network Camera

This section describes the hardware installation procedures for the HNC300 and HNC320G.

HNC300

Connect an Ethernet Cable

Connect an Ethernet cable to the Ethernet cable port located on the rear panel of the camera, and attach the other end to the network.

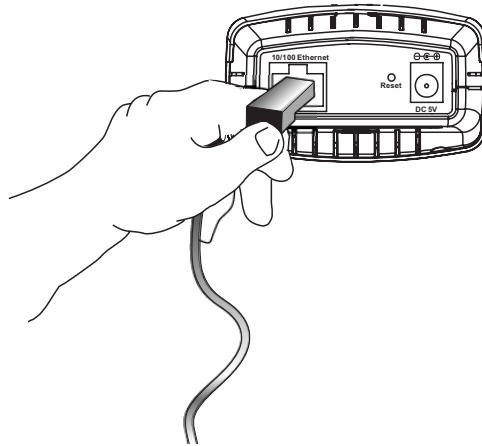

Attach the External Power Supply

Attach the external power supply to the DC power input connector located on the rear panel of the camera. The input connector is labeled “DC 5V”. Connect it to your local power supply.

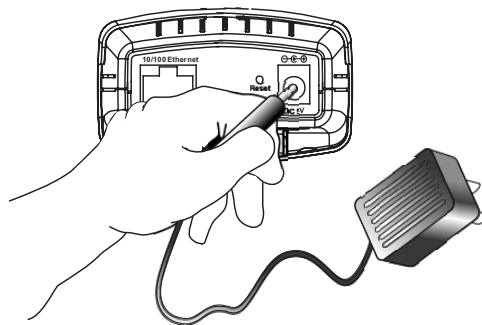

Note:

Confirm that the device is receiving power by making sure that the “Power” LED is illuminated.



Hardware Installation

HNC300 Network Camera & HNC320G Wireless-G Network Camera

HNC320G

Attach Wireless Antenna

On the rear panel of the wireless camera, screw into the antenna connector the single external antenna that was included in the product packaging.

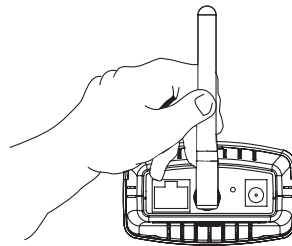

Connect an Ethernet Cable

Connect an Ethernet cable to the Ethernet cable port located on the rear panel of the camera, and attach the other end to the network.

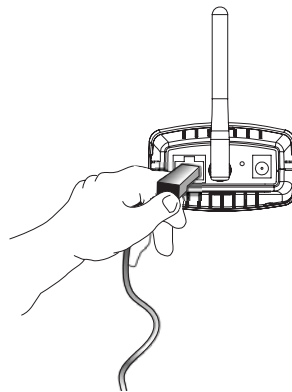



Hardware Installation

HNC300 Network Camera & HNC320G Wireless-G Network Camera

Attach the External Power Supply

Attach the external power supply to the DC power input connector located on the rear panel of the camera. The input connector is labeled “DC 5V”. Connect it to your local power supply.

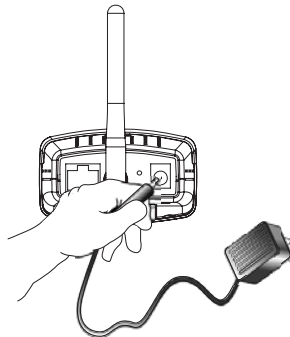

Note:

Confirm that the device is receiving power by making sure that the “Power” LED is illuminated.

Please Note: Once you have configured your HNC320G camera so that it is connected to your existing wireless network (i.e. you have configured it with all the correct wireless settings), you can then remove the Ethernet cable.



HNC300 Network Camera & HNC320G Wireless-G Network Camera

To ensure the highest security and prevent unauthorized usage of the HNC300 or HNC320G, the network administrator has an exclusive privilege to access the cameras' System Administration to change settings and control requirements that allow entry and authorized privileges for all users. The HNC300 and HNC320G support multi-level password protection. Access to the cameras is restricted to defined users only, who have a "User Name" and "User Password" that has been assigned by the administrator.

Administrators can release a public user name and password so that when remote users access the HNC300 or HNC320G, they will have access to view the images transmitted by the cameras.

Note:

When the HNC300 or HNC320G is used for the first time, it is highly recommended that the administrator set the "Admin ID" and "Admin Password" to restrict users' access to the cameras since the Default settings are the Null String (i.e., the default Admin ID and Admin Password are **blank**). Once the ID and Password are defined, only the administrator has access to manage the cameras. This operation should be performed as soon as possible since the security features of the HNC300 and HNC320G will not be enabled until the "Admin ID" and "Admin Password" are defined.



Web Configuration

HNC300 Network Camera & HNC320G Wireless-G Network Camera

This section describes the web configuration procedures for the HNC300 and HNC320G.

Web Configuration

The HNC300 and HNC320G must be configured via their built-in Web-based Configuration. Knowledge of local area networks (LANs) will be useful when setting up the cameras.

In the web browser, enter the default IP address to access the Welcome screen of the network camera. From here you can configure your network camera. For the default IP address, type “http://192.168.0.20” in the address box. (If you have already used the Setup Wizard to change the camera’s IP address, then enter the new IP address in the web address bar.) The numbered portion of the address is the IP address of your camera.

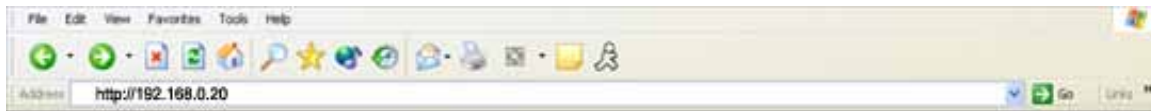

Note:

The first three segments of the PC’s IP address must correspond with the first three segments of the camera’s IP address in order for them to communicate. The PC and network camera must have the same “Subnet” and “Default Gateway”.

Main Menu Page

Once the IP address is entered in the web address bar, the screen shown below will appear with a still image. There will be three options to choose from to set up and view your network camera. They are as follows:

- View Image – ActiveX Mode
- View Image – Java Mode
- System Administration





Web Configuration

HNC300 Network Camera & HNC320G Wireless-G Network Camera

System Administration

Click on “System Administration” on the “Welcome” screen to access the settings for the network camera. There will be several options to choose from in the menu bar. They are listed below for both, the HNC300 and HNC320G.

HNC300

1. Management
2. Configuration
3. Tools
4. Help
5. Home

HNC320G

- Management
- Configuration
- Tools
- Help
- Home

HNC300

System Administration: Management

The Management window contains the information you will need to configure your camera. Click the items in the menu bar to the right of the text “Internet Camera” to view your settings, including: **System**, **Video**, **Network**, and **User**.

HAWKING TECHNOLOGY
Management | Configuration | Tools | Help | Home

Internet Camera

System | Video | Network | User

System

Device Status

Camera Name	: Hawking NetCam
Location	: Warehouse
Model	: HNC320G
Firmware Version	: 3.xx (2005-09-30)
MAC Address	: 00 FF 11 11 66 00
IP Address	: 192.168.0.20

Ethernet Status

Link	: Yes
Speed	: 100Mbps
Duplex	: Full Duplex



Web Configuration

HNC300 Network Camera & HNC320G Wireless-G Network Camera

System

Click **System** to the right of the text “Internet Camera” to display the device status of your camera.

Device Status	
Camera Name	: Hawking NetCam
Location	: Warehouse
Model	: HNC320G
Firmware Version	: 3.xx (2005-09-30)
MAC Address	: 00 FF 11 11 66 00
IP Address	: 192.168.0.20
Ethernet Status	
Link	: Yes
Speed	: 100Mbps
Duplex	: Full Duplex
<input type="button" value="Refresh"/>	

- **Device Status:** The camera’s vital information, including the Camera Name, Location, Model, Firmware Version, MAC Address and IP Address, can be found in this field.
- **Ethernet Status:** You can monitor the camera’s network status in this field, including Link (network connection), Speed, and the Duplex mode.

Video

Click **Video** to the right of the text “Internet Camera” to display your camera’s video configuration information.

Video	
Video Status	
Video Resolution	: 320 x 240
Compression Rate	: Medium
Frame Rate	: Auto
Frame Size	: 7904 Bytes
Light Frequency	: 60 Hz
<input type="button" value="Refresh"/>	

- **Video Status:** The camera’s video configuration information, including the Video Resolution, Compression Rate, Frame Rate, Frame Size and IP Address, can be found in this field.



Web Configuration

HNC300 Network Camera & HNC320G Wireless-G Network Camera

Network

Click **Network** to the right of the text “Internet Camera” to display the camera’s network status information.

Network	
Network Status	
IP Address	: 192.168.0.20
Subnet Mask	: 255.255.255.0
Default Gateway	: 0.0.0.0
Primary DNS Address	: 0.0.0.0
Secondary DNS Address	: 0.0.0.0
Dynamic DNS	: Disabled
Secondary HTTP Port	: Disabled (Port: 81)
UPnP	: Enabled (IP: 0.0.0.0)
FTP Server Test	:
E-mail Test	:

- **Network Status:** The items in this field display the camera’s network status information, such as the IP Address, Subnet Mask, Default Gateway, Primary DNS Address, Secondary DNS Address, Dynamic DNS, Secondary HTTP Port, and UPnP.

User

Click **User** to the right of the text “Internet Camera” to display the user(s) information.

User			
Active Users			
IP Address	Name	DateTime	Miniseconds / Packet

- **Active Users:** The items in this field display the user information, including the user IP address, Name, and Date & Time.



Web Configuration

HNC300 Network Camera & HNC320G Wireless-G Network Camera

System Administration: Configuration

The **Configuration** window contains commands for settings that are required for inputting key details to set up the camera for operation. Click **Configuration** in the top menu bar and the Configuration window will appear as below:



System

Click on **System** to the right of the text “Internet Camera” to adjust your camera’s basic configuration settings.

System	
System Setting	
Camera Name :	<input type="text" value="Hawking NetCam"/>
Location :	<input type="text" value="Warehouse"/>
Admin :	Admin ID : <input type="text" value="hawkingntcam"/>
	Admin Password : <input type="password" value="*****"/>
	Confirm Again : <input type="password" value="*****"/>
LED Control :	<input checked="" type="radio"/> Normal <input type="radio"/> OFF <input type="radio"/> Dummy
<input type="button" value="Save"/> <input type="button" value="Cancel"/>	

System Setting: In this field, you can configure your camera’s basic settings.



Web Configuration

HNC300 Network Camera & HNC320G Wireless-G Network Camera

- **Camera Name:** This field is used to enter a descriptive name for the device. The default setting for the Camera Name is **CS-xxxxxx**, where “xxxxxx” constitutes the last six digits of the device’s MAC Address. The maximum length is 32 characters (printable ASCII).
- **Location:** This field is used to enter a descriptive name for the camera’s location.
- **Admin:** The fields in this section are used to enter the administrator’s name (“Admin ID”) and password. The administrator’s ID and password will allow the user to access and configure the System Administration settings. Be sure to enter the password twice to confirm the details, once in the **Admin Password** field and again in the **Confirm Password** field.

The default settings for both the administrator user name and password are **blank** (or null string). The administrator name (“Admin ID”) has a maximum length of 12 (printable ASCII) characters and the administrator password has a maximum length of 8 (printable ASCII) characters.

It is highly recommended that you set the Admin ID and Admin Password as soon as possible to enable security options for the camera.

NOTE: If you would like to create a user account that only has access to the video image, but not the system administration settings, you can do this in the “User” page of the Configuration section. Instructions on how to create such a user are provided in the pages that follow.

- **LED Control:** This option allows users to set up the LEDs, as desired. This feature provides flexibility when surveillance activity is ON.

There are three options, and they are as follows:

Normal	Power - Steady On Link - Steady On Note: When there is LAN activity, the LED indicator will flash steadily.
OFF	Power - LED indicator is off. Link - LED indicator is off.
Dummy	Power - Steady On Link - Steady On, with random flashing.

The default setting for the LED control is **Normal**. When you have configured the LED controls, the correct illumination will set after 1 minute.



Web Configuration

HNC300 Network Camera & HNC320G Wireless-G Network Camera

Video

Click **Video** to the right of the text “Internet Camera” to configure the camera’s video settings.

Video

Video Setting

Video Resolution : 160 x 120 320 x 240 640 x 480

Compression Rate : Very Low Low Medium High Very High

Frame Rate : 1 5 7 15 20 Auto (Frames/Sec.)

Brightness Control :

Contrast Control :

Saturation Control :

Light Frequency : 50 Hz 60 Hz

Mirror : Horizontal Mirror Vertical Mirror

Anti-Flicker :

Video Setting: In this field, you can configure the camera’s basic video settings.

- **Video Resolution:** Select the desired video resolution format: **160 x 120**, **320 x 240** (default), or **640 x 480**.
- **Compression Rate:** Select the desired compression rate. You will have five levels to choose from, ranging from **Very Low** to **Very High**. A higher video compression rate will generate a more compact file size with poorer video quality, and vice-versa. The default setting is **Medium**.
- **Frame Rate:** Select the desired frame rate. The default setting is **Auto** for an optimal frame rate.
- **Brightness Control:** Adjust the brightness level; the default setting is **64**.
- **Contrast Control:** Adjust the contrast level; the default setting is **64**.
- **Saturation Control:** Adjust the saturation level; the default setting is **64**.
- **Light Frequency:** Adjust the light frequency to suit your area of operation. The options are: **50 Hz** or **60 Hz** (60Hz is the default).
- **Mirror:** Select **Horizontal Mirror** to flip the image horizontally, or **Vertical Mirror** to flip the image vertically.
- **Anti-Flicker:** If you capture a flickering image because of the environment factor (for example, from the intense light from a lamp), please select this item to solve the problem.



Web Configuration

HNC300 Network Camera & HNC320G Wireless-G Network Camera

Network

Click on **Network** to the right of the text “Internet Camera” to configure the LAN settings for your camera.

The screenshot shows the 'Network' configuration page with the 'TCP/IP' tab selected. The 'IP Address Mode' is set to 'Fixed IP'. The 'IP Address' field contains '192.168.0.20', the 'Subnet Mask' is '255.255.255.0', and the 'Default Gateway' is '0.0.0.0'. The 'Dynamic IP (DHCP)' and 'PPPoE' options are unselected. The 'DNS IP Address' section has two entries, both set to '0.0.0.0'. The 'Dynamic DNS' section is set to 'Disable', with a 'Service Provider' dropdown menu. The 'Host Name', 'User Name/E-mail', and 'Password/Key' fields are empty. The 'Second HTTP Port' section is set to 'Disable', with an empty 'Port Number' field. The 'UPnP' section is set to 'Disable'. At the bottom, there are 'Save' and 'Cancel' buttons.

TCP/IP:

- **IP Address Mode:** This field provides you with three options. They are as follows:
 - Fixed IP** – You can select this option and enter the IP address directly. The default settings are:
 - IP Address – 192.168.0.20
 - Subnet Mask – 255.255.255.0
 - Default Gateway – 0.0.0.0

Dynamic Address (DHCP) – If your network uses a DHCP server, you may select this option. According to this setting, the camera will automatically be assigned an IP address from the DHCP server. Once you click “Save” at the bottom of the page, wait for the camera to reboot (this could take up to one minute). After the camera has finished rebooting, you can locate the camera’s new IP address via the camera’s Setup Wizard utility. The new IP address should appear under the “Current IP Address” heading in the utility. (If you have multiple cameras on the network, you may need to test the newly assigned IP addresses to locate the camera you have just configured.)

PLEASE NOTE: If you want to be certain of your camera’s IP address at all times, “Fixed IP” is the preferred option.



Web Configuration

HNC300 Network Camera & HNC320G Wireless-G Network Camera

PPPoE – If your application requires a direct connection from an ADSL modem through the camera’s RJ-45 LAN port, click this option and enter the User ID and Password into the respective boxes. (*You should have an ISP PPPoE account.*) The camera will get an IP address from the ISP when it starts up.

- **DNS IP Address:** A DNS (Domain Name System) server is an Internet service that translates domain names into IP addresses. Enter at least one DNS IP Address in this field.
- **Dynamic DNS:** The Dynamic DNS service allows you to alias a dynamic IP address to a static hostname in any of the domains, allowing your computer to be accessed more easily from various locations on the Internet.
- **Second HTTP Port:** The default port for communication is via port 80, and you can change it according to your network configuration. Select **Enable** from the option and enter the desired port number in the appropriate box.

The **Second HTTP Port** field allows you to open a second port for the network camera. This will permit users’ routers to support *multiple* network cameras. By default, Port 80 (on the router) is always open for network camera web server access.

For example, assume you have five network cameras to be installed, with the following IP addresses:

192.168.0.101
192.168.0.102
192.168.0.103
192.168.0.104
192.168.0.105

You can open the second port for each network camera, from port 81 to Port 85, as illustrated below:

Internet Camera 1 – IP 192.168.0.101, second web port 81
Internet Camera 2 – IP 192.168.0.102, second web port 82
Internet Camera 3 – IP 192.168.0.103, second web port 83
Internet Camera 4 – IP 192.168.0.104, second web port 84
Internet Camera 5 – IP 192.168.0.105, second web port 85

You also need to setup your router for Port Mapping.

Port 81 map to 192.168.0.101
Port 82 map to 192.168.0.102
Port 83 map to 192.168.0.103
Port 84 map to 192.168.0.104
Port 85 map to 192.168.0.105

Save/Cancel:

After making sure that all settings in the System are correct, click on the **“Save”** button to store the settings for the network camera. You can alternatively click on the **“Cancel”** button to restore all settings to the values last saved to or retrieved from the network camera.

- **UPnP:** UPnP is the architecture for pervasive peer-to-peer network connectivity of intelligent appliances and PCs of all form factors. Check the **Enable** option to enable the function on your camera.



Web Configuration

HNC300 Network Camera & HNC320G Wireless-G Network Camera

User

Click on **User** to the right of the text “Internet Camera” to add, edit and delete users for your camera.

User

User Access Control

Access Control : Enable Disable

Define Users

Add User : User Name :

User Password :

Upload/E-mail Video : Yes No

Delete User :

User List : UserTable

Name	Upload/E-mail Video
------	---------------------

User Access Control:

- **Access Control:** The administrator has the authority to give specific users permission to control the device and make configuration changes by selecting **Enable** or **Disable**. The default setting is **Disable**. When the “Access Control” setting is set to “Disable” for a specific user, that user will only be able to view the image, and will not be able to make any configuration changes to the device.

Define Users: Use this field to add or delete users for your camera.

- **Add User:** Enter the user name in this box, and enter the password that was assigned by the administrator for this user. The maximum password length is 8 (printable ASCII) characters. The administrator has the authority to give specific users permission to control the **Upload/E-mail Video** control by selecting **Yes** or **No** to activate the **Upload/E-mail Video**. To add a new user’s name, enter the necessary information first and click the **Add** button.
- **Delete User:** Select the user you want to delete from the pull-down menu, and then click the **Delete** button.
- **User List:** This list displays the camera’s current user status.



DateTime

Click on **DateTime** to right of the text “Internet Camera” to set up the time and date for your camera.

Date & Time Setting

Date & Time : Synchronized with Time Server

IP Address :

Protocol : NTP Time

TimeZone :

Set Manually

Date : (Example : 2004-09-01)

Time : (Example : 06:12:35)

Synchronized with Computer Time

Date & Time: You can set up the time and date automatically by selecting the *Synchronized with Time Server* option, or manually in the *Set Manually* section.

- **Synchronized with Time Server:** Select this option to set the time according to the GMT setting. The time will be synchronized every 10 minutes. When selecting this option, you have to enter the required information in the following fields:
 - IP Address** – Enter the IP Address of the Time Server in this box.
 - Protocol** – You can select from two options, *NTP* or *Time*, to link with the Time Server. The default setting is *NTP*.
 - TimeZone** – Select the time zone for the region from the pull-down menu.
- **Set Manually:** Select this option to set the time manually. The system administrator must manually enter the date and time in the respective field.



Web Configuration

HNC300 Network Camera & HNC320G Wireless-G Network Camera

Upload

Click on **Upload** to the right of the text “Internet Camera” to set up the configuration for the FTP server, time schedule, and manual operation.

Upload

FTP Server

Host Address :

Port Number : (Default is 21)

User Name :

Password :

Directory Path :

Passive Mode : Yes No

Time Schedule

Time : Enable upload video to FTP server

Schedule

Always

Schedule

Day : Mon Tue Wed Thu Fri Sat Sun

Time : Start: (Example : 06:30:00)

Period : Stop: (Example : 22:30:00)

Video Frequency: Frames/Second

Seconds/Frame

Base File Name :

File : Overwrite

Date/Time Suffix

Sequence Number Suffix Up to

Manual Operation

Manual : Enable upload video to FTP server

Operation

Base File Name :

File : Overwrite

Date/Time Suffix

Sequence Number Suffix Up to

FTP Server: This field contains the following six basic settings for your FTP server.

- **Host Address:** The IP Address of the target FTP server.
- **Port Number:** The standard port number for the FTP server is Port **21**, which is also the default setting. If the FTP server uses a different port, please confirm this with the IT manager.
- **User Name:** Enter the user name in this field.
- **Password:** Enter the user password in this field to login into the FTP server.
- **Directory Path:** Enter an existing folder name in this field, and the images will be uploaded to the given folder.
- **Passive Mode:** This function depends on your FTP server. Please check with your IT manager if the FTP server uses passive mode. The default setting is **No**.



Web Configuration

HNC300 Network Camera & HNC320G Wireless-G Network Camera

Time Schedule: Select the “*Enable upload video to FTP server*” option and enter the relevant information, such as the schedule, video frequency and base file name.

- **Schedule:** You can 1.) Choose *Always* to always upload the video to the FTP server, or 2.) Set a *Schedule* to manage the uploading task. In the Schedule option, you can set the *Day* and *Time Period* options.
- **Video Frequency:** There are two ways to set the video frequency: 1.) Set *Auto/1/2/3* frames per second, or 2.) Set the time, in seconds, for every frame.
- **Base File Name:** Enter the file name to make sure that the images are saved using this base file name.
- **File:** Since it is likely that you will upload more than one image to the FTP server, you can choose the filing rule, including *Overwrite*, *Date/Time Suffix*, and set up the *Sequence Number*.

Manual Operation: When you click the *Upload Video* button in the video viewing screen, it will start to upload the image. The settings refer to the *Base File Name* and *File* information above.



Web Configuration

HNC300 Network Camera & HNC320G Wireless-G Network Camera

Email

Click on **E-mail** to the right of the text “Internet Camera” to configure the E-mail account, time schedule and manual operation settings.

E-mail

E-mail Account

SMTP Server Address :

Sender e-mail Address :

Receiver e-mail Address :

User Name :

Password :

Time Schedule

Time : Enable e-mail video to e-mail account

Schedule

Always

Schedule

Day : Mon Tue Wed Thu Fri Sat Sun

Time : Start: (Example : 06:30:00)

Period : Stop: (Example : 22:30:00)

Interval : Seconds

Manual Operation

Manual Operation : Enable e-mail video to e-mail account

Interval : Seconds

E-mail Account: This field contains the following six basic E-mail settings.

- **SMTP Server Address:** SMTP (Simple Mail Transfer Protocol) is a protocol for sending e-mail messages between servers. You need to input the mail server address in this field.
- **Sender e-mail Address:** Enter the e-mail address of the user who will send the e-mail.
- **Receiver e-mail Address:** Enter the e-mail address of the user who will receive the e-mail.
- **User Name:** Enter the user name in this field.
- **Password:** Enter the user password in this field to log into the mail server.

Time Schedule: Select the “*Enable-mail video to e-mail account*” option to set a schedule to send e-mail. Please refer to the instructions in the “**Upload**” section. The **Interval** option is to define the time interval between the sending of successive images.

Manual Operation: When you click the **E-mail Video** button in the video viewing screen, it will start to e-mail images. The **Interval** option is to define the time interval between the sending of successive images.



Web Configuration

HNC300 Network Camera & HNC320G Wireless-G Network Camera

System Administration: Tools

The **Tools** window contains commands for running basic tests, as well as for upgrading and restarting the camera. Click **Tools** in the top menu bar and the **Tools** window will appear as below:



FTP Server Test

Click on **FTP Server Test** to the right of the text “Internet Camera” to test your FTP server settings.

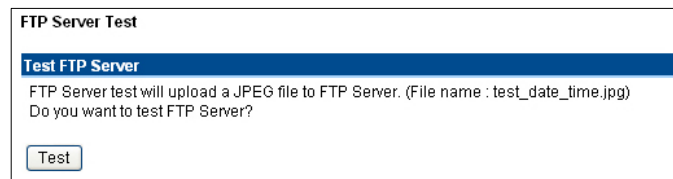

Test FTP Server: Click the *Test* button to test the FTP server settings.

E-mail Test

Click on **E-mail Test** to the right of the text “Internet Camera” to test your e-mail account.

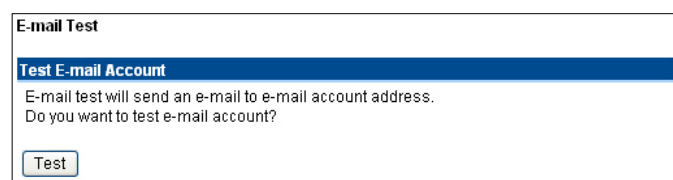

Test E-mail Account: Click the *Test* button to test the e-mail account settings you provided.



Web Configuration

HNC300 Network Camera & HNC320G Wireless-G Network Camera

Reset

“Do you really want to reset this device?” Click the **Yes** button for this option, and you can restart the camera. (This is equivalent to physically turning the camera off and on again; your settings will stay saved. If you do not want to reset the camera, exit this window without clicking **Yes**.)

The screenshot shows a dialog box titled "Reset". It has a blue header bar with the word "Reset" in white. Below the header, the text reads "Do you want to reset this device?". At the bottom left of the dialog, there is a button labeled "Yes".

Factory Reset

“Do you want to restore this device to factory default setting?” If you click the **Yes** button for this option, you can restore all the factory default settings for the camera. If you do not want to restore the factory settings, exit this window without clicking **Yes**. Please NOTE that you have to configure the network settings again after a Factory Reset.

The screenshot shows a dialog box titled "Factory Reset". It has a blue header bar with the words "Factory Reset" in white. Below the header, the text reads "Do you want to restore this device to factory default setting?". At the bottom left of the dialog, there is a button labeled "Yes".

Firmware Upgrade

When a new firmware upgrade is available, you can upgrade it through this window. Click the “**Browse...**” button to locate the firmware file, and then click **Update** to start upgrading.

The screenshot shows a dialog box titled "Firmware Upgrade". It has a blue header bar with the words "Firmware Upgrade" in white. Below the header, the text reads "Current Firmware Version and Date: 3.xx (2005-09-30)". There is a text input field labeled "Select a Firmware File:" followed by a "Browse..." button. At the bottom of the dialog, there are two buttons: "Upgrade" and "Cancel".



Web Configuration

HNC300 Network Camera & HNC320G Wireless-G Network Camera

Backup

Click the **Backup** item in the left column to back up the current configuration.

Backup

Backup Device Configuration to File
Do you want to backup the configuration to file?

Restore Device Configuration from File

Select a Configuration File :

Backup Device Configuration to File: “Do you want to backup the configuration to file?” Click the **Backup** button from this option, and you can save the current configuration to file.

Restore Device Configuration from File: You can restore the device configuration from a saved file in the computer. Click the “**Browse...**” button to locate the file, and then click **Restore** to start restoring.



Web Configuration

HNC300 Network Camera & HNC320G Wireless-G Network Camera

System Administration: Help

The **Help** window provides the camera's most basic information. Click **Help** in the top menu bar and the Help window will appear as below:

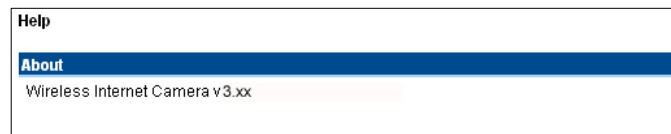

About

Displays the camera's model name and version.

Once the configuration is completed, click **Home** to return to the Welcome screen and select the desired video viewing option either through **ActiveX Mode** or **Java Mode** as described in the next section.

Then, position the camera in the desired location. Then, adjust the camera focus. You can do this manually by turning the lens clockwise or counter-clockwise until you achieve the desired image clarity. Please refer to *Appendix F* for more detailed instructions.



Web Configuration

HNC300 Network Camera & HNC320G Wireless-G Network Camera

HNC320G

System Administration: Management

The Management window contains the information you will need to configure your camera. Click the items in the menu bar to the right of the text “Internet Camera” to view your settings, including: **System**, **Video**, **Wireless**, **Network**, and **User**.

HAWKING TECHNOLOGY
Management | Configuration | Tools | Help | Home

Internet Camera

System | Video | Wireless | Network | User

System

Device Status

Camera Name	: Hawking NetCam
Location	: Warehouse
Model	: HNC320G
Firmware Version	: 3.xx (2005-09-30)
MAC Address	: 00 FF 11 11 66 00
IP Address	: 192.168.0.20

Ethernet Status

Link	: Yes
Speed	: 100Mbps
Duplex	: Full Duplex

System

Click **System** to the right of the text “Internet Camera” to display the device status of your camera.

Device Status	
Camera Name	: Hawking NetCam
Location	: Warehouse
Model	: HNC320G
Firmware Version	: 3.xx (2005-09-30)
MAC Address	: 00 FF 11 11 66 00
IP Address	: 192.168.0.20
Ethernet Status	
Link	: Yes
Speed	: 100Mbps
Duplex	: Full Duplex
<input type="button" value="Refresh"/>	

- **Device Status:** The camera’s vital information, including the Camera Name, Location, Model, Firmware Version, MAC Address and IP Address, can be found in this field.
- **Ethernet Status:** You can monitor the camera’s network status in this field, including Link (network connection), Speed, and the Duplex mode.



Web Configuration

HNC300 Network Camera & HNC320G Wireless-G Network Camera

Video

Click **Video** to the right of the text “Internet Camera” to display your camera’s video configuration information.

Video	
Video Status	
Video Resolution	: 320 x 240
Compression Rate	: Medium
Frame Rate	: Auto
Frame Size	: 7904 Bytes
Light Frequency	: 60 Hz
<input type="button" value="Refresh"/>	

- **Video Status:** The camera’s video configuration information, including the Video Resolution, Compression Rate, Frame Rate, Frame Size and IP Address, can be found in this field.

Wireless

Click on **Wireless** to the right of the text “Internet Camera” to display the wireless LAN information.

Wireless	
Wireless Status	
Connection Mode	: Infrastructure
Link	: No
SSID	: default (MAC: 00 00 00 00 00 00)
Channel	: 11
Transmission Rate	: 54Mbps
Encryption	: Disable
<input type="button" value="Refresh"/>	

- **Wireless Status:** The items in this field display the wireless LAN information, such as the Connection Mode (Infrastructure or Ad-Hoc), Link status, SSID, Channel, Transmission Rate, and WEP Encryption.



Web Configuration

HNC300 Network Camera & HNC320G Wireless-G Network Camera

Network

Click **Network** to the right of the text “Internet Camera” to display the camera’s network status information.

Network	
Network Status	
IP Address	: 192.168.0.20
Subnet Mask	: 255.255.255.0
Default Gateway	: 0.0.0.0
Primary DNS Address	: 0.0.0.0
Secondary DNS Address	: 0.0.0.0
Dynamic DNS	: Disabled
Secondary HTTP Port	: Disabled (Port: 81)
UPnP	: Enabled (IP: 0.0.0.0)
FTP Server Test	:
E-mail Test	:

- **Network Status:** The items in this field display the camera’s network status information, such as the IP Address, Subnet Mask, Default Gateway, Primary DNS Address, Secondary DNS Address, Dynamic DNS, Secondary HTTP Port, and UPnP.

User

Click **User** to the right of the text “Internet Camera” to display the user(s) information.

User			
Active Users			
IP Address	Name	DateTime	Milliseconds / Packet

- **Active Users:** The items in this field display the user information, including the user IP address, Name, and Date & Time.



Web Configuration

HNC300 Network Camera & HNC320G Wireless-G Network Camera

System Administration: Configuration

The **Configuration** window contains commands for settings that are required for inputting key details to set up the camera for operation. Click **Configuration** in the top menu bar and the Configuration window will appear as below:

HAWKING TECHNOLOGY
Management | Configuration | Tools | Help | Home

Internet Camera

System | Video | Wireless | Network | User | Date/Time | Upload | E-mail

System

System Setting

Camera Name :

Location :

Admin : Admin ID :

Admin Password :

Confirm Again :

LED Control : Normal OFF Dummy

System

Click on **System** to the right of the text “Internet Camera” to adjust your camera’s basic configuration settings.

System

System Setting

Camera Name :

Location :

Admin : Admin ID :

Admin Password :

Confirm Again :

LED Control : Normal OFF Dummy

System Setting: In this field, you can configure your camera’s basic settings.



Web Configuration

HNC300 Network Camera & HNC320G Wireless-G Network Camera

- **Camera Name:** This field is used to enter a descriptive name for the device. The default setting for the Camera Name is **CS-xxxxxx**, where “xxxxxx” constitutes the last six digits of the device’s MAC Address. The maximum length is 32 characters (printable ASCII).
- **Location:** This field is used to enter a descriptive name for the camera’s location.
- **Admin:** The fields in this section are used to enter the administrator’s name (“Admin ID”) and password. The administrator’s ID and password will allow the user to access and configure the System Administration settings. Be sure to enter the password twice to confirm the details, once in the **Admin Password** field and again in the **Confirm Password** field.

The default settings for both the administrator user name and password are **blank** (or null string). The administrator name (“Admin ID”) has a maximum length of 12 (printable ASCII) characters and the administrator password has a maximum length of 8 (printable ASCII) characters.

It is highly recommended that you set the Admin ID and Admin Password as soon as possible to enable security options for the camera.

NOTE: If you would like to create a user account that only has access to the video image, but not the system administration settings, you can do this in the “User” page of the Configuration section. Instructions on how to create such a user are provided in the pages that follow.

- **LED Control:** This option allows users to set up the LEDs, as desired. This feature provides flexibility when surveillance activity is ON.

There are three options, and they are as follows:

Normal	Power - Steady On Link - Steady On Note: When there is LAN activity, the LED indicator will flash steadily.
OFF	Power - LED indicator is off. Link - LED indicator is off.
Dummy	Power - Steady On Link - Steady On, with random flashing.

The default setting for the LED control is **Normal**. When you have configured the LED controls, the correct illumination will set after 1 minute.



Web Configuration

HNC300 Network Camera & HNC320G Wireless-G Network Camera

Video

Click **Video** to the right of the text “Internet Camera” to configure the camera’s video settings.

Video

Video Setting

Video Resolution : 160 x 120 320 x 240 640 x 480

Compression Rate : Very Low Low Medium High Very High

Frame Rate : 1 5 7 15 20 Auto (Frames/Sec.)

Brightness Control :

Contrast Control :

Saturation Control :

Light Frequency : 50 Hz 60 Hz

Mirror : Horizontal Mirror Vertical Mirror

Anti-Flicker :

Video Setting: In this field, you can configure the camera’s basic video settings.

- **Video Resolution:** Select the desired video resolution format: **160 x 120**, **320 x 240** (default), or **640 x 480**.
- **Compression Rate:** Select the desired compression rate. You will have five levels to choose from, ranging from **Very Low** to **Very High**. A higher video compression rate will generate a more compact file size with poorer video quality, and vice-versa. The default setting is **Medium**.
- **Frame Rate:** Select the desired frame rate. The default setting is **Auto** for an optimal frame rate.
- **Brightness Control:** Adjust the brightness level; the default setting is **64**.
- **Contrast Control:** Adjust the contrast level; the default setting is **64**.
- **Saturation Control:** Adjust the saturation level; the default setting is **64**.
- **Light Frequency:** Adjust the light frequency to suit your area of operation. The options are: **50 Hz** or **60 Hz** (60Hz is the default).
- **Mirror:** Select **Horizontal Mirror** to flip the image horizontally, or **Vertical Mirror** to flip the image vertically.
- **Anti-Flicker:** If you capture a flickering image because of the environment factor (for example, from the intense light from a lamp), please select this item to solve the problem.



Web Configuration

HNC300 Network Camera & HNC320G Wireless-G Network Camera

Wireless

Click on **Wireless** to the right of the text “Internet Camera” to configure the wireless LAN settings for your wireless camera.

The screenshot shows the 'Internet Camera' web configuration page. The 'Wireless' section is active, showing 'Connection Mode' set to 'Infrastructure'. The 'SSID' field is empty, with a 'Site Survey' button below it. The 'Encryption' section is also visible, with 'Disable' selected. The 'Advanced Setting' section shows 'Beacon Interval' set to 100 ms and 'Preamble' set to 'Long'.

Wireless Interface

- **Connection Mode:** Use this option to determine the type of wireless communication for your camera. There are two choices: Infrastructure mode and Ad-Hoc mode. The default setting is **Infrastructure**.
- **SSID:** The SSID (Service Set Identifier) is the name assigned to the wireless network. Clicking on “Site Survey” will auto-detect and display the SSID of the wireless network in this box (it displays **default** initially). This default setting will let the camera connect to ANY access point under the infrastructure network mode. To connect the camera to a specific access point on the network, please make sure to set the SSID of the camera to correspond with the access point’s SSID for communication. Type any string up to 32 characters long (spaces, symbols, and punctuation are not allowed) in the SSID box.



Web Configuration

HNC300 Network Camera & HNC320G Wireless-G Network Camera

To connect the camera to an Ad-Hoc wireless workgroup, make sure that you set the same wireless channel and SSID to match with the PC/Notebook's configuration for direct wireless communication.

- **Wireless Channel:** This pull-down menu allows you to select the appropriate wireless channel for communication. A "channel" is a range of frequencies to be used in communication between the camera and access point in Infrastructure mode, or the camera and PC/Notebook in Ad-Hoc mode. Select the appropriate channel from the list provided (depending on the regulatory region where the unit is sold). The default setting is at channel *11*.
- **Transmission Rate:** Select the data transmit rate from this pull-down menu. The default setting is *Fully Automatic*.

WEP Encryption

- **WEP Encryption:** Wireless network communications can be intercepted easily. WEP (Wired Equivalent Privacy) is an encryption method specified by the IEEE 802.11g standard to make any intercepted communications extremely difficult to interpret by unauthorized parties. The default setting for this option is *Disable*. But it is recommended that you either enable WEP encryption or utilize the more advanced form of encryption, WPA-PSK. The WPA-PSK settings are described in the section near the bottom of this page.
- **WEP Key Format:** To enable WEP Encryption, you should decide the encryption format first by selecting the *ASCII* or *HEX* option, and then input the WEP key (in the following Key 1 - 4 box).

ASCII input format:

ASCII format causes each character you type to be interpreted as an eight-bit value. All unaccented upper- and lower-case Western European characters that can be input through your keyboard's typing zone are valid. To setup a 64-bit WEP key, input 5 ASCII characters. For example, '12345'. To setup a 128-bit WEP key, input 13 ASCII characters. For example, '1234567890123'. These character counts result in bit counts of 40 and 104 respectively; the camera will automatically pad your input to a bit count of 64 or 128.

HEX input format:

Hex format causes each pair of characters you type to be interpreted as an eight-bit value in hexadecimal (base 16) notation. Only the digits 0 through 9 and the letters A through F (in upper or lower case) are valid. To setup a 64-bit WEP key, input 10 characters in HEX format. For example, '3132333435' (which is the same as an ASCII input of '12345'). To set up a 128-bit WEP key, input 26 characters in HEX format. For example, '31323334353637383930313233', (which is the same with ASCII input '1234567890123'). These character counts result in bit counts of 40 and 104, respectively; the wireless network camera will automatically pad your input to a bit count of 64 or 128.

- **Encrypt Data Transmissions Using:** Use this pull-down menu to decide whether to use Key 1, 2, 3 or 4 for encryption).
- **WPA-PSK:** This item is used to secure your wireless network in pre-shared key mode (8-63 ASCII or 64 HEX characters). If you enable this function, each user must enter a pass phrase to access the network.



Web Configuration

HNC300 Network Camera & HNC320G Wireless-G Network Camera

Advanced Setting: In this field, you can configure more advanced settings.

- **Beacon Interval:** This option defines the time interval between two images sent in succession.
- **Preamble:** A preamble is a signal used in wireless environments to synchronize the transmission timing, including Synchronization and Start frame delimiter. Please NOTE that if you want to change the Preamble type from *Long* to *Short*, you will need to check the access point's settings.
- **Authentication Type:** *Open System* communicates the key across the network. *Shared Key* allows communication only with other devices with identical WEP settings. The default setting is *Both*.



Web Configuration

HNC300 Network Camera & HNC320G Wireless-G Network Camera

Network

Click on **Network** to the right of the text “Internet Camera” to configure the LAN settings for your camera.

Network

TCP/IP

IP Address Mode : Fixed IP

IP Address : 192.168.0.20

Subnet Mask : 255.255.255.0

Default Gateway : 0.0.0.0

Dynamic IP (DHCP)

PPPoE

User ID :

Password :

DNS IP Address : 1. 0.0.0.0

2. 0.0.0.0

Dynamic DNS : Enable Disable

Service Provider :

Host Name :

User Name/E-mail :

Password/Key :

Second HTTP Port : Enable Disable

Port Number :

UPnP : Enable Disable

TCP/IP:

- **IP Address Mode:** This field provides you with three options. They are as follows:
 - **Fixed IP** – You can select this option and enter the IP address directly. The default settings are:
 - IP Address – 192.168.0.20
 - Subnet Mask – 255.255.255.0
 - Default Gateway – 0.0.0.0

Dynamic Address (DHCP) – If your network uses a DHCP server, you may select this option. According to this setting, the camera will automatically be assigned an IP address from the DHCP server. Once you click “Save” at the bottom of the page, wait for the camera to reboot (this could take up to one minute). After the camera has finished rebooting, you can locate the camera’s new IP address via the camera’s Setup Wizard utility. The new IP address should appear under the “Current IP Address” heading in the utility. (If you have multiple cameras on the network, you may need to test the newly assigned IP addresses to locate the camera you have just configured.)

PLEASE NOTE: If you want to be certain of your camera’s IP address at all times, “Fixed IP” is the preferred option.



Web Configuration

HNC300 Network Camera & HNC320G Wireless-G Network Camera

PPPoE – If your application requires a direct connection from an ADSL modem through the camera’s RJ-45 LAN port, click this option and enter the User ID and Password into the respective boxes. (*You should have an ISP PPPoE account.*) The camera will get an IP address from the ISP when it starts up.

- **DNS IP Address:** A DNS (Domain Name System) server is an Internet service that translates domain names into IP addresses. Enter at least one DNS IP Address in this field.
- **Dynamic DNS:** The Dynamic DNS service allows you to alias a dynamic IP address to a static hostname in any of the domains, allowing your computer to be accessed more easily from various locations on the Internet.
- **Second HTTP Port:** The default port for communication is via port 80, and you can change it according to your network configuration. Select **Enable** from the option and enter the desired port number in the appropriate box.

The **Second HTTP Port** field allows you to open a second port for the network camera. This will permit users’ routers to support *multiple* network cameras. By default, Port 80 (on the router) is always open for network camera web server access.

For example, assume you have five network cameras to be installed, with the following IP addresses:

192.168.0.101
192.168.0.102
192.168.0.103
192.168.0.104
192.168.0.105

You can open the second port for each network camera, from port 81 to Port 85, as illustrated below:

Internet Camera 1 – IP 192.168.0.101, second web port 81
Internet Camera 2 – IP 192.168.0.102, second web port 82
Internet Camera 3 – IP 192.168.0.103, second web port 83
Internet Camera 4 – IP 192.168.0.104, second web port 84
Internet Camera 5 – IP 192.168.0.105, second web port 85

You also need to setup your router for Port Mapping.

Port 81 map to 192.168.0.101
Port 82 map to 192.168.0.102
Port 83 map to 192.168.0.103
Port 84 map to 192.168.0.104
Port 85 map to 192.168.0.105

Save/Cancel:

After making sure that all settings in the System are correct, click on the **“Save”** button to store the settings for the network camera. You can alternatively click on the **“Cancel”** button to restore all settings to the values last saved to or retrieved from the network camera.

- **UPnP:** UPnP is the architecture for pervasive peer-to-peer network connectivity of intelligent appliances and PCs of all form factors. Check the **Enable** option to enable the function on your camera.



User

Click on **User** to the right of the text “Internet Camera” to add, edit and delete users for your camera.

The screenshot shows a web interface for user management. It is titled "User" and contains two main sections: "User Access Control" and "Define Users".

User Access Control: This section has a header "User Access Control" and a label "Access Control :". Below it are two radio buttons: "Enable" (unselected) and "Disable" (selected). There are "Save" and "Cancel" buttons below the radio buttons.

Define Users: This section has a header "Define Users" and contains three main areas:

- Add User:** A label "Add User :". Below it are two input fields: "User Name" and "User Password". To the right of the "User Password" field is an "Add" button.
- Delete User:** A label "Delete User :". Below it is a pull-down menu (currently showing a downward arrow) and a "Delete" button.
- User List:** A label "User List :". Below it is a table with the header "UserTable". The table has two columns: "Name" and "Upload/E-mail Video".

User Access Control:

- **Access Control:** The administrator has the authority to give specific users permission to control the device and make configuration changes by selecting **Enable** or **Disable**. The default setting is **Disable**. When the “Access Control” setting is set to “Disable” for a specific user, that user will only be able to view the image, and will not be able to make any configuration changes to the device.

Define Users: Use this field to add or delete users for your camera.

- **Add User:** Enter the user name in this box, and enter the password that was assigned by the administrator for this user. The maximum password length is 8 (printable ASCII) characters. The administrator has the authority to give specific users permission to control the **Upload/E-mail Video** control by selecting **Yes** or **No** to activate the **Upload/E-mail Video**. To add a new user’s name, enter the necessary information first and click the **Add** button.
- **Delete User:** Select the user you want to delete from the pull-down menu, and then click the **Delete** button.
- **User List:** This list displays the camera’s current user status.



Web Configuration

HNC300 Network Camera & HNC320G Wireless-G Network Camera

DateTime

Click on **DateTime** to right of the text “Internet Camera” to set up the time and date for your camera.

Date & Time Setting

Date & Time : Synchronized with Time Server

IP Address :

Protocol : NTP Time

TimeZone :

Set Manually

Date : (Example : 2004-09-01)

Time : (Example : 06:12:35)

Synchronized with Computer Time

Date & Time: You can set up the time and date automatically by selecting the *Synchronized with Time Server* option, or manually in the *Set Manually* section.

- **Synchronized with Time Server:** Select this option to set the time according to the GMT setting. The time will be synchronized every 10 minutes. When selecting this option, you have to enter the required information in the following fields:
 - IP Address** – Enter the IP Address of the Time Server in this box.
 - Protocol** – You can select from two options, *NTP* or *Time*, to link with the Time Server. The default setting is *NTP*.
 - TimeZone** – Select the time zone for the region from the pull-down menu.
- **Set Manually:** Select this option to set the time manually. The system administrator must manually enter the date and time in the respective field.



Web Configuration

HNC300 Network Camera & HNC320G Wireless-G Network Camera

Upload

Click on **Upload** to the right of the text “Internet Camera” to set up the configuration for the FTP server, time schedule, and manual operation.

Upload

FTP Server

Host Address :

Port Number : (Default is 21)

User Name :

Password :

Directory Path :

Passive Mode : Yes No

Time Schedule

Time : Enable upload video to FTP server

Schedule

Always

Schedule

Day : Mon Tue Wed Thu Fri Sat Sun

Time : Start: (Example : 06:30:00)

Period : Stop: (Example : 22:30:00)

Video Frequency: Frames/Second

Seconds/Frame

Base File Name :

File : Overwrite

Date/Time Suffix

Sequence Number Suffix Up to

Manual Operation

Manual Operation : Enable upload video to FTP server

Base File Name :

File : Overwrite

Date/Time Suffix

Sequence Number Suffix Up to

FTP Server: This field contains the following six basic settings for your FTP server.

- **Host Address:** The IP Address of the target FTP server.
- **Port Number:** The standard port number for the FTP server is Port **21**, which is also the default setting. If the FTP server uses a different port, please confirm this with the IT manager.
- **User Name:** Enter the user name in this field.
- **Password:** Enter the user password in this field to login into the FTP server.
- **Directory Path:** Enter an existing folder name in this field, and the images will be uploaded to the given folder.
- **Passive Mode:** This function depends on your FTP server. Please check with your IT manager if the FTP server uses passive mode. The default setting is **No**.



Web Configuration

HNC300 Network Camera & HNC320G Wireless-G Network Camera

Time Schedule: Select the “*Enable upload video to FTP server*” option and enter the relevant information, such as the schedule, video frequency and base file name.

- **Schedule:** You can 1.) Choose *Always* to always upload the video to the FTP server, or 2.) Set a *Schedule* to manage the uploading task. In the Schedule option, you can set the *Day* and *Time Period* options.
- **Video Frequency:** There are two ways to set the video frequency: 1.) Set *Auto/1/2/3* frames per second, or 2.) Set the time, in seconds, for every frame.
- **Base File Name:** Enter the file name to make sure that the images are saved using this base file name.
- **File:** Since it is likely that you will upload more than one image to the FTP server, you can choose the filing rule, including *Overwrite*, *Date/Time Suffix*, and set up the *Sequence Number*.

Manual Operation: When you click the *Upload Video* button in the video viewing screen, it will start to upload the image. The settings refer to the *Base File Name* and *File* information above.



Web Configuration

HNC300 Network Camera & HNC320G Wireless-G Network Camera

Email

Click on **E-mail** to the right of the text “Internet Camera” to configure the E-mail account, time schedule and manual operation settings.

E-mail

E-mail Account

SMTP Server Address :

Sender e-mail Address :

Receiver e-mail Address :

User Name :

Password :

Time Schedule

Time : Enable e-mail video to e-mail account

Schedule

Always

Schedule

Day : Mon Tue Wed Thu Fri Sat Sun

Time : Start: (Example : 06:30:00)

Period : Stop: (Example : 22:30:00)

Interval : Seconds

Manual Operation

Manual Operation : Enable e-mail video to e-mail account

Interval : Seconds

E-mail Account: This field contains the following six basic E-mail settings.

- **SMTP Server Address:** SMTP (Simple Mail Transfer Protocol) is a protocol for sending e-mail messages between servers. You need to input the mail server address in this field.
- **Sender e-mail Address:** Enter the e-mail address of the user who will send the e-mail.
- **Receiver e-mail Address:** Enter the e-mail address of the user who will receive the e-mail.
- **User Name:** Enter the user name in this field.
- **Password:** Enter the user password in this field to log into the mail server.

Time Schedule: Select the “*Enable-mail video to e-mail account*” option to set a schedule to send e-mail. Please refer to the instructions in the “**Upload**” section. The **Interval** option is to define the time interval between the sending of successive images.

Manual Operation: When you click the **E-mail Video** button in the video viewing screen, it will start to e-mail images. The **Interval** option is to define the time interval between the sending of successive images.



Web Configuration

HNC300 Network Camera & HNC320G Wireless-G Network Camera

System Administration: Tools

The **Tools** window contains commands for running basic tests, as well as for upgrading and restarting the camera. Click **Tools** in the top menu bar and the **Tools** window will appear as below:



FTP Server Test

Click on **FTP Server Test** to the right of the text “Internet Camera” to test your FTP server settings.

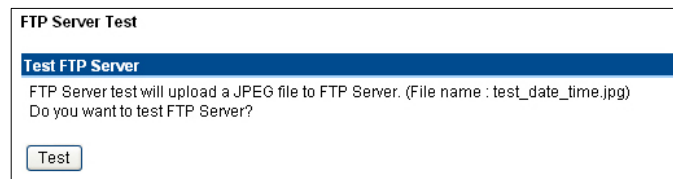

Test FTP Server: Click the *Test* button to test the FTP server settings.

E-mail Test

Click on **E-mail Test** to the right of the text “Internet Camera” to test your e-mail account.

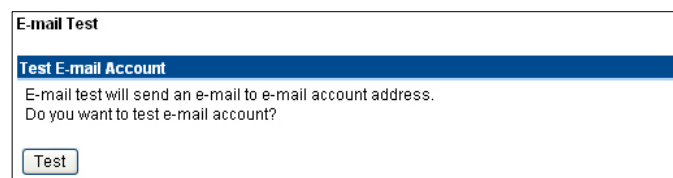

Test E-mail Account: Click the *Test* button to test the e-mail account settings you provided.



Web Configuration

HNC300 Network Camera & HNC320G Wireless-G Network Camera

Reset

“Do you really want to reset this device?” Click the **Yes** button for this option, and you can restart the camera. (This is equivalent to physically turning the camera off and on again; your settings will stay saved. If you do not want to reset the camera, exit this window without clicking **Yes**.)

The screenshot shows a dialog box titled "Reset". It has a blue header bar with the word "Reset" in white. Below the header, the text reads "Do you want to reset this device?". At the bottom left of the dialog, there is a button labeled "Yes".

Factory Reset

“Do you want to restore this device to factory default setting?” If you click the **Yes** button for this option, you can restore all the factory default settings for the camera. If you do not want to restore the factory settings, exit this window without clicking **Yes**. Please NOTE that you have to configure the network settings again after a Factory Reset.

The screenshot shows a dialog box titled "Factory Reset". It has a blue header bar with the words "Factory Reset" in white. Below the header, the text reads "Do you want to restore this device to factory default setting?". At the bottom left of the dialog, there is a button labeled "Yes".

Firmware Upgrade

When a new firmware upgrade is available, you can upgrade it through this window. Click the “**Browse...**” button to locate the firmware file, and then click **Update** to start upgrading.

The screenshot shows a dialog box titled "Firmware Upgrade". It has a blue header bar with the words "Firmware Upgrade" in white. Below the header, the text reads "Current Firmware Version and Date: 3.xx (2005-09-30)". There is a text input field labeled "Select a Firmware File:" followed by a "Browse..." button. At the bottom of the dialog, there are two buttons: "Upgrade" and "Cancel".



Web Configuration

HNC300 Network Camera & HNC320G Wireless-G Network Camera

Backup

Click the **Backup** item in the left column to back up the current configuration.

Backup

Backup Device Configuration to File
Do you want to backup the configuration to file?

Restore Device Configuration from File

Select a Configuration File :

Backup Device Configuration to File: “Do you want to backup the configuration to file?” Click the **Backup** button from this option, and you can save the current configuration to file.

Restore Device Configuration from File: You can restore the device configuration from a saved file in the computer. Click the “**Browse...**” button to locate the file, and then click **Restore** to start restoring.



Web Configuration

HNC300 Network Camera & HNC320G Wireless-G Network Camera

System Administration: Help

The **Help** window provides the camera's most basic information. Click **Help** in the top menu bar and the Help window will appear as below:

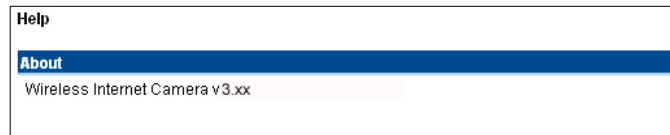

About

Displays the camera's model name and version.

Once the configuration is completed, click **Home** to return to the Welcome screen and select the desired video viewing option either through **ActiveX Mode** or **Java Mode** as described in the next section.

Then, position the camera in the desired location. Then, adjust the camera focus. You can do this manually by turning the lens clockwise or counter-clockwise until you achieve the desired image clarity. Please refer to *Appendix F* for more detailed instructions.



Web Configuration

HNC300 Network Camera & HNC320G Wireless-G Network Camera

View Image - ActiveX Mode

To view video images from the web browser, click on “**View Image – ActiveX Mode**” on the welcome screen to access the video images from Internet Explorer, as illustrated below:

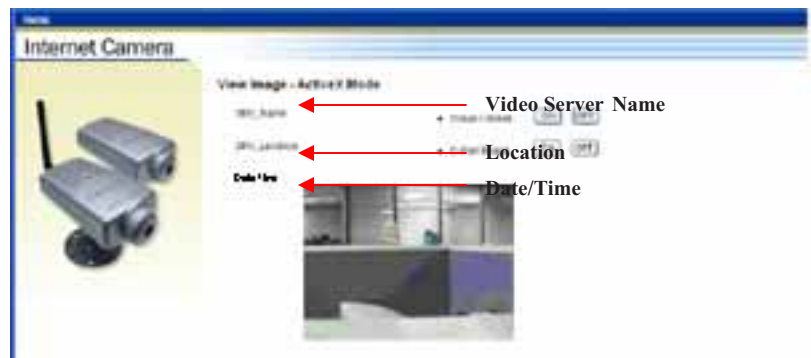

Camera Name* - The Camera name will be display when the Camera Name field is entered in the Web Configuration setting under “System”

Location**- The location of the Internet Camera will be displayed when the Location field is entered in the Web Configuration settings under “System”.

Date/Time***- The date/time of the video server will show the date and time which come from time server or you set manually.

Note:

Please refer to the appendix on how to install ActiveX.

1. *Install to the Web Server*
2. *Install to your Local PC*

In the View Image – **ActiveX Mode** you are allowed two output trigger options and one image upload option. Just click on the desired selection “**ON**” or “**OFF**” to utilize the options for each of the functions.

Note 1:

Administrator has the authority to set the email image functions through the setting in the “E-mail” of System Administration menu bar.

Note 2:

The Administrator has the authority to allow user’s to set the image upload functions through the setting in the “Upload” of System Administration menu bar.



Web Configuration

HNC300 Network Camera & HNC320G Wireless-G Network Camera

View Image – Java Mode

Click on “**View Image – Java Mode**” from the Welcome screen to access the video images from the Internet Explorer or Netscape browser as illustrated below:

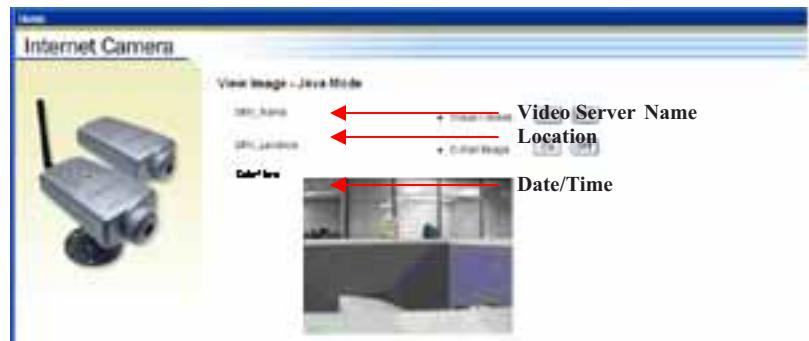

Camera Name* - The camera name will be displayed when the Camera Name field is entered in the Web Configuration setting under “**Configuration**”

Location** - The location of the Internet Video Server will be displayed when the Location field is entered in the Web Configuration settings under “**System**”.

Date/Time***- The date/time of the wireless internet video server will show the date and time which come from time server or you set manually.

In the View Image – **ActiveX Mode** you are allowed two output trigger options and one image upload option. Just click on the desired selection “**ON**” or “**OFF**” to utilize the options for each of the functions.

NOTE:

1. Please refer to the appendix on how to install ActiveX, including: 1.) Installing to the Web Server, and 2.) Installing to your Local PC.
2. The administrator has the authority to set the upload video function through the setting in the **Upload** option under **Configuration**.
2. The administrator has the authority to set the e-mail video function through the setting in the **E-mail** option under **Configuration**.



Camera Applications

HNC300 Network Camera & HNC320G Wireless-G Network Camera

The HNC300/HNC320G can be utilized in wide variety of applications. The cameras are all-in-one devices and can be attached directly to an Ethernet or Fast Ethernet network. The HNC320G also supports the IEEE 802.11b/g standard. The cameras are standalone systems with built-in CPUs, along with web-based solutions that allow the devices to transmit high quality video images for monitoring purposes. They can be managed remotely, and can be accessed and controlled from any PC over the Intranet or Internet via a web browser. With the IPView SE application, you can further expand the scope of the HNC300/HNC320G.

This chapter will provide typical applications for the HNC300/HNC320G and IPView SE software, and includes some basic knowledge to assist in the installation and configuration of the cameras.

Applications

- Monitoring of local and remote places and objects such as construction sites, hospitals, amusement parks, schools and day-care centers via a web browser.
- Using the IPView SE software application, you can capture single frame images or video images.

Home Applications

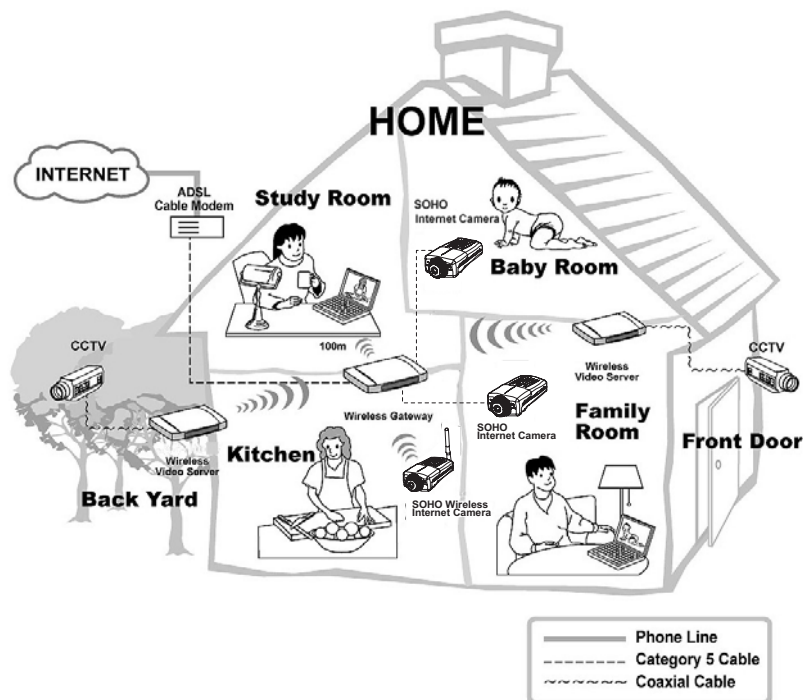



Camera Applications

HNC300 Network Camera & HNC320G Wireless-G Network Camera

SOHO (Small Office, Home Office) Applications

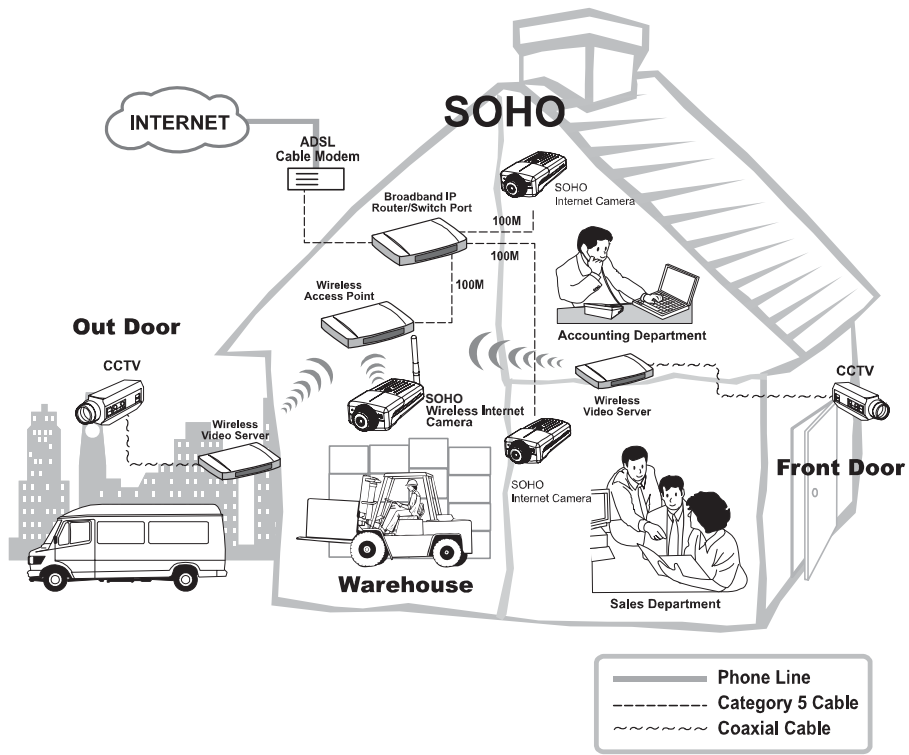



IPView SE Application Installation

HNC300 Network Camera & HNC320G Wireless-G Network Camera

Installation

Insert the CD-ROM into the CD-ROM drive to initiate the auto-run program. Once completed, a menu screen will appear as follows:





IPView SE Application Installation

HNC300 Network Camera & HNC320G Wireless-G Network Camera

To install the IPView SE application, click on **“Install IPView Software”** to activate the installation procedure for the application program.

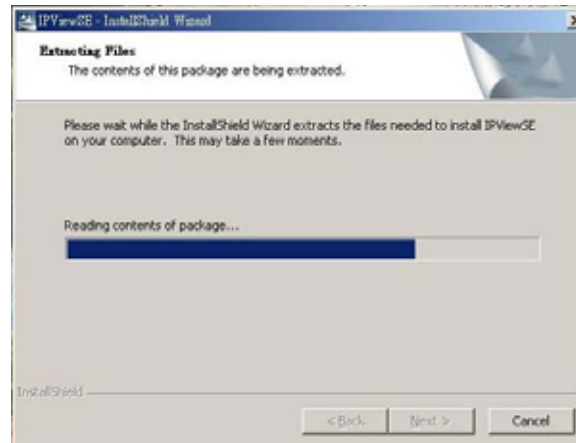

Once executed, a prompt will appear and request the input of the desired language selection. Make the desired selection and click on **“OK”** to continue.

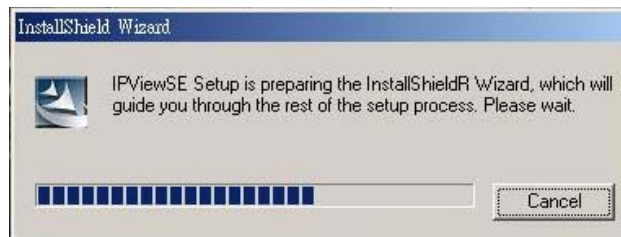

The Welcome screen will appear. Click on the **“Next”** button to proceed with the installation.

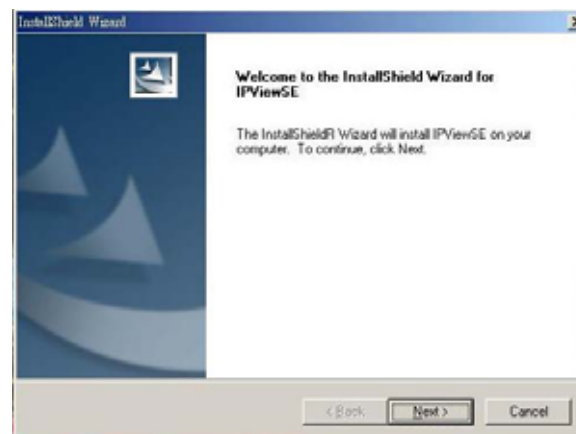



IPView SE Application Installation

HNC300 Network Camera & HNC320G Wireless-G Network Camera

The License Agreement prompt will appear, as below. Read the details carefully and click on the “Yes” button to continue with the installation procedure.



A prompt will appear and in the Destination Location dialog box, you may click on “Next” to accept the recommended destination location or click on “Browse” to select another location. After specifying the desired destination location, click on “Next” to proceed.

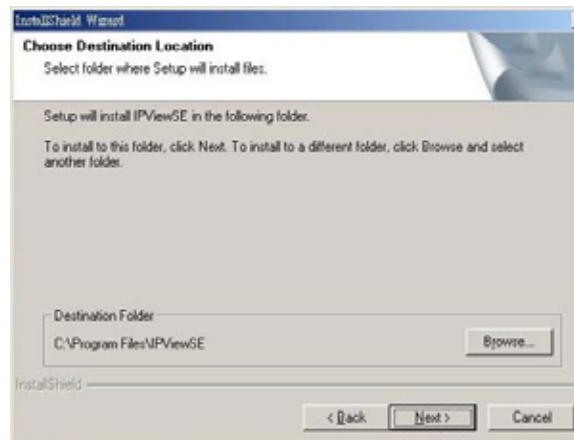



IPView SE Application Installation

HNC300 Network Camera & HNC320G Wireless-G Network Camera

The Select Program Folder prompt will appear, providing information on where the IPView SE application will be located. Click on “**Next**” to continue. If you wish to modify your settings, click on “**Back**” to return to the previous screens.

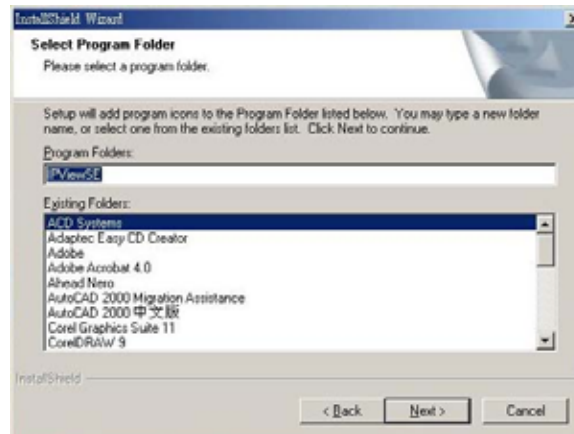

Please wait until one of the two dialog boxes appears, and then select “*Yes, I want to restart my computer now*” and click on the “**Finish**” button to restart the computer to complete the installation procedure.

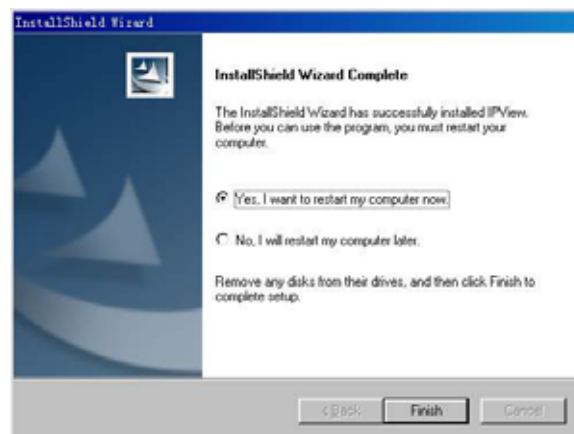

IPView SE Application Installation

HNC300 Network Camera & HNC320G Wireless-G Network Camera

Or click on the “**Finish**” button to complete the installation procedure.

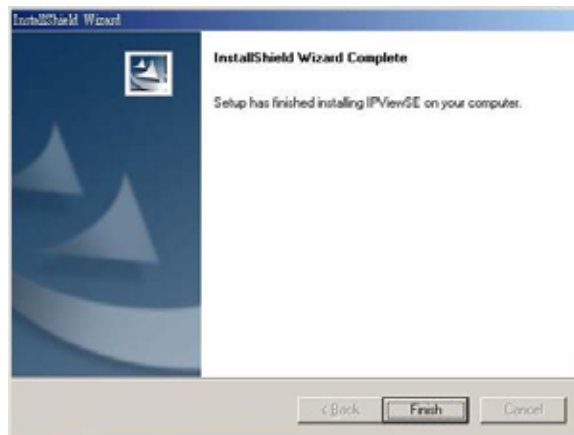

After successfully installing the IPView SE software application, the application program for the HNC300/HNC320G is automatically installed to \Programs\Files Directory.

To start running IPView SE, click on **Start Menu/Programs/IPView SE /IPView SE**.



Once you log in, the IPView SE application will execute and the application’s interface will appear as below in the default List View format:





IPView SE - Getting Started

HNC300 Network Camera & HNC320G Wireless-G Network Camera

This section describes the operation of the IPView SE application User Interface with detailed explanations of procedures for using the application. IPView SE is responsible for management of the preview, configuration, and search of each camera. It incorporates a user-friendly interface for ease of control and navigation, as illustrated below.

IPView SE Control Panel

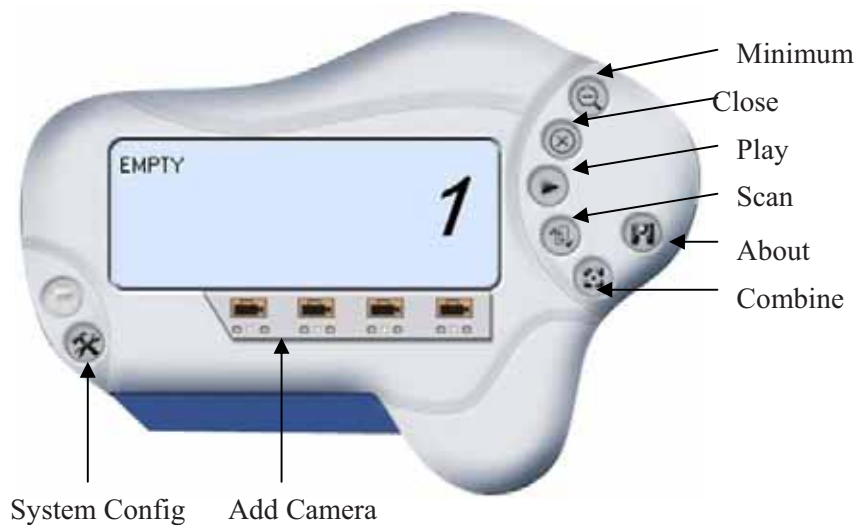

Minimum – Minimizes the control panel.



Close – Closes the control panel.



Play – Plays back the recording file.



Scan – Searches for all network cameras available on the LAN. (At minimum, this function will locate any Hawking cameras that have the code “HCVT” located beneath the UPC code on the product packaging or within the serial number that appears on the white sticker label of the product. However, this function may be able to locate other network cameras on the LAN that do not have this code.)



Combine – Combines all display windows into one window.



About – Displays information about the IPView SE application.

How to Add a Camera



Add Camera

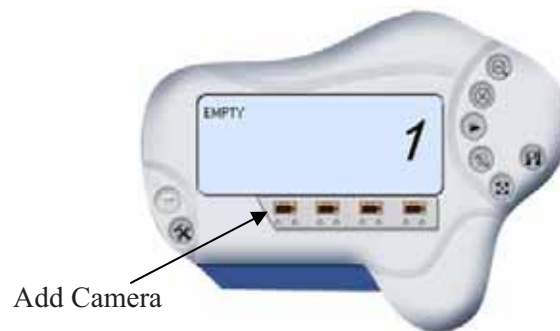

Click on **Add Camera** icon to add a new camera. An **Add Camera** dialog box will appear, as illustrated below.

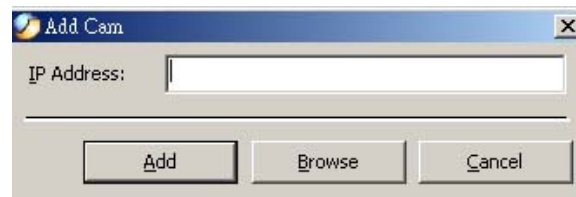

You can enter the IP Address of the camera in the specified field and click the “**Add**” icon to add a new camera.

Note 1:

1. If you want to add a camera via the Internet, you must key in a physical IP Address.
2. When the camera is installed behind the router/gateway and the Open Second Port of the camera /Port Forwarding of the router/gateway function is enabled, the Gateway IP address must be entered with the Port Number, as below:

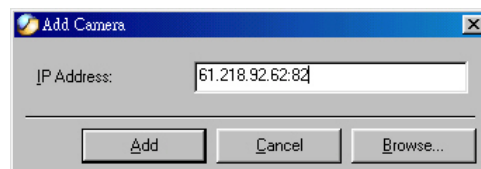

IPView SE - Getting Started

HNC300 Network Camera & HNC320G Wireless-G Network Camera

3. At the same time, the Gateway IP address can be replaced by URL as below:

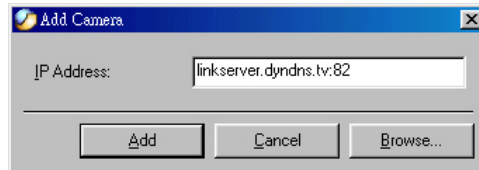

4. If you incorrectly input the IP Address you wish to add, a dialog box will appear to notify you of the error.



If you are unsure of the camera's IP address, you can click on the “**Browse**” button, and the **Browse Camera** dialog box will appear with a blank screen, as illustrated below.

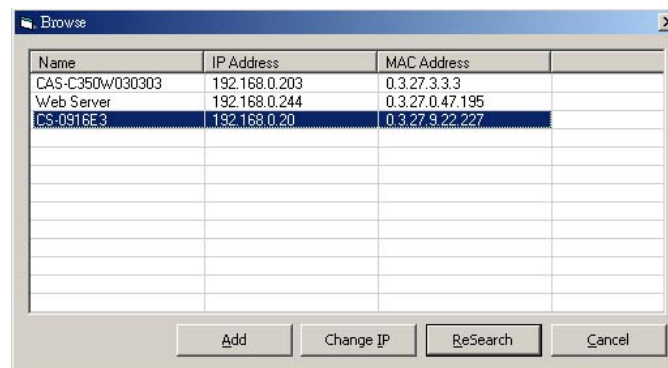

You must select the camera and click on the “**Add**” button to add a new camera. The **Add Camera** dialog box will appear once again, this time with the IP Address entered. Click on the “**Add**” icon and the camera will be automatically added into IPView SE list view format.

IPView SE - Getting Started

HNC300 Network Camera & HNC320G Wireless-G Network Camera

If the **Login Camera** dialog box appears, make sure to enter the correct **User Name** and **Password** and click on the **“OK”** button and the camera will be added into IPView SE in list format. If the **User Name** and **Password** are entered incorrectly, the camera will not be added into IPView SE.



The above dialog box will appear only if the administrator has already set the **User Name** and **Password** during the Web Configuration setting.

If you forget to highlight the camera you wish to add, a dialog box will appear to notify you of the error.



Make sure to save any changes you have made to keep the information updated.

Note 2:

You can only add one camera at a time.

When the user adds the network camera, four icons will appear: “Assign IP to Camera”, “Connect / Disconnect”, “Erase”, “Extra Information”



IPView SE - Getting Started

HNC300 Network Camera & HNC320G Wireless-G Network Camera

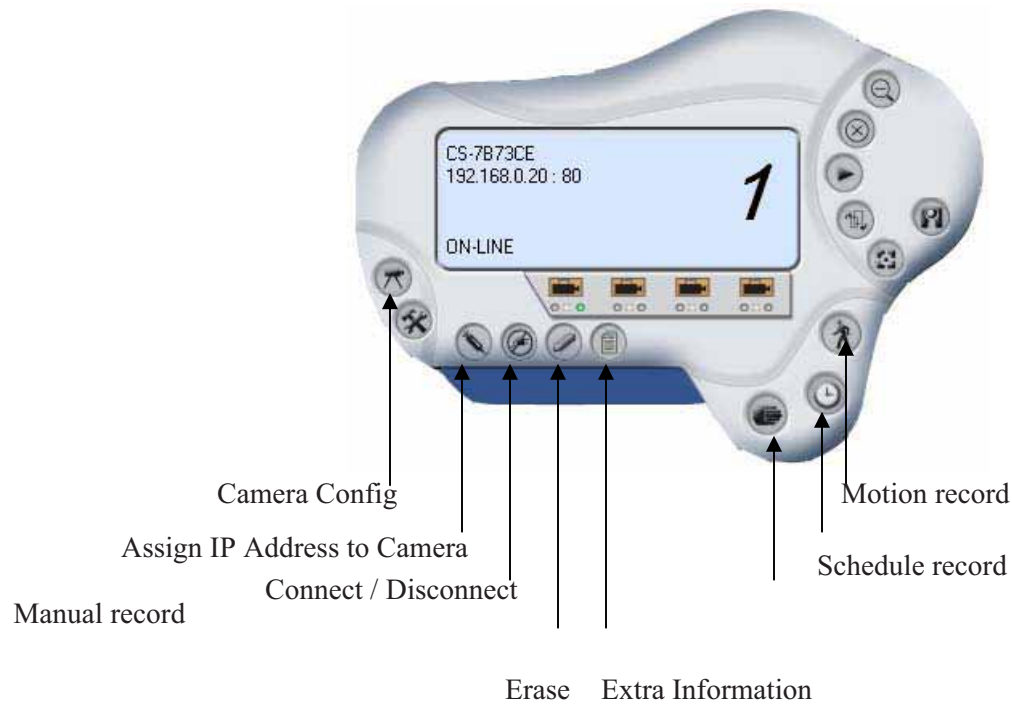

How to Change Cameras



Assign IP of New Camera

To change cameras, click the “Assign IP of Camera” button. An Assign IP of Camera dialog box will appear as illustrated below:

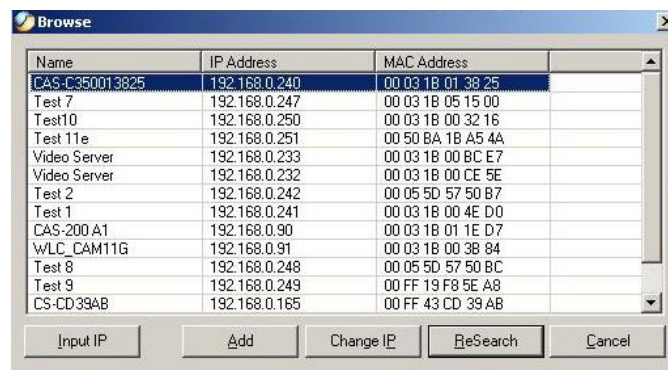

You must select the camera and click the **Add** button to add a new camera.



IPView SE - Getting Started

HNC300 Network Camera & HNC320G Wireless-G Network Camera

How to Connect/Disconnect the Image



Connect the Image - click on the “Connect/Disconnect” button and the preview screen will appear with the video image.

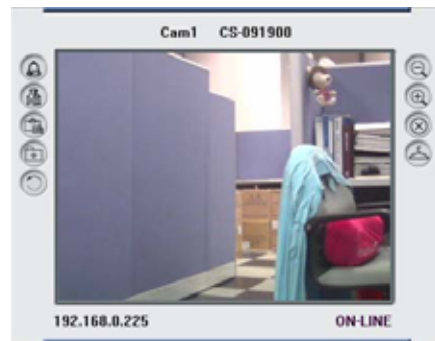

Minimum – Minimizes the display screen of the network camera.



Maximum – Maximizes the display screen of the network camera.



Close – Closes the display screen of the network camera.



Always on top – The display screen will always be on top of the window.



Wake up control panel – Opens the control panel again when it is closed.



Color setting – Adjusts the color setting of the image.



View list – Checks the network camera’s event list.



Snapshot – Commands the network camera to take a snapshot picture.



Rotate image – Rotates the image of the network camera.



Zoom - Click to zoom in and out on the camera’s picture. (Note: The HNC300 and HNC320G feature *digital* zoom, not true optical zoom.)

IPView SE - Getting Started

HNC300 Network Camera & HNC320G Wireless-G Network Camera



Disconnect the Image – Click on the “Connect/Disconnect button again to disconnect the camera.



How to Delete a Camera



Erase Camera – To delete a camera, you must select the camera to delete from the IPView SE control panel. Then click on the “Erase Camera” button. After deleting, the IPView SE control panel will appear as below.





IPView SE - Getting Started

HNC300 Network Camera & HNC320G Wireless-G Network Camera

Extra Information



Extra Information – Lists camera information.



How to Adjust the Property Setting



System Configure – The dialog box below will appear.

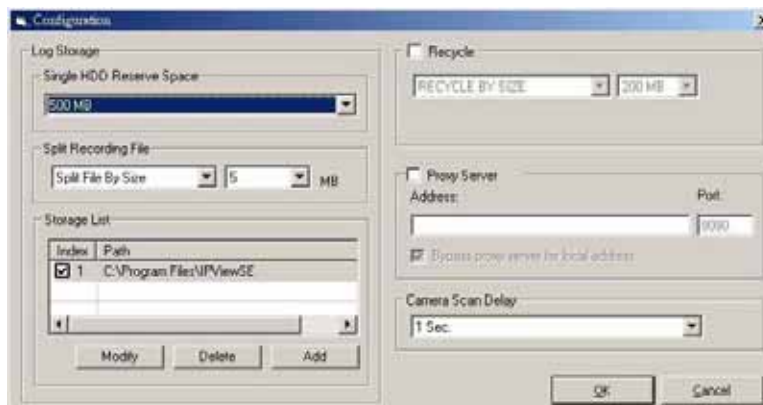

Log Storage:

1. Single HDD Reserve Space:
The “Single HDD Reserve Space” permits reserved space by memory size from 500 MB to 1000 MB.

2. Split Recording File

From the “Split Recording File” you can adjust the file size for recording the video images. (The default size for file size recording is 5MB). If the recorded video files reach the file size, video images will be recorded into another file automatically.

By File Size - permits recording by file memory size from 5 MB to 50 MB.

3. Storage List

This defines the file path to save the image.

The software will create a camera name folder as the “Storage List”, which is allowed to create up to four File Paths.

Recycle:

When you select “Recycle”, the system will recycle the HDD space once the space becomes less than the size defined. The defined size can be from 200 MB to 50000 MB.

Proxy Server:

This can be selected to support a “Proxy server”.

Camera Scan Delay:

This allows full screen display for each camera one by one. The time interval for each camera can be from 1 second to 20 seconds.



Camera Configure – Click on this button to activate the Camera Setting, Motion Setting, and Update Firmware icons.

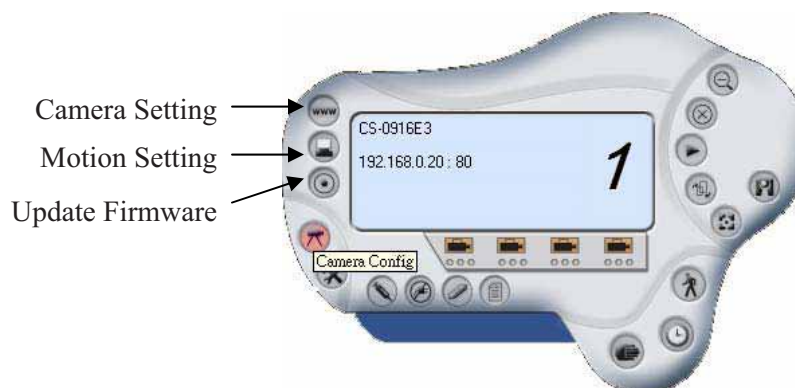

Camera Setting – Refer to the “Web Configuration” section.



Motion Setting – Adjusts the sensitivity level and selects the Invoke Alarm options to work with the motion detection function (if available). Along with Alarm Beep, the Send Email function can also be enabled when motion is detected. The user can define the time interval to send emails.

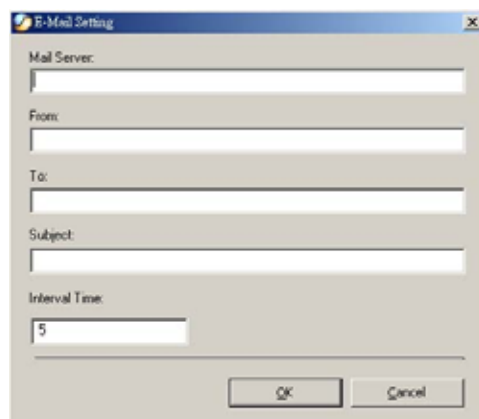
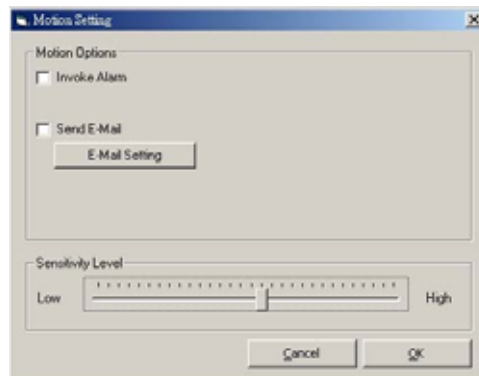

Mail Server: Mail Server IP or name.

Mail From: E-Mail Address of sender.

Mail To: E-Mail Address of receiver.

Subject: Can be any information the user chooses.

User Name: Enter the user name in this field.

Password: Enter the user password in this field to log into the receiver's mail server.

Interval Time: The time interval to send the next E-Mail (the units are in seconds).

IPView SE - Getting Started

HNC300 Network Camera & HNC320G Wireless-G Network Camera



Update Firmware

Click on the “**Update**” button and enter the **File Path**. The firmware will then be updated automatically.

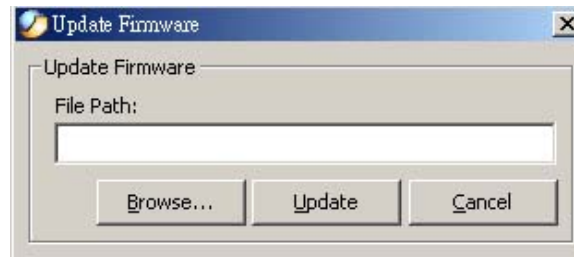

If you are unsure of the File path, you can click on the “**Browse**” icon. The **Browse** dialog box will appear with a blank screen, as illustrated below.



Warning

During the firmware update process, please make sure no interruptions occur, as it may cause serious damage to the camera.



IPView SE - Getting Started

HNC300 Network Camera & HNC320G Wireless-G Network Camera

How to Adjust the Recording Settings

There are three ways to start recording the image: Motion Record, Schedule Record & Manual Record.



Motion Record – Recording is triggered when motion is detected (if the motion detection feature is available). You can adjust the sensitivity level and choose the warning options when motion is detected from the motion setting.



Schedule Record – Triggers recording as scheduled. The schedule is set by date or weekday.



Manual Record – Triggers manual recording.



A. Frequently Asked Questions

Regarding Camera Features

Q: What is an Internet/Network Camera?

A: The HNC300/HNC320G is a standalone system that connects directly to an Ethernet or Fast Ethernet network. The HNC320G also supports wireless transmission based on the IEEE 802.11b/g standard. It is different from a conventional PC Camera in that the HNC300/HNC320G is an all-in-one system with built-in CPU and web-based solutions that provide a low cost solution, which can transmit high quality video images for monitoring. The HNC300/HNC320G can be managed remotely, and can be accessed and controlled from any PC/Notebook over the Intranet or Internet via a web browser.

Q: What is the maximum number of users that can be allowed to access the HNC300/HNC320G simultaneously?

A: The maximum number of users that can log onto the HNC300/HNC320G at the same time is 64. Please keep in mind that the overall performance of the transmission speed will slow down when many users are logged on simultaneously.

Q: What algorithm is used to compress the digital image?

A: The HNC300/HNC320G utilizes the JPEG image compression technology, thereby providing high quality images for users. JPEG technology is utilized since it is a standard for image compression and can be applied to various web browser and application software without the need to install extra software.

For the HNC320G only:

Q: Can I change the wireless antenna that is attached to the HNC320G?

A: The wireless antenna can be changed for such purposes as extending the wireless transmission range. However, please make sure that the connectors of the new antennas are of the SMA connector type. For a full listing of high performance antennas that can be used to replace the standard antenna that has been included with the HNC320G, please visit the Hawking website at: www.hawkingtech.com.

Q: What is the wireless transmission range for the HNC320G?

A: Generally, the wireless distance will reach up to 100 meters indoors and up to 300 meters outdoors. The range is limited by the number of walls, ceilings, or other objects that the wireless signals must pass through. Typical ranges vary depending on the types of materials and background Radio Frequency (RF) noise in your home or business and the configuration setting of your network environment.

HNC300/HNC320G Installation

Q: Can the HNC300/HNC320G be used outdoors?

A: The HNC300/HNC320G is not weatherproof. Outdoor use is **not** recommended. In some cases, the camera can be equipped with a weatherproof case to be used outdoors, but users are advised to use caution when choosing this option.

Q: What network cabling is required for the HNC300/HNC320G?

A: The HNC300/HNC320G uses Category 5 UTP cable for 10 Base-T and 100 Base-TX networking.



Q: Can the HNC300/HNC320G be setup as a PC camera on the computer?

A: No, the HNC300/HNC320G is an Internet/Network Camera and can only be used on Ethernet and Fast Ethernet networks. The HNC320G can also be used in wireless networks.

Q: Can the HNC300/HNC320G be connected on the network if it consists of only private IP addresses?

A: The HNC300/HNC320G can be connected to a LAN with private IP addresses.

Q: Can the HNC300/HNC320G be installed and function properly if a firewall exists on the network?

A: If a firewall exists on the network, port 80 is open for ordinary data communication. However, since the HNC300/HNC320G transmits image data, the default port 8481 is also required. Therefore, it is necessary to open port 8481 on the network for remote users to access the HNC300/HNC320G.

B. Ping Your IP Address

The PING (Packet Internet Groper) command can determine whether a specific IP address is accessible by sending a packet to the specific address and waiting for a reply. It can also provide a very useful tool to confirm if the IP address conflicts with the HNC300/HNC320G on the network.

Follow the step-by-step procedure below to utilize the PING command. But first you must disconnect the HNC300/HNC320G from the network.

Start a DOS window.

Type “ping a.b.c.d”, where “a.b.c.d” is the IP address of the network camera.

C. Troubleshooting

Given below are some helpful explanations to the causes of potential problems that might arise with the HNC300/HNC320G.

Q: I cannot access the Internet Camera from a web browser.

A1: The possible cause might be the network camera’s IP Address if it conflicts with another device. To correct the possible problem, you need to first disconnect the Internet Camera from the network. Then run the PING utility (follow the instructions in Appendix B - PING Your IP Address).

A2: Another possible reason is the IP Address is located on a different subnet. To fix the problem, run the PING utility (follow the instructions in Appendix B - PING Your IP Address). If the utility returns “no response” or similar, the finding is probably correct, then you should proceed as follows:

In Windows 95/98/2000 and Windows NT, double-check that the IP Address of the camera is within the same **subnet** as your workstation.

Click “Start”, “Setting”, “Control Panel”, and the “Network” icon.

Select TCP/IP from the “Network” dialog box, and from the “TCP/IP Properties” dialog box, click on “Specify an IP address”.

If the network camera is situated on a different subnet than your workstation, you will not be able to set the IP address from this workstation. To verify, make sure the first three sections of the IP address of the network camera correspond to the first three sections of the workstation. Thus, the IP address of the camera must be set from a workstation on the same subnet.

A3: Other possible problems might be due to the network cable. Try replacing your network cable. Test the network interface of the product by connecting a local computer to the unit, utilizing a standard crossover (hub to hub) cable. If the problem still cannot be resolved, the network camera may be faulty.

Q: Why is the Power LED not lit continuously?

A: The power supply you are using may be the source of the problem. Confirm that you are using the DC 5V power supply that has been provided with the HNC300/HNC320G and verify that the power supply is well connected.

Q: Why does the Link LED not light up properly?

A1: There might be a problem with the network cable. To confirm that the cables are working, PING the address of a known device on the network. If the cabling is OK and your network is reachable, you should receive a reply similar to the following (...bytes = 32 time = 2 ms).

A2: The network device utilized by the Wireless Internet Camera is not functioning properly such as hubs or switches. Confirm the power for the devices are well connected and functioning.

(For the HNC320G only) A3: The wireless connection might be at fault. In ad-hoc mode, make sure the HNC320G wireless channel and SSID are set to match the PC/Notebook wireless channel and SSID for direct communication. Under infrastructure mode make sure the SSID on the PC/Notebook and the HNC320G must match with the Access Point's SSID.

Q: Why does the HNC300/HNC320G work locally but not externally?

A1: This might be caused by the firewall protection. You will need to check the Internet firewall with your system administrator.

A2: The default router setting might be a possible reason. You will need to double-check if the configuration of the default router settings is required.

Q: Why does a series of broad vertical white lines appear throughout the image?

A: A likely issue is that the network camera's CMOS (see Appendix G – Specifications) sensor becomes overloaded when the light source is too bright, as can occur from direct exposure to sunlight or a halogen light. You need to reposition the camera into a more shaded area immediately, as prolonged exposure will damage the CMOS sensor.

Q: The camera focus is poor. What can I do to fix this?

A1: The focus might not be correctly adjusted for the line of sight. You need to adjust the camera focus manually, by turning the lens either in the clockwise or counterclockwise direction.

A2: There is no adaptor fitted with your C-type lens. If you have previously changed the supplied CS-type lens, you may have unintentionally installed a C-type lens without fitting the adaptor first.

Q: Noisy images occur. What can I do to fix this?

A1: The video images might be noisy if the HNC300/HNC320G is used in a very low light environment. To resolve this issue, place the camera in a location with better lighting.

(For the HNC320G only) A2: There might be wireless transmission interference. Make sure there are no other wireless devices on the network that will affect the wireless transmission.

Q: The image quality is poor. How can I improve the image?

A1: A probable cause might be that the display properties are configured incorrectly on your desktop. You need to open the Display Properties on your desktop and configure your display to show at least 65,000 colors (i.e., at least 16-bit).

Note:

Applying only 16 or 256 colors on your computer will produce dithering artifacts in the image.

A2: The configuration of the HNC300/HNC320G image display is incorrect. Through the Web Configuration Image section, you need to adjust the image related parameters such as brightness, contrast, hue and light frequency. Please refer to the Web Configuration section for detail information.

Q: There are no images available through the web browser.

A: The ActiveX control might be disabled. If you are viewing the images from Internet Explorer make sure ActiveX has been enabled in the Internet Options menu. Alternatively, you can use the Java Applet for viewing the required images.

D. Upgrade Firmware

Users can upgrade the firmware via the IPView SE application. Select **Camera>Properties** and the **Camera Property** dialog box will appear. Select the **Tools** tab and enter the full path of the firmware binary file name in the Update Firmware field, or click on the **“Browse”** button to select the file. Once the firmware file is entered, click on the **“Update”** button to proceed with the updating process. Once completed, click on the **“OK”** button, as illustrated below.



Warning: During the firmware update process, please make sure no interruptions occur as this could cause serious damage to the HNC300/HNC320G.



Appendix

HNC300 Network Camera & HNC320G Wireless-G Network Camera

E. Time Zone Table

(GMT-12:00) Eniwatok, Kwajalein
(GMT-11:00) Midway Island, Samoa
(GMT-10:00) Hawaii
(GMT-09:00) Alaska
(GMT-08:00) Pacific Time (US & Canada); Tijuana
(GMT-07:00) Arizona
(GMT-07:00) Mountain Time (US & Canada)
(GMT-06:00) Central Time (US & Canada)
(GMT-06:00) Mexico City, Tegucigalpa
(GMT-06:00) Saskatchewan
(GMT-05:00) Bogota, Lima, Quito
(GMT-05:00) Eastern Time (US & Canada)
(GMT-05:00) Indiana (East)
(GMT-04:00) Atlantic Time (Canada)
(GMT-04:00) Caracas, La Paz

(GMT-04:00) Santiago
(GMT-03:30) Newfoundland
(GMT-03:00) Brasilia
(GMT-03:00) Buenos Aires, Georgetown
(GMT-02:00) Mid-Atlantic
(GMT-01:00) Azores, Cape Verde Is.
(GMT) Casablanca, Monrovia
(GMT) Greenwich Mean Time : Dublin, Edinburgh, Lisbon, London
(GMT+01:00) Amsterdam, Berlin, Bern, Rome, Stockholm, Vienna
(GMT+01:00) Belgrade, Bratislava, Budapest, Ljubljana, Prague
(GMT+01:00) Brussels, Copenhagen, Madrid, Paris, Vilnius
(GMT+01:00) Sarajevo, Skopje, Sofija, Warsaw, Zagreb
(GMT+02:00) Athens, Istanbul, Minsk
(GMT+02:00) Bucharest
(GMT+02:00) Cairo

(GMT+02:00) Harare, Pretoria
(GMT+02:00) Helsinki, Riga, Tallinn
(GMT+02:00) Jerusalem
(GMT+03:00) Baghdad, Kuwait, Riyadh
(GMT+03:00) Moscow, St. Petersburg, Volgograd
(GMT+03:00) Nairobi
(GMT+03:30) Tehran
(GMT+04:00) Abu Dhabi, Muscat
(GMT+04:00) Baku, Tbilisi
(GMT+04:30) Kabul
(GMT+05:00) Ekaterinburg
(GMT+05:00) Islamabad, Karachi, Tashkent
(GMT+05:30) Bombay, Calcutta, Madras, New Delhi
(GMT+06:00) Astana, Almaty, Dhaka
(GMT+06:00) Colombo

(GMT+07:00) Bangkok, Hanoi, Jakarta
(GMT+08:00) Beijing, Chongqing, Hong Kong, Urumqi
(GMT+08:00) Perth
(GMT+08:00) Singapore
(GMT+08:00) Taipei
(GMT+09:00) Osaka, Sapporo, Tokyo
(GMT+09:00) Seoul
(GMT+09:00) Yakutsk
(GMT+09:30) Adelaide
(GMT+09:30) Darwin
(GMT+10:00) Brisbane
(GMT+10:00) Canberra, Melbourne, Sydney
(GMT+10:00) Guam, Port Moresby
(GMT+10:00) Hobart
(GMT+10:00) Vladivostok



HNC300 Network Camera & HNC320G Wireless-G Network Camera

(GMT+08:00) Singapore
(GMT+08:00) Taipei
(GMT+09:00) Osaka, Sapporo, Tokyo
(GMT+09:00) Seoul
(GMT+09:00) Yakutsk
(GMT+09:30) Adelaide
(GMT+09:30) Darwin
(GMT+10:00) Brisbane
(GMT+10:00) Canberra, Melbourne, Sydney
(GMT+10:00) Guam, Port Moresby
(GMT+10:00) Hobart
(GMT+10:00) Vladivostok
(GMT+11:00) Magadan, Solomon Is., New Caledonia
(GMT+12:00) Auckland, Wellington
(GMT+12:00) Fiji, Kamchatka, Marshall Is.

F. Xplug Control Installation

Installation To Web Server

Important Information

It is highly recommended to install the Xplug Control application to the Web Server for IE 5.0. It must be installed to a Public Domain with a Fixed IP address.

1. Installation:

Copy the “xplug.ocx” file to any WEB Server table.

2. Setting (Configuration):

From the Web Configuration menu, select “System” and under the “Loading ActiveX From” input web server location

(http://www.web_server_location.com/).

Once the settings are completed the user now is able to access the network camera from the web browser by selecting the image view – ActiveX mode.

Installation To Local PC

Insert the CD-ROM into the CD-ROM drive to initiate the auto-run program. Once completed, a menu screen will appear, as follows:



To install the Xplug Control (ActiveX control), click on the **"Install X Plug"** button to activate the installation procedure for the plug-in program.

Once executed, a prompt will appear and request the input of the desired language selection. Make the desired selection and click on **"OK"** to continue.



The Welcome screen will appear. Click on the “**Next**” button to proceed with the installation.

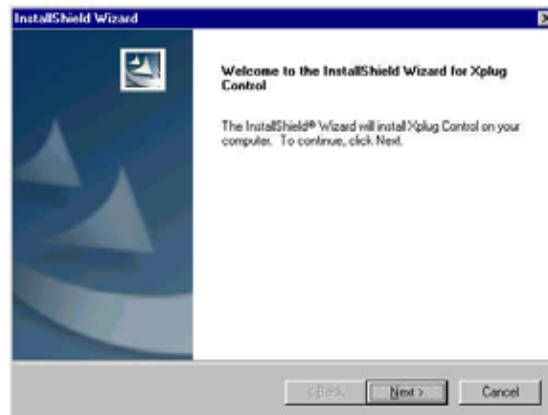

The License Agreement prompt will appear as below. Read the details carefully and click on the “**Yes**” button to continue with the installation procedure.

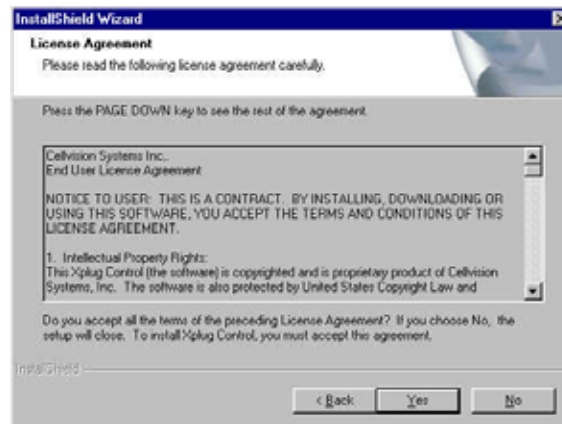

Click on the “**Finish**” button to complete the setup of the Xplug Control Utility program for the network camera.

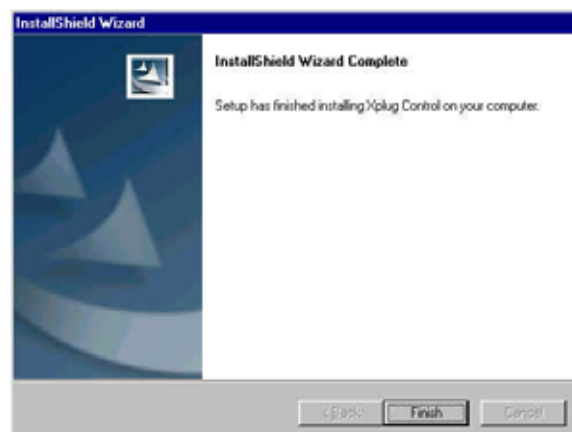



Appendix

HNC300 Network Camera & HNC320G Wireless-G Network Camera

G. Adjusting the Camera Focus

The HNC300/HNC320G features an exchangeable CS-type lens that can be used for different applications as necessary. It supports rotational focus control so the lens can be adjusted to focus under normal and stable conditions to maximize the image quality of the camera.

To adjust the focus of the lens, you need to turn the lens slowly in either the clockwise or counterclockwise direction until the desired image quality is reached. Do not over turn the lens in either of the directions, as it will be out of focus. Unless you wish to replace the lens, do not unscrew the lens more than 1.0mm apart from the Fixed Lens Assembly.

Note:

You can further adjust the network camera's image quality via the Web Configuration under **System Administration - Image**. Please refer to the Web Configuration section for further details.

Warning: Direct exposure to sunlight may cause permanent damage to the network camera's CMOS sensor. Therefore, do not expose the network camera's lens directly to sunlight. When operation is required in an environment with glaring or excessively bright light, it is recommended to use an iris lens. The network camera is designed for indoor usage and if your application requires prolonged exposure to sunlight, a sun visor is recommended to protect the camera.



Appendix

HNC300 Network Camera & HNC320G Wireless-G Network Camera

H. Specifications

HNC300

Video Specifications

Resolution:	640 x 480 pixel
Sensor:	1/3" color CMOS sensor
Gain control:	Automatic
Exposure:	Automatic
White Balance:	Automatic
Shutter:	Electronics 1/60 ~ 1/15000 sec
Minimum Illumination:	2.5 lux@f1.4, 3000K color
Focal Length:	6.0 mm
Aperture:	F=1.8
Signal/ Noise ratio	57dB
Focus Extent:	20 cm - ∞

Image (Video Setting)

Image compression:	JPEG
Frame rate:	30fps @ QCIF, 20fps @ CIF, 6fps @ VGA
Compression Rate selection:	Auto
Frame rate setting:	1, 5, 7, 15, 20, auto (depends on the video format)
Video resolution:	160 x 120, 320x240, 640x480
Digital Zoom:	Supported (4x digital zoom)
Horizontal/Vertical Mirror:	Supported

Hardware Interface

LAN Connector:	One RJ-45 port to connect to 10/100Mbps Ethernet, auto-sensed
LED Indicator:	Power LED (Blue) Link LED (Orange)

Note:

There are three mode settings for the LEDs (Normal / Off / Dummy), which can be changed via the software.

Power Supply:	DC 5V, switching type
Power Communication:	3.5 Watt (700mA x 5V)

Communication Support

Communication:	10/100Mbps Ethernet only
Communication protocols:	HTTP, FTP, TCP/IP, UDP, ARP, ICMP, BOOTP, RARP, DHCP, PPPoE, SMTP, DDNS, UPnP

RAM:	8MB
Flash ROM:	2MB



Appendix

HNC300 Network Camera & HNC320G Wireless-G Network Camera

Browser Support

System requirements:

CPU: Pentium II, 266 MHz or above
Memory Size: 32 MB (64 MB recommended)
VGA card resolution: 800x600 or above

- Internet Explorer 5.0 or above (ActiveX & JAVA Mode – View Images with Windows OS; JAVA Mode – View Images with other OS)
- Netscape 6.0 or above (JAVA Mode – View Image)

IPView SE Application

Supported OS: Win 98 SE, Win 2000, Win ME, Win XP

System requirements for IPView:

CPU: Pentium III, 450 MHz or above
Memory Size: 128 MB (256 MB recommended)
VGA card resolution: 800x600 or above

Operating Environment

Operating temperature: 5°C - 40°C
Storage temperature: -25°C - 50°C
Humidity: 5% ~ 95% non-condensing

EMI

FCC, CE



Appendix

HNC300 Network Camera & HNC320G Wireless-G Network Camera

HNC320G

Video specification

Resolution:	640 x 480 pixel
Sensor:	1/3" color CMOS sensor
Gain control:	Automatic
Exposure:	Automatic
White Balance:	Automatic
Shutter:	Electronics 1/60 ~ 1/15000 sec
Minimum Illumination:	2.5lux@f1.4, 3000K color
Focal Length:	6.0 mm
Aperture:	F=1.8
Focus Extent:	20 cm - ∞

Image (Video Setting)

Image compression:	JPEG
Frame rate:	30fps @ QCIF, 20fps @ CIF, 6fps @ VGA
Compression Rate selection:	Auto
Frame rate setting:	1, 5, 7, 15, 20, auto (depends on the video format)
Video resolution:	160x120, 320x240, 640x480
Digital Zoom:	Supported (4x digital zoom)
Horizontal/Vertical Mirror:	Supported

Hardware Interface

LAN Connector:	One RJ-45 port to connect to 10/100Mbps Ethernet, auto-sensed
Wireless LAN:	Built-in 802.11g wireless LAN module (Wi-Fi compliant)
LED Indicator:	Power LED (Blue) Link LED (Orange)

Note:

There are three mode settings for the LEDs (Normal / Off / Dummy), which can be changed via the software.

Power Supply:	DC 5V, switching type
Power Communication:	5 Watt (1000mA x 5V)
Antenna Connector:	1 connector

Communication Support

Communication:	10/100Mbps Ethernet and 802.11b/g wireless LAN.
Communication protocol:	HTTP, FTP, TCP/IP, UDP, ARP, ICMP, BOOTP, RARP, DHCP, PPPoE, SMTP, DDNS, UPnP



Appendix

HNC300 Network Camera & HNC320G Wireless-G Network Camera

Browser Support

System requirements:

CPU: Pentium II, 266 MHz or above
Memory Size: 32 MB (64 MB recommended)
VGA card resolution: 800x600 or above

- Internet Explorer 5.0 or above (ActiveX & JAVA Mode - View Images for windows OS; JAVA Mode –View Images for other OS)
- Netscape 6.0 or above (JAVA Mode - View Image)

IPView SE Application

Supported OS: Win 98 SE, Win 2000, Win ME, Win XP

System requirements for IPView:

CPU: Pentium III, 450 MHz or above
Memory Size: 128 MB (256 MB recommended)
VGA card resolution: 800x600 or above

Operating environment

Operating temperature: 5°C - 40°C
Storage temperature: -25°C - 50°C
Humidity: 5% ~ 95% non-condensing

EMI

FCC, CE

I. How to View Your Camera via the Internet

The steps outlined below will help you install your camera behind a router:

1. Camera Identification

Open the camera's web page by typing its IP address in your web browser, and click on "Configuration". If you are not taken directly to the "System" page, click on "System". If you intend to install multiple cameras, it is recommended that you give each camera a unique "Camera Name" and "Location" in the fields provided.



2. Ensure that the Camera Has a Local IP Address

You will need a *local* IP address to install the camera and to be able to view it within the local area network (LAN). If you have already installed the camera, then you will have already obtained a local IP address via the Setup Wizard or web browser. You can go back to the Setup Wizard or the camera's web page at any time to change the camera's IP address. On the camera's web page, you can set the IP address under the heading "Network" in the "Configuration" section. The camera settings must correspond with your network's existing settings. Please note that the "Default Gateway" is your router's *local* IP Address.

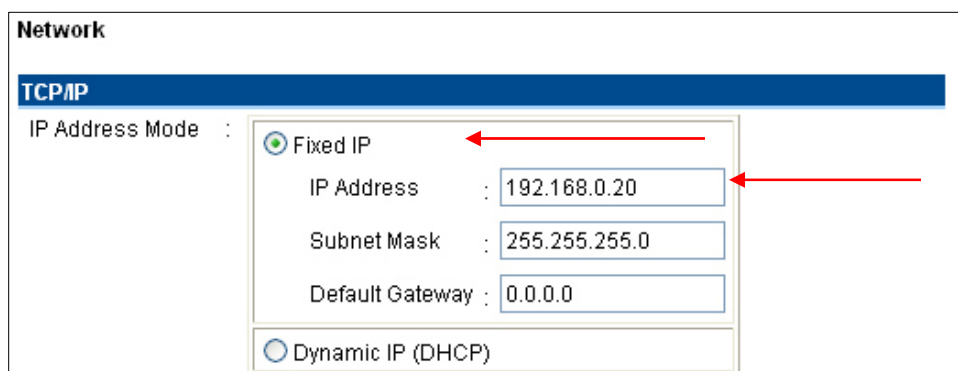

3. Opening a Second Port

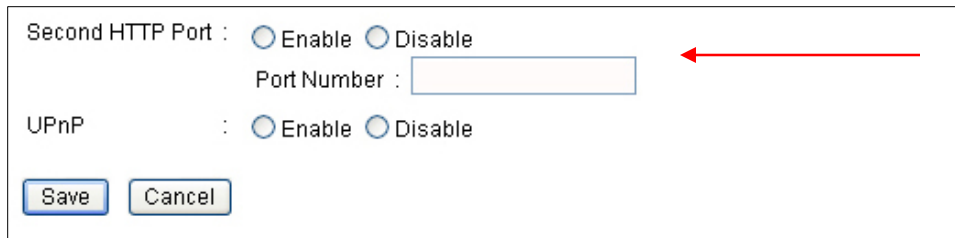

Second HTTP Port : Enable Disable
Port Number :

UPnP : Enable Disable

You will need to open unique ports for each camera in order to be able to view them remotely over the Internet. The “Second HTTP Port” option in the “Network” page of the camera’s “Configuration” section is used for two reasons: a. if you need to use ports other than the default Port 80 for viewing, and b. when more than one camera is being installed on the network. Please note that if you are using only one camera, you can use the default port without having to open a second port. Please also note that when installing the camera behind a router, you will need to open the corresponding ports (same as the open camera ports) on the *router* for *remote* viewing (i.e., over the Internet). In some instances when installing behind a router, Port 80 may not be available; please check your network settings or with your ISP to confirm. In the “Network” section of the network camera’s “Configuration” section, the “Second HTTP Port” field allows for the opening of a second port for the network camera. Select “Enable” and then type a port number in the field provided. This will permit users’ routers to support multiple network cameras. By default, Port 80 (on the router) is always open for network camera web server access. For each additional camera that you intend to install, to enable remote viewing, you will need to enable the “Second HTTP Port” option and assign a port number.

For example, assume that you have five network cameras that need to be installed and they have the following IP addresses:

192.168.0.101
192.168.0.102
192.168.0.103
192.168.0.104
192.168.0.105

You can open the second port for each network camera, from port 81 to Port 85, as illustrated below:

Internet Camera 1 – IP 192.168.0.101, second “HTTP” port 81
Internet Camera 2 – IP 192.168.0.102, second “HTTP” port 82
Internet Camera 3 – IP 192.168.0.103, second “HTTP” port 83
Internet Camera 4 – IP 192.168.0.104, second “HTTP” port 84
Internet Camera 5 – IP 192.168.0.105, second “HTTP” port 85

For multiple cameras, if you choose to use the default IP address of 192.168.0.20, it is recommended that you assign it to the last camera you install. This will help you avoid any conflicts among the IP addresses.

To view the camera over the Internet, you will need to configure your router for Port Mapping. The router's user manual will include instructions on how to do this. The remainder of Appendix I. will also include basic setup instructions on how to view the camera via the Internet. Please remember that for multiple cameras, you will need to open two ports per camera on your router: a. the web server port, and b. the image transfer port.

Save/Cancel:

After making sure that all settings in the "System" section are correct, click on the "Save" button to store the settings for the network camera. You can alternatively click on the "Cancel" button to restore all settings to the values last saved to or retrieved from the network camera.

Steps 4 and 5 are applicable to any router you may have installed on your network.

4. Locate, Make a Note of Your Router's WAN (Public) IP Address



You will need to go to the router's web page (by typing in its *local* IP address in the web address bar) and find the "Status" (or similar) page. On this page, you should be able to locate the router's IP address. This IP address is the router's *public* IP address and will be *different* from its local IP address. You will use this IP

address when enabling your camera to be viewed over the Internet. To view your camera remotely via the Internet, it is recommended (but not required) that you assign a static IP address to your router. You will need to contact your ISP to obtain a static IP address. When the camera is attached to the router, the static IP address will allow you to view the camera over the Internet. If you intend to view your camera from a remote location, it is recommended that, in a secure location, you make a note of this IP address for future reference. It is still possible to view your camera over the Internet with a dynamic IP address (using DHCP) for your router, but this is not the preferred method. With the dynamic option, your router's IP address will change periodically. Therefore, when the router's IP address changes, unless you intend to check the router's "Status" page regularly or you (and all authorized viewers) know the router's IP address at all times, you will not be able to view the camera over the Internet. (With the dynamic option, only the router's *public* IP address will change. The local IP address will remain the same. Therefore, you will still be able to access the camera and all other clients on the local area network from within the network.)

5. Use Port Mapping to Assign Virtual Server Ports

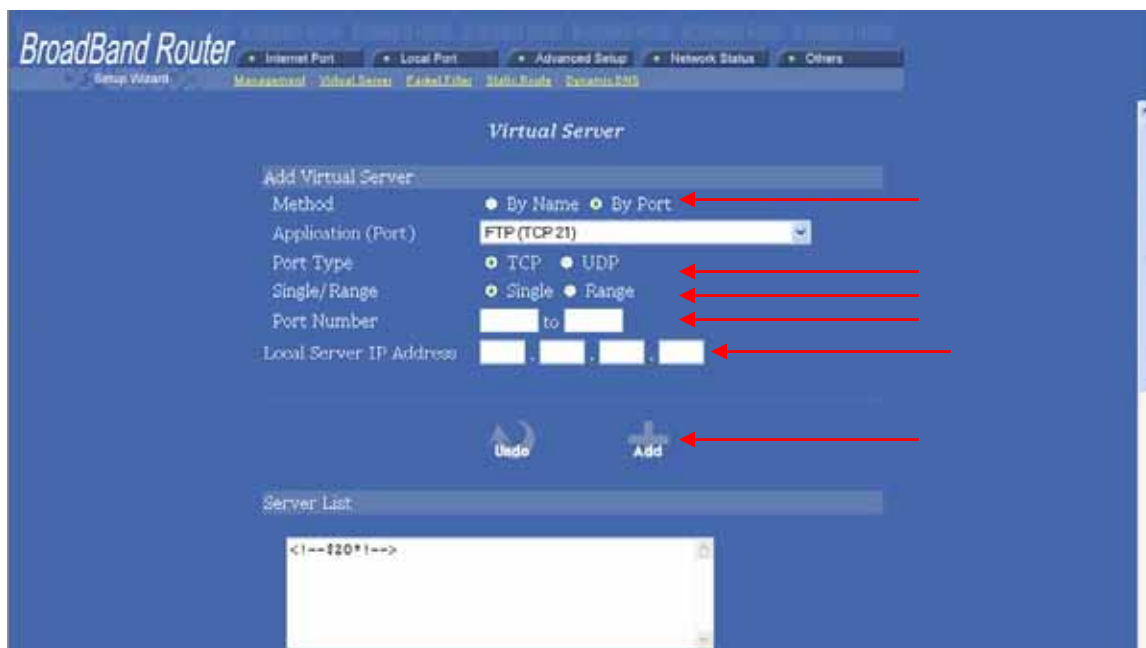

Typically, there is an "Advanced Setup" (or similar) section on the router's web page where you can find a "Virtual Server" or "Port Mapping" sub-section. To enable remote viewing over the Internet for your camera, you will need to open *virtual server ports* on your router. The steps outlined below should be similar for most routers:

- i. Once you have located the "Virtual Server" (or similar) section, select the "By Port" method if this option is available.
- ii. Select "TCP" in the "Port Type" field.
- iii. Next, select "Single" if a "Single/Range" option is available. This is so that you can open individual ports rather than a range of them.

- iv. In the “Port Number” field, enter “Port 80 to Port 80” if you intend to use the camera’s default port settings (discussed earlier in this Appendix). If you do not intend to use the default settings, or if you will be using multiple cameras, you will need to enter a different port number (i.e., 83, 84, etc.). The “Port Number” field, for example, will then read “Port 83 to Port 83”, etc. In this case, the private Port 83 will now be opened as a public port. Please make sure that the public and private ports match (i.e., Port 83 to Port 83). Please also remember that for multiple cameras, you will need to open *two* ports for each camera (as discussed earlier in this Appendix). Therefore, for the camera for which you just opened Port 83, you will also need to open a second port such as Port 8484. In the “Port Number” field, enter “Port 8484 to Port 8484”.
- v. After opening each port, click on “Add” (see figure on previous page).

6. Viewing the Camera from Outside the Network

Once the settings have been correctly entered and saved, authorized users can access the camera from outside the local area network as well as from within. To access the camera from outside the local area network in a remote location via the Internet, type (in sequence) the router’s public IP address, a colon, and the port number assigned to the camera, in the address bar of your web browser. For example, if your router has a public IP address of “64.82.99.33”, you would type the following into the address bar (assuming you assigned Port 85 to the camera): “http://64.82.99.33:85”. From within the network, you would still use the camera’s local IP address to access the camera. For example, if you decided to keep the default local IP address for the camera, from within the network you would simply type: “http:// 192.168.0.20”. (Although, typing in the router’s public IP address, followed by a colon and port number, would work as well.)

J. Glossary of Terms

Numbers

- 10BASE-T 10BASE-T is (10Mbps) Ethernet over UTP Category III,IV, or V unshielded twisted-pair media.
- 100BASE-TX The two-pair twisted-media implementation of 100BASE-T is called 100BASE-TX (100Mbps Fast Ethernet).
- 802.11g An IEEE standard for wireless local area networks. It offers transmissions speeds of up to 54 Mbps in the 2.4-GHz band.

A

- Access point A device that acts as the hardware interface between a wireless LAN and a wired LAN. The access point attaches to the wired LAN through an Ethernet connection.
- Applet Applets are small Java programs that can be embedded in an HTML page. The rule at the moment is that an applet can only make an Internet connection to the computer from which the applet was sent.
- ASCII American Standard Code For Information Interchange. It is the standard method for encoding characters as 8-bit sequences of binary numbers, allowing a maximum of 256 characters.
- ARP Address Resolution Protocol. ARP is a protocol that resides at the TCP/IP Internet layer, which delivers data on the same network by translating an IP address to a physical address.
- AVI Audio Video Interleave. This is a Windows platform audio and video file type, a common format for small movies and videos.

B

- BOOTP Bootstrap Protocol. An Internet protocol that can automatically configure a network device in a diskless workstation to give its own IP address.

C

- Communication Communication has four components: sender, receiver, message, and medium. In networks, devices and application tasks & processes communicate messages to each other over media. They represent the senders and receivers. The data they send is the message. The cabling or transmission method they use is the medium.
- Connection In networking, two devices establish a connection to communicate with each other.

D

DHCP Dynamic Host Configuration Protocol was developed by Microsoft and is a protocol for assigning dynamic IP addresses to devices on a network. With dynamic addressing, a device can have a different IP address every time it connects to the network. In some systems, the device's IP address can even change while it is still connected. DHCP also supports a mix of static and dynamic IP addresses. This simplifies the task for network administrators because the software keeps track of IP addresses rather than requiring an administrator to manage the task. This means a new computer can be added to a network without the hassle of manually assigning it a unique IP address. DHCP allows the specification for the service provided by a router, gateway, or other network device that automatically assigns an IP address to any device that requests one

DNS Domain Name System is an Internet service that translates domain names into IP addresses. Since domain names are alphabetic, they're easier to remember. The Internet however, is really based on IP addresses. Every time you use a domain name, the DNS will translate the name into the corresponding IP address. For example, the domain name `www.network_camera.com` might translate to `192.167.222.8`.

E

Enterprise network An enterprise network consists of collections of networks connected to each other over a geographically dispersed area. The enterprise network serves the needs of a widely distributed company and operates the company's mission-critical applications.

Ethernet The most popular LAN communication technology. There are a variety of types of Ethernet, including 10 Mbps (traditional Ethernet), 100 Mbps (Fast Ethernet), and 1,000 Mbps (Gigabit Ethernet). Most Ethernet networks use Category 5 cabling to carry information, in the form of electrical signals, between devices. Ethernet is an implementation of CSMA/CD that operates in a bus or star topology.

F

Fast Ethernet Fast Ethernet, also called 100BASE-T, operates at 10Mbps or 100Mbps over UTP, STP, or fiber-optic media.

Firewall A firewall is considered the first line of defense in protecting private information. For better security, data can be encrypted. A firewall is a system designed to prevent unauthorized access to or from a private network. Firewalls are frequently used to prevent unauthorized Internet users from accessing private networks connected to the Internet, especially Intranets. All messages entering or leaving the intranet pass through the firewall, which examines each message and blocks those that do not meet the specified security criteria.

G

Gateway A gateway links computers that use different data formats together.

Group	Groups consist of several user machines that have similar characteristics, such as being in the same department.
H	
HEX	Short for hexadecimal, “HEX” refers to the base-16 number system, which consists of 16 unique symbols: the numbers 0 to 9 and the letters A through F. For example, the decimal number 15 is represented as F in the hexadecimal numbering system. The hexadecimal system is useful because it can represent every byte (8 bits) as two consecutive hexadecimal digits. It is easier for humans to read hexadecimal numbers than binary numbers.
I	
IEEE	Institute of Electrical and Electronic Engineers.
Intranet	This is a private network, inside an organization or company, that uses the same software you will find on the public Internet. The only difference is that an Intranet is for internal usage only.
Internet	The Internet is a globally linked system of computers that are logically connected, based on the Internet Protocol (IP). The Internet provides different ways to access private and public information worldwide.
Internet address	To participate in Internet communications and on Internet Protocol-based networks, a node must have an Internet address that identifies it to the other nodes. All Internet addresses are IP addresses.
IP	The Internet Protocol is the standard that describes the layout of the basic unit of information on the Internet (the packet) and also details the numerical addressing format used to route the information. Your Internet service provider controls the IP address of any device it connects to the Internet. The IP addresses in your network must conform to IP addressing rules. In smaller LANs, most people will allow the DHCP function of a router or gateway to assign the IP addresses on internal networks.
IP address	An IP address is a 32-bit binary digit number that identifies each sender or receiver of information that is sent in packets across the Internet. For example, 80.80.80.69 is an IP address. It is the closest thing the Internet has to telephone numbers. When you “call” that number, using any connection method, you get connected to the computer that “owns” that IP address.
ISP	Internet Service Provider. A company that maintains a network that is linked to the Internet by way of a dedicated communication line. An ISP offers the use of its dedicated communication lines to companies or individuals who can’t afford the high monthly cost for a direct connection.

J

JAVA Java is a programming language that is specially designed for writing programs that can be safely downloaded to your computer through the Internet without the fear of viruses. It is an object-oriented multi-thread programming best for creating applets and applications for the Internet, Intranet and other complex, distributed networks.

L

LAN Local Area Network. A computer network that spans a relatively small area sharing common resources. Most LANs are confined to a single building or group of buildings.

N

NAT Network Address Translator. Generally applied by a router, a network address translator makes many different IP addresses on an internal network appear to the Internet as a single address. For routing messages properly within your network, each device requires a unique IP address. But the addresses may not be valid outside your network. NAT solves the problem. When devices within your network request information from the Internet, the requests are forwarded to the Internet under the router's IP address. NAT distributes the responses to the proper IP addresses within your network.

Network A network consists of a collection of two or more devices, people, or components that communicate with each other over physical or virtual media. The most common types of networks are LANs and WANs. In a LAN (local area network), computers are in close distance to one another. They are usually in the same office space, room, or building. In a WAN (wide area network), the computers are in different geographic locations and are connected by telephone lines or radio waves.

N-Way Protocol A network protocol that can automatically negotiate the highest possible transmission speed between two devices.

P

PING Packet Internet Groper. A utility used to determine whether a specific IP address is accessible. It functions by sending a packet to the specified address and waits for a reply. It is primarily used to troubleshoot Internet connections.

PPPoE Point-to-Point Protocol over Ethernet. PPPoE is a specification for connecting the users on an Ethernet to the Internet through a common broadband medium, such as a DSL or cable modem. All the users over the Ethernet share a common connection.

Protocol	Communication on the network is governed by sets of rules called protocols. Protocols provide the guidelines devices use to communicate with each other, and thus they have different functions. Some protocols are responsible for formatting and presenting data that will be transferred from file server memory to the file server's network adapter. Others are responsible for filtering information between networks and forwarding data to its destination. Still other protocols dictate how data is transferred across the medium, and how servers respond to workstation requests and vice versa. Common network protocols responsible for the presentation and formatting of data for a network operating system are the Internetwork Packet Exchange (IPX) protocol or the Internet Protocol (IP). Protocols that dictate the format of data for transfers the medium include token-passing and Carrier Sense Multiple Access with Collision Detection (CSMA/CD), implemented as token-ring, ARCNET, FDDI, or Ethernet. The Router Information Protocol (RIP), a part of the Transmission Control Protocol/Internet Protocol (TCP/IP) suite, forwards packets from one network to another using the same network protocol.
R	
RARP	Reverse Address Resolution Protocol. A TCP/IP protocol that allows a physical address, such as an Ethernet address, to be translated into an IP address.
RJ-45	RJ-45 connectors are used for Ethernet cable connections.
Router	A router is the network software or hardware entity charged with routing packets between networks.
S	
Server	A server is a simple computer that provides resources, such as files or other information.
SMTP	The Simple Mail Transfer Protocol is used for Internet mail.
SNMP	Simple Network Management Protocol. SNMP was designed to provide a common foundation for managing network devices.
Station	In LANs, a station consists of a device that can communicate data on the network. In FDDI, a station includes both physical nodes and addressable logical devices. Workstations, single-attach stations, dual-attach stations, and concentrators are FDDI stations.
Subnet mask	In TCP/IP, the bits used to create the subnet are called the subnet mask.
T	
TCP/IP	Transmission Control Protocol/Internet Protocol is a widely used transport protocol that connects diverse computers of various transmission methods. It was developed to connect different computer types and led to the development of the Internet.

Transceiver A transceiver joins two network segments together. Transceivers can also be used to join a segment that uses one medium to a segment that uses a different medium. On a 10BASE-5 network, the transceiver connects the network adapter or other network device to the medium. Transceivers also can be used on 10BASE-2 or 10BASE-T networks to attach devices with AUI ports.

U

UDP The User Datagram Protocol is a connectionless protocol that resides above IP in the TCP/IP suite

ULP The upper-layer protocol refers to Application Layer protocols such as FTP, SNMP, and SMTP.

User Name The USERNAME is the unique name assigned to each person who has access to the LAN.

Utility It is a program that performs a specific task.

UTP Unshielded twisted-pair. UTP is a form of cable used by all access methods. It consists of several pairs of wires enclosed in an unshielded sheath.

W

WAN Wide-Area Network. A wide-area network consists of groups of interconnected computers that are separated by a wide distance and communicate with each other via common carrier telecommunication techniques.

Windows Windows is a graphical user interface for workstations that use DOS.

Workgroup A workgroup is a group of users who are physically located together and connected to the same LAN, or a group of users who are scattered throughout an organization but are logically connected by work and are connected to the same network group.

Workstations Workstation refers to the intelligent computer on the user's desktop. This computer may be an Intel-based PC, a Macintosh, or a UNIX-based workstation. The workstation is any intelligent device a user works from.

Free Manuals Download Website

<http://myh66.com>

<http://usermanuals.us>

<http://www.somanuals.com>

<http://www.4manuals.cc>

<http://www.manual-lib.com>

<http://www.404manual.com>

<http://www.luxmanual.com>

<http://aubethermostatmanual.com>

Golf course search by state

<http://golfingnear.com>

Email search by domain

<http://emailbydomain.com>

Auto manuals search

<http://auto.somanuals.com>

TV manuals search

<http://tv.somanuals.com>