

## Category 3 Safety laser scanner

### Two zone programmable area control

#### FEATURES

- No touch detection system in compliance with the requirements of IEC/EN 61496 part 1 and pr EN 61496 part 3 for Type 3 equipments
- Meets applicable parts of ANSI B11.19-1990 standard and OSHA 1910.212 regulations for Control Reliability
- Objects and people protection
- Surveillance area size up to 262 m<sup>2</sup> / 2820 ft<sup>2</sup>
- Class 1 infrared Laser beam, invisible and harmless to the eye
- Easy to install: a single device, a single cable
- Detection of a unique inner failure per EN 954-1
- Fast and accurate configuration of the surveillance areas around the dangerous zone with a computer and user friendly software
- The shape of the protection zones fits any environment (Teach-in option for zone definition)
- Scanning angle: up to 300°
- Free rotating head, making it a self-cleaning optical system
- Permanent self-checking of the beam status with fixed test target
- External user defined test target possibility to ensure correct positioning of the laser during machine operation
- Response time: 0.280 s
- Surveillance range: 10 m / 32.8 ft
- Detection range: 6 m / 19.7 ft
- Resolution: 70 mm / 2.8 in at 6 m / 19.7 ft

#### TYPICAL APPLICATIONS

- Horizontal detection (like a sensitive mat) of people or objects
- Anti-collision system for AGVs



(Pending)

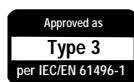

The FF-SE laser scanner from Honeywell is a revolutionary product in the world of industrial safety. This device combines radar and laser principles to scan pre-defined zones around dangerous machinery or moving vehicles. In case of intrusion in these zones, output relays are immediately opened, eliminating the danger.

An infrared class 1 laser beam strikes a mirror rotating at 8 Hz, allowing it to sweep a 300° area. Any object with a minimum reflectivity of 1,8% (black target) will be detected in a 6 m / 19.7 ft radius. Two safety levels may be set through two zones that can have any shape:

- “alarm zone”, in a 10 m / 32.8 ft radius around the FF-SE
- “safety zone” in a 6 m / 19.7 ft radius

These two zones are defined using the software (ordered separately), running on a computer connected to the FF-SE, which allows the areas to be protected to be displayed on the screen. The two zones correspond to two independent outputs, allowing multiple applications:

- the alarm zone can be used to trigger an acoustic or light signal when a person approaches, which indicates that there is a close danger, allowing the intruder to withdraw without stopping the machine.
- the safety zone is used to trigger the immediate stopping of the machinery (2 safety NO contacts).

Restart is automatic after clearing the zone. Use additional safety control module if manual restart is needed.

This system is unique because of its small resolution (0,5° in angle) and its excellent precision, while covering a wide area (262 m<sup>2</sup> / 2820 ft<sup>2</sup>). The FF-SE has been designed in agreement with the pr EN 61496-3 that will soon be brought into effect for this new kind of detecting device.

External and internal surveillance systems make it a Type 3 optoelectronic protective system. Its self-cleaning optical head and its good immunity to pollution guarantee a superior reliability.

#### **WARNING**

##### MISUSE OF DOCUMENTATION

- The information presented in this product sheet (or catalogue) is for reference only. DO NOT USE this document as system installation information.
- Complete installation, operation and maintenance information is provided in the instructions supplied with each product.

**Failure to comply with these instructions could result in death or serious injury.**

## FF-SE

- Objects and people protection
- Scanning angle up to 300°
- Surveillance up to 262 m<sup>2</sup> / 2820 ft<sup>2</sup>



BIA  
Berufsgenossenschaftliches  
Institut für  
Arbeitssicherheit

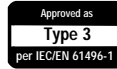

Dimensions in millimeters / inches, meters / feet, weights in kg / lbs

Features	Power supply	24 Vdc, ± 15%
	Consumption	0,75 A at 24 Vdc, rush at startup: 2 A during 100 ms
Measure and detection angle		300°
Detection distance		Black target (1,8%): 6 m / 19.7 ft
Outputs		3 relay outputs, free of potential: 2 A / 48 V
Head spinning frequency		8 Hz, ± 5%
Status display		Green: safety zone free • Red: safety zone occupied • Yellow: alarm zone occupied - Diagnostic
Emitting source		Infrared laser LED, 905 nm, ± 30 nm
Beam divergence		0,9°
Interface		RS 232, V.24, 19200 Baud
Safety class		Sensor: Type 3 according to IEC/EN 61496-1 <sup>(1)</sup> • Laser: Class 1 <sup>(2)</sup> according to IEC 825-1
Protection class		IP 65 (NEMA 4, 13)
Operating temperature		0 °C to 50 °C / 32 °F to 122 °F
Storage temperature		-20 °C to 70 °C / -4 °F to 158 °F
Shock and vibration resistance		According to IEC 68
Material		Casing: Aluminium • Connector: Steel
Colour		Yellow paint RAL 1021

### Ordering information

FF-SEEDGE6G2-1 Sensor kit  
(Sensor + power cable)  
and  
FF-SEZ6SOFT2 Software kit (Diskette + PC cable)

### Accessories:

FF-SEZ6BRAC3 Mounting bracket  
FF-SEZ6PLAT Mounting plate  
FF-SEZ6POST Post supporting the bracket

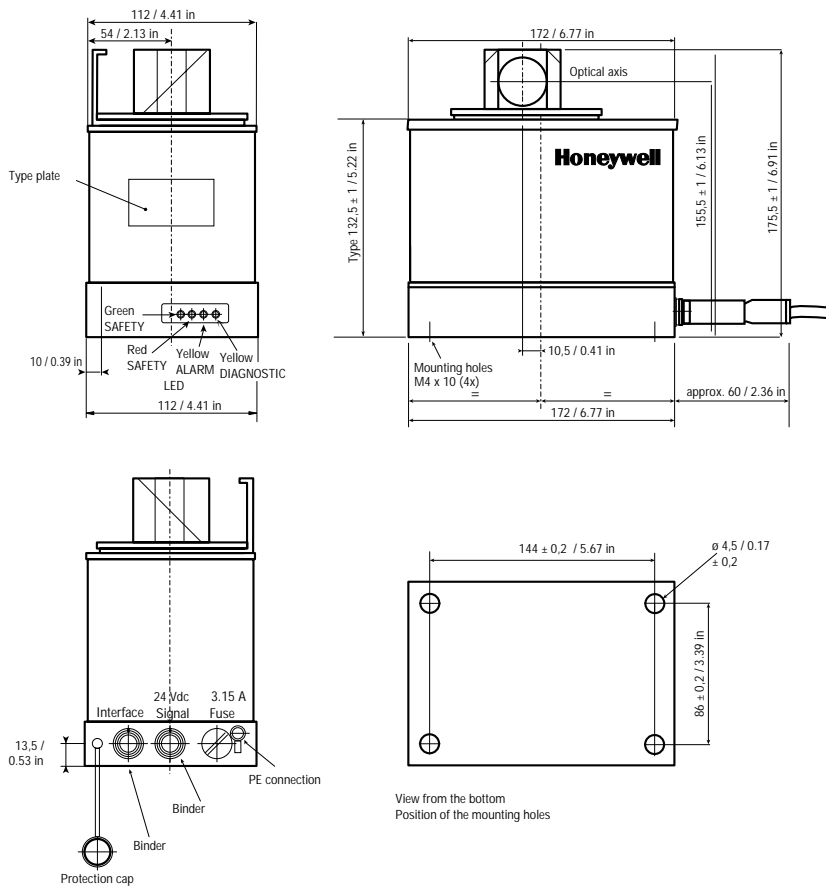

### Remarks

(1) Category 3 per EN 954-1.

(2) No special limitation of use in the USA or in Europe.

Infrared beam radius		At 6 m / 19.7 ft: 100 mm / 3.9 in • At 10 m / 32.8 ft: 170 mm / 6.7 in
Beam Increment		0,5°
Response time	t1	280 ms (including relays)
Device weight		3 kg / 6.61 lbs

FF-SE

## Tolerance and detection distances

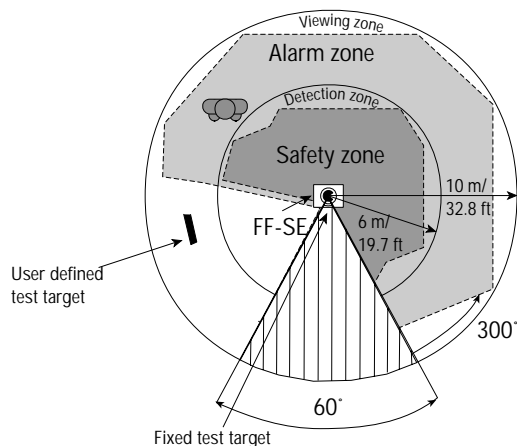

## Installation distance

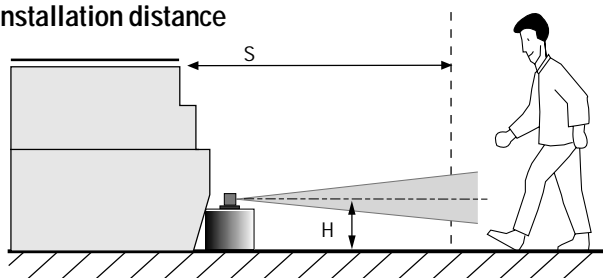

$$S \geq V (t_1 + t_2) + (L - 0.4 H) + E$$

Where:

- *S*: Distance (mm / in)
- *t1*: Response time of the FF-SE (See technical specifications)
- *t2*: Stopping time of the machine (s); i.e. the time interval necessary to stop the machine, after the protection device has emitted the stop signal
- *L*: 1200 mm / 47.28 in
- *H*: Height of the beam from the ground,  $300 \leq H \leq 1000 \text{ mm} / 11.82 \leq H \leq 39.4 \text{ in}$
- *V*: Penetration velocity (mm / s or in / s) ( $V = 1600 \text{ mm / s in Europe}$ )  $V = 63 \text{ in / s in USA}$
- *E*: Maximum Error in measurement (see technical specifications)

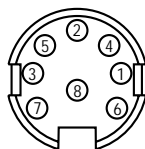

Pin number	Signal	Function
1	24 V	Power 24 Vdc supply
2	GND24	Ground 0 Vdc supply
3 SAFETY 2.1	DETEC2	Safety 2 relay output
4 SAFETY 2.2	DETEC2	Safety 2 relay output
5 SAFETY 1.1	DETEC1	Safety 1 relay output
6 SAFETY 1.2	DETEC1	Safety 1 relay output
7 ALARM1		ALARM relay output
8 ALARM2		ALARM relay output
SHIELD	PE	Protection earth

The protection zone is made up of 600 beams. Each beam receives a signal corresponding to a distance measured using the light time of flight principle, whatever the reflectivity of the target. If this signal goes below a user defined threshold during the surveillance, it means that an object is present in the protection area. Consequently, the corresponding relay is opened.

The surveillance area includes an alarm zone and a safety zone, that are user-defined. Both may have an irregular shape which corresponds to the environment.

## Applications: a greater flexibility

The FF-SE being an optoelectronic detecting device, it has a no touch detection and therefore brings more flexibility on site. Its principle of diffuse reflection simplifies the installation, compared to the traditional emitter/receiver pair of light curtains. The protection zones do not need any additional fixture (wall, fence, door...) since the FF-SE covers a 300° angle and adapts to existing obstacles. Installation costs are reduced to a minimum and the working position is easily accessible since the protection is a no-touch type.

In case of a change in the machine or production floor layout, the FF-SE can adapt very quickly by a re-configuration. The FF-SE is not linked to any particular set up or machine: it is exchangeable just by programming.

Compared to a usual safety device (light curtain, safety mat, door...), the FF-SE includes two protection zones which is a great asset: the alarm zone, used as an early warning zone, allows a signal to an intruder that he is close to a dangerous zone and that his movement is about to stop the machine. There is still time for the individual to change direction and avoid a stoppage of the equipment that can be costly if it occurs often. By avoiding unnecessary stoppage, the FF-SE increases the production lines productivity without decreasing the safety: it protects just what is needed.

## Computer connection

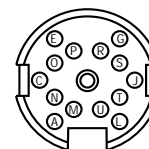

RS232

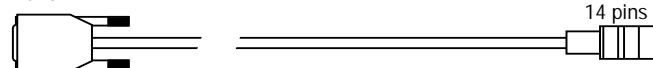

PC RS232

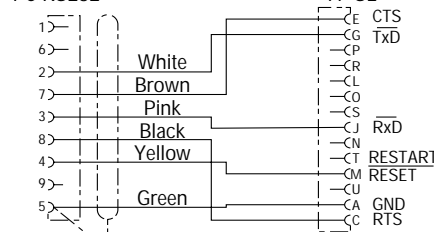

## Software

The Honeywell software kit allows the protection zones to be easily programmed into the sensor. This software runs under any PC (286 or more), under MS DOS. The FF-SE is linked to the PC through the serial port (RS232 format) and a cable supplied with the software kit. The custom zone definition can be achieved through 3 different methods that can be combined:

- with the mouse, by clicking on end points forming the limit of the protection field;
- with the keyboard, by plotting points with the cursor keys;
- with a text editor in which the end points are defined by their coordinates;

Defining the protection zones is easy since obstacles are displayed on the screen: they are seen in real time.

Using a PC also allows to store several configurations on a disk, that can be retrieved in a few seconds into the sensor. One can therefore define different shapes according to different situations and transmit them into the sensor whenever needed.

Once the settings are downloaded into the sensor, it is a standalone device that will keep all zone definitions and parameters in a permanent memory, even if the power is cut. Access to this memory and to zone definition is protected by a password. The program also has other features: real time profile measurement, sensor simulation to get familiar with it, surveillance of the zones with intrusion time display.

## Self-check

A fixed test target is mounted on top of the housing to ensure the beam self-check: this takes away 60° off the scanning angle to perform various checks: contamination of the lens, accuracy of the distance measurements, status of the beam...

An external test target possibility ensures the correct positioning of the sensor and guarantees the safety if its position is changed since the definition of the zones depend on the position of the sensor. The rotating head is self-cleaning and therefore is much less sensitive to pollution as other fixed-window devices. The internal angular coder is controlled by a "surveillance circuitry", as are the relays.

## Graphic screen

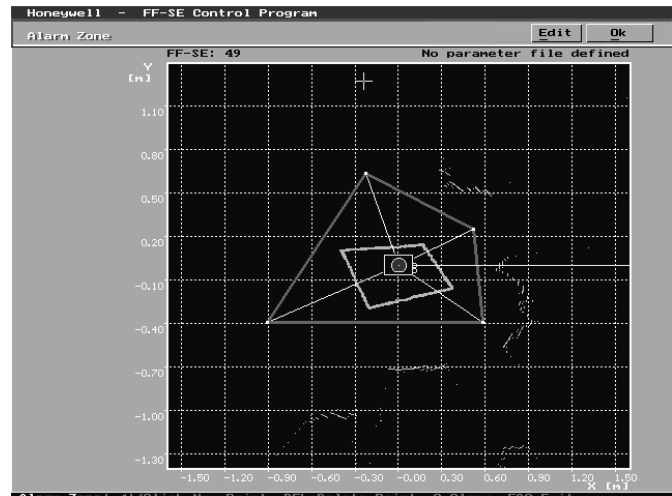

## Defining the zones with the editor

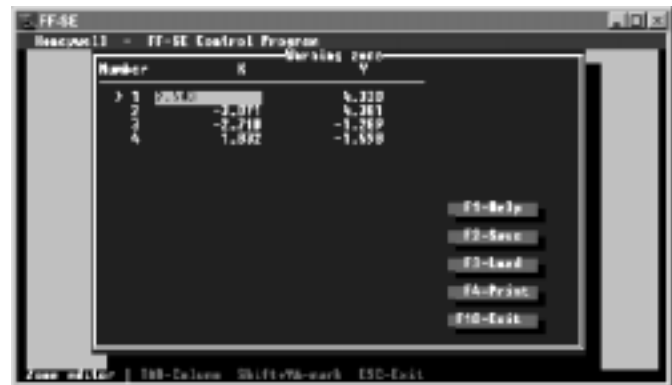

## Example of electrical connection

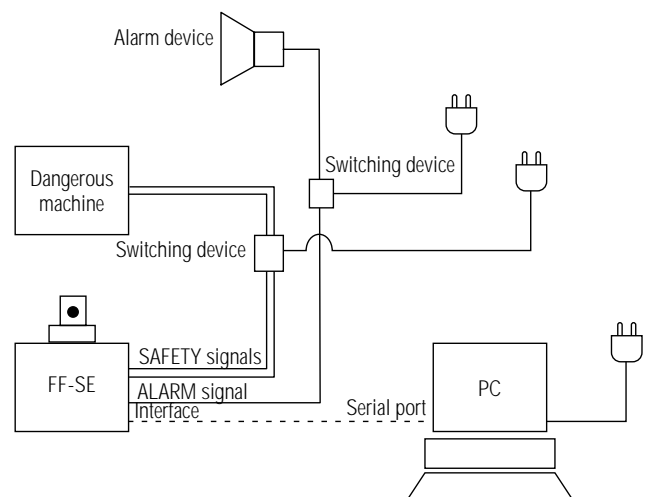

Connection diagram

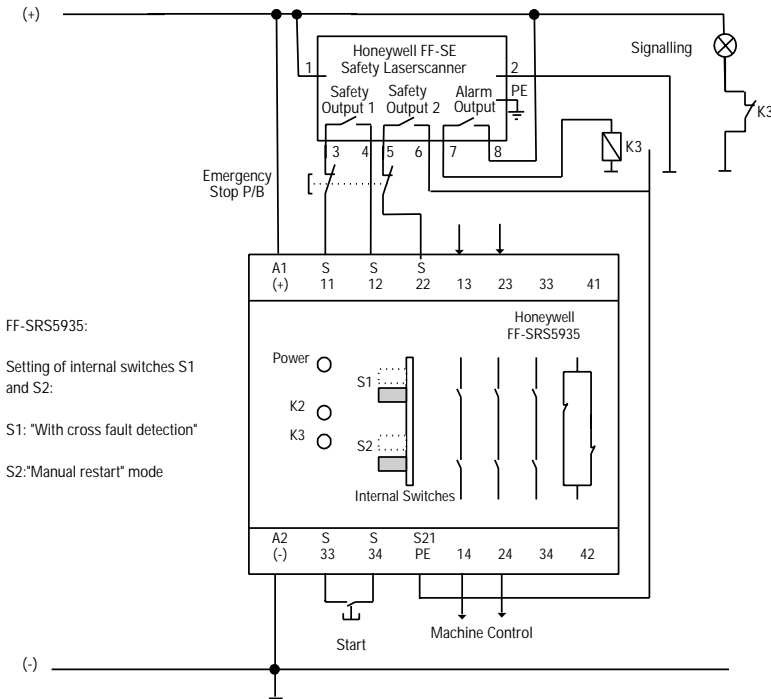

Installation

The FF-SE can be installed in various configurations. It does not need any receiver nor separated reflector. When mounted horizontally, it replaces light curtains or safety mats by offering a better coverage and an increased flexibility. Its small size allows installations in most of existing sites. The laser beam is an invisible Class 1 laser, therefore it is not harmful and does not disturb workers. A unique connector links the sensor to the power supply and the devices connected to the 3 output relays (alarm, safe 1 and safe 2), making connections with the sensor very easy.

For AGVs

Weight and speed of AGVs in industrial environments can represent a certain danger for the workforce. The FF-SE can be installed on these AGVs to ensure people safety: due to its long range, it can stop the AGV before the obstacle, even if its speed is high.

The two distinct zones can be used in an elegant way:

The alarm zone, with its 10 m / 32.8 ft range, acts as a slowing down system: if something is detected in the zone, the AGV will slow down and emit a warning signal to make the way free again.

The safety zone, with its 6 m / 19.7 ft range, acts as an emergency stop: the AGV will immediately be stopped when an object is detected in this zone.

Knowing the AGV stopping distance and the response time of the safety chain, it is possible to calculate the limits of these zones optimally.

Minimum distance

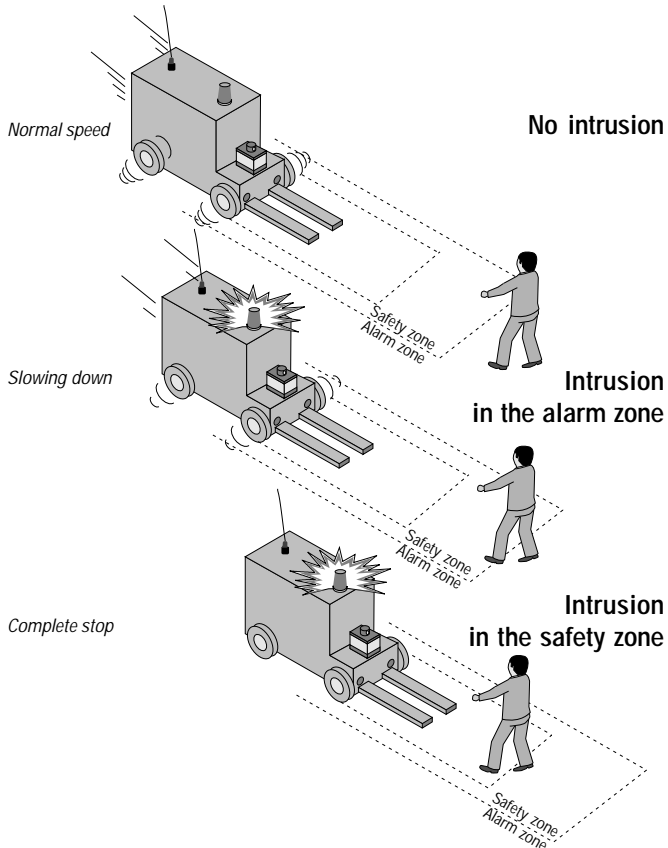
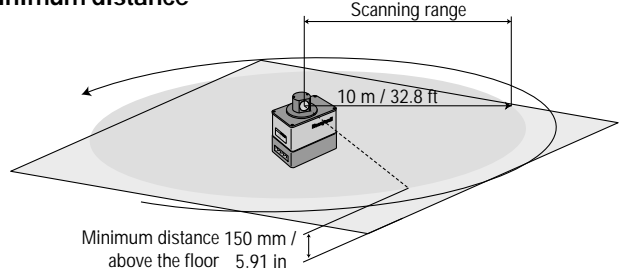

## Accessories

- FF-SEZ6BRAC3 Mounting bracket:** It reinforces the protection in installations where the sensor could be reached by humans or vehicles. It allows head up or down mounting. The bracket can be mounted on a vertical surface from behind thanks to 4 M6 holes. There are 2 adjustable screws that allow an adjustment of the scanning plane ( $\pm 8^\circ$ ) in X,  $\pm 4^\circ$  in Y, so as to allow an accurate placement of the beam, especially in multiple device configurations.



### Dimensions in millimeter/inches

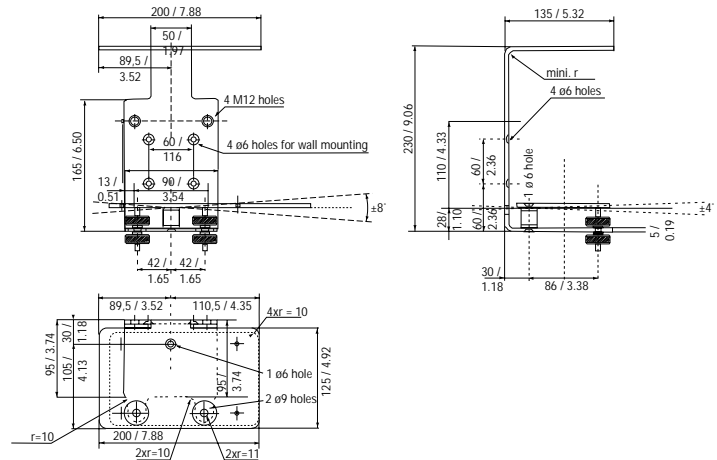

- FF-SEZ6PLAT Mounting plate:** Mounting plate to mount the scanner on horizontal ground.

- FF-SEZ6POST:**

This post is designed to support the mounting bracket FF-SEZ6BRAC3. This allows an adjustment of the scanning plane height. The scanning plane can be adjusted from 300 mm up to 700 mm / 11.82 in to 27.58 in. The bracket can also be rotated around the post. A collar holds the bracket to the post and slides on the post. The bracket can be mounted up or down, so that the laser scanner head is either up or down.

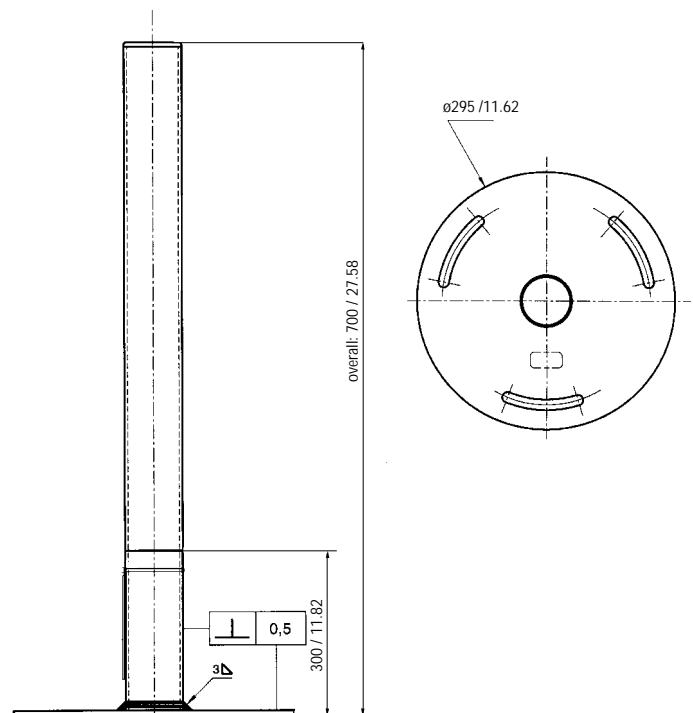
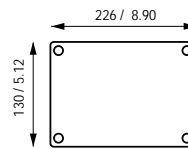
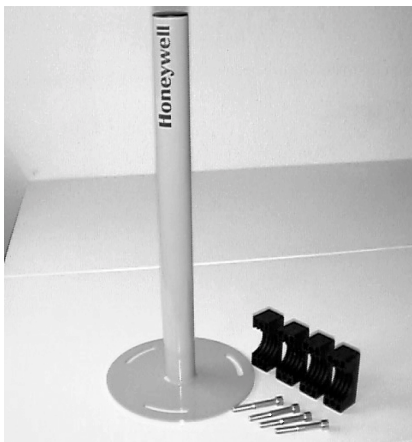

- FF-SEZ6SOFT2:** The Honeywell software kit allows sensor programming and setup. It is supplied with a manual explaining how to use it and an RS232 cable for PC connection.

## Free Manuals Download Website

<http://myh66.com>

<http://usermanuals.us>

<http://www.somanuals.com>

<http://www.4manuals.cc>

<http://www.manual-lib.com>

<http://www.404manual.com>

<http://www.luxmanual.com>

<http://aubethermostatmanual.com>

Golf course search by state

<http://golfingnear.com>

Email search by domain

<http://emailbydomain.com>

Auto manuals search

<http://auto.somanuals.com>

TV manuals search

<http://tv.somanuals.com>