



# Technical Overview For Mark III Communications Management Unit (CMU)

23 July 2002



# 1 INTRODUCTION

## 1.1 Mark III CMU Overview

Honeywell provides a family of Datalink products, ranging from the AFIS product for the business Jet market, to our Mark II and Mark III CMUs for the Air transport and Military market. The Mark III Communications Management Unit (CMU), discussed in this document, is Honeywell's High-End "Next Generation" CMU. The Mark III is a fully functional ARINC 758 CMU built using the latest hardware and software technology, making it the most powerful and capable CMU in the industry today. Designed to exceed today's stringent datalink requirements, the Mark III offers the capability to grow for tomorrow's rapidly expanding datalink requirements.

The Mark III CMU is the next generation in CMU products. It offers over 100 Mbytes of memory (64 MB of volatile memory and 48 MB of non-volatile memory). Utilizing a Pentium 266 MHz processor and 2 Power PC dedicated I/O processors, the Mark III also offers a significant increase in processing power over other CMUs in the industry. The dedicated I/O processors ensure the elimination of throughput bottlenecks allowing the Mark III to concurrently process data from all data sources (today and in the future).

The Mark III CMU is a full ARINC 758 complaint unit, and is supported by an Aircraft Personality Module (APM). In addition, the Mark III CMU contains additional I/O capability above and beyond that called out for in the ARINC 758 characteristic. This includes a UHF Modem added to the unit for potential future use of UHF as a datalink subnetwork. It includes customized RS 422 ports to support non-ARINC 739 CDUs that are used on such aircraft as Embraer 135/145, and includes a PCMCIA interface for rapid dataloading. In addition, the Mark III CMU has specifically been designed to support future modifications outside of the ARINC 758 specification, to enable implementation of new technology that will provide additional benefits to our airline customers. This expansion would be introduced using the current spare card slots designed into the unit. The primary upgrade being planned is the introduction of an integrated Gatelink capability into the unit, which would allow airlines to grow the CMU to support very high speed / short range communication while on the ground using a 2.4 Ghz spread spectrum<sup>1</sup> technology.

The baseline Mark III CMU provides the capability to communicate over HF DL, SATCOM, and VHF (Mode O/A). By designing the Mark III CMU with the necessary hardware to support future datalink requirements, functionality like VDL Mode 2 and the Aeronautical Telecommunications Network (ATN) are added with just a software upgrade. Due to the size of the memory and processor capability contained within the unit, the Mark III CMU provides the lowest risk to an airline for introduction of such new technology, as it becomes required for future CNS/ATM operation.

The Mark III CMU utilizes a database-driven software architecture, which provides unparalleled flexibility. All I/O parameters for an entire aircraft fleet are captured in a Flexible Input Data Base (FIDB). The Mark III CMU then determines the aircraft type from the Aircraft Personality Module (APM) and applies the appropriate set of I/O signals for that aircraft type.

A user has the capability to customize their Airline Operational Communications (AOC) application through the use of the Airline Modifiable Information (AMI) database. All of the I/O parameters specified in the FIDB are available to the user as part of the AMI definition. By having the I/O parameters isolated to the FIDB, a single AMI can be subsequently generated using logical I/O parameters for all aircraft types within a fleet. The AMI allows the user to:

- Design the screen layouts

---

<sup>1</sup> The integrated Gatelink approach would provide on the order of a 1 to 11 Mbit/second network over approximately 1,000 feet utilizing the unlicensed 2.4 Ghz spread spectrum frequency. The Gatelink upgrade would also require a TWLU and antennas to be installed on the aircraft, in addition to a hardware upgrade to the Mark III CMU.

- Define uplink and downlink message formats
- Define the format of printed messages
- Specify trigger logic (i.e., OOOI)
- Define the geographic area for specific frequency coverage
- Define the subnetwork preference by region
- Capture exceedances (mini-ACMS capability)

Once a user generates a new AMI, implementation is as simple as generating a disk containing the new AMI database and using the Mark III CMU dataload capability to load the AMI into each aircraft with no certification effort required.

The Mark III CMU also incorporates a new concept called the Honeywell Generated Information (HGI) database. The HGI is a controlled database that contains protected information used by applications. Typically, the HGI will contain protocol timers, ATC screen and printer formats, and ATC message definitions. As with the AMI, all aircraft I/O parameters from the FIDB are available for use by the HGI. Although changes to the HGI require a certification effort, no embedded operational software changes are required.

Both the AMI and the HGI are generated using a common tool called the Ground Based Software Tool (GBST). The GBST is a Windows-based application that allows the user to perform normal windowing functions such as cutting and pasting components between the various GBST screens. The GBST is based on the B-777 GBST, providing the same type of user interface as for the B-777, but providing increased functionality available in the Mark III CMU.

## 1.2 Datalink Capability for Today and Tomorrow

Today, datalink users have found that datalink is an indispensable tool for helping manage operations, maintenance and other functions. Datalink provides access to more data and timely data which results in time and cost savings for an airline. Datalink users have found that datalink:

- Improves accuracy and efficiency of communicating with the flight crew
- Improves information dissemination within airline operations
- Provides timely availability of information
- Reduces delay times
- Reduces airline personnel effort (i.e., data courier, special services)
- Improves operational performance
- Reduces fuel costs
- Improves maintenance operation
- Improves passenger service
- Reduces pilot workload

The rapid expansion of datalink requirements has stretched the existing ACARS network toward capacity and has accelerated the desire of datalink users to move away from the limited ACARS Management Unit (MU) to the more capable Communications Management Unit (CMU).

The industry is demanding new approaches to meet the new requirements. Timely and accurate information exchange between the aircraft and the ground is critical to an airline's operation. Digital datalink communications provides a method of moving that information to the right place at the right time, saving both

time and money. However, to deliver the future datalink capability required by the airlines, both ground and airborne systems must have a transition to the next generation architecture.

The Mark III CMU offers a datalink user the next generation ARINC 758 CMU capable of providing the datalink functionality to meet the industry demands for today and tomorrow.

### **1.3 Honeywell Datalink Experience, Products, and Services**

Honeywell has been developing Datalink Management Units since the early 1980s starting with the ARINC 597 ACARS. Since that time, Honeywell has continuously evolved and introduced new systems, comprised of the 724 ACARS (introduced in 1988), the Mark I 724B ACARS (introduced in 1989), and the Mark II User Re-programmable ACARS (introduced in 1991).

Honeywell currently offers two go-forward CMU products. The Mark II CMU is offered for 724B or 758 wiring installations. The 965-0758-001 PN is for 724B installations, while the 965-0758-002 is for ARINC 758 installations. The other CMU is our new Mark III CMU (PN 7519200-920), which is offered for ARINC 758 wiring solutions<sup>2</sup>, and is described in this document.

Honeywell is the leading supplier of datalink systems, with over 100-datalink customers. This is significant in light of the fact that at the beginning of the 1990s, Honeywell had only three customers. We contribute this large growth due to the fact that we have continued to invest in datalink systems and technology. The new Mark III is the latest in such product introductions.

Honeywell also developed the equivalent of an ACARS MU for the Boeing 777. This was the first dual and integrated ACARS system and the first essential ACARS system.

Airbus uses a communications unit named the Air Traffic Services Unit (ATSU) which is designed and manufactured by Aerospatiale. The ATSU is a Supplier Furnished Equipment (SFE) system but the AOC applications software is provided as Buyer Furnished Equipment (BFE). Honeywell is the leading supplier of ATSU AOC software, which is based on the same AOC software contained in the highly successful Mark II CMU.

With our offering for the B-777, the ATSU and our CMU, Honeywell is the only manufacturer that can support all three aircraft configurations.

Honeywell is also a leading supplier of datalink display systems. Whether it is a full-sized ARINC 739 MCDU, a compact ARINC 739 Multi-Input Display Unit (MIDU) or a compact CDU, there is a datalink display system for all aircraft from air transport and regional to business jet and general aviation.

The Mark III interfaces with many avionics devices, particularly Flight Management (FM) systems. Honeywell is the leading supplier of FMs, whether it is the advanced Pegasus platform in the air transport arena or the NZ-2000 in the regional and business jet market. Honeywell also provides FM systems in its integrated avionics solutions (AIMS, VIA, and Epic).

To complete a user's datalink capability, Honeywell also offers ARINC 740 cockpit printers, SATCOM, and radio systems (HF and VHF).

In addition to datalink products, Honeywell offers supporting services. The Honeywell Global Data Center (GDC) provides ground-based data services for users that do not wish to implement their own ground infrastructure. GDC currently provides a turnkey solution for over 2,200 datalink equipped aircraft. This

---

<sup>2</sup> The 7519200-920 part number reflects the standard Mark III CMU designed for ARINC 758 for air transport aircraft.

includes such services as Providing world-wide Weather messages to the aircraft, as well as being an FAA approved distributor of messages such as Pre-Departure Clearances and ATIS. The Honeywell Aircraft Maintenance and Operational Support System (AMOSS) provides ground ACARS message processing and integration with flight planning systems. Finally, Honeywell provides world class product support worldwide.

## 2 SYSTEM OVERVIEW

### 2.1 Hardware Overview

The Mark III CMU is based upon the Multiple Application Processing System (MAPS) platform which is the new generation hardware that will be used for introduction of new Honeywell datalink products. This common hardware platform will facilitate the introduction of communication products that integrate new capabilities with the Mark III CMU.

The Mark III CMU is a single Line Replaceable Unit (LRU) housed in a standard 4 MCU ARINC 600 form factor. The Mark III CMU contains 4 Circuit Card Assemblies (CCAs): (1) Processor; (2) I/O; (3) Power Supply; and (4) Interconnect. There is expansion capacity for two spare CCAs.

The main processor is a 266 MHz Pentium while the I/O is handled by two MPC 860 microprocessors. These two I/O processors are able to concurrently process all I/O effectively eliminating throughput bottlenecks. Additionally, there are two dedicated digital signal processors (DSPs), one each for the VHF and UHF modems. There is a total of 64 MB of DRAM along with 48 MB of Flash EPROM.

The front panel of the Mark III CMU (see Figure 1) contains a "PUSH TO TEST" button for initiating Test Mode, two LEDs to indicate Test Mode Pass and Fail, an ARINC 615 connector, and a PCMCIA connector. The ARINC 615 connector can be used for a portable data loader, a Debug and Maintenance Terminal

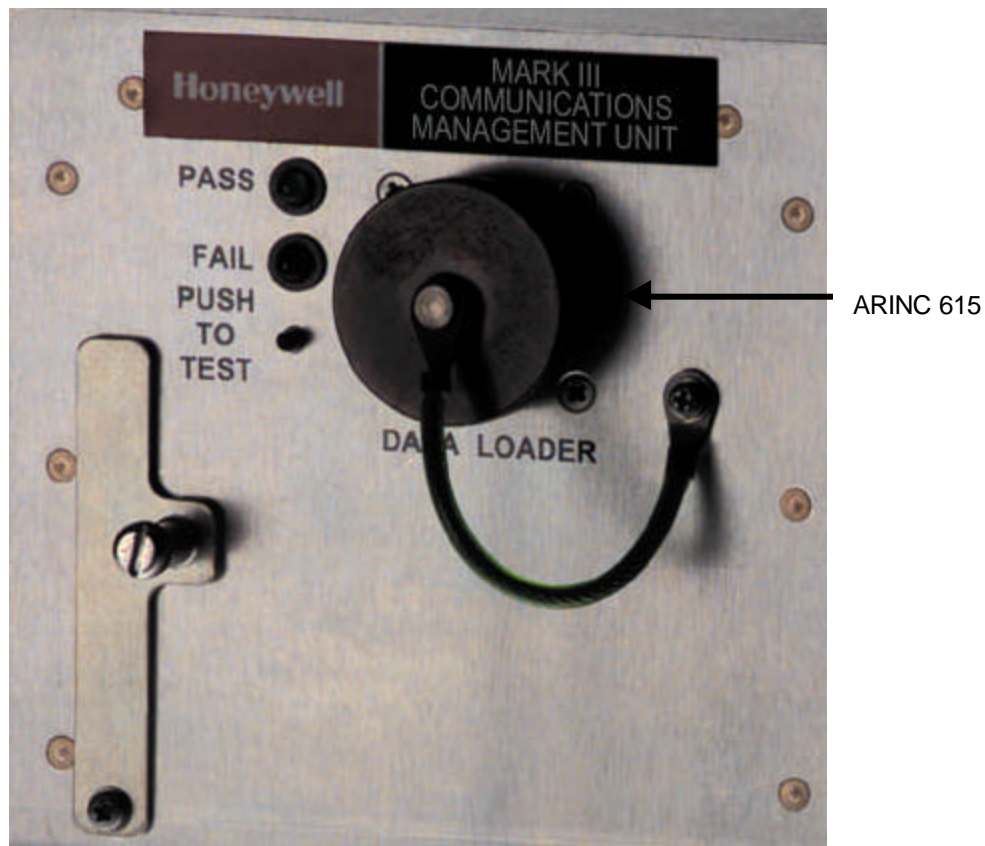

(DMT), or for a Data Logging Terminal (DLT).

**Figure 1 Mark III CMU Front Panel**

ARINC 607 defines the Aircraft Personality Module (APM) which contains all aircraft and system configuration information. The APM is external to the MARK III CMU and is a permanent fixture in the aircraft. Only one APM is required per MARK III CMU installation (one APM for each MARK III CMU mounting tray). The same APM part number is used on all aircraft in the fleet.

**2.2 System Interfaces**

The Mark III CMU supports an extensive set of interfaces. Many of these interfaces are specifically defined by ARINC 758. There are also a number of spare ARINC 429 ports available for additional devices as needed by the user. The Mark III CMU supports all of today's ACARS interfaces used on today's aircraft, with extensive capability for future growth.

**Table 1 Mark III CMU Interfaces**

PCMCIA →

Device	ARINC Specification	Interface	#	Baseline / Growth
VHF Radio	716	Audio	1	Baseline
VDR: Mode 0	750	Audio	1	Baseline
Mode A		High speed ARINC 429	3	Baseline
Mode 2		High speed ARINC 429	3	Option
Satellite Data Unit (SDU)	741	High speed ARINC 429	2	Baseline
	761	High speed ARINC 429	2 (note 1)	Growth
HF Data Radio (HFDR)	753	Low speed ARINC 429	2	Baseline
UHF	---	Audio	1	Growth
Mode S Transponder	718A	High speed ARINC 429	2 (note 7)	Baseline
Gatelink	751	High speed ARINC 429	1	Growth
	undefined	Ethernet 10BaseT	note 2	Growth
MCDU/MIDU	739	High speed ARINC 429	3	Baseline
DCDU	undefined	High speed ARINC 429	1/2 (note 5)	Growth
CDU	----	RS-422	2	Baseline
Printer	740/744	Low speed ARINC 429	1 (note 3)	Baseline (note 3)
	744A	Ethernet 10BaseT	note 2	Growth
FMC	702	Low speed ARINC 429	2/3 (note 4)	Baseline
	702A	High speed ARINC 429	2/3 (note 4)	Growth
Performance Computer (PZ)	----	RS-422	1	Growth
ACMS/DFDAU	619/429	Low speed ARINC 429	1	Baseline
CMC/CFDS/CFDIU	604/624	Low speed ARINC 429	1	Baseline
Cabin Terminal	---	Low speed ARINC 429	2	Baseline
Electronic Library (ELS)	---	High speed ARINC 429	1	Growth
Cockpit Voice Recorder (CVR)	757	Low speed ARINC 429	1	Growth
GPSSU	743	High speed ARINC 429	1	Baseline
APM	607	---	1	Baseline
Dual CMU	758	High speed ARINC 429	1	note 6
Mil-Std-1553B	---	Mil-Std-1553B	1	Growth
DMT	---	RS-232	1	Baseline
DLT	---	RS-232	1	Baseline
Airborne Data Loader	615	High speed ARINC 429	1	Baseline



Portable Data Loader	615	High speed ARINC 429	1	Baseline
Ethernet Data Loader	615A	Ethernet 10BaseT	note 2	Growth
PCMCIA	---	PCMCIA	1	Baseline

Notes:

1. Supports up to 2 total SDUs, whether ARINC 741 or 761.
2. The Mark III provides 4 10BaseT Ethernet ports which can be used for any purpose.
3. Supports 1 ARINC 740/744 printer in baseline. An additional printer can be added to one of the spare ARINC 429 ports. This requires a software upgrade.
4. Supports 3 FMCs in the AT & Mil products.
5. Supports 2 DCUUs in the AT & Mil products and 1 DCU in the BRH product
6. The Baseline Mark III supports Cold Spare operation. A software upgrade would be required for additional dual capability.
7. The Mark II CMU interfaces with the transponder to obtain the ICAO address

### 2.2.1 Subnetwork Interfaces

The Mark III CMU supports a complete set of ARINC 758 subnetwork interfaces (see Figure 2).

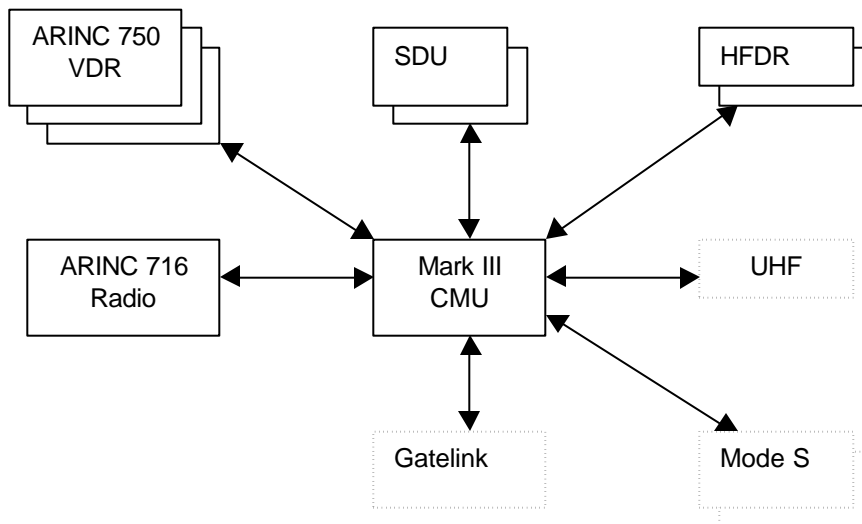

Figure 2 CMU Subnetworks

#### **ARINC 716 VHF Radio**

The Mark III CMU supports an interface with one ARINC 716 VHF radio. The interface supports VDL Mode 0, via an audio line to the Minimum Shift Keying (MSK) modem resident in the Mark III. There is also a low speed ARINC 429 transmit interface between the CMU and the ARINC 716 radio that is used to send frequency tuning information.

#### **ARINC 750 VHF Data Radio (VDR)**

The Mark III CMU can interface with up to three ARINC 750 VDRs. The Mark III supports the operation of a VDR operating in ARINC 716 mode by utilizing the same audio line as used for an ARINC 716 radio. The CMU also supports a high speed ARINC 429 interface to the VDRs for VDL Mode A.

VDL Mode 2 will utilize the same high speed ARINC 429 interface as VDL Mode A, allowing growth to VDL Mode 2 with just a software upgrade. VDL Mode 2 offers an increase of throughput from 2.4 kbps to 31.5 kbps. VDL Mode 2 is necessary both for ATN communications and for ACARS Over AVLC (AOA). VDL mode 2 is offered as an optional software package for the Mark III CMU.

### **Satellite Communications (SATCOM)**

The Mark III CMU can be configured to interface with one or two ARINC 741 compliant Satellite Data Units (SDUs) via low speed ARINC 429, or can be configured for high speed 429.

The industry is still working on the definition of the ARINC 761 specification for second generation satellite communications systems, which will include access to Low Earth Orbit (LEO) and Medium Earth Orbit (MEO) satellite constellations. When datalink communications over ARINC 761 subnetworks is fully defined, it is planned that the Mark III will be updated (software only) to accommodate both ARINC 741 and ARINC 761 satellite communications.

### **HF Data Radio (HFDR)**

The Mark III CMU can be configured to interface with one or two ARINC 753 compliant HFDRs (or HF Data Units -- HFDU) via low speed ARINC 429. The HFDR offers a datalink user another datalink option when line-of-site VHF and satellite communications are not available (i.e., over the ocean or poles).

### **UHF**

The Mark III CMU contains a UHF modem to support UHF datalink. Software support of this interface requires a software upgrade. Currently there are no interfaces used with datalink for UHF, but the hardware has been added into the baseline unit to support potential future capability.

### **Mode S Transponder**

The Mark III CMU can be configured to interface with one or two Mode S Transponders via high speed ARINC 429. Currently, datalink operation over Mode S is not defined. However, the Mark III CMU has the necessary ARINC 429 receivers in place to support such future need, if ever required. It should be noted that the Mark III CMU baseline does include the interface to the Mode S in order to obtain the ICAO 24 character address (which is then used for verification of data in the APM).

### **Gatelink**

The current ARINC 758 specification identifies an ARINC 429 interface for gatelink interfaces. This is supported by the Mark III CMU hardware. However, Ethernet 10BaseT is a more likely Gatelink interface. The Mark III CMU supports up to four 10BaseT Ethernet ports. Honeywell will be offering a future upgrade package to the Mark III CMU that supports Gatelink capability within the unit, interfacing directly with a TWLU (Gatelink - Transceiver Wireless LAN Unit).

## **2.2.2 Flight Deck Devices Interfaces**

The Mark III CMU supports interfaces to the following flight deck devices: (See Figure 2.2.2-1 for the available Datalink display devices supported by the Mark III CMU).

### **Multi-purpose Control and Display Unit (MCDU) / Multi-Input Display Unit (MIDU)**

The Mark III CMU can be configured to interface with up to three ARINC 739 compliant display devices. These devices could be a standard MCDU or the compact MIDU. This is the standard interface on all Boeing / Airbus and many other types of aircraft. The Mark III CMU supports the ability to present different menus simultaneously on different displays, providing a high degree of flexibility to the flight crew.

### **Dedicated Display and Control Unit (DCDU)**

The industry envisions that certain ATS Datalink Services will require a dedicated datalink display device mounted in the primary field of view. The Mark III CMU can be configured to interface with one or two DCDUs via high speed ARINC 429. Software support for these devices is likely to be available through a software-only upgrade once the definition of this interface is fully defined by the industry.

### **Control and Display Unit (CDU)**

In the business jet and regional aircraft market place, there is limited cockpit pedestal real estate. Often, these aircraft are equipped with a 4-line-select key CDU instead of a 6-line-select key MCDU. The Mark III CMU can be configured to interface with one or two of these CDU devices via an RS-422 interface.



MCDU



MIDU



CDU

**Figure 2.2.2-1 Datalink Display Units**

### **Printer**

The Mark III CMU can interface with a single ARINC 740 or 744 compliant printer via low speed ARINC 429. This includes Honeywell's ARINC 740 printer, as well as all other manufacturer's who support the ARINC 740/744 specification.

ARINC 744A defines an Ethernet printer interface. The Mark III CMU has available Ethernet ports but requires a software upgrade to support an ARINC 744A printer. Currently, there are no aircraft configurations defined using the Ethernet interface for the CMU to printer interface.



**Figure 4 Cockpit Printer**

### **Crew Alerts**

The Mark III CMU provides the interfaces necessary to support aural and visual alerts as well as an indication of NO COMM.

## 2.2.3 LRU Interfaces

In general, the Mark III CMU can support any LRU that uses the ARINC 429 File Data Transfer Protocol or Williamsburg Protocol to communicate as an end system, as defined in ARINC 619 (ACARS file transfer protocols for other devices). ARINC 758 identifies a number of specific LRUs and the Mark III CMU supports interfaces to these LRUs:

### **Flight Management Computer (FMC)**

The Mark III CMU can be configured to interface via low speed ARINC 429 with up to three ARINC 702 compliant FMCs operating as end systems. The Mark III CMU can alternatively be configured to interface with up to three ARINC 702A FMCs over high speed ARINC 429. The Mark III CMU can also accept ARINC 429 broadcast data from the FMCs. This broadcast data provides the CMU with data that is captured in the FIDB and available for use by the HGI and AMI.

### **Performance Computer (PZ)**

In some aircraft installations, there is a separate performance computer (PZ) in addition to an FMC. The performance computer communicates with a CDU through the CMU (See Figure 5) via RS-422. The Mark III CMU can support a single interface to a performance computer with a software upgrade.

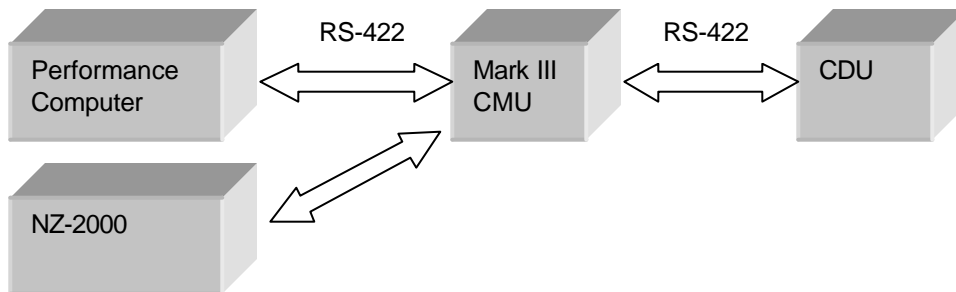

**Figure 5 CMU/PZ Pass Through Interface**

### **Maintenance Computer**

The maintenance computer name varies depending upon the Original Equipment Manufacturer (OEM) but is usually referred to as the Central Maintenance Computer (CMC), Centralized Fault Display System (CFDS), or Central Fault Display Interface Unit (CFDIU). The Mark III CMU can be configured to interface with one maintenance computer over low speed ARINC 429. This interface supports both end system communications as well as the maintenance computer protocol.

The maintenance computer protocol varies based upon airframe. The Boeing 747 uses broadcast fault bits while most other air transport aircraft (e.g., MD-10, MD-11, B-717, A-320, A-330, A-340) use an interactive data block transfer utilizing MCDU screens. Other aircraft types do not currently support maintenance computers (e.g., MD-80, MD-90, B-737, B-757, B767, regional and business jets). The baseline Mark III CMU supports the broadcast fault bits. Interactive data block transfer protocol will be available as a planned upgrade.

### **Aircraft Condition Monitoring System (ACMS)**

The Mark III CMU can be configured to interface with a single Aircraft Condition Monitoring System (ACMS) or Digital Fault Data Acquisition Unit (DFDAU) via low speed ARINC 429. This interface supports end system communications using the standard ARINC 619 protocol in addition to providing the CMU access to

an extensive amount of ARINC 429 broadcast data providing aircraft performance related data. All of the ARINC 429 broadcast data is available via the FIDB to be used by both the HGI and the AMI.

### **Cabin Terminal**

The Mark III CMU can be configured to support up to two Cabin Terminals operating as end systems.

### **Electronic Library System (ELS)**

Although there are no ELS systems in use today which interface to CMUs, the Mark III CMU can be configured in the future to interface with a single ELS operating as an end system via high speed ARINC 429.

### **Cockpit Voice Recorder (CVR)**

The industry is developing ARINC Specification 757 which defines a Cockpit Voice Recorder or Digital Data and Voice Recorder (DDVR) capability. The Mark III CMU provides a single low speed ARINC 429 interface that can be used to interface with an ARINC 757 compliant device. This capability will require a software upgrade.

### **Global Positioning Satellite System Unit (GPSSU)**

The Mark III CMU can accept high speed ARINC 429 broadcast data from ARINC 743 compliant GPSSU(s).

## **2.2.4 Other Interfaces**

The Mark III CMU also supports the following interfaces:

### **Aircraft Personality Module (APM)**

ARINC 607 defines the characteristics of an Aircraft Personality Module which contains aircraft and system configuration information and makes this information available to the CMU. The Mark III CMU supports a single interface to an ARINC 607 compliant APM.

### **Dual CMU**

The Mark III CMU is capable of operating in either a standalone or dual configuration. The Mark III CMU hardware includes interfaces to support dual CMU operation. The interface between the onside and offside CMUs is via a high speed ARINC 429 cross-talk bus along with discretes that indicate active and standby states.

In a dual CMU configuration, the left CMU is normally considered the Active unit and the right CMU is normally considered the Standby unit. The Active CMU is the one that communicates with the subnetworks.

There are three possible dual CMU configurations; cold spare, warm spare, and hot spare.

The Cold Spare Configuration is the configuration in which the two CMUs on the aircraft do not communicate datalink information with each other. In the event of a failure of the Active CMU, the Standby CMU must be manually configured (via a cockpit switch) to be the Active CMU.

The Warm Spare Configuration is the configuration in which the two CMUs exchange datalink information. In the event that a fault occurs in the Active CMU, the Standby CMU will automatically be configured as the Active CMU.

The Hot Spare Configuration is the configuration in which the Standby CMU is monitoring all configuration and traffic so that it can seamlessly assume the role of Active CMU in case of a failure of the Active CMU.

The baseline Mark III CMU supports cold spare operation. Other dual operations are waiting on industry definition. The ARINC Datalink Subcommittee is planning on updating the ARINC 758 characteristic in the

future to define Warm and Hot spare requirements. This effort has not yet started. As the Mark III CMU hardware was designed to support Dual capability, Updated dual capability could be provided with a software upgrade.

#### **Ethernet**

ARINC 646 defines an Ethernet Local Area Network (ELAN) aboard an aircraft. The Mark III CMU provides four 10BaseT Ethernet ports that can be used for various applications which could include Gatelink connectivity, ARINC 615A data loading, ARINC 744A printer and ELAN connectivity. Software support for the Ethernet ports will require a software upgrade.

#### **MIL-STD-1553B**

Mil-Std-1553B is a military standard interface used to communicate with onboard end systems such as an FMC, MCDUs and remote annunciators. This hardware interface is only available in the military version of the Mark III CMU. Software support of this interface requires a software upgrade. This is applicable for only specific Military aircraft.

#### **Debug Maintenance Terminal (DMT) / Data Logging Terminal (DLT)**

A Debug Maintenance Terminal and Debug Logging Terminal can be used to access BITE information, program the APM, and for general debug capability. The Mark III CMU provides two RS-232 ports that can be used for a DMT and a DLT. The RS-232 ports are accessible both from the front and rear connectors and can interface with a laptop computer executing terminal emulation software. The DMT is a device that is used for Honeywell debugging and testing, and is not a device required by our airline customers.

#### **Data Loader**

The Mark III CMU supports an interface to both an ARINC 615 compliant Airborne Data Loader (ADL) and an ARINC 615 compliant Portable Data Loader (PDL) via high speed ARINC 429. The ADL interface is accessible through the rear connector while the PDL is accessible from the front connector.

High speed data loading via PCMCIA and Ethernet are software growth options.

#### **PCMCIA**

The Mark III CMU hardware is equipped with a PCMCIA interface that can be used, to provide a faster means of data loading than an ARINC 615 data loader. The PCMCIA interface is accessible only from the front panel. PCMCIA is Honeywell's recommended method of performing complete full software loads.

#### **OOOI**

The Mark III CMU provides up to 6 high speed ARINC 429 inputs and a number of analog discrete inputs that can be used to determine Out/Off/On/In events. Data available on these interfaces typically include oil pressure, weight on wheels (WOW), flaps, parking brake, and doors.

## **2.3 Software Overview**

In order to meet the system/safety requirements of future CNS/ATM upgrades, all of the Mark III CMU software has been developed to support a future DO-178B Level C. Today, the Mark III CMU is certified to Level D, which is the standard used for certification of ACARS and CMU units. Partitioning in the Mark III CMU is supported by the DEOS operating system which has been previously certified to DO-178B Level A.

The underlying fundamental goal for the Mark III CMU software development was to develop a single software system that could be used with minor modification on other platforms. Honeywell was able to achieve this goal through the use of advanced software development techniques, including model-based development. The model-based approach allowed the developers to design the system independent of the target hardware, capturing the requirements in a model database. The requirements/design are then turned into source code

through an automated code generation system specific to the target environment. Automated test scripts are also derived from the model database. (See Figure 6).

The software architecture was developed to isolate target-specific components from the core software components. The combination of the model-based approach and isolating target-specific components allowed Honeywell to develop a Communications Management Function (CMF) that can be readily hosted on other hardware targets including the Honeywell integrated platforms VIA and Epic (and in the future B-777 AIMS). This common communications function allows Honeywell to maintain a single communications baseline across platforms, ensuring consistent implementations. This is beneficial to an airline that may have a mixed fleet containing both federated and integrated architecture aircraft. A prime example is the Embraer regional jet family. The Honeywell standalone Mark III CMU has been selected by many airlines for their ERJ-135 and ERJ-145 aircraft. The next generation ERJ-170 and ERJ-190 contain the Primus Epic integrated avionics cockpit which includes the CMF. Although the Mark III CMU and the Primus Epic are different hardware platforms, the same core CMF capability exists on both platforms.

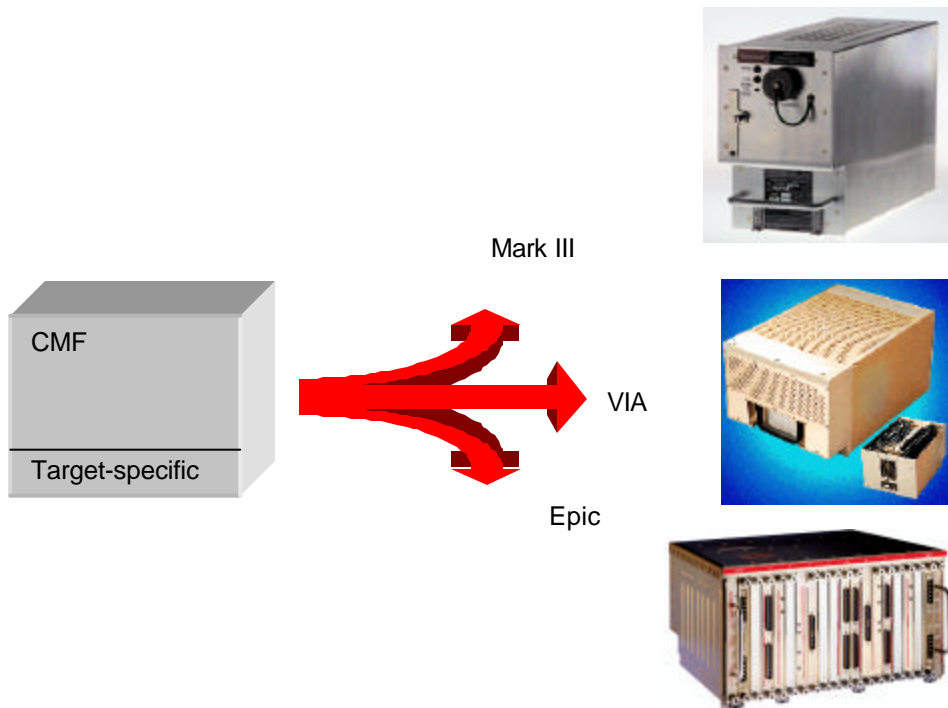

**Figure 6 Communication Management Function (CMF) for Both Federated and Integrated Platforms**

Another driving goal of the software architecture was to provide as flexible a system as possible by utilizing a database-driven design. This design approach allows quick and easy changes to the Mark III CMU without modifying the embedded operational software. (See Figure 7).

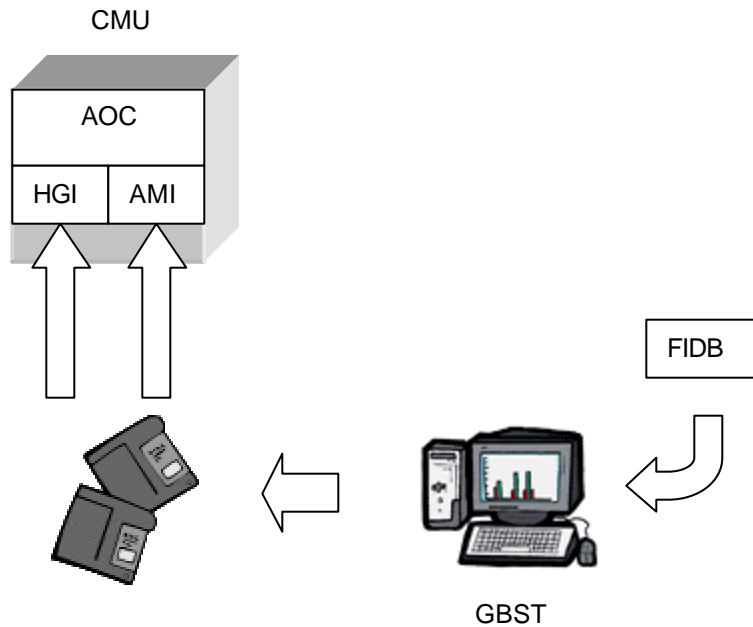

**Figure 7 Database Design**

The Flexible Input Data Base (FIDB) contains a list of all I/O parameters available for all aircraft within a fleet. The FIDB contains information regarding LRU source, data busses, labels, scaling, and resolution for each I/O parameter.

The Airline Modifiable Information (AMI) database is generated by the user to customize their AOC application. AOC screen and print formats, message definitions and trigger logic can all be specified in the AMI. Changes to the AMI only require a dataload operation but no certification activity. This is a significant change from previous systems, such as our Mark II CMU and competitors CMUs, which still maintain much of this processing within an AOC software segment. With the Mark III CMU, all such functionality is contained within the AMI, providing airlines significantly more control and flexibility for performing changes, as requirements change.

The Honeywell Generated Information (HGI) database provides capability similar to the AMI, but for protected data typically used by ATC applications. Unlike the AMI, HGI changes require certification although no change to the embedded operational software.



## 2.4 Certification

Honeywell received the 1<sup>st</sup> FAA certification in December 2001. This initial certification was for Embraer aircraft. The Mark III CMU has since also been type certified by Boeing. Contact Honeywell for up-to-date information on other certifications completed or in work.

### 3 FUNCTIONAL OVERVIEW

The Mark III CMU is designed to provide complete datalink capability, providing interfaces and support to today's installed equipment. In addition, Honeywell as well as the industry recognizes that Datalink features will be expanded over time, and is in fact the principle behind the current ARINC 758 characteristic. A Characteristic that was developed to define current operation (referred to as Level O.1A), and allow expansion over time to support new requirements and needs. The Mark III CMU was specifically designed to support such future growth. Growth Functionality describes potential new capabilities for post-baseline software releases. Many of the capabilities described in both the Baseline Functionality and Growth Functionality sections are configurable via the AMI or the HGI.

The Mark III CMU supports an ARINC 739 MCDU, an ARINC 739 MIDU, and a CDU for displaying ACARS information. For the purpose of simplifying the text of this section, 'datalink display' will be used generically to mean MCDU, MIDU, or CDU.

#### 3.1 Baseline Functionality

The baseline Mark III CMU provides functionality defined as level 0.1A in ARINC 758.

For Reference, the level of functionality as defined in the ARINC 758 Characteristic is shown below. This *level* of functionality is defined, as the CMU is recognized within the industry as evolving over time in order to meet future CNS/ATM requirements.

<b>A758 level</b>	<b>Service Function</b>
0	<b>ARINC 724B ACARS equivalent</b>
	ARINC 618: ACARS
	ARINC 716: VHF
	ARINC 750: VHF Mode 0
	ARINC 741: SATCOM
0.1	<b>+ VDR Mode A using ARINC 429 I/F</b>
	ARINC 750: Mode A
	ARINC 761: SATCOM
	ARINC 753: HF
0.2	<b>AOA VDLM2</b>
1	<b>+ ATN Services</b>
	ARINC 750: VDL Mode 2
2	<b>+ High Speed Services</b>
	Not specified at this time

<b>A758 Level</b>	<b>Application Functions</b>
<b>A</b>	<b>Airline/AOC Applications and ATS Messages</b>
	ACARS End System
	ARINC 620: AOC
	ARINC 620: AAC
	ARINC 623: ATIS
	ARINC 623: PDC
	ARINC 623: Oceanic Clearance
<b>B</b>	<b>+ATS Applications Support and Flight Deck I/F Compatible w/ Non-Radar</b>
	ARINC 622: ACARS Convergence Function (ACF)
	ARINC 622: Air Traffic Facilities Notification (AFN)
	ARINC 745: Automatic Dependent Surveillance - Advanced (ADS-A)
	RTCA/DO219: Controller/Pilot Data Link Communications (CPDLC)/ATS Datalink (ATS DL)
<b>C</b>	<b>+ ATN Application Support &amp; Flight Deck I/F Compatible w/ Radar / Enroute Operations</b>
	ACARS/ATN Gateway
	Context Management (CM)
	Flight Information Services (FIS)
<b>D</b>	<b>+ ATS Applications &amp; Flight Deck I/F Compatible w/ Terminal &amp; Surface Operations</b>
	ATN Systems Management

### **Uplink Processing**

The Mark III CMU can receive uplink messages for routing to other LRUs (e.g., FMC, CMC, ACMS) or for internal processing. Messages can originate from either AOC or ATC ground systems. The Mark III CMU routes messages to an end system based upon the ACARS label and optional sublabel in the message as defined in the routing table. Although there is a default routing table, the user can modify the table via the AMI.

The flight crew will be notified of uplink display messages destined for the Mark III CMU by a visual and potentially an aural alert, depending upon the alert level specified in the uplink message decoding definition. An aural alert is typically a bell or chime while a visual alert is typically an EICAS message.

An uplink display message destined for the Mark III CMU will normally be placed in the new-messages log until selected for viewing by the flight crew. An uplink message could be defined to be placed in the new-messages log and be printed or just be sent to the printer. Uplinks can also result in an automatically downlinked message containing the information requested by the uplink. The action taken for the uplink as well as the screen and print format for the message is dependent upon the message definition specified by the user in the AMI. Further, the display (or print format) of the uplink message can include any aircraft parameters defined in the FIDB and specified in the AMI.

When selected for viewing, a new message may have crew actions required for the message. If crew action is required, associated ACCEPT and REJECT buttons will exist on the datalink display.

Once an AOC message has been viewed by the flight crew (and any required user action has been taken), it can be placed in one of 8 user defined review categories. ATC messages have a separate review category. The flight crew can access messages placed in the review categories at any time.

A useful analogy for ACARS message processing is an email system. When a new email arrives, the user is alerted ("you have mail") and the message goes into an inbox. Once the message is read, the user will typically file the message into one of several email folders. The review categories can be thought of as email folders.

### **Downlink Processing**

The flight crew can create downlink messages to be transmitted to ground systems. As with uplink messages, the definition of the display format and the downlink message format is defined by the user in the AMI. The downlink message can include any aircraft parameters defined in the FIDB and specified in the AMI.

Once all required data is entered on the downlink screen, the SEND prompt becomes active. After selecting the SEND prompt, the message status transitions to SENDING. The flight crew will be notified of successful receipt by the ground when the message status transitions to SENT.

A downlink message is placed in a user-defined queue for transmission to the ground. The user can define the downlink queue based on any number of criteria. For instance, a downlink queue can be defined for a particular message type. By defining different queues for different message types, a user can ensure equitable transmission of different message types.

A user is also able to define the preferred subnetwork (and even service provider) to be used for transmitting a message to the ground. This preference can vary depending upon the current aircraft position. The user can define regions of the world by specifying a series of latitude and longitude coordinates. For a given region, the user can then specify the preferred subnetwork and frequency (See Figure 8 for an example). The baseline subnetworks include VHF (mode 0/A), SATCOM, and HFDL.

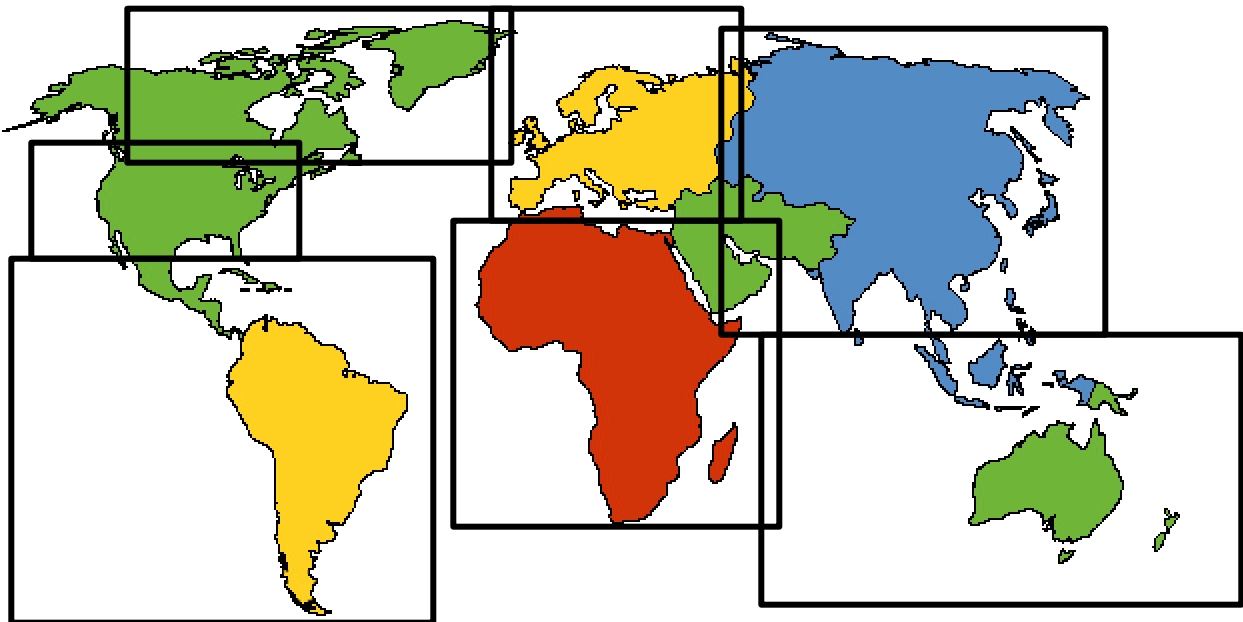

**Figure 8 World Regions**

Once the downlink message has been sent, the message will be placed in the user defined review category specified for the message.

### **System Pages**

The Mark III CMU provides a series of pages that allow users to perform various communications system functions. These system pages allow the flight crew to switch the VHF radios between voice and data and between 8.33 Khz and 25 Khz as well as manually selecting a frequency. The flight crew can also view and override the datalink region definition for the current region.

Some of the system pages support maintenance operations such as viewing/programming the APM, viewing and downloading fault data, and viewing the Mark III CMU part numbers. These pages are not part of the AMI, but rather part of the basic Mark III CMU system.

### **ARINC 623**

The Mark III CMU implements the following ARINC 623 functionality:

- Terminal Weather Information for Pilots (TWIP)
- Air Traffic Information Service (ATIS)
- Pushback Clearance
- Taxi Clearance
- Departure Clearance
- Oceanic Clearance

The screen definitions, uplink and downlink formats and print formats for the ARINC 623 messages are defined in the HGI. This allows for modification to these definitions without changes to the embedded operational software. Since the ARINC 623 messages pertain to ATS communications, there is a certification activity associated with updating the HGI.

### **DMT and DLT**

The Debug and Maintenance Terminal (DMT) provides the capability to access maintenance data, provide debug capability, and test the MARK III CMU. The DMT is used primarily to program the APM, debug, detect, and isolate software and/or hardware failures. In addition, the DMT is used in software and hardware integration, LRU and system integration, formal system testing, and general performance analysis. Access to the DMT function is via one of the RS-232 ports on the front connector which can be easily connected to a laptop computer executing terminal emulation software.

A Data Logging Terminal (DLT) may be used in conjunction with the DMT as a display-only device, keeping the DMT menu screen uncluttered. The DLT function is accessed via one of the RS-232 ports on the front connector. The DMT and DLT are test devices that are not required by the airline customer.

### **BITE**

The following is a list of BITE functions that are performed by the performance monitor and BITE circuitry. The performance monitor can detect internal problems in the LRU, as well as subsystem problems with units connected to the LRU. The BITE coverage for the MARK III CMU is approximately 95% of all circuitry. Faults which are encountered are logged in non-volatile memory, and available for printing or download.

- EPROM Test: Cyclical redundancy check of program code.
- RAM Test: Write/read test of program RAM memory.
- ARINC 429 Receiver/Transmitter Test: A transmitter channel is internally wrapped back to all receiver channels to verify a test transmission is received.
- A/D Converter Test: Verify a test voltage level is correctly encoded.
- Heartbeat Monitor: Reset the microprocessor if programs fail to execute with correct timing.
- Processor Test: Verify processor instruction set, floating point processor and system timers.

- Maintenance Memory Integrity: Verify that faults that are written to the maintenance memory are correctly retained in memory.
- Over-temperature Monitor: Monitor internal LRU temperature and log a fault if normal operational temperature limits are exceeded.
- Interface Tests: Verify physical connections, wiring, and input and output circuitry.
- Network Subsystem Test: Verify availability and status of equipment on networks and busses.

Depending on the severity of the fault and the effect on system performance, the fault may be annunciated to the flight crew as a system failure. Maintenance personnel may extract faults from the unit through several methods:

- The datalink display allows for display and extraction of unit fault storage.
- The front panel LEDs display LRU faults.
- Faults may be downloaded to a Portable Data Loader (PDL) for data analysis.
- Faults may be loaded onto a PC via the Debug and Maintenance Terminal function.

### **APM**

The APM contains information regarding the install status of the various communications links (VHF, UHF, & HF radios, SATCOM, Ethernet, Mode-S) as well as the install status of various external LRUs (FMC, printer, CFDIU, ACMS, CVR, ELS, MCDU/MIDU/CDU).



**Honeywell APM**

The APM is programmable from the datalink display device via the system pages (Note: it is also possible to program via a DMT, but Honeywell is not recommending the DMT as a product the airline operator needs).

### **Data Loading**

The baseline Mark III CMU supports ARINC 615 data loading via the front connector for portable dataloading, through the rear connector for ADL processing or via PCMCIA memory cards through the front of the unit. ARINC 615A (Ethernet) data-loading is planned future enhancements.

## **3.2 Growth Functionality**

### **VDL Mode 2**

Communications over the VHF subnetwork is the most standard method of transmitting datalink messages. It is expected that today's 2.4kbps networks will start to have significant congestion problems in the future, and to avoid this, a new network is being introduced to avoid this problem. This new network being VDL mode 2. It should be noted that the existing network will not become disabled when VDL mode 2 comes on-line, but is expected to remain viable for at least another ten years. There are also other changes that are being proposed for future VHF network enhancements. The following table describes the various progression of VHF datalink modes:

VDL Mode	Modulation	Medium Access	Notes
0	MSK	CSMA	Allows existing MUs to interface with a VDR using the ACARS Subnetwork at 2.4 kbps. The VDR is in effect acting as if it were an ARINC 716 analog radio.
A	MSK	CSMA	Allows CMUs to interface with a VDR using the ACARS VHF Subnetwork at 2.4 kbps. The VDR output to the ground is the old ACARS style, but the VDR interface with the CMU is digital.
2	D8PSK	CSMA	Allows CMUs to interface with a VDR using a digital interface, and adds new protocols within VHF radios and CMUs to support operation over VHF Subnetwork at 31.5

			kbps.
3	D8PSK	TDMS	Same as Mode 2 except the voice is now digitized and the Medium Access changes. Currently. Discussions are underway to determine if Mode 3 will be deployed. This is currently only a U.S. program, with earliest use for datalink scheduled for 2011 (but potentially 4 years earlier for voice)
4	GMSK	STDMA	Modulation and Medium Access change and output is only 19.2 kbps. Mode 4 is being considered as one of the means to perform ADS-B communication. It is currently expected that Mode 4 may not impact CMUs, but this is still to be determined.

The baseline Mark III CMU supports Mode 0 (an analog line to the MSK modem) and Mode A (a W429 link to the radio which has an embedded MSK modem). Mode 2 utilizes a different modulation scheme (D8PSK) allowing a throughput increase from 2.4 kbps to 31.5 kbps. Transition to VDLM2 functionality only requires an operational software upgrade (i.e., no hardware upgrade is required). ). VDL Mode 2 is offered as a separate (optional) software package.

#### **PCMCIA Data Loading**

The Mark III CMU has a PCMCIA connector accessed through the front panel. Utilization of this interface for fast data-loading capability.

#### **Ethernet**

The Mark III CMU is hardware provisioned for up to four 10 Base-T Ethernet ports. These ports can be utilized in the future for a variety of purposes for high speed data communication.

#### **ARINC 761 SATCOM**

As the second generation satellite communications specification (ARINC 761) becomes fully defined, The Mark III CMU hardware is designed to support such future SATCOM systems, with software only changes.

#### **Mil-STD 1553**

The Mark III CMU has an interface to a MIL-STD 1553 bus. Software access to this interface is a potential upgrade to support interfaces on various military aircraft.

#### **Gatelink**

ARINC 751 defines the specification for Gatelink, a wireless LAN interface between the aircraft and the terminal. The Mark III CMU is hardware provisioned to support a Gatelink interface. Honeywell is currently working on additional upgrade modifications (to include large mass memory and new additional circuit card assembly) which would be provided to support a self contained Gatelink capability, with a direct interface to a TWLU.

#### **UHF**

The Mark III CMU has a UHF modem installed as part of the basic Mark III CMU hardware. This has been included such that if UHF becomes a medium that can provide datalink services, such future capability could be implemented without modification to the hardware.

#### **Weather Graphics**

The ability to uplink graphical weather information is an important feature for certain datalink users, particularly in the business jet market. From an industry perspective, there isn't a standard mechanism for delivering graphical weather capability. In addition, weather graphics is currently considered as being cost prohibitive relative to air transport operation. However, Honeywell plans to monitor the industry work in this area and potentially offer a graphical weather capability as a software upgrade. The Mark III CMU does

support as part of the baseline the text Weather uplinks which has become standard use within the Air transport industry.

### **ATN**

The industry has embarked on the definition of a new communications standard named the Aeronautical Telecommunications Network (ATN). The ATN offers a standardized, robust, and efficient communications mechanism that provides additional services. Honeywell has been a leading member of the international consortium, Aeronautical Communication Inc. (ACI) developing this new communications software. The ATN is the ICAO defined solution to be used world wide as the industry transitions much of today's ATC voice communication to datalink in the years ahead.

ACI has developed both the Router Reference Implementation (RRI), which is the communications stack, and the Application Service Elements (ASEs), which are the algorithmic portion of the CNS/ATM-1 applications. ASEs have been developed for Controller Pilot Data Link Communications (CPDLC), Automatic Dependent Surveillance (ADS), Context Management (CM) and Flight Information Services (FIS). ACI developed both the RRI and the ASEs to be portable and therefore readily hostable in a number of different target environments, both in avionics and ground systems. An integrator would only have to port the RRI & ASEs to the target environment and then add the display portion of the applications along with subnetwork-specific interfaces (see Figure 9).

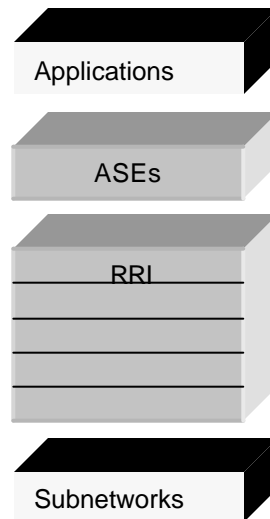

**Figure 9 ATN**

As the only CMU manufacturer involved in the actual development of the ATN software, Honeywell provides our customers with a unique capability of having engineering and technical support as this new technology is fielded in the years ahead. The Mark III CMU was specifically developed to support the addition of this new ATN software, without any hardware modifications to the unit. This will be a future upgrade option for the Mark III CMU.

### **Encryption/Authentication**

Encryption and authentication are key issues surrounding secure data communications. Encryption involves the encoding of the broadcast bit stream using a secure encryption key. Authentication involves ensuring that only authorized users are accessing the application services. The Mark III CMU is designed to support



the addition of encryption algorithms in the future. As part of this work, Honeywell is currently under contract with the U.S. government to define long term concepts for encryption and authentication associated with use in ATN and non-ATN environments.

## 4 DATABASES

Honeywell pioneered the concept of airline reconfiguration and partitioned software for datalink systems in the early 1990s. The reconfiguration concept has continually evolved and improved as each new product has been introduced. Reconfiguration started in the industry with the Honeywell Mark II ACARS unit, and expanded with the B-777 and Mark II CMU. This design concept has continued to be improved resulting in the Mark III CMU being the most flexible and powerful system available today providing unparalleled flexibility in defining the AOC application. In addition, the reconfiguration concept has been expanded to allow support for ATC (Certification related processing). This allows the system to easily be expanded for current and future ATC processing. The architecture for supporting such reconfiguration is centered around the Database design contained with the Mark III CMU. Changes to these databases do not require embedded operational software changes, making changes much simpler and faster (and not prone to software coding errors). Further, like our Mark II CMU, the approach supports the ability of airlines making changes to the AOC database, using a PC-based tool, without impacting the certification of the unit.

There are three primary databases contained with the Mark III CMU. The AMI database defines the airlines AOC functions. This is the database that either Honeywell or the Airline can create, and update at any time, using a PC based tool (GBST). The second database is the HGI database. The HGI is a database similar to the AMI, but contains information that is considered by certification authorities as requiring certification control. As an example, ATC messages and the corresponding MCDU screens are defined in the HGI database. The HGI database is only modifiable by Honeywell, and does require changes to be under certification control. The third database is the FIDB database. This database defines the mapping between external (input) parameters received from other subsystems on the aircraft and the corresponding parameters used within the CMU as well as in the GBST reconfiguration tool. The FIDB database approach provides a significant improvement over other previous reconfiguration systems, by allowing the CMU to have a single database for all aircraft types, with the FIDB defining aircraft differences. With this approach, single database part numbers can be used across an airlines complete fleet of aircraft, rather than separate database part numbers for each fleet type. Further information on these databases and reconfiguration are provided in the following sections.

### 4.1 FIDB

The Flexible Input Data Base (FIDB) is a cornerstone of the Mark III CMU database design. Aircraft parameter data for each aircraft type is captured in mini-FIDBs. All of the mini-FIDBs are collected into a single master FIDB that contains aircraft data for all aircraft types. For a given customer, data for that customer's aircraft types are put into the Customer FIDB. (See Figure 10).

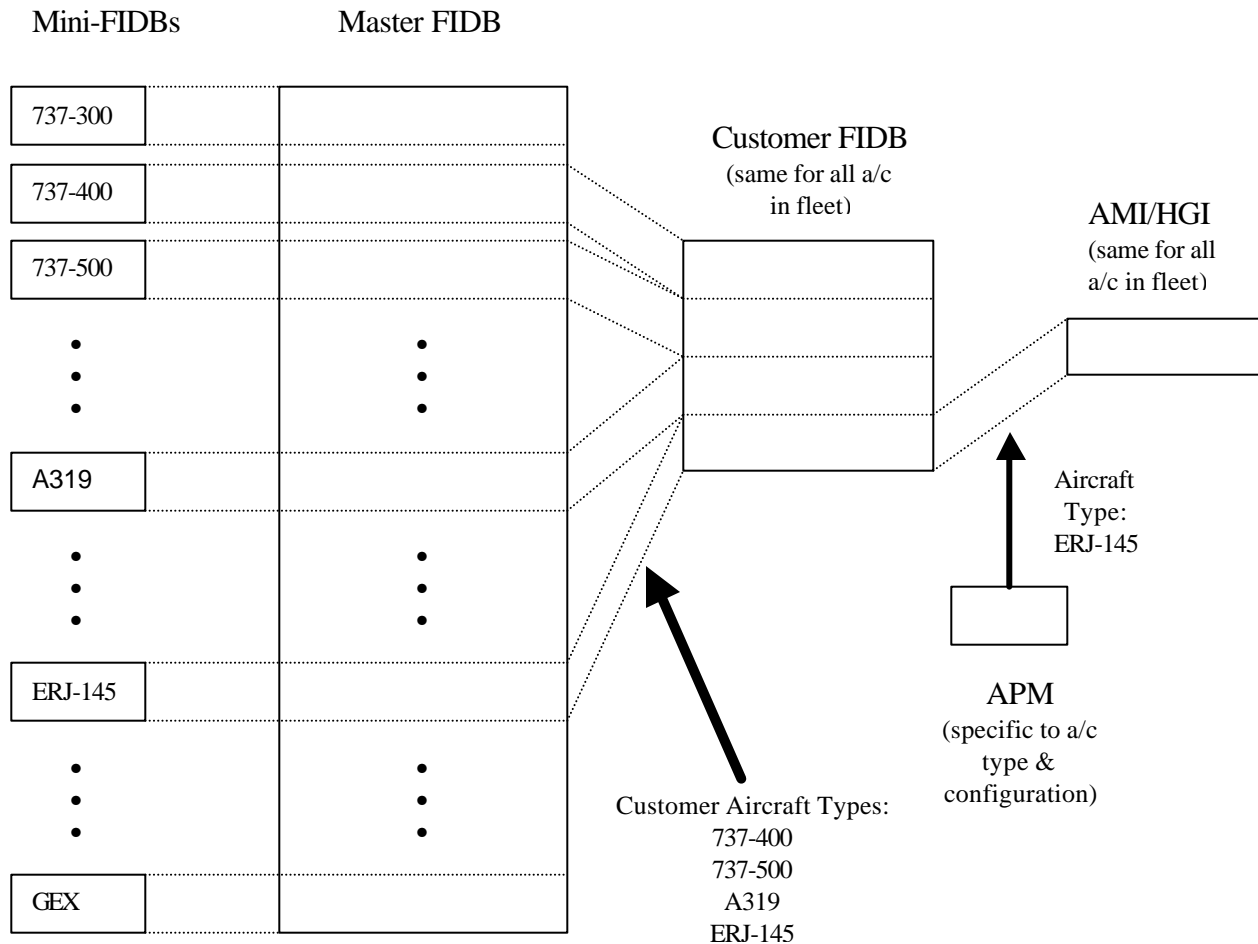

**Figure 10 FIDB Architecture**

The FIDB defines the same name for a given aircraft parameter (i.e., Air\_Speed) regardless of aircraft type. In that way, the HGI and AMI can refer to Air\_Speed without requiring any knowledge of where that data originates (i.e., which bus, which device, etc.). When an AMI or HGI references the data (Air\_Speed), the aircraft type from the APM is used to select the correct data for the given aircraft type. In this manner, a single HGI and AMI can be used across a fleet of aircraft independent of aircraft type.

A FIDB entry fully defines a single aircraft parameter including physical CMU port, bus, data source, data format, resolution, units, scale, offset and data type.

## 4.2 GBST

The Ground Based Software Tool is the single windows-based PC tool that is used to generate AMIs (by the customer) and HGIs (by Honeywell). The FIDB is an input to the GBST and the output is a diskette containing a HGI or AMI that can be data loaded into the Mark III CMU (see Figure 11).

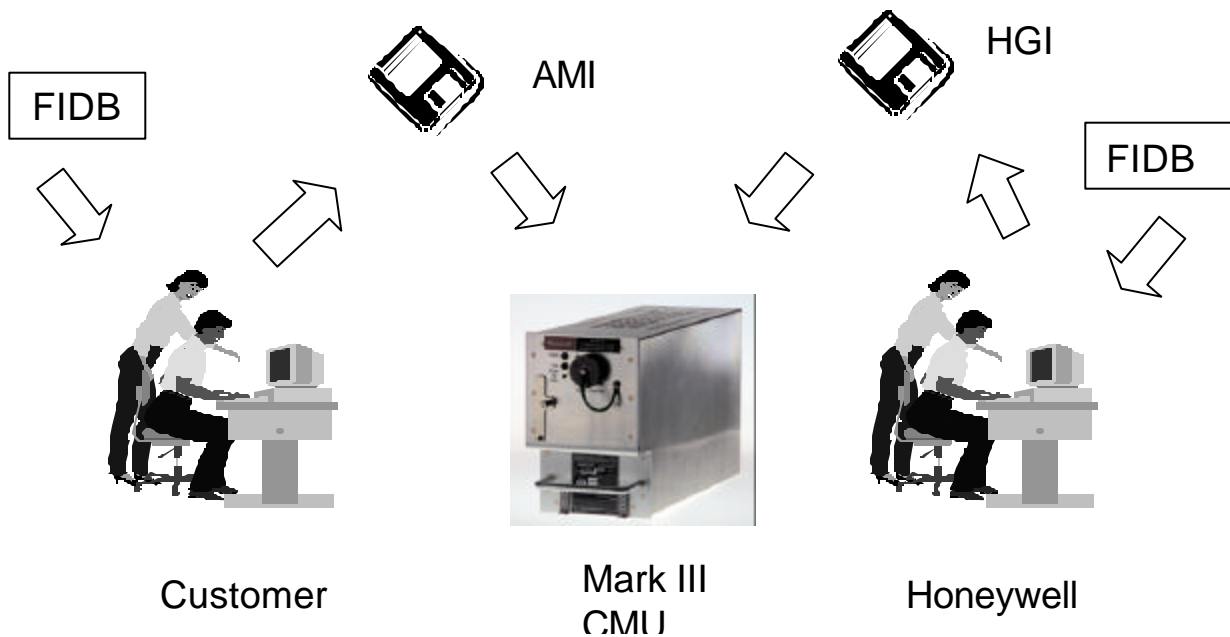

**Figure 11 AMI/HGI Generation**

The GST offers a robust set of capabilities that allow the user to completely customize their AOC application. With the GBST, the user can control the functionality of the CMU, including such major items as:

- defining the datalink menu structure,
- defining the content and characteristics of uplink and downlink messages,
- defining the format of printed messages and screen displays,
- defining user parameters,
- specifying message review categories,
- defining areas and regions of the world to be used for specifying preferred frequencies and subnetworks,
- specifying the set of downlink buffers, and
- generating user-defined algorithms that trigger events when certain conditions are met (such as OOOI algorithms, engine exceedance algorithms, etc).

The GBST provides a wide range of capabilities, and all of the capabilities of the GBST are more than what can easily be described in this product description document. The following sections provides some additional information on how the GBST is used for reconfiguring the Mark III CMU, with the intent of identifying some of the major features of the GBST.

## 4.2.1 Menus

Since the AOC application is completely customizable, the user can define the set of menus that navigate through the various AOC datalink pages. Using the GBST Display Editor, the user types in the text for the menu items, selects the prompt symbol and uses the mouse to move the text next to the line select key to be used to select the menu item. Figure 12 is an example of a main menu screen defined using the GBST Display Editor. With the GBST, each of the AOC screens can be designed / customized to meet the individual needs of each airline.

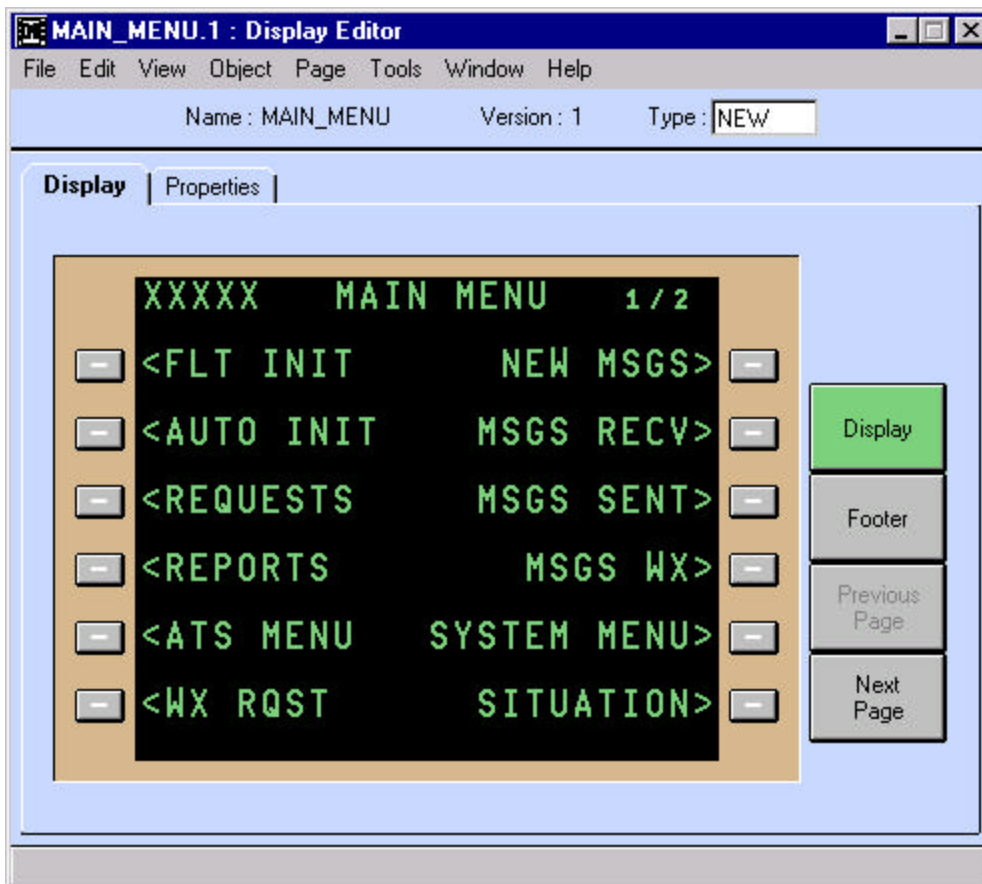

Figure 12 Main Menu

Screens, including menus, can consist of multiple (up to 9) pages. Note the 1/2 in the upper right corner of the Main Menu display indicating page 1 of 2. Pages are accessed by using the Next and Previous page buttons on the display unit. Figure 13 shows page 2 of the example Main Menu.

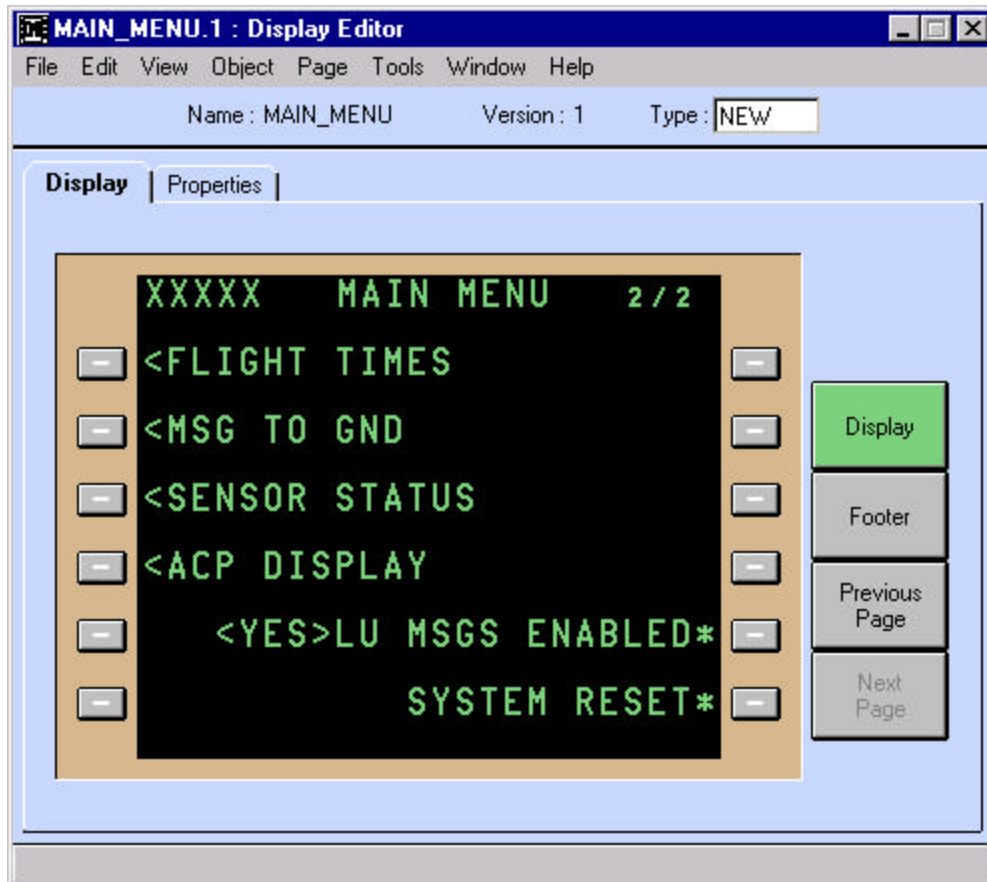

Figure 13 Main Menu Page 2

The GBST supports the screen layouts for both the standard ARINC 739 14 line MCDU/MIDU as well as supporting Honeywell's 9 line CDU (used on various aircraft types such as the Embraer 135/145, and others). Figure 14 shows an example Main Menu on a 9 line CDU.



Figure 14 CDU Main Menu (Supporting Regional / Business Jet CDUs)

This discussion of the GBST and how it is used is equally applicable to both the AMI and the HGI. However, the HGI is only modifiable by Honeywell as it contains controlled data that requires re-certification upon change. There is a baseline HGI for both the 14 line MCDU/MIDU and the 9 line CDU. Therefore, the set of ATS menus and screens will be pre-defined and the user will only need to ensure that there is an ATS prompt on one of the menus (typically the Main Menu) that invokes the ATS menu. Figure 15 depicts an example ATS Menu screen.

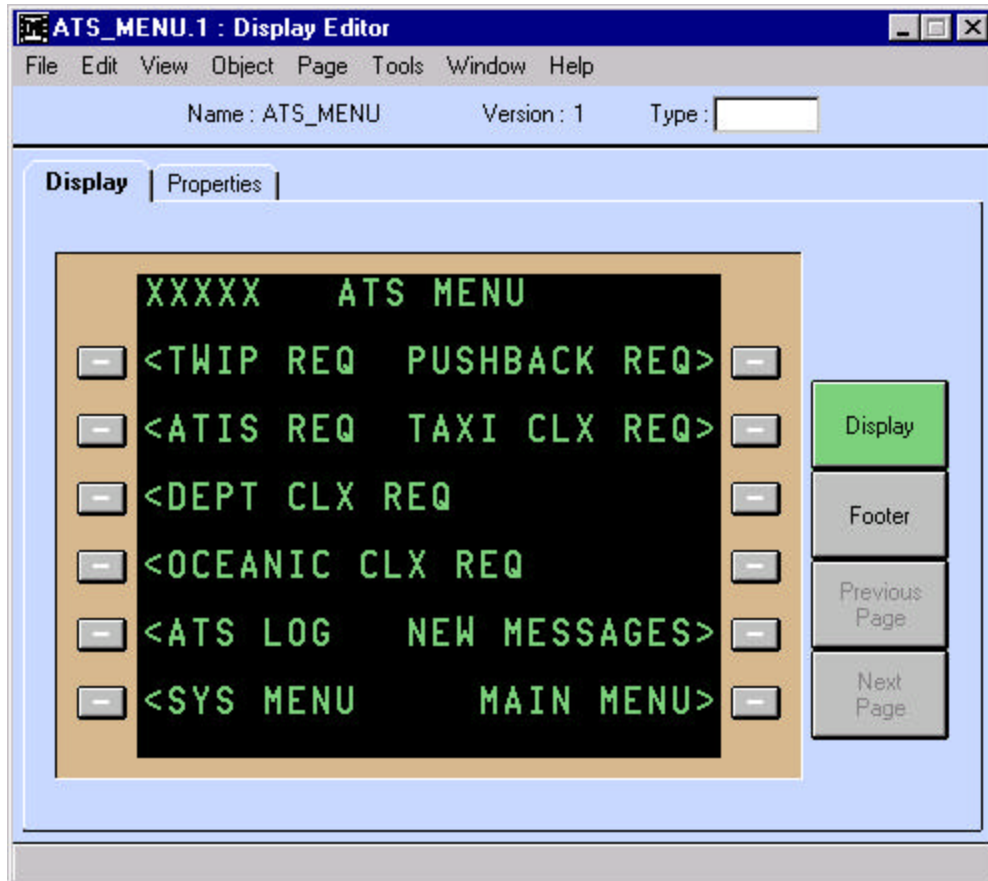

Figure 15 ATS Menu



In addition to the AOC screens defined by the AMI, and ATC screens defined by the HGI, there are additional menus screens within the Mark III CMU, referred to as System screens. The System pages provide the capability to perform various communications management and maintenance functions. These pages are part of the Mark III embedded operational software (not part of the reconfigurable AOC screens). When defining the AMI, the user would also tie in the System pages from one of the menu prompts. Figure 16 depicts an example System Menu.

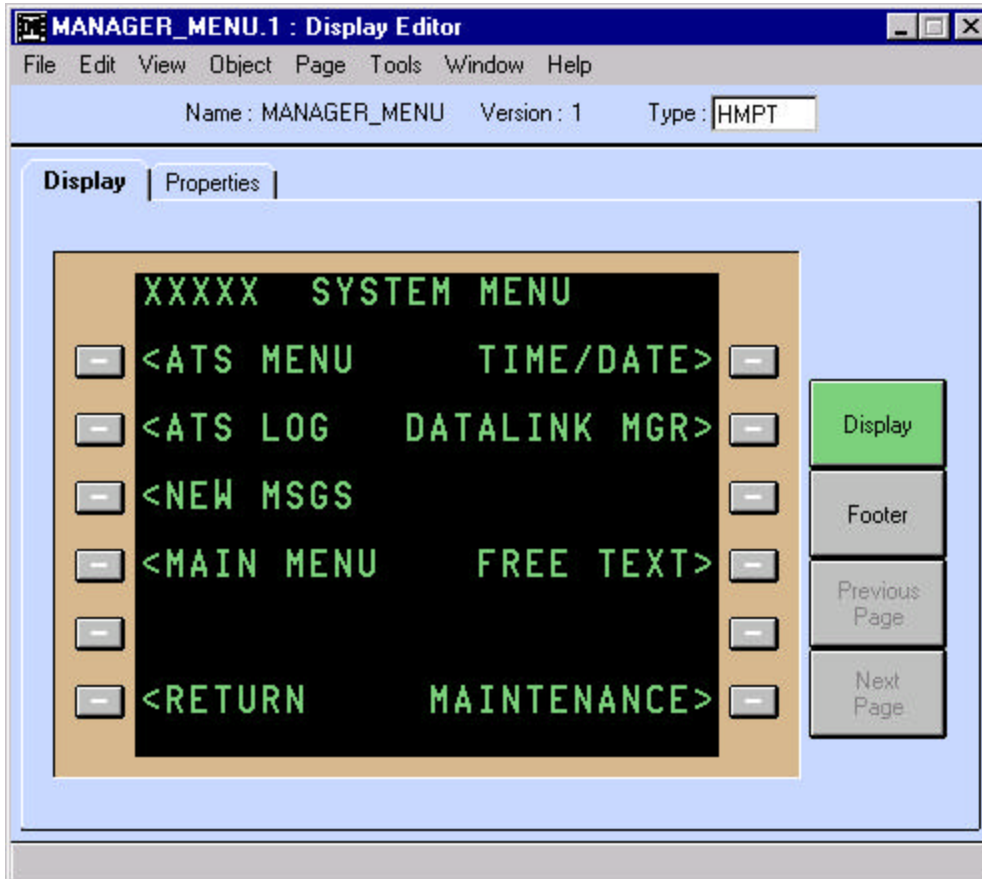

Figure 16 System Menu

## 4.2.2 Uplinks

For uplink messages, the user can define both the screen layout and the uplink message format. Figure 17 depicts an example screen layout for a Clearance Uplink. As part of the display definition, the user specifies the properties of the message display including which review categories this message type should be placed into after initial viewing.

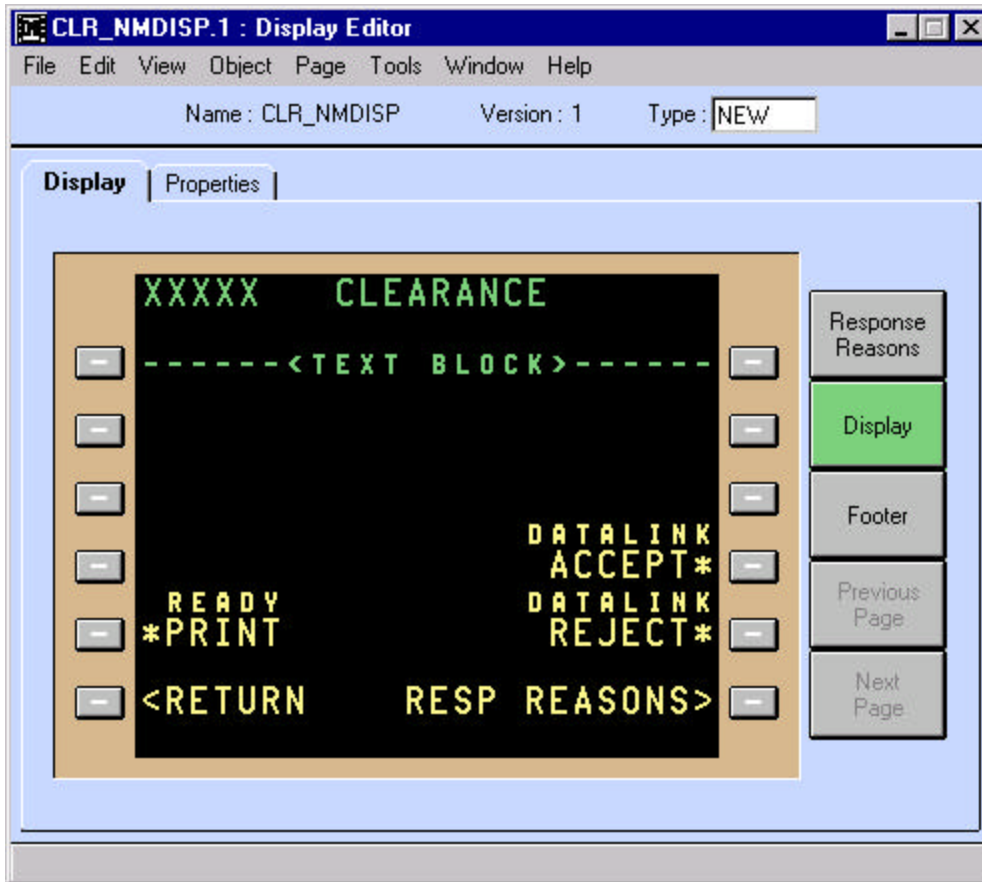

Figure 17 Clearance Uplink

When defining the format and characteristics of an uplink message (i.e., the decoding), the user can specify the elements within the message (see Figure 18), the properties of the message including whether to generate a scratchpad alert and the message references (see Figure 19). The message references specify what level crew alert should be associated with the message, whether the message should be printed upon receipt, whether to automatically send a message upon receipt of this message type, and whether a crew response is required.

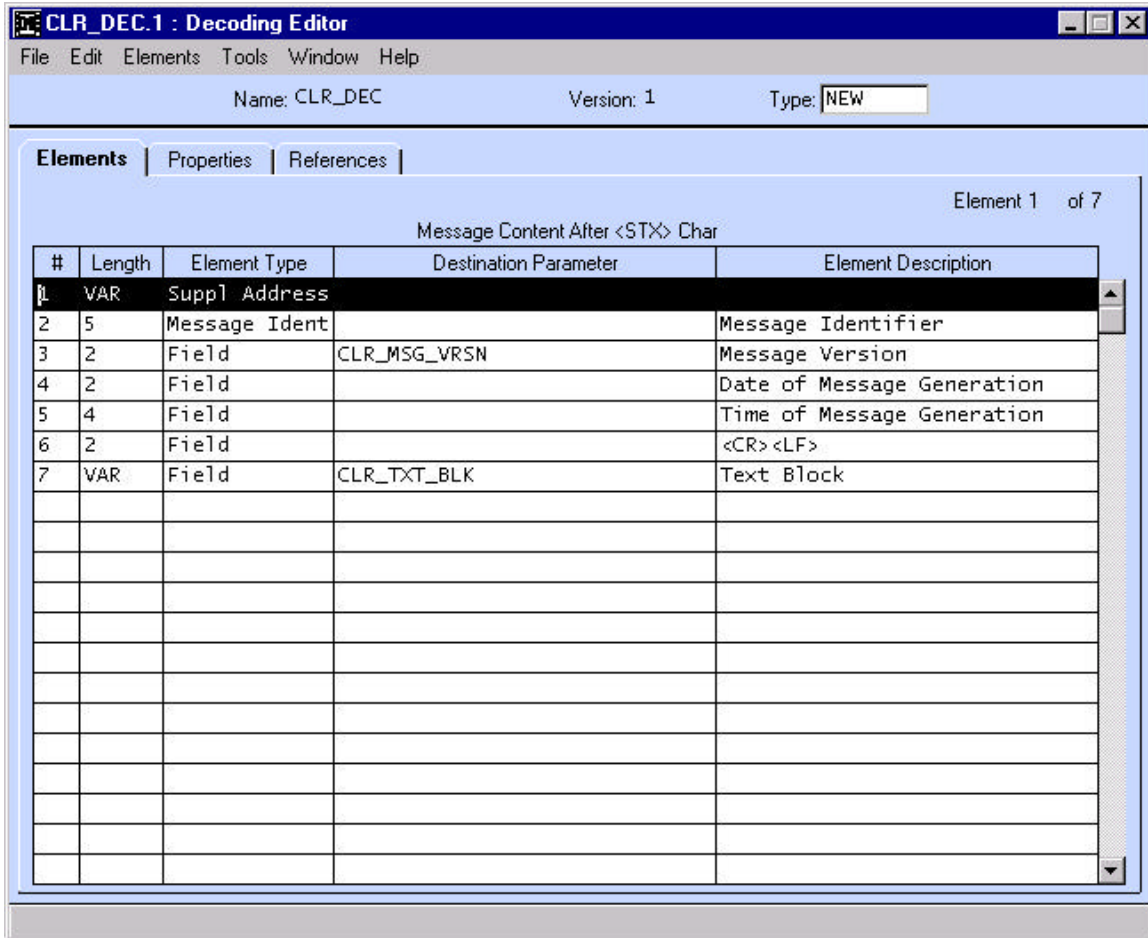
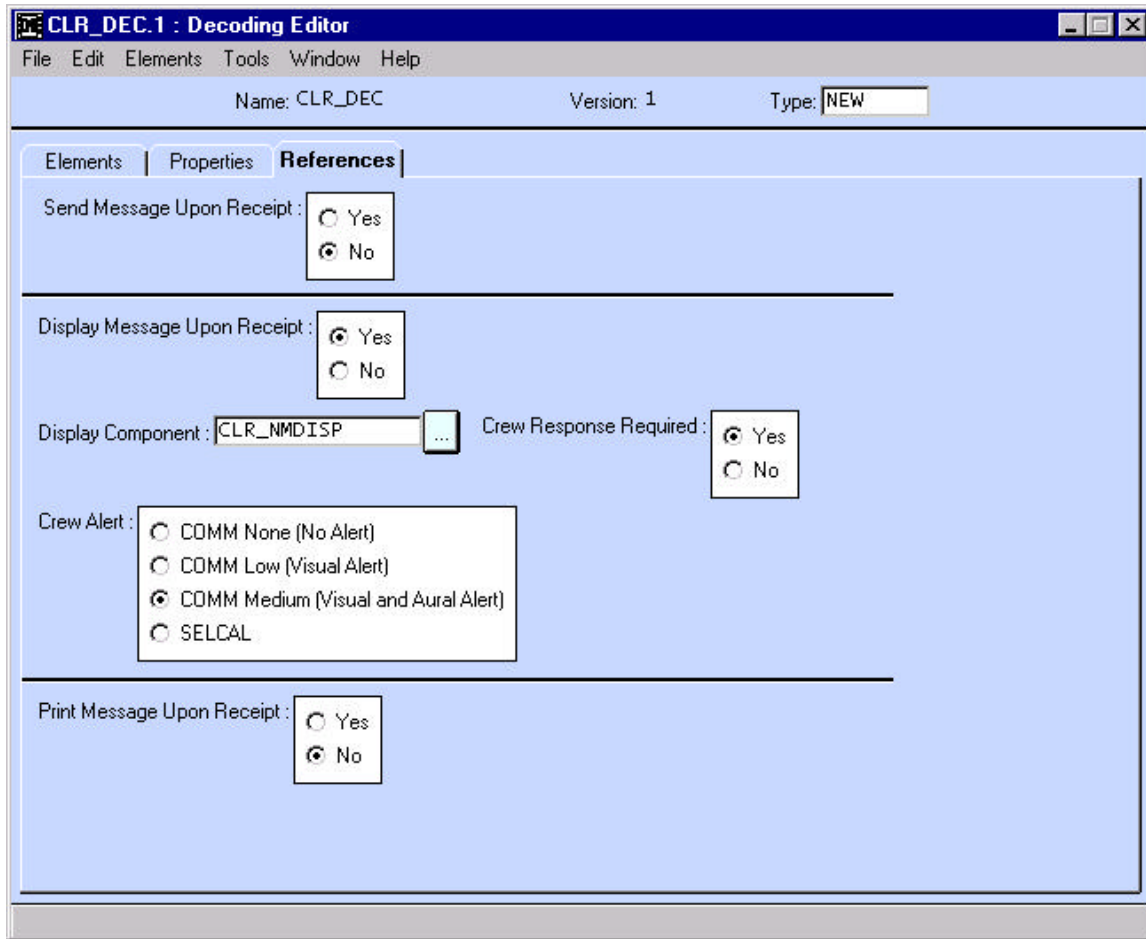

Figure 18 Clearance Message Elements



**Figure 19 Clearance Message References**

If a crew response is required, the user would typically create response action prompts, such as the ACCEPT and REJECT prompts shown in Figure 17. Selection of these prompts by the flight crew will send a message to the ground indicating acceptance or rejection of the Clearance message. The action prompts at the bottom of the screen are shown in yellow indicating that they are part of a common footer. This common footer allows the user to define a common set of objects to be placed at the bottom of each screen in a multiple screen display. In this case, the footer is common to both the Clearance Uplink screen and the Reject Reasons page.

The user can also specify a REJECT REASONS action prompt, which allows the flight crew to specify the reason for rejecting the Clearance (see Figure 20).

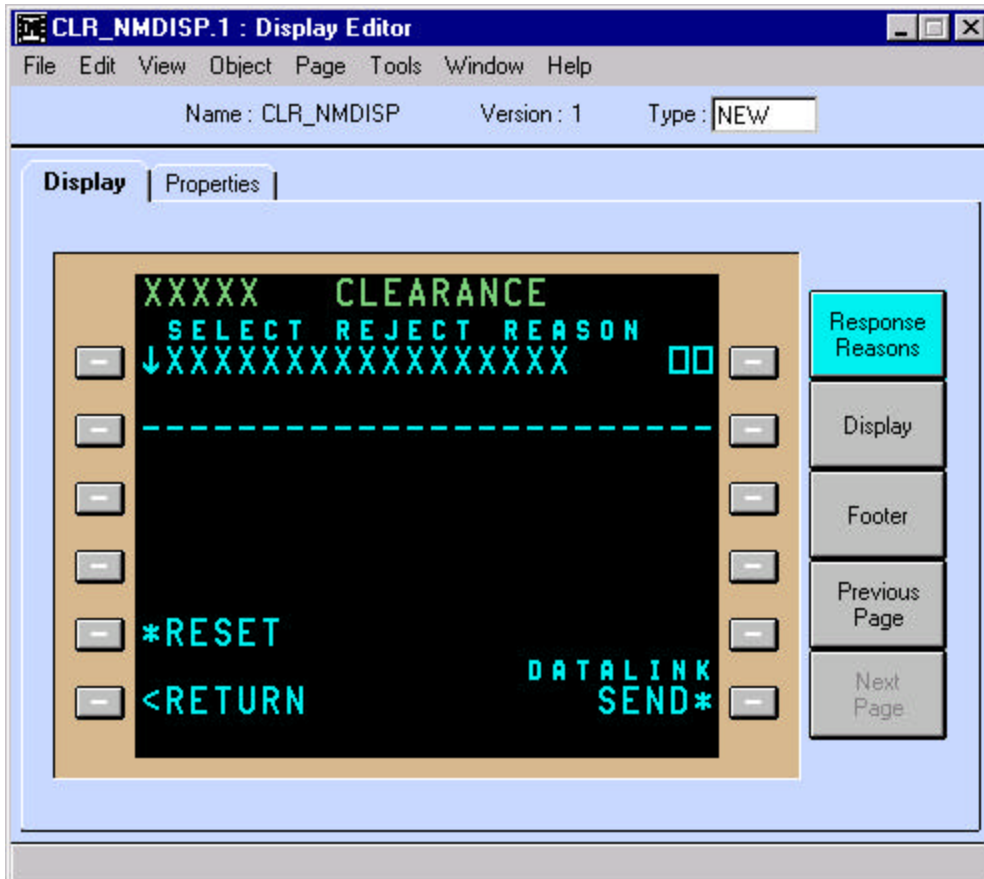

Figure 20 Reject Reasons

There are a number of different types of objects that can be placed on a display. As an example, for the Main Menu, page prompts are used to link to other pages. The Main Menu also used a constant text string for the title. The Clearance Uplink display had RETURN and PRINT prompts as well as the ACCEPT, REJECT, and RESP REASONS action prompts. Real-time parameters (such as from the FMS, or internally computed within the CMU, or received from other subsystems) can be displayed on screens. As an example, the Clearance Uplink display also contained a parameter being the value of the Clearance uplink text block.

The Response Reasons screen illustrates several other objects: mandatory entry box, optional entry box, and scrolling prompt. The mandatory entry box is indicated by boxes while the optional entry box is indicated with dashes. Alternatively, brackets can be used for optional data instead of dashes. A scrolling prompt object is preceded by a down arrow and provides the capability to scroll through a number of values. Figure 21 shows the values for the reject reason scroll prompt. The Reject Reasons page also utilizes conditional logic for field display. The optional entry box is only displayed for entry when the value of the reject reason is "other".

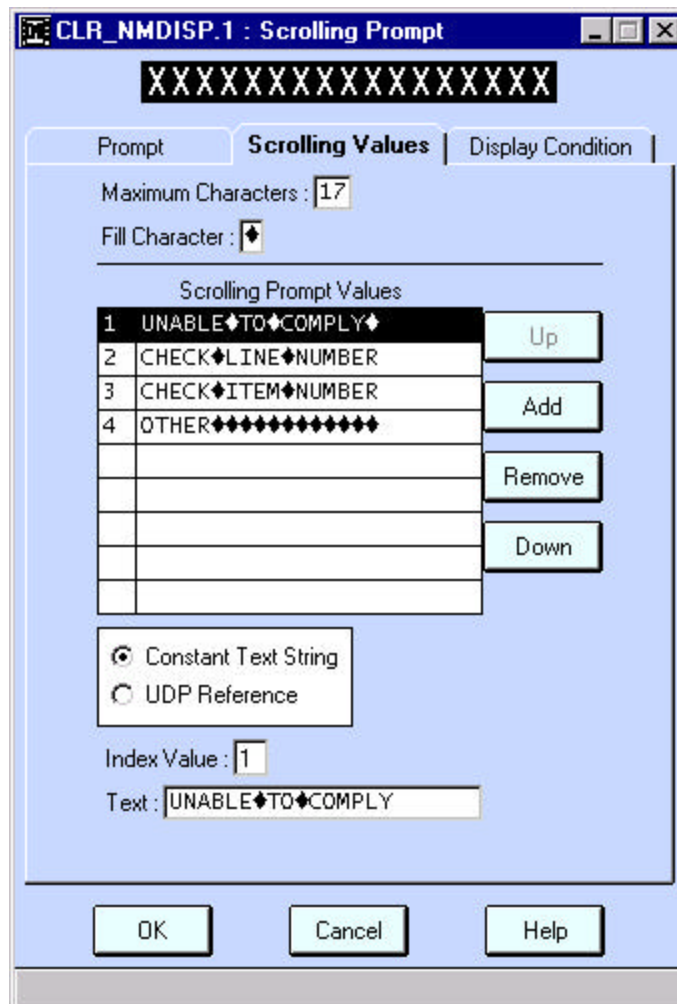

Figure 21 Reject Reasons Values

### 4.2.3 Downlinks

The definition of the AOC downlinks is created using the GBST. The definition of downlink message screens and associated message formats (encodings) is the same as for uplinks. Figure 22 is an example of a Diversion Report Downlink screen format.

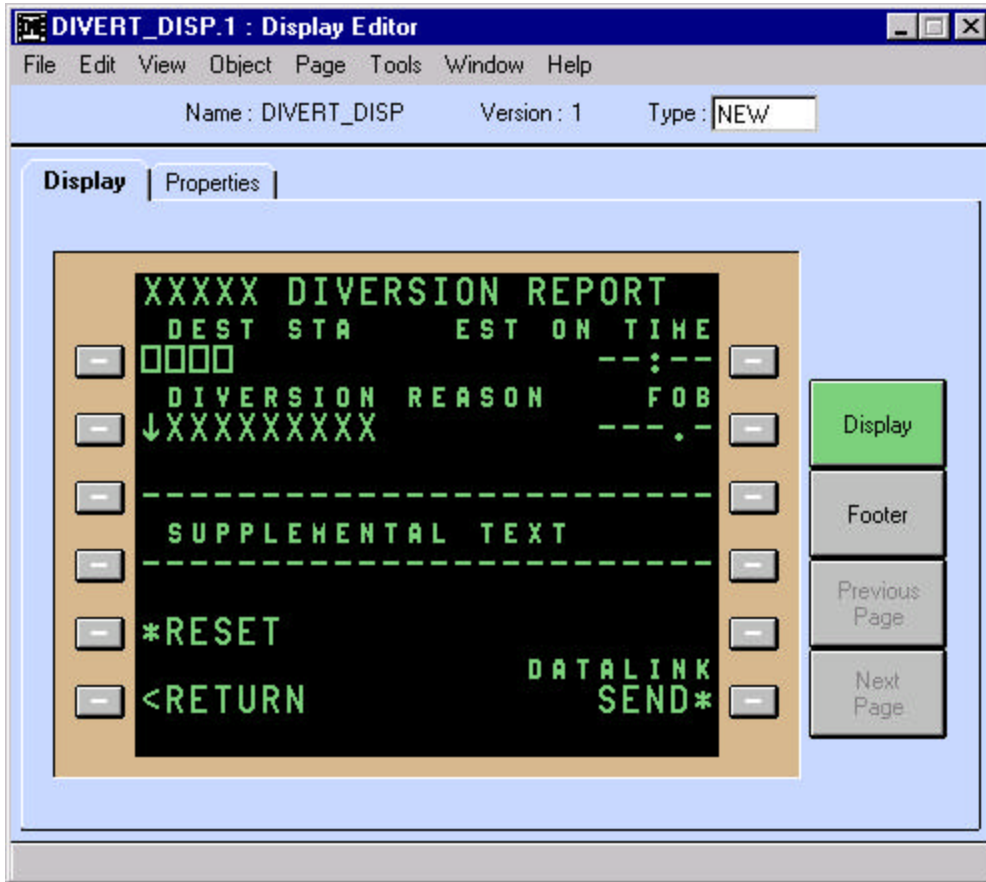
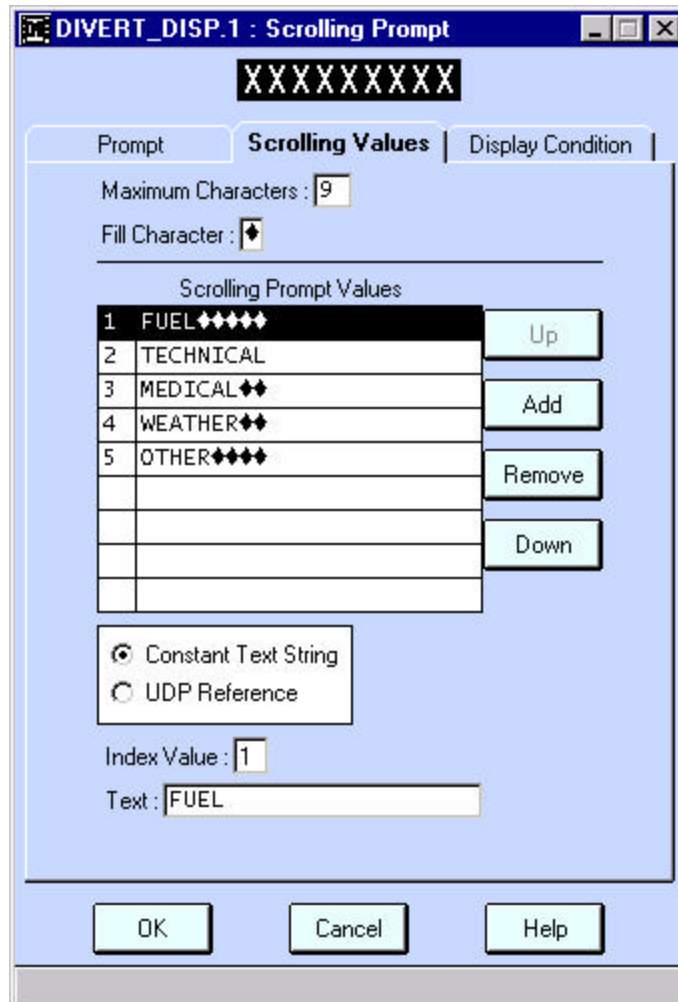

Figure 22 Diversion Report Downlink

Within the properties of the downlink message display, the user can specify the review category the message will be placed into.

Like the Reject Reasons page, the Diversion Report Downlink display contains a scrolling prompt and a conditional display field that is only displayed upon a certain value of the scroll field. Figure 23 shows the Diversion Reasons values. The text field below the diversion reason is only available when the diversion reason is "other".



**Figure 23 Diversion Reasons**

Two other object types that can be used on a display are toggle prompts and exclusive selector prompts (ESPs). Toggle prompts are a simple way of selecting from among one or more choices (ON/OFF). The Exclusive Selector Prompts are used to pick one (and only one) of two or more mutually exclusive choices. This is similar to the scroll prompt, but requires more display space (each choice must be placed on the display).

In addition to the downlink message screen definition, the user can define the downlink message format and characteristics (encodings). For downlink messages, the user defines the message elements (Figure 24) and the message properties (Figure 25). The message properties allows the user to define the downlink buffer and allowable subnetworks.



**DIVERT\_ENC.1 : Encoding Editor**

File Edit Elements Tools Window Help

Name: DIVERT\_ENC Version: 1 Type: NEW Element 1 of 22

Elements Properties

Message Content After <STX> Char

#	Length	Inclusion	Content	Element Description
1	10	Always	<seq_no><airline_ID><flight_no>	Standard ACARS downlink header
2	3	Always	"DIV"	Message Identifier
3	2	Always	"01"	Message Version Number
4	4	Always	<ACARS_FLIGHT_NUMBER>	ACARS Flight Number
5	1	Always	"/"	slash
6	2	Always	<INIT_SKED_DATE>	Scheduled Date
7	2	Always	<CURRENT_DATE>	Current Date
8	4	Always	<CURRENT_TIME>	Current Time
9	4	Always	<INIT_DEPT_STA>	Departure Station
10	4	Always	<DIV_DEST_STA>	Divert Destination Station
11	2	Always	"␣"	<CR><LF>
12	4	Always	<DIV_EST_ON_TIME>	Estimated On Time
13	4	Always	<DIV_FUEL_ON_BD>	Current Fuel on Board
14	1	Always	<DIV_CODE>	Diversion Code
15		Conditional	BEGIN_GROUP	Divert Reason = OTHER

Figure 24 Divert Message Elements

**DIVERT\_ENC.1 : Encoding Editor**

File Edit Elements Tools Window Help

Name: DIVERT\_ENC Version: 1 Type: NEW Element 1 of 22

Elements Properties

Message Type:  To Ground  On-Board Transfer

Message Encoded Parameter (optional): DIVERT\_BOOLEAN

Message Time Parameter (optional):

Invalid Pad Character: \*

Perishability:  Delete at System Reset  Delete on Buffer Full

Append CRC:  Yes  No

ACARS Label: 25

Downlink Priority: Aeronautical Administrative

Downlink Buffer: REPT

Allowable Subnetworks:  VHF  SATCOM  HF

Message Lifetime: 0 Minutes  
(Enter 0 for an infinite lifetime, 30 minutes max)

Figure 25 Divert Properties

## 4.2.4 Print Definition

The user can define the print format for a message by specifying the field names and associated parameters. Figure 26 shows the print format for a Flight Initialization uplink. This allows the user to define formats for uplink messages, as well as Mark III CMU generated reports to be easily readable by the flight crew. It also allows the flexibility to modify such formats as user requirements change.

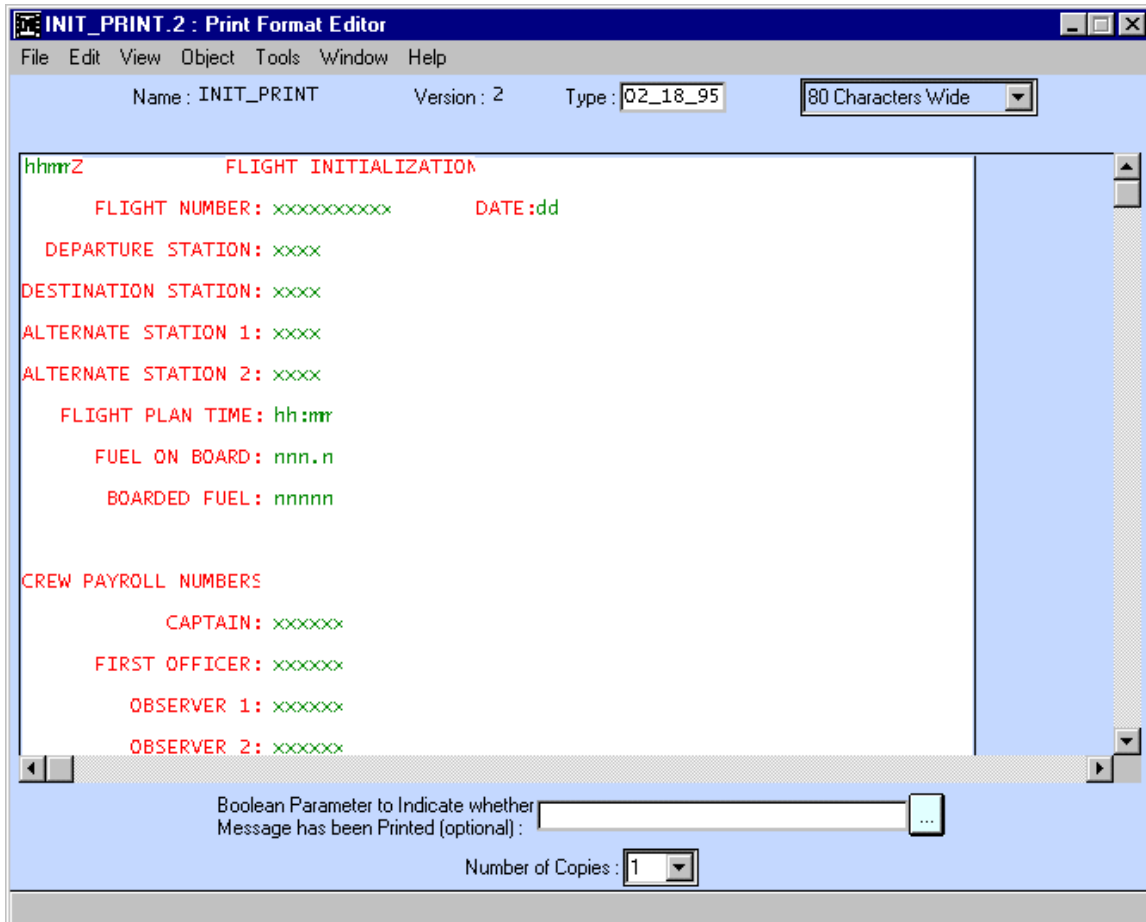
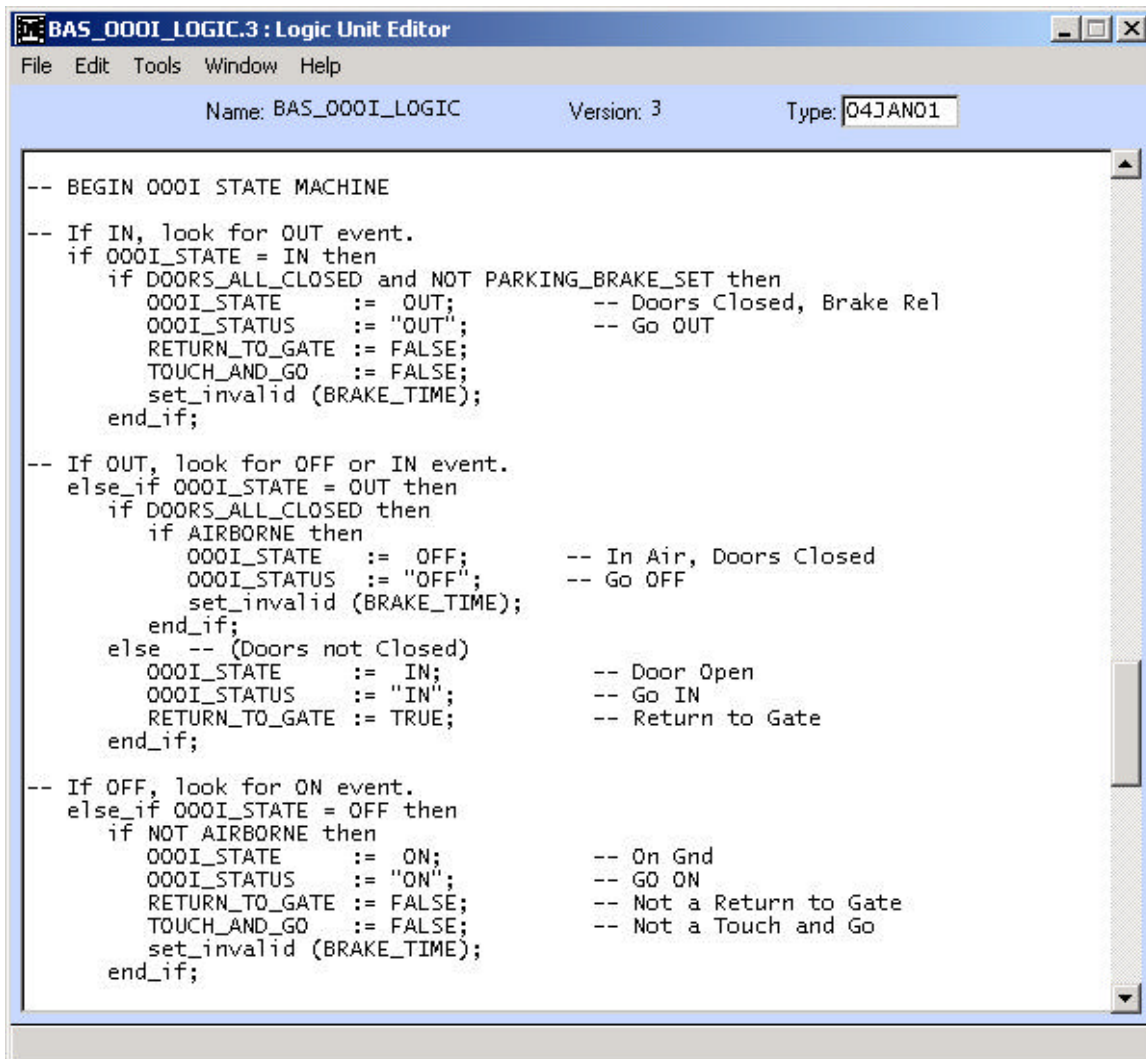

Figure 26 Print Format

## 4.2.5 Logic Units

In addition to the various display types and the conditional display options, the GBST provides an extremely powerful capability called logic units. Logic units allow a user to generate algorithms that can trigger events based upon certain conditions. This provides significant flexibility to a user as user requirements for datalink change, and more complex functions are required. The use of logic units provides a wide range of capabilities. For instance, a display object could be hidden on a screen and made visible only when a specific parameter exceeds a certain value. Logic units can be used to provide a mini-ACMS capability where a downlink message is generated and sent (without flight crew involvement) when a specific condition has been met (such as an engine exceedance). Further, the specified condition can be turned on and off or even changed based upon the value included in an uplink message.

Logic units can be used to specify OOOI conditions. OOOI logic can be as simple or as complex as the user requires. Figure 27 depicts a portion of an example logic unit for OOOI events.



```
-- BEGIN OOOI STATE MACHINE
-- If IN, look for OUT event.
if OOOI_STATE = IN then
  if DOORS_ALL_CLOSED and NOT PARKING_BRAKE_SET then
    OOOI_STATE := OUT;           -- Doors Closed, Brake Rel
    OOOI_STATUS := "OUT";       -- Go OUT
    RETURN_TO_GATE := FALSE;
    TOUCH_AND_GO := FALSE;
    set_invalid (BRAKE_TIME);
  end_if;
-- If OUT, look for OFF or IN event.
else_if OOOI_STATE = OUT then
  if DOORS_ALL_CLOSED then
    if AIRBORNE then
      OOOI_STATE := OFF;        -- In Air, Doors Closed
      OOOI_STATUS := "OFF";     -- Go OFF
      set_invalid (BRAKE_TIME);
    end_if;
  else -- (Doors not Closed)
    OOOI_STATE := IN;          -- Door Open
    OOOI_STATUS := "IN";       -- Go IN
    RETURN_TO_GATE := TRUE;    -- Return to Gate
  end_if;
-- If OFF, look for ON event.
else_if OOOI_STATE = OFF then
  if NOT AIRBORNE then
    OOOI_STATE := ON;          -- On Gnd
    OOOI_STATUS := "ON";       -- GO ON
    RETURN_TO_GATE := FALSE;   -- Not a Return to Gate
    TOUCH_AND_GO := FALSE;    -- Not a Touch and Go
    set_invalid (BRAKE_TIME);
  end_if;
```

Figure 27 OOOI Logic Unit

## 4.2.6 Preferred Channel Management

Honeywell first introduced the concept to the industry of automated frequency management based on aircraft position. This is in contrast to the brute force approach of performing frequency management by trial and error based on a table of possible frequencies. This automated approach provides for more flexibility for a user in terms of selecting service providers while also significantly improves frequency selection, avoiding problems of long frequency searches (of as much as 25 minutes), ensuring continuous linkage to the air/ground network. Preferred channel management is a mechanism that allows the user to closely control which communications medium (VHF, HF, SATCOM) and which VHF frequency (and thus service provider) to use in a particular region of the world. To facilitate this capability, GBST provides the mechanism to divide the world into regions. For each region, the user can specify the precedence of the communication channels

to use for message transmission. The user also can specify the set of VHF frequencies to use for that region. Figure 28 shows an example.

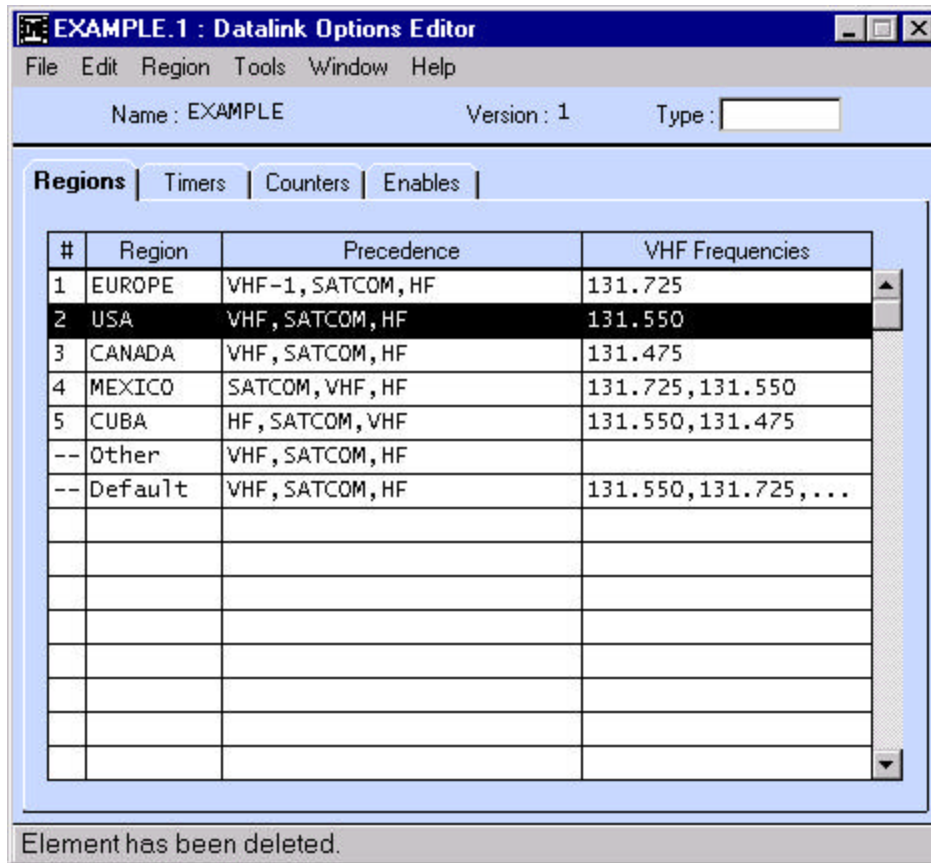

**Figure 28 Regions**

In this example, 5 regions are defined: Europe, US, Canada, Mexico, and Cuba. The OTHER region is used for all portions of the world not covered by the other user-defined regions. The DEFAULT region is used for the entire world when the aircraft position data is unavailable.

In this example if the aircraft is in the Mexico region, SATCOM would be the preferred subnetwork. However, if SATCOM is not available, VHF would be used with a frequency of 131.725. If that frequency is not available, then 131.550 would be used. If VHF is not available, then HF would be used.

This is a general algorithm based upon location within the world and is independent of message type. However, there may be cases where a user does not want certain messages to use certain subnetworks. For instance, the user may not wish to utilize HF for Divert Reports. The downlink message encoding property of the message allows the user to specify the set of allowable subnetworks.

Regions are defined to be the union of a set of areas with each area specified by a rectangle using latitude/longitude pairs. The capability to define areas within a region allows the user to more accurately define an irregularly shaped region. Using the map in Figure 29, the example USA region is comprised of three areas (Figure 30). Area 1 defines the continental US, area 2 defines Alaska, and area 3 Hawaii.

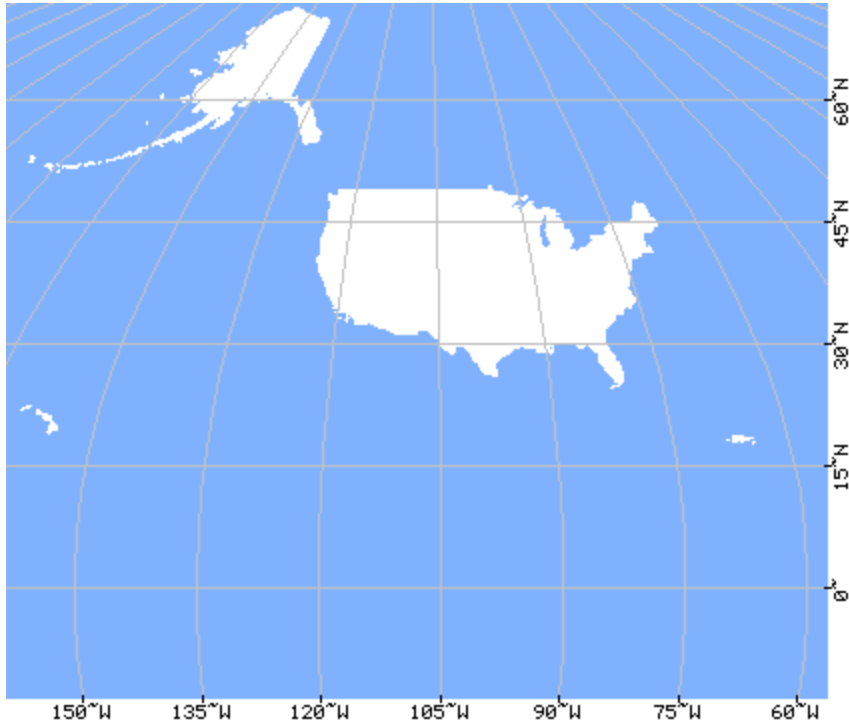
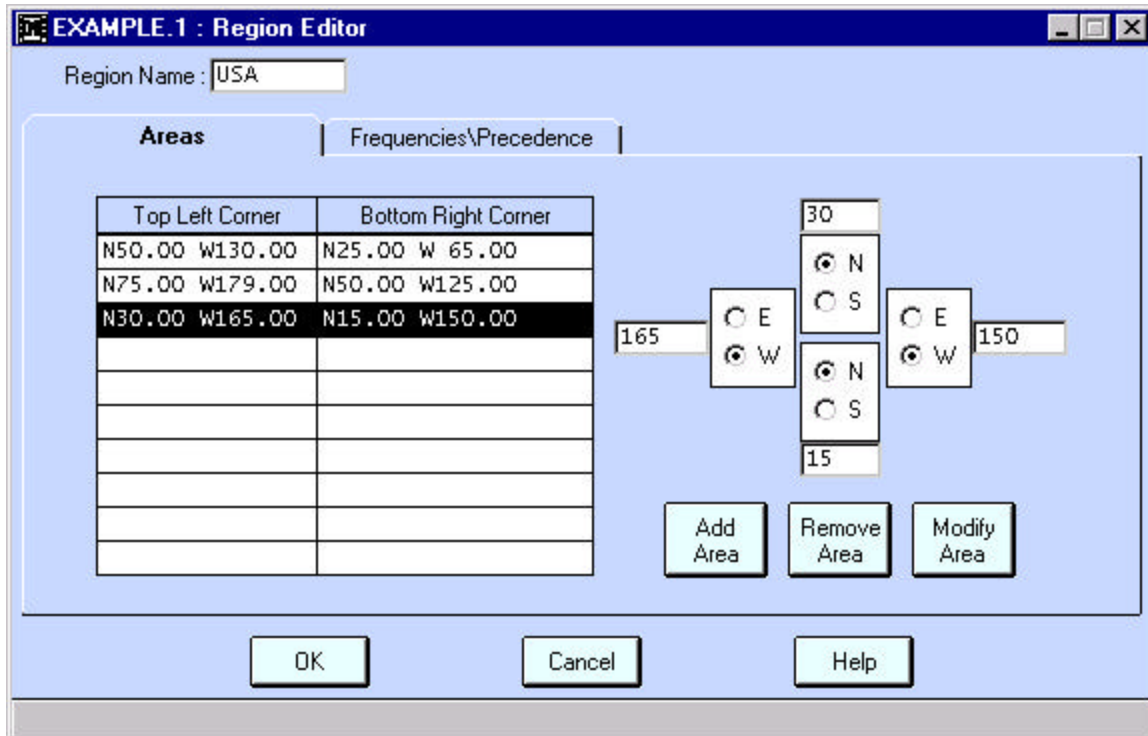

Figure 29 US Map



### **Figure 30 Areas**

The Mark III CMU GBST provides the next generation in Airline reconfiguration. It is specifically designed to provide airlines with the freedom and flexibility to customize the AOC functions in the CMU, and to allow users to expand the Mark III CMU as their requirements change. As part of the GBST, there is an extensive configuration control application built into the GBST, which allows airlines to manage the changes to the AMI database using the GBST. This includes both password controls as well as version control at the functional element level.

The GBST is an enhanced version of the GBST used for the B-777 system. As such, although there are more capabilities and features included, it provides the same basic interface as the B-777 GBST. Thus, airlines using the B-777 GBST will find that only minimal training is required due to the common human interface used between the two tools. The GBST for the Mark III CMU is also designed to operate on a PC, using either Windows NT or Windows 2000 (Windows 2000 recommended).

## 5 HARDWARE DESCRIPTION

### 5.1 Mechanical Design

The MARK III is a modular design that consists of a number of circuit card assemblies (CCAs) which are enclosed in a lightweight aluminum chassis. The internal interconnect between circuit card assemblies consists of a combination of highly reliable card-to-card connections and aerospace quality ribbon cables. The rear interconnect circuit card assembly provides most of the connections between CCAs.

The MARK III is designed so that it may be repaired and trouble-shot at the end-item level without expensive CCA level test equipment. The design is modular so that any CCA may be replaced with minimal effort. The MARK III consists of four CCAs with growth for two additional CCAs. These CCAs are described in the following sections. Figure 31 illustrates the top view of the Mark III CMU.

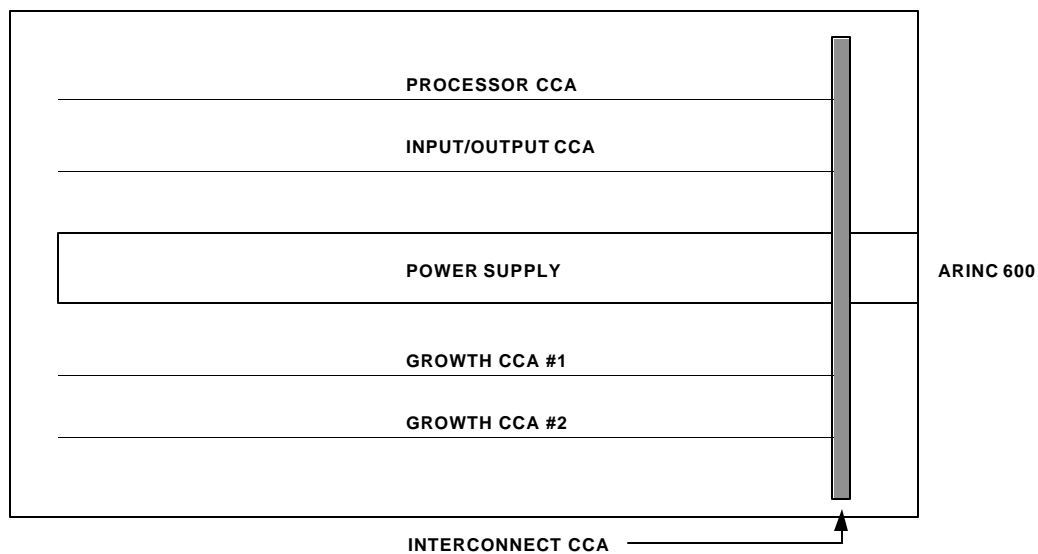

Figure 31 MARK III Top View

#### 5.1.1 Interconnect CCA

The A1 Interconnect circuit card assembly provides interconnect between the unit's rear ARINC 600 connector, the Processor CCA, Power Supply CCA and Input/Output CCA. The CCA has the following features:

Signals are routed in a multi-layer PWB that is designed to reduce emissions and RF Susceptibility. The circuit card assembly contains lightning suppression circuitry that meets the latest requirements of DO-160D. ARINC 600 connector pins are replaceable on an individual pin basis (front removable). The interconnection of plug-in CCAs is done by PCI Bus-Based connectors.

### 5.1.2 Processor CCA

The processor circuit card assembly contains the MARK III core microprocessor, supporting logic circuits, and memory devices. Significant features of the A2 CCA are as follows:

- Pentium Microprocessor
- Timers
- Heartbeat monitor contained in Field Programmable Gate Array (FPGA)
- 32 Megabytes DRAM
- 32 Megabytes Flash EPROM
- 128 Kilobytes EEPROM maintenance memory
- 512 Kilobytes battery-backed RAM
- BITE LED drivers
- PCMCIA receptacle
- Portable Data Loader Connector and Data Loader circuitry
- Local Power Circuitry
- BITE Circuitry
- Analog Discrete Inputs
- PCI BUS-based Connector

### 5.1.3 Power Supply CCA

The Power Supply circuit card assembly provides the power conversion for the LRU. Significant features of the A4 CCA are:

- Off-line conversion from either 115 Vrms, 400 Hertz aircraft power, or +28 Vdc aircraft power.
- Meets conducted emissions requirements of DO-160D.
- Capable of working through a 200 milli-second power interrupt.
- Outputs: 3.3 Vdc, +5 Vdc, -5 Vdc, +15 Vdc, -15 Vdc.
- Total maximum power capacity: 100 watts (consumption < 40 watts in Mark III configuration).
- BITE Circuitry.
- PCI BUS-based Connector.

### 5.1.4 Input/Output CCA

The significant features of the Input/Output CCA are:

- Two MPC-860 Power PC Microprocessors
- Two ARINC 429 16 Channel Transmitter and 32 Channel Receiver ASIC and associated buffer circuitry to support 12 outputs and 48 inputs
- DSP implementing ARINC 716 VHF Modem
- DSP implementing UHF Modem
- 32 Megabytes DRAM
- 16 Megabytes Flash EPROM
- Four 10-based T Ethernet Controllers and associated circuitry
- RS-422 Circuitry for 3 bi-directional ports.
- RS-232 Communication Port
- MIL-STD-1553B Data Bus Interface (military version only)
- 12-bit A/D converter for internal analog monitors
- Program pin buffers
- Failure lamp output discrete buffers
- Built-In Test Equipment (BITE)



- Patented multi-layer microstrip/fiberglass high reliability printed wiring board (PWB)
- Analog Output Discretes
- PCI BUS-based Connector

### **5.1.5 Spare CCAs (Growth)**

The MARK III provides two CCA growth slots for expansion. The growth slots may be used to provide an integrated VHF Data Radio (VDR) into the MARK III, memory expansion to allow the CMU to act as an aircraft file server, or other product variants.

Minimum features of the Spare CCAs are:

- PCI BUS-based Connector.
- BITE Circuitry.

## **5.2 Detailed Interface Definition**

Figure 32 and Figure 33 show the default external system interfaces supported by the MARK III CMU. The default external system interfaces, including the bus speeds, are modifiable using the APM.

The rear connector is a standard unit connector as defined in ARINC 758. The function and type of circuitry connected to the pin is listed in the table. All pins named 'Spare' are Honeywell reserved for future growth.

The front panel PDL circular connector is a standard 53-pin connector that is defined in ARINC 615. The function and type of circuitry connected to the pin is listed in the table. All function input and outputs are referenced to the CMU (DLT Input is input into the CMU and output from the terminal).

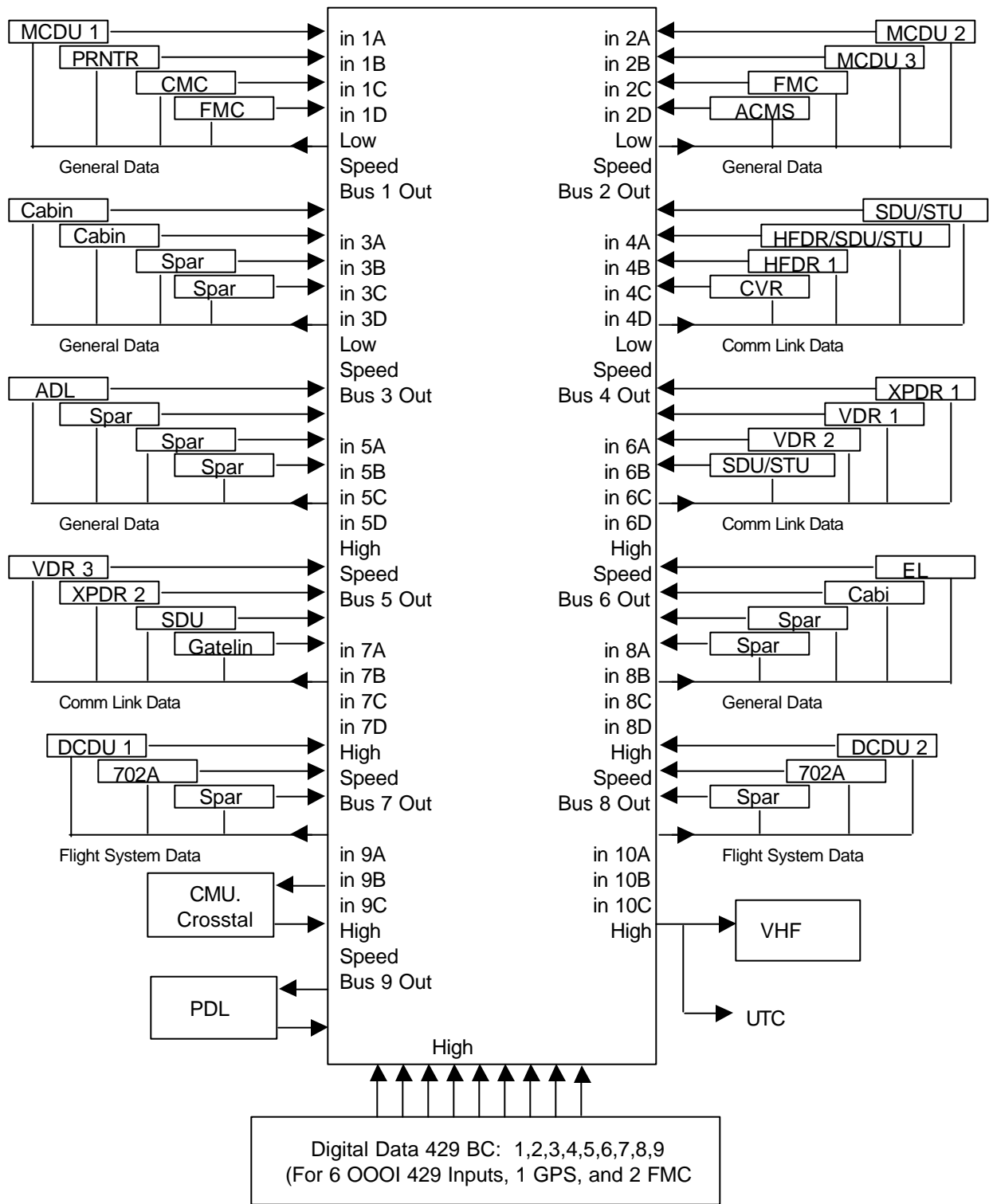

**Figure 32 Mark III Supported ARINC 429 Interfaces**

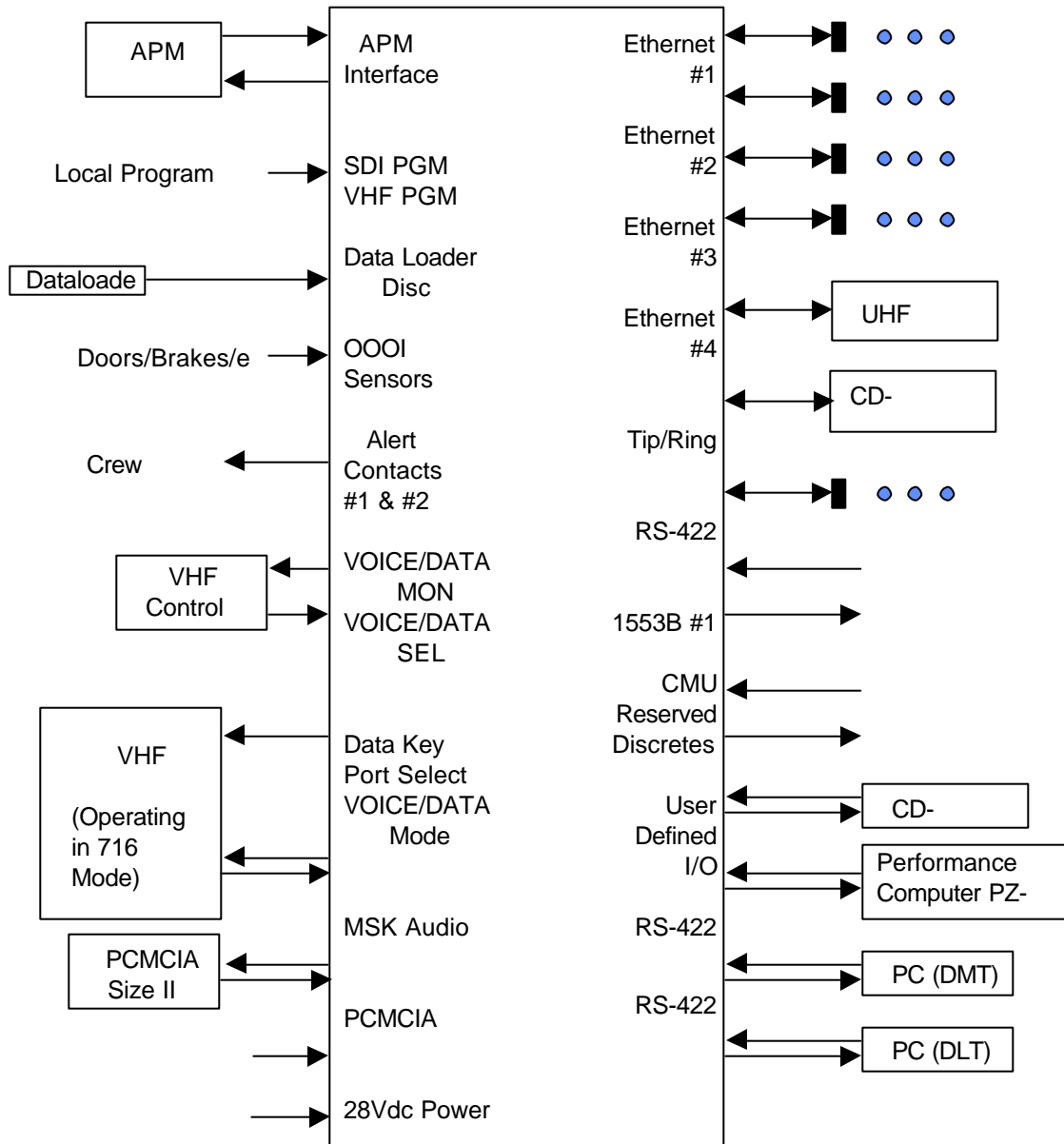

Figure 33 Mark III Supported Non-ARINC 429 Interfaces

## 5.3 Mechanical Packaging

### 5.3.1 Unit Weight

The MARK III LRU maximum weight is twelve pounds.

### 5.3.2 Unit Size

The MARK III LRU is a 4-MCU box that meets the dimensional specifications in ARINC 600. The unit has the following dimensions in inches:

	Width*	Height*	Length (Maximum)	Length+Front Face Projections (Maximum)
MARK III	4.88 ± .020	7.62 ± .020	12.76	15.26

\* Height and Width are for Unit Cover, the Front plate shall slightly exceed these dimensions.

### 5.3.3 Unit Connectors and Mounts

The MARK III provides a low insertion force, size 2, ARINC 600 rear connector shell assembly as defined in ARINC 758 for standard interconnect. The connector is located on the center grid of the MARK III rear panel.

The portable data loader connector that is contained on the unit's front panel is a 53-pin circular connector that as specified in ARINC 615 for standard interconnect. The PDL front panel connector that mates with the LRU is connector type MS27473T-18A-53P.

The mounting tray which is used for installing the unit in an aircraft may be any commercially available mount which is designed for the dimensional requirements in ARINC 600 for a 4-MCU unit. No special requirements exist for this mount.

### 5.3.4 Cooling Requirements

The MARK III is designed to accept cooling air using the method described in ARINC 600 or ARINC 404A. The nominal cooling airflow requirement for the MARK III per ARINC 758 is 22.0 kilograms/hour of 40 degrees centigrade (maximum) air. The coolant air pressure drop through the MARK III should be 25 ±2.5 millimeters of water.

If aircraft conditioned air is not available, the MARK III may be installed using an ARINC 600 equipment tray that has an integral cooling an installed in the plenum.

## 5.4 Environmental Specifications

The following DO-160D categories will be used for the MARK III:

### Temperature and Altitude (DO-160D Section 4.0)

#### Category A2, Partially controlled temperature, Pressurized to 15,000 feet

Operating temperature	-15C TO +70C
Short time high operating temp	+70C
Loss of cooling	+40C
Ground Survival	-55C to +85C
Altitude	15,000 feet
Decompression	55,000 feet
Overpressure	-15,000 feet

#### Category F2, Non-controlled temperature, Non-pressurized, 55,000 feet maximum

Operating temperature	-55C TO +70C
Short time high operating temp	+70C
Loss of cooling	+40C
Ground Survival	-55C to +85C
Altitude	55,000 feet
Decompression	N/A
Overpressure	N/A

### In-Flight Loss of Cooling (DO-160D Section 4.5.4)

#### Category W, 90 minutes minimum

The MARK III shall be able to operate with no forced cooling air at an ambient of +40° Celsius for a period of 90 minutes.

### Temperature Variation (DO-160D Section 5.0)

#### Category B, Non-controlled temperature, Equipment mounted internal in aircraft

The maximum temperature variation rate is 5° Celsius per minute.

### Humidity (DO-160D Section 6.0)

#### Category B, Severe Humidity environment

The unit shall withstand a 95% humidity, 10 day cycle.

### Shock (DO-160D Section 7.0)

#### Category – B

### Vibration (DO-160D Section 8.0)

#### Category – (UFF1)(SCLMY)

### Explosion Proofness (DO-160D Section 9.0)

#### Category E

Non hermetically sealed equipment which meets the test requirements of environment I.

**Waterproofness (DO-160D Section 10.0)**

Category X, Not Applicable

**Fluids Susceptibility (DO-160D Section 11.0)**

Category X, Not Applicable

**Sand and Dust (DO-160D Section 12.0)**

Category X, Not Applicable

**Fungus Resistance (DO-160D Section 13.0)**

Category X, Not Applicable

**Salt Spray (DO-160D Section 14.0)**

Category X, Not Applicable

**Magnetic Effect (DO-160D Section 15.0)**

Category Z, Less than 0.3m for 1 degree deflection

**Power Input (DO-160D Section 16.0)**

Category E (AC Power), Equipment requiring AC Power.

Category B (DC Power), Electrical systems supplied by generators/alternators with a battery.

Category Z (DC Power), Electrical systems without a battery of significant capacity.

**Voltage Spike (DO-160D Section 17.0)**

Category A, High degree of protection against voltage spikes (For both 115 Vac and 28 Vdc Versions).

**Audio Frequency Susceptibility (DO-160D Section 18.0)**

Category E (AC Power), Equipment requiring AC Power.

Category Z (DC Power), Electrical systems without a battery of significant capacity.

**Induced Signal Susceptibility (DO-160D Section 19.0)**

Category Z

**RF Susceptibility (Radiated and Conducted) (DO-160D Section 20.0)**

Category *RRR*

**Emission of RF Energy (DO-160D Section 21.0)**

Category M

**Lightning Indirect Effects (DO-160D Section 22.0)**

Category A2E2, Equipment and interconnect wiring installed in a moderately exposed environment

Category A2, Pin Injection Tests (DO-160C Section 22.5.1)

Waveform 3 (DO-160D Section 22, Figure 22-4), Voc/Isc = 250V/10A, and Frequency = 1 Mhz ± 20%.

Waveform 4 (DO-160D Section 22, Figure 22-5), Voc/Isc = 125V/25A.

Category E3, Cable Bundle Tests, Cable Induction (DO-160C Section 22.5.2)

Waveform 1 (DO-160D Section 22, Figure 22-2), VI/It = 300V/600A.

Waveform 3 (DO-160D Section 22, Figure 22-4), Vt/It = 600V/120A, and Frequency = 1 Mhz and 10 Mhz

**Lightning Direct Effects (DO-160D Section 23.0)**

Category X, Not Applicable

**Icing (DO-160D Section 24.0)**

Category X, Not Applicable

**ESD (DO-160D Section 25.0)**

Category A, Equipment Installed, Repaired, or operated in an Aerospace Environment

**DO-160D Marking (DO-160D Appendix A)**

[(A2)(F2)W]BBB[(UF)(SCLMY)]EXXXXXZ[EBZ]A[EZ]Z[RRR]M[A2E3]XXA

**5.5 Power Requirements**

The MARK III is able to accept either 115 Vac 400 Hertz and/or 28 Vdc input power. The unit is designed so that if both sources are inadvertently connected, the MARK III or aircraft will not be damaged.

The following subsections specify the unit's power requirements and operating conditions:

**5.5.1 115 Vac Input Power Requirements**

The MARK III meets DO-160D Section 16.0 category E requirements. It has the following operating voltage and frequency specifications and input power requirements:

<u>Operating Voltage</u>		<u>Operating Frequency</u>		<u>Power Consumption</u>	
Nominal	115 Vrms	Nominal	400 Hertz	Nominal	50 Watts
Minimum	97 Vrms	Minimum	320 Hertz	Maximum	100 Watts
Maximum	134 Vrms	Maximum	480 Hertz		

**5.5.2 28 Vdc Input Power Requirements**

The MARK III meets DO-160D Section 16.0 category BZ requirements. It has the following operating voltage and input power requirements:

<u>Operating Voltage</u>	<u>Power Consumption</u>
--------------------------	--------------------------

Nominal	+27.5 Vdc	Nominal	50 Watts
Minimum	+20.5 Vdc	Maximum	100 Watts
Maximum	+32.2 Vdc		

### 5.5.3 28 Vdc Backup Input Power Requirements

The MARK III does not require use of standby 28 Vdc Battery Backup Input Power.

### 5.5.4 Power Interrupt Requirements

The MARK III shall be capable of continuous operation through any power-off transient under 200 milliseconds. Non-volatile data shall be unaffected by Input Power Loss and does not depend upon a standby 28 Vdc Battery Bus, if the aircraft is so equipped.



## 6 SUMMARY

The Mark III CMU is a high-end system which provides the latest in both hardware and software technology, unequalled in the industry. In addition to the Mark III CMU, Honeywell also manufactures a Mark II CMU, which is provided for both 724B wiring or 758 wiring, as well as other datalink related products including cockpit printers, Multi-Input Interactive Display Units (MIDUs); and VHF, HF and SATCOM systems. The following provides a summary of the Mark III CMU.

### Technical Summary

The Mark III CMU is a high end CMU with significant advancement over all other ACARS / CMU products in the market today. The Mark III CMU hardware platform has been designed as a modular avionics platform which can not only be used as a CMU, but adapted to other future potential uses. It is a 4 MCU unit, which complies to the new ARINC 758 CMU characteristic, while providing flexibility to add in additional functionality in the future to expand it's capability to our airline customers. Today's ACARS and CMU systems provide processor performance capabilities in the range of 5 to 50 MIPS (Millions of Instructions Per Second) and from 1 to 6 Mbytes of Memory. The Mark III CMU is a much higher end system, and has greater than 400 MIPS of processing capability and over a 100 Mbytes of memory. Although only a fraction of this processor and memory capability is used today, this unprecedented growth capability has been designed into the unit to ensure the lowest life cycle cost and long term growth capability to our customers. This will be a significant factor over the next ten to fifteen years, as the use of datalink, such as for Air Traffic Control communication continues to evolve. Such future processing as the addition of the Aeronautical Telecommunication Network (ATN)<sup>3</sup>, ATC unique applications, and the addition of new communication protocols will require more and more processor and memory capabilities within the CMU. Much of this new technology is just now being defined within the industry and will continue to be evolving over the next ten years. It is because of this evolution, that we have developed this high end platform with such significant growth capability, providing the lowest risk hardware platform for ensuring such upgrades can be supported in the unit you purchase today.



**Mark III CMU has Over 400 MIPS of Processing Power and Over 100 Mbytes of Memory – Designed to Support Long Term Growth without Hardware Changes**

The Mark III CMU hardware has also been designed to not only meet the required interfaces as identified in the new ARINC 758 characteristic, but contains additional interfaces to support potential future growth options. As an example, The Mark III CMU comes standard with four (4) Ethernet ports. These ports provide growth capability to support future interfaces, without the need to perform hardware modifications, requiring software only modifications. The Mark III CMU also includes a UHF modem for future use. Thus, we are well positioned for such future changes such as the use of Ethernet links for dataloading, or other high speed interfaces that may be defined by the industry in the future.

<sup>3</sup> The ATN software is the next generation CMU air to ground and ground-to-ground protocols. The ATN is the ICAO defined protocols that will be used in the future as ATC communication transitions from voice to datalink. Honeywell has a unique position relative to the ATN, in that as program manager and one of the primary developers of the ATN router software (under contract to ATNSI), Honeywell is the only CMU manufacturer involved in the actual development of this future technology. Thus although the ATN will not be in operational use for at least several years, Honeywell has the technical expertise to assist our customers as such transition occurs in the future.

The Mark III CMU has also been designed to support a future upgrade for new Gatelink technology. With the advent of commercialized 2.4 GHz spread spectrum wireless communication, a new technology is emerging for the airline industry for providing the ability to transmit very large data packets from and to the aircraft when in the vicinity of a short range transceiver (commonly referred to as Gatelink). This new technology has significant potential advantages in the future due to the high transfer rates (between 1 and 11 Mbits/ second), and the fact that this technology uses an unlicensed frequency band. This technology is also being defined to interoperate with normal Intranet / Internet based systems, providing significant growth capability for seamless interoperability with an airlines existing computer network. Honeywell has recognized the potential of this new technology, and as such has designed into the Mark III CMU the ability to upgrade the unit in the future to support such capability on the aircraft. This includes the use of using one of the existing Ethernet ports within the Mark III CMU to communicate with the our wireless transceiver/antenna which would be added to the aircraft in the future to support the Gatelink transmissions.

Similar to the Mark III CMU hardware, the Mark III Software architecture within the unit has taken the next leap forward in technology. Honeywell, which first introduced and certified user-reconfigurable ACARS to the industry in 1991, is providing a new degree of functionality in the area of user reconfiguration. In addition to allowing airlines to add, delete and modify such functions as the flight crew MCDU screens, and downlink messages, the Mark III CMU architecture incorporates what is referred to as the AOC software completely within a database. Thus, logical processing such as the definition of trigger algorithms for sending messages automatically, are no longer defined in software, but are part of the user reconfigurable database. This provides an additional

degree of flexibility to airlines, allowing you to add or modify logical elements within the CMU. In contrast, other systems require such logical processing changes to be performed by the CMU manufacturer (within their AOC software). Thus such processing as determining flight phases (such as OUT, OFF, ON and IN events), various exceedance conditions, and other logical processing for sending downlink messages can be defined in a database, modifiable by either Honeywell or the airline. This flexibility to define logic conditioning within the Mark III CMU has been expanded to other areas of the system as well, such as allowing increased flexibility in controlling what is displayed on the MCDU; and conditional processing for determining what information to include in downlinks and printer based reports. All such capability is able to be performed without impacting the certification status of the unit. All of the Mark III CMU operational software and database are software loadable into the unit, allowing updates without removing the system from the aircraft. In addition, due to the size of the memory on the Mark III CMU, the Mark II CMU is capable of a single database across all of the aircraft in an airline's fleet of aircraft. This will allow an airline to have not only the same software but also the same database (thus identical and single configuration) across the complete fleet.

The Mark III CMU also incorporates a certified database which is used to implement changes to certified components easily, versus requiring software modifications. As an example the ARINC 623 ATC messages are contained in this certified database, which would also be expanded in the future as other ATC messages become operational.

The Mark III CMU also has added in special software and hardware that supports Honeywell's NZ FMS / CDU, used on many regional aircraft such as the Embraer 135/145 as well as other types of aircraft. These aircraft which do not use the traditional ARINC 739 protocol, can now have the latest in Datalink technology, through the use of the Mark III CMU's special processing for such aircraft types.



***GBST Reconfiguration Tool Provides Airlines complete flexibility and control over changing AOC algorithms, through the use of Pseudo software lanuaae.***

The Mark III CMU is designed to provide airlines with a hardware platform with the best growth potential of any system in the market. Not only does it contain significantly more processing power than other systems; it is also designed to support such future capabilities as Gatelink. The software within the Mark III CMU is also designed to provide customers with more control over AOC functional changes. This is accomplished using the GBST reconfiguration tool, which allows airlines to modify the logical processing in addition to such items as MCDU screens and downlink messages.

As the leading provider of Datalink systems, with over 100 customers, Honeywell provides our customers with extensive experience in the area of datalink. This includes our unique ability to be able to offer datalink systems which span every possible aircraft you may operate, including providing ATSU AOC software for the new Airbus aircraft, the datalink functions within the AIMS B-777 aircraft, to CMUs for aircraft ranging from Embraer 135/145s to wide body aircraft such as 747s. In addition, Honeywell's Mark III CMU software is also being used as the software for our latest integrated avionics platforms such as the EPIC and VIA platforms. This includes providing the datalink function for the VIA platforms to be used on C-5 and KC-10 aircraft. Honeywell also is investing in the future. As an example, the future ATN software to be used in the future CNS/ATM-1 environment, is currently being developed by an international consortium of companies, including Honeywell, the only CMU manufacturer involved in its development.

In addition to offering all of today's datalink avionics, Honeywell also offers ground-based solutions to airlines, ranging from services provided by our Global Data Center (which currently supports over 2,200 datalink-equipped aircraft); to on-site systems such as our AMOSS system. If more information on the Mark III CMU is needed, or on any other information on our Datalink products and service, please contact your Honeywell representative.

## Free Manuals Download Website

<http://myh66.com>

<http://usermanuals.us>

<http://www.somanuals.com>

<http://www.4manuals.cc>

<http://www.manual-lib.com>

<http://www.404manual.com>

<http://www.luxmanual.com>

<http://aubethermostatmanual.com>

Golf course search by state

<http://golfingnear.com>

Email search by domain

<http://emailbydomain.com>

Auto manuals search

<http://auto.somanuals.com>

TV manuals search

<http://tv.somanuals.com>