



PW-6000

Intelligent Controller

Installation and Configuration Guide

Part Number: PW6K1IC

Copyright© 2007 Honeywell. All rights reserved.

All product and brand names are the service marks, trademarks, registered trademarks, or registered service marks of their respective owners. Printed in the United States of America. Honeywell reserves the right to change any information in this document at any time without prior notice.

Microsoft and Windows are registered trademarks of Microsoft Corporation. Windows Server is a trademark of Microsoft Corporation.

Ordering Information

Please contact your local Honeywell representative or visit us on the web at www.honeywellaccess.com for information about ordering.

Feedback

Honeywell appreciates your comments about this manual. Please visit us on the web at www.honeywellintegrated.com to post your comments.

CONTENTS



Notices.....	1
Warnings and Cautions	1
Damage During Shipment	2
Electro Static Discharge	2
Disclaimer – Product Liability; Mutual Indemnification	3
Unpacking Procedure	3
Shipping Instructions	3
Limited Warranty	4
Confidentiality	4
Product Overview.....	5
PW-6000 and PW-5000.....	5
Port Settings.....	5
Other	6
Setting Up the PW-6000 Hardware.....	8
Setting the Jumpers.....	8
Setting the DIP Switches	9
Technical Specifications.....	11
Status LEDs	12
Supplying Power to the PW-6000 Interface	13
Communications Wiring.....	14
Cabinet Tamper and Power Failure Input Wiring	14
Memory and Real Time Clock Backup Battery	14
System Configuration via Web Interface.....	15
Connecting to ACDSM for the First Time	15
Login Page.....	15
Home Page.....	16
Network Settings	17
Host Port.....	18
Device Information.....	22
User Configuration	23
Restore Default Screen	24
Apply Setting Screen	25
Log Out.....	25
Appendix A	27

LIST OF FIGURES



Figure 1: PW-6000 Connections, LEDs, and DIP Switches	7
Figure 2: PW-6000 Power Terminals	13
Figure 3: PW-6000 Port Wiring	14
Figure 4: PW-6000 TMP and FLT Terminals	14
Figure 5: PW-6000 Web Server Login Screen	15
Figure 6: PW-6000 Web Server Home Page	16
Figure 7: PW-6000 Web Server Network Settings Screen	17
Figure 8: PW-6000 Host Port Configuration Screen with IP Server Connection	18
Figure 9: PW-6000 Host Port Configuration Screen with IP Client Connection	20
Figure 10: PW-6000 Host Port Configuration with Serial RS-232 Connection	21
Figure 11: PW-6000 Web Server Device HW Info Screen	22
Figure 12: PW-6000 Web Server User Info Screen	23
Figure 13: PW-6000 Web Server Restore Default Screen	24
Figure 14: PW-6000 Web Server Apply Setting Screen	25

LIST OF TABLES



Table 1	PW-6000 Jumper Settings	8
Table 2	PW-6000 DIP Switch Settings	9
Table 3	PW-6000 Technical Specifications	11
Table 4	PW-6000 Status LED Combinations During Initialization	12
Table 5	PW-6000 Status LED Combinations During Run Time	13



PW-6000 Installation

1 Notices

1.1 Warnings and Cautions

Before Installation



Warning: Before installation, **TURN OFF** the external circuit breaker which supplies power to the system.

Before connecting the device to the power supply, verify that the output voltage is within specifications of the power supply (see '[Technical Specifications](#)' on page 11).

Do not apply power to the system until **after** the installation has been completed. Personal injury or death can occur, and the equipment can be damaged beyond repair, if this precaution is not observed.

Fire Safety and Liability Notice



Warning: Never connect card readers to any critical entry, exit door, barrier, elevator or gate without providing **an alternative exit** in accordance with all the fire and life safety codes pertinent to the installation.

These fire and safety codes vary from city to city and you must get approval from local fire officials whenever using an electronic product to control a door or other barrier. Use of egress buttons, for example, may be illegal in some cities. In most applications, single action exit without prior knowledge of what to do is a life safety requirement. Always make certain that any required approvals are obtained in writing. **DO NOT ACCEPT VERBAL APPROVALS SINCE THEY ARE NOT VALID.**

Honeywell Integrated Security never recommends using the PW-6000 or related products for use as a primary warning or monitoring system. Primary warning or monitoring systems should always meet the local fire and safety code requirements. The installer must also test the system on a regular basis by instructing the end user in appropriate daily testing procedures. Failure to test a system regularly could make the installer liable for damages to the end user if a problem occurs.

Earth Grounding



Warning: EARTH ground all enclosures for proper installation.

Use Suppressors



Warning: Use suppressors on all door strikes. Use S-4 suppressors for installation. Honeywell Integrated Security, Inc. recommends only DC strikes.

1.2 Damage During Shipment



Caution: IF ANY DAMAGE TO THE SHIPMENT IS NOTICED, A CLAIM MUST BE FILED WITH THE COMMERCIAL CARRIER RESPONSIBLE FOR THE DAMAGE.

1.3 Electro Static Discharge



Caution: Electro-static discharge (ESD) can damage CMOS integrated circuits and modules.

To prevent damage always follow these procedures:

- Use static shield packaging and containers to transport all electronic components, including completed reader assemblies.
- Handle all ESD sensitive components at an approved static-controlled workstation. These workstations consist of a desk mat, floor mat and an ESD wrist strap. Workstations are available from various vendors.



Note: This equipment has been tested and found to comply with the limits for a Class A digital device, pursuant to part 15 of the FCC Rules. These limits are designed to provide reasonable protection against harmful interference when the equipment is operated in a commercial environment. This equipment generates, uses, and can radiate radio frequency energy and, if not installed and used in accordance with the installation and user guides, may cause harmful interference to radio communications. Operation of this equipment in a residential area is likely to cause harmful interference in which case the user will be required to correct the interference at his own expense.



Note: This document and the data in it shall not be duplicated, used or disclosed to others for procurement or manufacturing, except as authorized by and with the written permission of Honeywell Integrated Security, Inc. The information contained in this document or in the product itself is the exclusive property and trade secrets of Honeywell Integrated Security, Inc. Copyright laws of the United States protect all information in this document or in the software product itself.



Note: Any use of this product is subject to the terms and acceptance of the Honeywell Integrated Security, Inc. Software Agreement. Please request a copy from Honeywell Integrated Security, Inc. (<http://www.honeywellintegrated.com/index.html>), and review the agreement carefully.

1.4 Disclaimer – Product Liability; Mutual Indemnification

If a Customer receives a claim that a Product or any component thereof has caused personal injury or damage to the property of others, Customer shall immediately notify Honeywell Integrated Security in writing of all such claims. Honeywell Integrated Security shall defend or settle such claims and shall indemnify and hold Customer harmless for any costs or damages including reasonable attorneys' fees which Customer may be required to pay as a result of the defective Product or the negligence of Honeywell Integrated Security, its agents, or its employees.

Customer shall hold harmless and indemnify Honeywell Integrated Security from and against all claims, demands, losses and liability arising out of damage to property or injury to persons occasioned by or in connection with the acts or omissions of Customer and its agents and employees, and from and against all claims, demands, losses and liability for costs of fees, including reasonable attorneys' fees, in connection therewith.

1.5 Unpacking Procedure



Caution: If any damage to the shipment is noticed before unpacking, a claim must be filed with the commercial carrier.

All containers should be opened and unpacked carefully in order to prevent damage to the contents.

Follow these steps to unpack equipment in preparation for installation:

1. Open the container and remove the unit(s) and all packing material. Retain the container and all the packing materials. They may be used again for reshipment of the equipment, if needed.
2. Inspect the contents to see if anything is missing. If you notice any missing items, contact the order entry department at 1-800-323-4576 Option-1.
3. Visually check the contents. If you see any damage, do the following:
 - a. If shipping has caused damage to the unit, a claim must be filed with the commercial carrier.
 - b. If any other defect is apparent, call for a return authorization.

1.6 Shipping Instructions

To ship equipment back to Honeywell Integrated Security, contact the customer service department at 1-800-323-4576 before returning the equipment. When you call, please have available:

- A description of the problem or the reason you are returning the equipment.
- Your original purchase order number, invoice number and if the unit is still under warranty.
- A new purchase order number if the unit is not under warranty

From the customer service department, obtain the **Return Authorization Number (RMA)**.

Show the RMA number on all packages shipped. Packages, which are not marked with an RMA number will be refused at the factory and returned to you **COD**.

Carefully pack the equipment for shipment. Use the original packing material whenever possible

1.7 Limited Warranty

All Products sold or licensed by Honeywell Integrated Security include a **warranty registration card** which must be completed and returned to Honeywell Integrated Security by or on behalf of the end user for Honeywell Integrated Security to provide warranty service, repair, credit or exchange. All warranty work shall be handled through Customer which shall notify Honeywell Integrated Security and apply for a Return Merchandise Authorization (RMA) number prior to returning any Product for service, repair, credit or exchange. Honeywell Integrated Security warrants that its Products shall be free from defects in materials and workmanship for a period of two years from the date of shipment of the Product to Customer. The warranty on Terminals, Printers, Communications Products and Upgrade kits is 90 days from the date of shipment. Satisfaction of this warranty shall be limited to repair or replacement of Products which are defective or defective under normal use. Honeywell Integrated Security's warranty shall not extend to any Product which, upon examination, is determined to be defective as a result of misuse, improper storage, incorrect installation, operation or maintenance, alteration, modification, accident or unusual deterioration of the Product due to physical environments in excess of the limits set forth in Product manuals. THERE ARE NO WARRANTIES WHICH EXTEND BEYOND THIS PROVISION. THIS WARRANTY IS IN LIEU OF ALL OTHER WARRANTIES WHETHER EXPRESS, IMPLIED OR STATUTORY, INCLUDING IMPLIED WARRANTIES OF MERCHANTABILITY OR FITNESS FOR ANY PARTICULAR PURPOSE. NO REPRESENTATION OR WARRANTY OF THE DISTRIBUTOR SHALL EXTEND THE LIABILITY OR RESPONSIBILITY OF THE MANUFACTURER BEYOND THE TERMS OF THIS PROVISION. IN NO EVENT SHALL HONEYWELL INTEGRATED SECURITY BE LIABLE FOR ANY RE-PROCUREMENT COSTS, LOSS OF PROFITS, LOSS OF USE, INCIDENTAL, CONSEQUENTIAL OR SPECIAL DAMAGES TO ANY PERSON RESULTING FROM THE USE OF HONEYWELL INTEGRATED SECURITY'S PRODUCTS.

1.8 Confidentiality

All software, drawings, diagrams, specifications, catalogs, literature, manuals and other materials furnished by Honeywell Integrated Security relating to the design, use and service of the Products shall remain confidential and shall constitute the proprietary rights of Honeywell Integrated Security and Customer agrees to treat such information as confidential. Customer shall acquire no rights in the design of the Products or the related materials except to use such information solely for the purpose of and only during the time it sells the Products.

Customer shall not copy the design of any of the Products or use or cause to be used any Product design or related materials for its own benefit or for the benefit of any other party. The covenants contained in this section shall remain effective throughout the term of this Agreement and thereafter unless specifically waived by Honeywell Integrated Security in writing.

2 Product Overview

The Intelligent Controller is the heart of the PW-6000 and provides the real time processing for the connected I/O interfaces.

The PW-6000 is designed to operate without the need for a PC. It can be connected to a Pro-Watch host computer using direct serial communication, dial-up modem, or TCP/IP network connection. The PW-6000 holds the database for the subsystem configuration and card holders, and the event log buffer, which is in battery-backed memory.



Note: Please refer to the *Pro-Watch Software Suite Guide* for details on using the Pro-Watch interface.

2.1 PW-6000 and PW-5000

- The PW-6000 controller configuration and operation is similar to the PW-5000 controller; both use the Pro-Watch at the front end.
- You can use the PW-5000 controller interface to configure the PW-6000 hardware settings.

2.2 Port Settings

- **Port 0** provides the host-embedded Ethernet interface.
- **Port 1** is for RS-232 or RS-485 2-wire serial interface connections. An optional Lantronix CoBox-Micro interface daughter board (10Base-T/100Base-TX) is also supported on Port 1.
- **Ports 2 and 3** are for RS-485 2-wire downstream support for connecting 32 I/O devices. Note that the I/O communications must be mapped differently in Pro-Watch, according to the following table:

PW-6000 Port	Pro-Watch Port
2	4
3	6

See Table 1 '[PW-6000 Jumper Settings](#)' on page 8 for more information on how to configure the port settings.

2.3 Other

- An on-board real time clock maintains the date and time, taking into account leap year and accounting for global time zones and daylight savings time changes.
- The database for the system configuration and card holders are stored in FLASH memory.
- The event log buffer is stored in battery-backed memory.
- Configuration data and event/status reports are communicated to the host via on-board 10-BaseT/100Base-TX Ethernet port or Port 1.
- Transactions are stored in 1 MB of battery-backed SRAM. The maximum number of transactions stored while the host is offline is 50,000.
- Cards are stored in Flash memory and read into DRAM when the board is powered up. The amount of storage available for cards and biometric records is 15 MB. The maximum number of cards depends on the card record database configuration, but the number is approximately 300,000. This maximum is dependent on how the card is configured with more space per card used with longer card number, more clearance codes, and so on.

Figure 1: PW-6000 Connections, LEDs, and DIP Switches

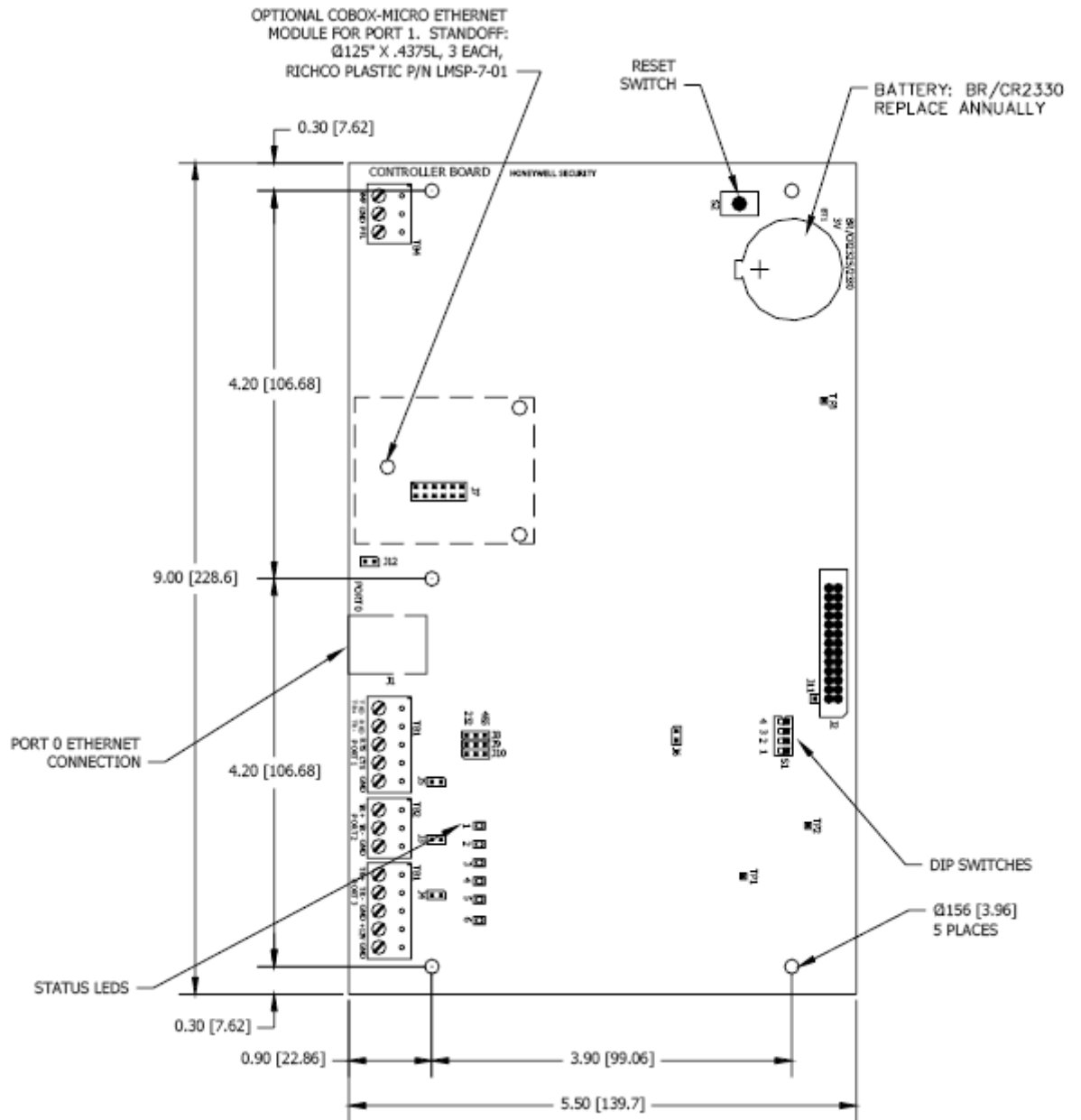

3 Setting Up the PW-6000 Hardware

The PW-6000 processor is configured with 12 jumpers and a set of 4 DIP switches. These jumpers/switches set up the port interface, end of line termination, and operating mode configuration. Refer to the tables below to set the jumpers as required.

3.1 Setting the Jumpers

Table 1 PW-6000 Jumper Settings

Jumpers	Set At	Description
J1	N/A	10Base-T/100Base-TX Ethernet Connection (Port 0)
J2	N/A	Factory Use Only
J3	OFF	Port 2 RS-485 EOL Terminator is OFF
	ON	Port 2 RS-485 EOL Terminator is ON
J4	OFF	Port 3 RS-485 EOL Terminator is OFF
	ON	Port 3 RS-485 EOL Terminator is ON
J5	OFF	Port 1 RS-485 EOL Terminator is OFF
	ON	Port 1 RS-485 EOL Terminator is ON
J6	N/A	Factory Use Only
J7	N/A	COBOX-MICRO Ethernet Module Connection (Port 1)
J8, J9, J10	232	Port 1 is RS-232
	485	Port 1 is RS-485
J11	N/A	Factory Use Only
J12	N/A	Factory Use Only

3.2 Setting the DIP Switches

Dual In-line Package (DIP) switches are read when the system powers up, except where noted otherwise. The following table shows the setting options.

Table 2 PW-6000 DIP Switch Settings

S1	S2	S3	S4	Selection
OFF	OFF	OFF	OFF	Normal Operating Mode.
ON	OFF	OFF	OFF	When DIP switch 1 is ON, Port 0 communicates with the web browser. Port 1 is used for RS-232/485 communications. After the panel initialization, enable the default user name (admin) and password (password). The user name and password are read dynamically; you do not need to reboot the panel.
OFF	ON	OFF	OFF	Use the factory default communication parameters.
ON	ON	OFF	OFF	Unless the network administrator reserves an IP address for the panel (based on the controller board's Media Access Control (MAC) address), the PW-6000 uses Dynamic Host Configuration Protocol (DHCP) to obtain an IP address from the network DHCP server. When power is applied with the switches in this position, there is a ten second window (when LEDs 1 and 2 flash alternately with LEDs 3 and 4), during which memory is cleared if switch 1 or switch 2 is changed to OFF. When switch 1 or 2 is changed to OFF, only LED 2 flashes and memory begins to be cleared. This period of clearing lasts several minutes. When the memory has been cleared, the LED pattern changes to the flashing of LEDs 1 and 4. The panel then reboots by itself. All data in memory is erased except the serial number, MAC address, hardware revision, and OEM code.

The PW-6000 DIP switches need to be set twice:

1. Configure the **S4-S3-S2-S1** DIP switches to **off-off-on-off** to set the default TCP/IP address to 192.168.0.251.
2. Apply power to the panel to set the IP address.
3. Change the **S4-S3-S2-S1** combination to **off-off-off-on**. (DIP switch 1 is “read on the fly”). This sets the login to the default user ID (“admin”) and password (“password”) for Ethernet communications.
4. Create users. See '[User Configuration](#)' on page 23 for instructions.
5. Set the **S4-S3-S2-S1** combination to **off-off-off-off**.
6. Configure the host port for TCP/IP and/or Serial communications. See '[Host Port](#)' on page 18 for instructions. This will enable both TCP/IP and serial hardware networking when you log in again.

3.3 Technical Specifications

Table 3 PW-6000 Technical Specifications

Category	Description
	WARNING: PW-6000 is manufactured for use in low-voltage, Class 2 circuits only.
Primary Power	12Vdc \pm 10%, 300mA maximum. 12Vdc @ 240mA (325mA with CoBox-Micro) nominal.
Memory and Clock Backup	3Volts Lithium, type BR2325, BR2330, CR2330.
Ports	<p>Port 0 10Base-T/100Base-TX Ethernet.</p> <p>Port 1 RS-232 or 2-wire RS-485: 9,600 to 115,200 bps, async. An optional Lantronix CoBox-Micro interface daughter board is supported (10Base-T/100Base-TX).</p> <p>Port 2 & 3 2-wire RS-485: 2,400 to 38,400 bps, async.</p>
Inputs	2 non-supervised, dedicated for cabinet tamper and power fault monitoring.
Cable requirements	<p>Power: 1 twisted pair, 18 AWG.</p> <p>RS-485: 24AWG, 4,000ft (1,200m) maximum, twisted pair with shield. 120 ohm.</p> <p>RS-232: 24AWG, 25ft (7.6m) maximum.</p> <p>Ethernet: Cat 5.</p> <p>Alarm input: 1 twisted pair, 30 ohms maximum.</p>
Environmental	<p>Temperature: 0 to 50°C, operating -55 to +85°C, storage</p> <p>Humidity: 0 to 95% RHNC</p>
Mechanical	<p>Dimensions: 5.5 in. (137.7mm) W x 9 in. (228.6.4mm) L x .75 in. (19.05mm) H</p> <p>Weight: 7.1 oz. (201 gm) nominal</p>
Lantronix NIC support	<p>Standoff size Diameter 0.125 inch x 0.4375 inch long</p> <p>Richco Plastics part number LMSP-7-01, 3 pieces (not supplied)</p>
Specifications subject to change without notice.	



Caution: Locate the power source as close to this board as possible. Connect power with minimum of 18AWG wires.



Note: POLARITY for 12 VDC power is important. Make sure the +12 VDC is connected to the terminal labeled +12V and the return is connected to the terminal labeled GND.

3.4 Status LEDs

The PW-6000 uses six on-board LEDs to provide status information during its initialization sequence and normal run-time operation.

Initialization

Table 4 PW-6000 Status LED Combinations During Initialization

LED 1	LED 2	LED 3	LED 4	LED 5	LED 6	Description
ON	OFF	OFF	OFF	OFF	OFF	Basic processor initialization
ON	ON	OFF	OFF	OFF	OFF	Internal SRAM test
ON	OFF	ON	OFF	OFF	OFF	External SDRAM, First Chip
ON	ON	ON	OFF	OFF	OFF	External FLASH Test
ON	OFF	OFF	ON	OFF	OFF	External SDRAM, Second
ON	ON	OFF	ON	OFF	OFF	External SRAM Test
ON	OFF	ON	ON	OFF	OFF	External EEPROM Test
ON	ON	ON	ON	OFF	OFF	External RTC Test
ON	OFF	OFF	OFF	ON	OFF	Backup Battery and Reset
ON	ON	OFF	OFF	ON	OFF	UART Test
ON	OFF	ON	OFF	ON	OFF	Ethernet Interface, MII
OFF	ON	X	X	X	X	Final processor Initialization

Run Time Supplying Power to the PW-6000 Interface

Table 5 PW-6000 Status LED Combinations During Run Time

LED	Description
1	Off-Line / On-Line and Battery Status
	Off-Line = 20% On, ON-Line = 80% On
	Double Flash means the Battery is Low
2	Primary Host Communication Activity (Ethernet or Port 1)
3	Port 2 Communication Activity
4	Port 3 Communication Activity
5	ON = Writing to Flash Memory. Do NOT cut off power when this LED is ON.
6	TBD
SPD	On-Board Ethernet Speed. OFF = 10MBS. ON = 100MBS.
ACT	OFF = No On-Board Ethernet Activity. ON = On-Board Ethernet Activity (YELLOW LED).
LNK	OFF = ON Link. ON = Good Link (GREEN LED).

3.5 Supplying Power to the PW-6000 Interface

The processor accepts 12Vdc for power. Locate power source as close to the unit as possible and connect it with minimum of 18AWG wires.



Caution: Observe POLARITY on 12 VDC.

Figure 2: PW-6000 Power Terminals

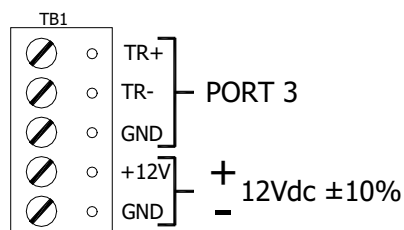

3.6 Communications Wiring

The PW-6000 processor communicates to the host via on-board Ethernet 10Base-T/100Base-TX port or on port 1. Port 1 may be configured as RS-232, two-wire RS-485 or optional Lantronix Ethernet 10Base-T/ 100Base-TX CoBox-Micro interface. The RS-232 interface is for direct one to one connection to a host computer, or a modem.

Ports 2 and 3 use the two-wire RS-485 interface only. The interface allows multi-drop communication on a single bus of up to 4,000 feet (1,200 meters). Use shielded twisted pair (minimum 24 AWG) with 120-ohm impedance. Install termination jumpers only at the end-of-line unit.

Figure 3: PW-6000 Port Wiring

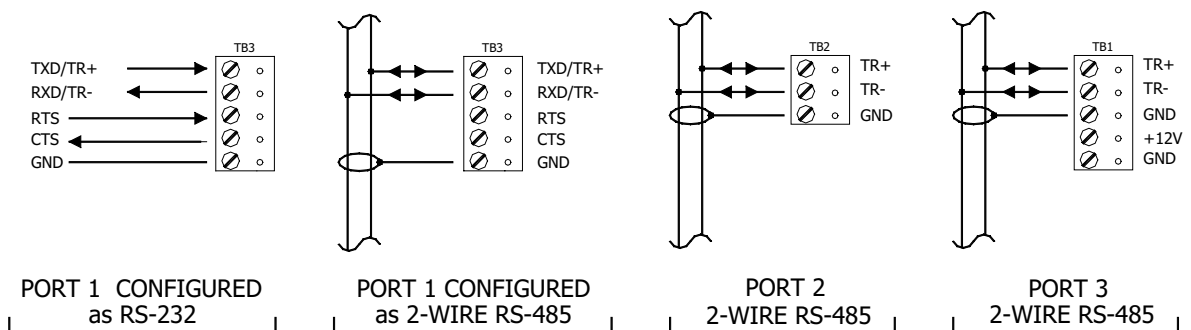

3.7 Cabinet Tamper and Power Failure Input Wiring

Figure 4: PW-6000 TMP and FLT Terminals

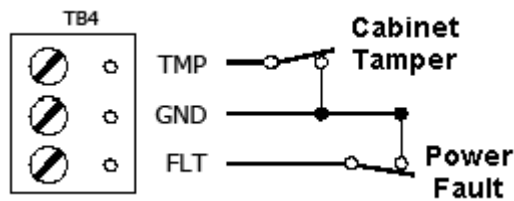

Inputs TMP and FLT are used for monitoring cabinet tamper and power failure with normally closed contacts. These two inputs are for contact closure monitoring only; do not use end-of-line (EOL) resistor(s). If these inputs are not used, install a short piece of wire at the input to indicate a safe condition.

3.8 Memory and Real Time Clock Backup Battery

The event log buffer and the real time clock are backed up by a 3V lithium battery. This BR2325, BR2330, or CR2330 battery should be replaced annually.

4 System Configuration via Web Interface

The PW-6000 comes with **Access Control Device Server Manager (ACDSM)**. The ACDSM is a built-in web server, through which you can configure network and other system settings.



Notes:

- If you are using Internet Explorer Enhanced Security Configuration, you cannot access the ACDSM web server. All pages will display “Bad Request!” You must uninstall the Enhanced Security option before you can access the ACDSM.
- The default factory-set TCP/IP address for the built-in system configuration web server is **192.168.0.251**

4.1 Connecting to ACDSM for the First Time

1. Use the factory default controller IP address **192.168.0.251**.
2. Set the DIP switches to **S4=OFF, S3=OFF, S2=ON, S1=OFF**.



Note: S1 must be set to OFF for the factory default. After the panel powers up, change S1 to ON to enable the use of the default user name and password.

3. Connect the computer to host the web server via Ethernet **Port 0**. Connection should be via crossover Ethernet cable or by the regular Ethernet cables connected via the hub.
4. Set the host computer to the static IP address **192.168.0.250** to be able to connect to the factory-default PW-6000 controller at address **192.168.0.251**.
5. Power up the PW-6000 controller.

4.2 Login Page

1. Click the “**Click Here to Login**” link to display the **User Name** and **Password** fields.

Figure 5: PW-6000 Web Server Login Screen



2. Enter your **User Name** and **Password**.



Note: Default User ID is **admin** and the default Password is **password**.

4.3 Home Page

The first screen after the login is the home page which displays all the available configuration links on the left navigation bar:

Figure 6: PW-6000 Web Server Home Page

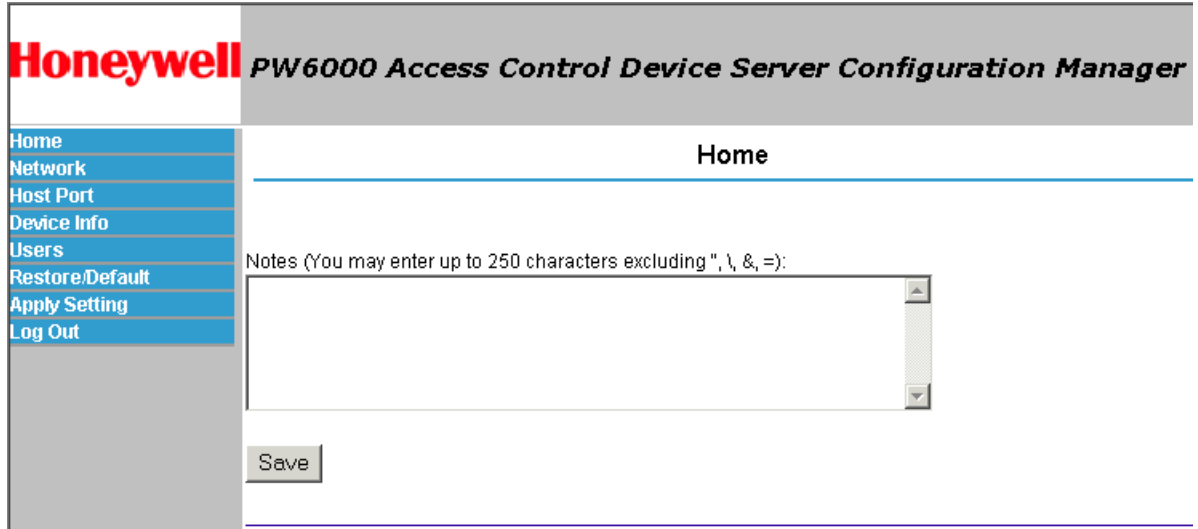

4.4 Network Settings

Click the **Network** link on the navigation bar to display the Network Settings screen where you can select the appropriate option button for dynamic or static IP address configuration:

Figure 7: PW-6000 Web Server Network Settings Screen

Network Settings: IP Configuration

Use DHCP Method to Obtain IP address automatically

Host Name of This Device:

(only 0-9, a-z, A-Z, .(dot), -(hyphen) are allowed)

Use Static IP configuration:

IP Address:

Subnet Mask:

Default Gateway:



Notes:

- The Host Name of This Device field contains the Media Access Control (MAC) address of the PW-6000 controller board.
- The IP address configuration is same as using the Lantronix Ethernet board on a PW-5000. The users can select the **Dynamic IP** option button and reserve an IP address for the MAC address, or they can select the other option button and assign a **Static IP** address as well.

Dynamic IP Configuration Method

1. Click the **Dynamic IP** option button to select the Dynamic Host Configuration Protocol (DHCP) method to obtain IP address automatically.
2. Click **OK**.



Note: The Pro-Watch communicates with the PW-6000 panel using an IP address. If you must use the Dynamic IP option because of your network policies or configuration, you must reserve an IP address at the DHCP server for the MAC (Media Access Control) address in the PW-6000 panel. The MAC address is a unique identifier attached to network adapters. Each time the PW-6000 panel requests an IP address, the DHCP server will assign the address that was reserved for it.

Static IP Configuration Method

1. Click the **Static IP** option button to assign a static IP address, and enter the following information in the appropriate fields:
 - IP Address
 - Subnet Mask
 - Default Gateway
2. Click **OK**.

4.5 Host Port

Click the **Host Port** link on the navigation bar to display the Host Connection Configuration screen where you can select the appropriate settings for the Primary Host Port and Alternate Host Port:



Note: Some of the fields change dynamically depending on the Connection Type selected.

IP Server Connection Type

Figure 8: PW-6000 Host Port Configuration Screen with IP Server Connection

Host Connections Configuration

PW6000 Communication Address:

Primary Host Port

Connection Type: Data Security:

Port Number:

Allow All Authorized IP Address Required

Authorized IP Address:

Alternate Host Port

Connection Type: Data Security:

Baud Rate: Flow Control:

1. From PW6000 Communication Address drop-down list, select one of the eight (0 to 7) available **communication addresses** for the PW-6000 board.



Note: In the previous panels, this selection was made manually by setting the DIP switches.

2. For the **Primary Host Port**, make the following selections:
 - a. **Connection Type.** Select **IP Server** (the standard connection type), so that the Pro-Watch Host will poll the PW-6000 panel. The panel does not currently support the **IP Client** option, which would cause the PW-6000 panel to poll the Pro-Watch Host and the Host to reply to the panel.
 - a. **Data Security.** Select one of the following:
 - **None**
 - **Password/AES** from the drop-down list. If you select **Password/AES**, communications between the Pro-Watch Host and the PW-6000 panel are encrypted. Note that encryption must be enabled in Pro-Watch for the appropriate Pro-Watch channel. See Chapter 7, “Hardware Configuration,” in the *Pro-Watch Guide* for channel encryption instructions.
 - b. **Port Number.** Enter the port number through which the host computer can communicate with the PW-6000 board.
 - c. Select either **Allow All** or the **Authorized IP Address Required** option button.
 - **Allow All**, as the label suggests, allows all IP addresses to communicate with the PW-6000. Select this option for web page browser access.
 - If you select the **Authorized IP Address Required** option, also enter in the **Authorized IP Addresses** fields all the IP addresses that would be allowed to communicate with the PW-6000. Use this option only for Host communication.
3. For the **Alternate Host Port**, make the following selections:
 - a. **Connection Type.** Select one of the following values from the drop-down list: **IP Server**, **Serial-RS232**, **Serial-RS485**, **Serial-Modem**, **Serial-CoBox**. Note that the **IPClient** option is listed, but it is not supported by the panel and should not be selected.
 - b. **Data Security.** Select one of the following values from the drop-down list: **None**, **Password/no AES**, **Password/AES**.
 - c. Select a **Baud Rate** from the drop-down list.
 - d. Select a **Flow Control** from the drop-down list.
4. Click **OK**.

IP Client Connection Type

Figure 9: PW-6000 Host Port Configuration Screen with IP Client Connection

Host Connections Configuration

PW6000 Communication Address:

Primary Host Port

Connection Type:	<input type="text" value="IP Client"/>	Data Security:	<input type="text" value="None"/>
Host IP:	<input type="text"/>	Port Number:	<input type="text"/>
Connection Mode:	<input type="text" value="Continuous"/>	Retry Interval:	<input type="text" value="5sec"/>

Alternate Host Port

Connection Type:	<input type="text" value="Disabled"/>	Data Security:	<input type="text" value="None"/>
------------------	---------------------------------------	----------------	-----------------------------------



Note: The PW-6000 panel does not currently support an IP Client connection.

Serial-RS232, Serial-RS485, Serial-Modem, or Serial-CoBox Connection Types

Figure 10: PW-6000 Host Port Configuration with Serial RS-232 Connection

Host Connections Configuration

PW6000 Communication Address:

Primary Host Port

Connection Type: Data Security:

Baud Rate: Flow Control:

Alternate Host Port

Connection Type: Data Security:

1. From the PW6000 Communication Address drop-down list, select one of the eight (0 to 7) available **communication addresses** for the PW-6000 board.



Note: In the previous panels, this selection was made through setting the virtual DIP switches.

2. For the **Primary Host Port**, make the following selections:
 - a. **Connection Type.** From the drop-down list, select Serial-RS232. Select one of the following as appropriate: **Serial-RS232, Serial-RS495, Serial-Modem, Serial-CoBox.**
 - b. **Data Security.** Select one of the following values from the drop-down list: **None, Password/no AES, Password/AES.**
 - c. Select a **Baud Rate** from the drop-down list.
 - d. Select a **Flow Control** from the drop-down list.

3. For the **Alternate Host Port**, make the following selections:
 - a. **Connection Type**. If you choose to configure an alternate host port, and if you have selected Serial-RS232 for the primary host port, select **IP Server** from the drop-down list for the alternate host port.
 - b. **Data Security**. Select one of the following values from the drop-down list: **None, Password/no AES, Password/AES**.
 - c. Select a **Baud Rate** from the drop-down list.
 - d. Select a **Flow Control** from the drop-down list.
4. Click **OK**.

4.6 Device Information

Click the **Device Info** link on the navigation bar to display the read-only Access Control Device Hardware Information screen:

Figure 11: PW-6000 Web Server Device HW Info Screen

Access Control Device Hardware Info	
Product ID-Version: 40-8	Firmware Revision: 1.1.8
Serial Number: 0000001	OEM Code: Not Loaded
Hardware ID-Revision: 122-0	CPU: 59MHz Part ID-0x20 Part Revision-1
Ethernet: 10/100 Mbps MAC 00:0F:E5:00:00:00	Host Name of This Device: MAC000FE5000000
Memory: 1 MB of SRAM, 32 MB of SDRAM Flash ID 0x8978456 16 MB of Flash	I2C Bus Devices: RTC is present 256 Byte of EEPROM
Ports: 3 serial ports	Battery: Low
Dip Switch: 1 2 3 4 OFF OFF OFF OFF	
Time: - Local Time: 02-04-2022 Friday 06:58:38 - GMT Time: 02-04-2007 Friday 10:58:38 (+0)	

4.7 User Configuration

Click the **Users** link on the navigation bar to display the User screen where you can add, edit, and delete user records:

Figure 12: PW-6000 Web Server User Info Screen

User

Username	Level	Notes
<input type="checkbox"/> pw6k	1	
<input type="checkbox"/> admin	1	
<input type="checkbox"/> macyt	1	
<input type="checkbox"/> rolandm	2	intern
<input type="checkbox"/> forrestl	1	contractor
<input type="checkbox"/> listerp	1	tech support

EditDeleteNew Account

Session Timer

▼ Save Session Timer

Disable Auto-Save

Enable Auto-Save ▼ Save Auto-Save Timer

Adding a User

Follow these steps:

1. Click **New Account** to display the new user account screen.
2. Enter the following:
 - User name – a unique character string that identifies the user.
 - Level – level of privileges the user will have. Level 1 grants the user read/write privileges to all panel features; level 2 grants the user read-only privileges to the Notes, Network, Host Port, and Device Info features; level 3 grants the user read-only privileges to just the Notes and Device Info features.

3. Specify the maximum period of time a session will remain open without user activity. If the period expires without user activity, the user is logged out. After specifying the time period, click **Save Session Timer** to save the setting.
4. Configure the auto-save timer. This feature, if enabled, automatically saves the hardware configuration in non-volatile Random Access Memory (RAM) at the specified time interval. If you select Enable Auto-Save, then select a time interval from the drop-down list, and click **Save Auto-Save Timer** to save the setting.

Editing a User

To edit a user record, click to select the user from the Username column and then click **Edit**. Use the information provided in the previous section, “Adding a User,” to edit the record.

Deleting a User

To delete a user record, click to select the user from the Username column and then click **Delete**.

4.8 Restore Default Screen

Click the **Restore Default** link on the navigation bar to restore the default configuration values for the PW-6000:

Figure 13: PW-6000 Web Server Restore Default Screen

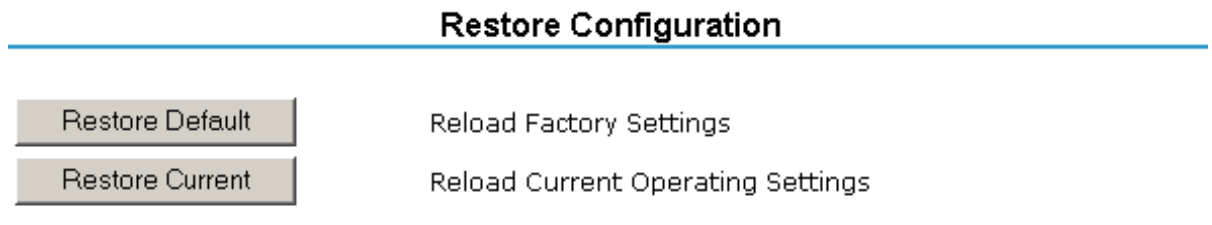

1. Click **Restore Default** to reload the default factory settings for all the configuration variables.
2. Click **Restore Current** to reload the current operational settings for all the configuration variables.

4.9 Apply Setting Screen

Click the **Apply Setting** link on the navigation bar to apply the selected configuration values:

Figure 14: PW-6000 Web Server Apply Setting Screen

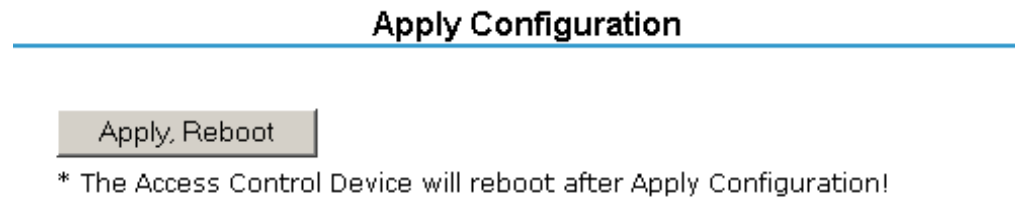

Click **Apply, Reboot** to apply all the configured values and reboot the PW-6000.

4.10 Log Out

Click the **Log Out** link on the navigation bar to log out of the web server.

Appendix A

PW-6000 Web Server and Pro-Watch Channels

The PW-6000 web server's host port configuration requires corresponding changes in the way the Pro-Watch's channels are configured. The PW-6000 web server **host ports** and the Pro-Watch channel **ports** must have the correct values to communicate with each other.

Follow these steps:

1. Set the PW-6000 hardware configuration:
 - a. On the controller board, set the **jumpers J8, J9, J10** on **Port1** to **RS-485**.
 - b. On **Port1**, connect the pins as follows:
 - pin1 = **TR+**
 - pin2 = **TR-**
 - pin5 = **GND** to RS-485 terminals of the Intelligent “Auto” Converter PW5K1CVT1 (i.e., PW-5000 RS-232/RS-485 converter)
 - c. Connect the RS-232 terminal of the PW5K1CVT1 converter to the serial port of your Pro-Watch application server.
2. Set the host port configuration of the PW-6000 web server:
 - a. Login to the Access Control Device Server Configuration Manager.
 - b. Set the **Primary Host** fields as follows:
 - Connection Type = **IP Server**
 - Port Number = **3001**
 - Data Security = **Allow All**
 - c. Set the **Alternate Host Port** fields as follows:
 - Connection Type = **Serial-RS-485**
 - Baud Rate = **38400**
 - Data Security = **None**
 - Flow Control = **RTS Toggle**

-
- d. Click **OK**.
 - e. From the **Setting** menu, select **Apply, Reboot**. The system will display the “Board is Restarting” message.
3. Set the port configuration for the Pro-Watch channel:
 - a. In Pro-Watch, click **Hardware Configuration** on the left navigation bar.
 - b. Right click on your **Site** to launch the mini pop-up menu.
 - c. Select **New > Channel** to display the **Create a Channel** dialog box.
 - d. Click the **Channel Type** drop-down list and select **PW-5000**. The icon of the newly created PW-5000 channel will display in the right pane.
 - e. Right click on the icon of your PW-5000 channel and select **Properties** to display the **Edit Channel Screen** dialog box.

This screen displays configuration fields for the **Primary Port** (related to the Primary Host on the web server) as well as the **Secondary Port** (related to the Alternate Host Port on the web server).

- f. For both **Primary** and **Secondary** ports, select the appropriate values for the following configuration fields:
 - If the Port Type is **Hard Wired** (related to **Serial-RS485** web server host port), then fill in the following settings:
 - ComPort
 - Baud
 - If the Port Type is **TCP/IP** (related to **IP Server** web server host port), then fill in the following settings:
 - IP Address
 - Port Number



Note: If you are using a modem, and the modem uses a procedure that calls Pro-Watch, then the modem must be the primary port.

For more information: www.honeywellintegrated.com

Honeywell Access Systems

135 W. Forest Hill Avenue
Oak Creek, WI 53154
414-766-1700
414-766-1798 Fax

European Office

Boblingerstrasse 17
D-71101 Schonaich
Germany
49-7031-637-782
49-7031-637-769 Fax
www.honeywell.com

Specifications subject to change
without notice.

© Honeywell. All rights reserved.
800-00005, Revision A

Honeywell

Free Manuals Download Website

<http://myh66.com>

<http://usermanuals.us>

<http://www.somanuals.com>

<http://www.4manuals.cc>

<http://www.manual-lib.com>

<http://www.404manual.com>

<http://www.luxmanual.com>

<http://aubethermostatmanual.com>

Golf course search by state

<http://golfingnear.com>

Email search by domain

<http://emailbydomain.com>

Auto manuals search

<http://auto.somanuals.com>

TV manuals search

<http://tv.somanuals.com>