

COMPOSITION:

You must be fully aware of all the distinctive features and precautions related to this camera before installing it.

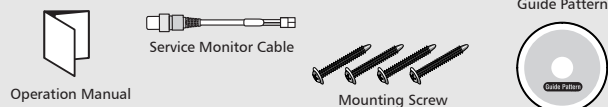

INSTALLATION:

- Stick the guide pattern on the wall or ceiling.
- Drill four holes according to the guide pattern then insert anchors into the drilled holes.
- Draw out power / video wires to the connecting places.
- Fixed the camera to a ceiling using four screws.
- Adjust desired focus and scene by turning and moving the 3-axis camera bracket by hand.
- Put the dome cover over the base.
- Fix the dome cover on the base by covering.

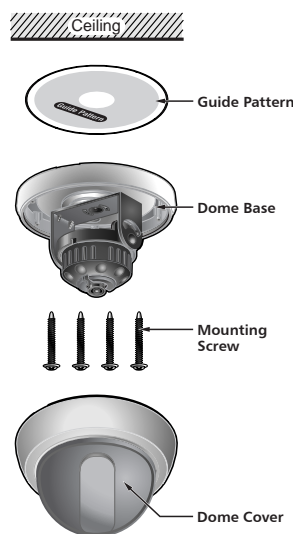

NOTE

Insert coin to the side hole and remove the dome cover by twist coin.

DIMENSIONS(mm):

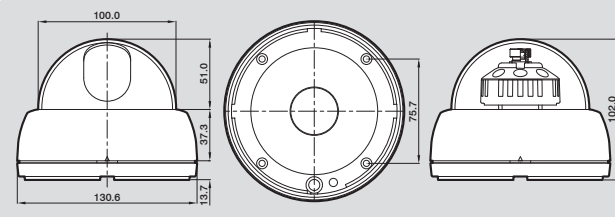

SPECIFICATIONS:

Model	NTSC	PAL
Signal System	NTSC : 525 Lines	PAL : 625 Lines
Scanning System	2 : 1 Interlace	
Scanning Frequency (H)	15.734kHz	15.625kHz
Scanning Frequency (V)	59.94Hz	50Hz
Image Sensor	1/3" SONY Super HAD CCD	
Total / Effective Pixels No.	270K / 250K	320K / 290K
S/N Ratio	More than 48dB (AGC Off)	
Resolution	380 TV Lines	
Video Output Level	1.0 Vp-p (75 Ohms, composite)	
Lens	Fixed Lens : f=4.0mm, 81°	
Focus	Manual	
Sync. System	Internal	
Sensitivity	0 Lux, IR LED	
Electronic Shutter	1/60 ~ 100,000 Sec.	1/50 ~ 100,000 Sec.
White Balance	Auto	
AGC	On / Off	
BLC	On / Off (with Slide Switch)	
Flickerless	On / Off (with Slide Switch)	
Input / Output Connector	Power, Video	
Power Consumption	12VDC (10.8V~15V), 0.4A / 5W (Max)	
Dome Size (Ø)	100mm	
Weight	Approx. 366g	

Need Help?
Call 1.800.796.CCTV for sales, service and customer support.
www.honeywellvideo.com

P/N:3810-0072H Rev.03/18

Honeywell

HD60 Series

Operation Manual



- 1/3" Sony Super HAD CCD
- 380 TV Lines Resolution
- 4mm Fixed Lens
- Color Day/Night with 24 LEDs
- Auto White Balance
- AGC, BLC, Flickerless On/Off
- Extra Video Output for Installer
- 3-Axis Camera Construction
- Diameter of Bubble : 100mm



READ AND KEEP THIS OPERATION MANUAL

PRECAUTIONS:

- Do not install the camera in extreme temperature conditions. Do use the camera under conditions where temperatures are within -10°C to 45°C. Be especially careful with ventilation under high temperatures.
- Do not install or use the camera in an environment where the humidity is high. It can cause the image quality to be poor.
- Do not disassemble the camera. There are no user-serviceable parts inside it.
- Do not drop the camera or subject them to physical shocks. It can cause malfunctions to occur.
- Note
When this camera is installed near wireless communication devices that emits strong electromagnetic field, irregularity such as noise on the monitor may appear.

NAME AND FUNCTION:

Design and specifications are subject to change without notice.

Fixed Lens & IR LED Type

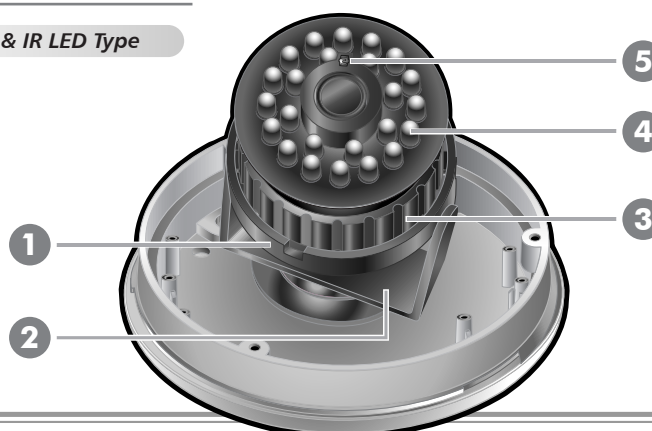

- Tilt rotation: Adjusting the vertical angle.
- Pan rotation: Adjusting the horizontal angle.
- Horizontal rotation: Adjusting the horizontal position of the screen.
- IR LED: 850nm / 30°(24EA)
- Sensor

Camera Lay-out

IR LED (4mm Fixed Lens)

- Power Consumption: 5W
- IR LED Specification: 850nm / 30°(24EA)

CONNECTION:

Connecting to Monitor and Power

12VDC Power Type

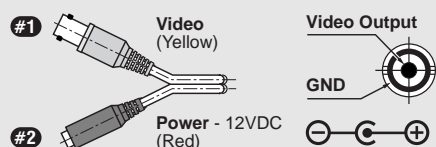

The wire is polarized. Use 12VDC power source.

No.	Function	Terminal Color	Remark
#1	Video Output	Yellow	1.0 Vp-p
#2	Power Input	Red	12VDC(10.8V~15V), 0.4A/5W(Max)

Built-in 3-axis camera bracket makes it much easier to rotate in any direction.

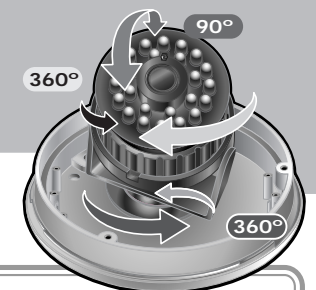

CAMERA SET-UP:

Fixed Lens & IR LED Type

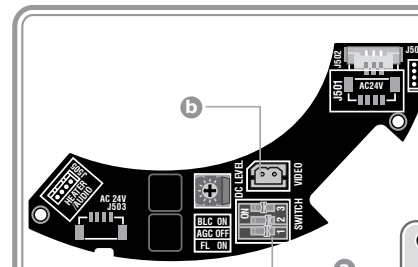

- Function Selection Switch:
 - FL(Flickerless) ON/OFF
 - AGC(Auto Gain Control) ON/OFF
 - BLC(Back Light Compensation) ON/OFF
- Service Monitor Connector: Use service monitor connector to set camera angle & focus when installing.

CAUTION : When AGC is off, D/N does not work because the D/N switching function is dependent on the AGC level.

TROUBLESHOOTING:

If you have trouble operating your camera, refer to the following. If the guidelines do not enable you to solve the problem, contact an authorized technician.

- The image does not appear on the screen.
 - Check the power source for the monitor and camera and ensure that the voltage and polarity are properly connected and being supplied correctly.
- The image on the screen is dim.
 - Check if the lens is stained. If dirty, clean the lens with a soft, clean cloth.
 - Adjust the Back Focus of the lens again.
- The camera does not work properly, the surface of the camera case is hot, and a black line appears on the screen.
 - Check if you have connected the camera to a proper power source and if there is no problem with the power, turn the unit off immediately and seek assistance from our Customer Service department.
- The screen blinks a lot.
 - Check if the camera is pointed toward the sun or a fluorescent lamp.
 - Adjust the angle or location of the camera if too much light is coming into the screen.

Free Manuals Download Website

<http://myh66.com>

<http://usermanuals.us>

<http://www.somanuals.com>

<http://www.4manuals.cc>

<http://www.manual-lib.com>

<http://www.404manual.com>

<http://www.luxmanual.com>

<http://aubethermostatmanual.com>

Golf course search by state

<http://golfingnear.com>

Email search by domain

<http://emailbydomain.com>

Auto manuals search

<http://auto.somanuals.com>

TV manuals search

<http://tv.somanuals.com>