

Honeywell CT8602 PROGRAMMABLE THERMOSTAT

OWNER'S GUIDE

Seven Day
Programmable Heat and/or Cool
Low Voltage (20 to 30 Vac) Thermostat and Wallplate
Model CT8602

Para obtener un documento con las instrucciones en español, por favor visite nuestro sitio de web a: www.honeywell.com/yourhome.
Pour obtenir des notices techniques en français, veuillez consulter notre site web: www.honeywell.com/yourhome.



Table of Contents

Step 1. Prepare for Installation	5
Step 2. Remove Old Thermostat	5
Step 3. Mount Thermostat Wallplate	6
Step 4. Wire Wallplate Terminals	7
Step 5. Install the Batteries	8
Step 6. Set Fan Operation Switch	9
Step 7. Mount the Thermostat	10
Step 8. Customize Your Thermostat	10
Step 9. Set the Clock	14
Step 10. Programming	14
Step 11. Operating Your Thermostat	17
Step 12. Set the Fan and System Switches	19
If You Have a Problem	20
Wiring Diagrams	22



Total comfort temperature management with Smart Response™ Technology

Congratulations! You made a smart choice by purchasing your new Honeywell thermostat; the smart thermostat that:

- *Keeps you comfortable* by automatically calculating exactly when the furnace or air conditioning should go on to have the house at the desired comfort temperature by the time you wake up or return home.
- *Saves the maximum amount of energy and money* by automatically remembering to adjust the temperature when you leave home or go to sleep.
- *Provides the ultimate in comfort and convenience*. It comes preprogrammed. You can use the preprogrammed schedule, or set your own.

This manual answers many of the questions that can arise as you become familiar and comfortable with your Honeywell thermostat — the state of the art in home comfort controls.

Read these instructions carefully. Failure to follow these instructions can damage the product or cause a hazardous condition.



MERCURY NOTICE

If this thermostat is replacing a control that contains mercury in a sealed tube, do not place your old control in the trash. Contact your local waste management authority for instructions regarding recycling and the proper disposal of this control, or of an old control containing mercury in a sealed tube.

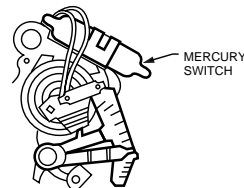

TYPICAL LOCATION OF A MERCURY SWITCH IN A THERMOSTAT

M10614

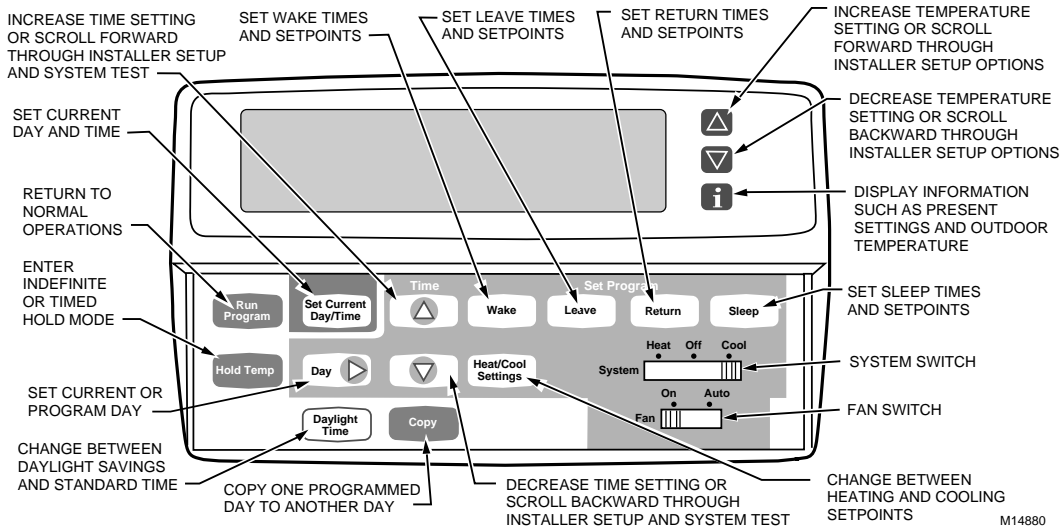

M14880

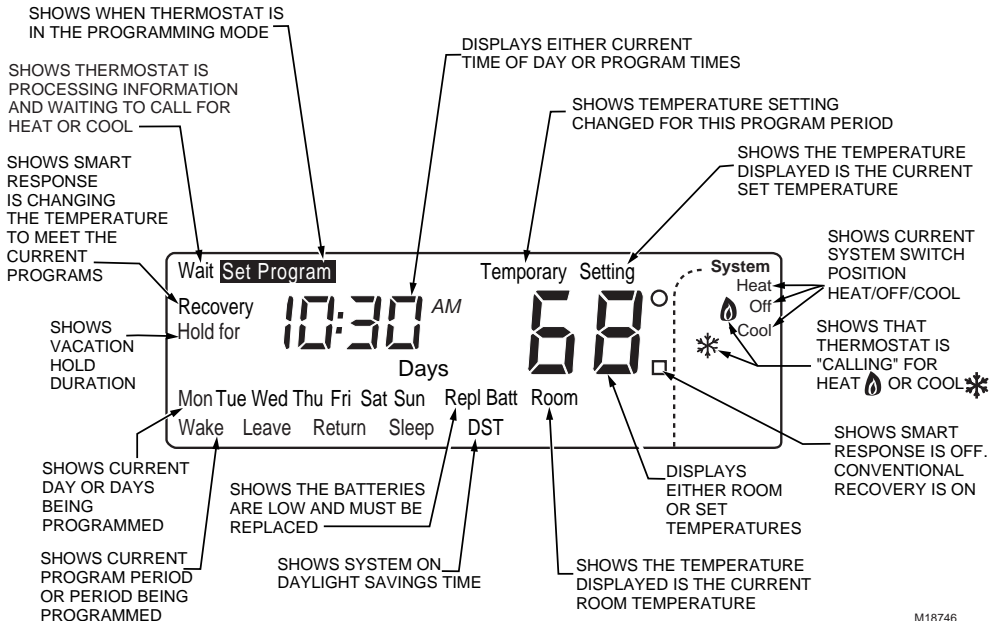

M18746

STEP 1. PREPARE FOR INSTALLATION

- ❑ Check the contents of your thermostat package to be sure all items are included.

Package Contents

- Thermostat
- Wallplate
- Owner's Guide
- Wiring labels
- Screws and anchors

- ❑ Locate the required tools to install your thermostat.

Tools Required

- Screwdriver
- Drill
- Drill bits: 3/16 in. for drywall;
7/32 in. for plaster
- Hammer
- Needle-nose pliers
- Level

STEP 2. REMOVE OLD THERMOSTAT

- ❑ Test your heating and cooling systems to make sure they work properly. If either system does not work, contact your local heating/air-conditioning dealer. To avoid compressor damage, do not operate the cooling system when outdoor temperature is below 50°F (10°C).
- ❑ Turn off power to the system at the furnace or the fuse/circuit breaker panel.
- ❑ Carefully unpack your new thermostat and wallplate. Save package of screws, instructions, and receipt.
- ❑ Remove the cover from the old thermostat. If the cover does not snap off when pulled firmly from the bottom, check for a screw or screws used to lock on the cover.
- ❑ Loosen the screw or screws holding the thermostat to the wallplate and lift the thermostat away.
- ❑ Disconnect the wires from the old thermostat. As you disconnect each wire, attach the enclosed labels with the old terminal designation. If there are only two wires, they do not need to be labeled. Wrap the wires around a pencil as shown to keep them from falling back into the wall.

Special Installations

Read this section if you are replacing:

- Clock thermostat with separate wires for the clock.
- Thermostat with six or more wires connected to it.
- Thermostat in a heating only system with three wires.

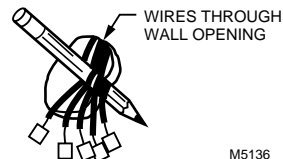

M5136

Replacing a Clock Thermostat that has C or C1 Clock Terminals

When replacing a Honeywell Chronotherm® Thermostat, you may find one or two wires going to the C or C1 clock terminals on the Chronotherm wiring wallplate. Do *not* allow them to touch, or you can damage the transformer. Disconnect the wires and wrap them separately using electrical tape. Do *not* wrap them together. Place the wires where they will not interfere with the operation of the new thermostat. Record the colors and terminal designation labels of the remaining wires.

Replacing a Thermostat that has Six or More Wires

If there are six or more wires (excluding clock wires attached to terminals), you probably have a variation of a multistage heat pump or other multistage system. This thermostat is not compatible with multistage systems, so return the product to the place of purchase. For information about which programmable thermostats will work with your system, call Honeywell Customer Care at 1-800-468-1502.

Replacing a Thermostat that has Three Wires

If you have three wires for a heating only system and can operate the fan using the fan On switch this thermostat works with your system. However, some hot water (zoned) heating systems also have three wires. Your thermostat will work only if you install an isolating relay on these systems. For details, call your local heating and/or cooling contractor.

STEP 3. MOUNT THERMOSTAT WALLPLATE

- ❑ Separate wallplate from thermostat by placing your thumbs between bottom of wallplate and thermostat and pulling wallplate up and away from thermostat. See illustration.
- ❑ Position wallplate on wall. Level wallplate for appearance, if desired. Use a pencil to mark two mounting holes that best fit the application.
- ❑ Remove wallplate from wall. Drill two 3/16 in. holes in wall (if drywall) as shown. For plaster or wood, drill 7/32 in. holes as marked. Gently tap (provided) anchors into drilled holes until flush with wall.
- ❑ Reposition wallplate over holes. Pull wires through wiring opening. Loosely insert mounting screws into each of the holes.
- ❑ Level wallplate, if desired. Thermostat functions correctly, even when not level.
- ❑ Tighten mounting screws.

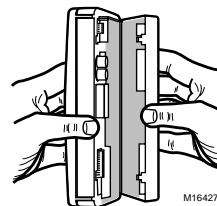
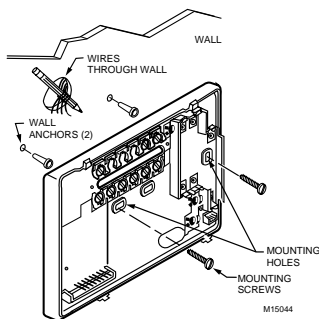

STEP 4. WIRE WALLPLATE TERMINALS

IMPORTANT

All wiring must comply with local codes and ordinances. If unsure about household wiring procedures, call your local heating/air-conditioning contractor.

Refer to the labels you placed on the wires when you removed the old thermostat (see illustration).

- ❑ Match the letter of old thermostat wire with the corresponding terminal letter on new thermostat. Refer to Table 1.
- ❑ Remove factory-installed jumper connecting terminals R and RC if wires are connected to both of those terminals.
- ❑ For wiring diagrams, if needed, see Wiring Diagrams section.
- ❑ Loosen terminal screws. Slip each wire beneath matching terminal. Wraparound and straight connections are both acceptable, (see illustration). Tighten terminals.
- ❑ Plug the hole in the wall with insulation to help prevent drafts from adversely affecting thermostat operation.

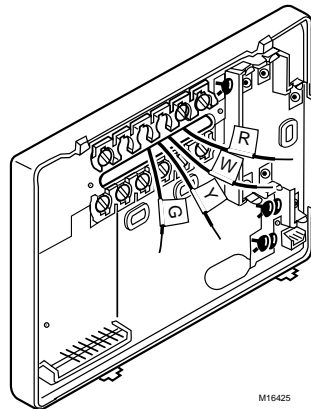

M16425

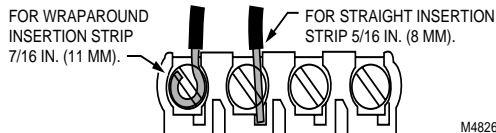

Table 1. Terminal Designations on Old and New Thermostats.

Terminal on Old Thermostat	Connect To	Description
R, RH ^a , 4, V	R	Power
Rc, R ^a	Rc	Power for cooling
W, W ₁ , H	W	Heat
Y, Y ₁ , M	Y	Cooling
G, F	G	Fan
O	O	Changeover in cool. (Single stage heat pump only).
B ^b	B ^b	Changeover in heat. (Single stage heat pump only).
C ^c , X ^c , B ^b	Do not connect.	Transformer common
W ₂ , H ₂	Do not continue installation. Call 1-800-468-1502.	Second stage heat.
Y ₂		Second stage cool.

^a If both RH and R terminals are present on existing thermostat, remove jumper and connect Rh to R and R to Rc.

^b Do not connect both O and B when wiring to a single stage heat pump. Connect O to O. Tape off B.

^c Tape off end of the wire with electrical tape and push the taped wire back into the wiring hole in the wall.

STEP 5. INSTALL THE BATTERIES

IMPORTANT

Three fresh AA alkaline batteries must be installed for programming and operation of the thermostat and the heating/cooling system.

- ❑ Install the batteries in the wallplate so the positive terminals all point up (see illustration).
- ❑ If the thermostat is already mounted on the wall, remove the thermostat by placing your thumb between the thermostat and wallplate and pulling the thermostat up and away as shown on the next page.

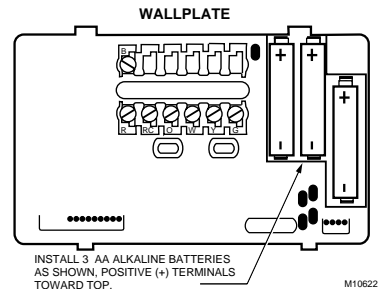

- ❑ When the batteries are running low, a REPL BAT message flashes for one to two months before the batteries run out completely. Replace the batteries as soon as possible once the message flashes.

IMPORTANT

Although the thermostat has a low battery indicator, replace the batteries once per year to prevent leakage and to prevent the thermostat and heating/cooling system from shutting down due to lack of battery power in the thermostat.

- ❑ If you insert new batteries within 20 to 30 seconds of removing the old batteries, the system retains the current time and day. If the display is blank, the batteries are dead or installed incorrectly. You must reset the time and day. Refer to Step 9. Set the Clock for instructions.

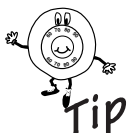
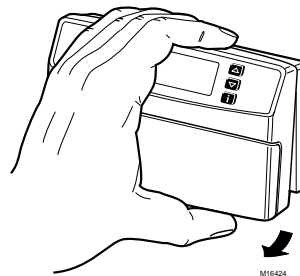

As a precaution when leaving home for longer than a month, change batteries before leaving to prevent the system from shutting down due to lack of power. Always use fresh alkaline batteries. Nonalkaline batteries do not last as long and can leak, causing damage to the thermostat and the wall surface.

STEP 6. SET FAN OPERATION SWITCH

The thermostat fan operation switch, labeled FUEL SWITCH, is factory set in the F position. This is the correct setting for most systems. If your system is an electric heat system, set the switch to E. The E setting allows the fan to turn on immediately with the heating and cooling in a system where the G terminal is connected.

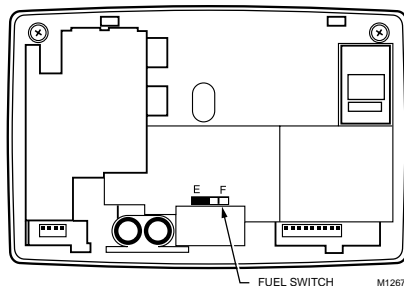

STEP 7. MOUNT THE THERMOSTAT

A. ENGAGE TABS AT TOP OF THERMOSTAT AND WALLPLATE.

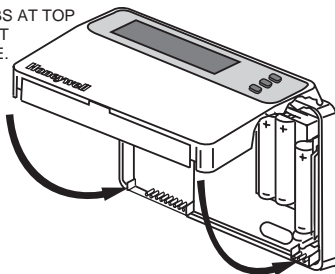

B. PRESS LOWER EDGE OF CASE TO LATCH.

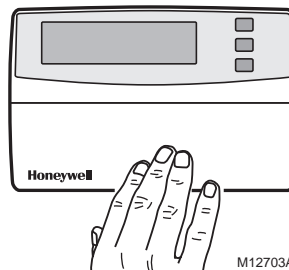

STEP 8. CUSTOMIZE YOUR THERMOSTAT



Your Honeywell CT8602 Thermostat comes preset to the most commonly used settings. The settings are:

- Gas or oil forced air furnace.
- Smart Response Technology on.
- Temperature °F.
- 12-hour clock format.

You can change any or all of these settings.

IMPORTANT

Always press the keys with your fingertip or a similar blunt tool. Sharp instruments like pens and pencil points can damage the keyboard.



- Press and hold down , , and  simultaneously until the display shows two numbers. You now can change any of these settings.

System Type (Feature Number 4)

System type options are:

- 1 = Gravity or steam system.
- 3 = Hot water, high efficiency furnace (90% or better), or single stage heat pump.
- 6 = Gas or oil forced air furnace (preset).
- 9 = Electric furnace.

To change your system type:

- Press  until display shows your furnace or boiler type.
- Press Time  to move to next feature or  to return to main display.

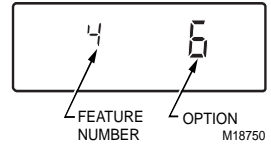

Smart Response™ Technology (Feature Number 13)

Smart Response Technology options are:

- 0 = Smart Response Technology on (preset).
- 1 = Smart Response Technology off.

To turn Smart Response Technology on or off:

- Press  once.
- Press Time  to move to next feature or  to return to main display.

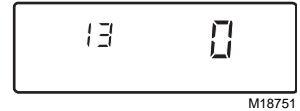

NOTE: See Smart Response Technology section for information about this feature.

Temperature Format (Feature Number 14)

Temperature format options are:

- 0 = °F (preset).
- 1 = °C.

To change temperature format:

- Press  once.
- Press Time  to move to next feature or  to return to main display.

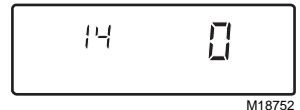

Time Format (Feature Number 16)

Time format options are:

- 0 = 12-hour clock (preset).
- 1 = 24-hour clock.

To change time format:





- Press  once.
- Press Time  to move to next feature or  to return to main display.



M18753

Heating Temperature Range Stops (Feature Number 34)

Temperature range options are:



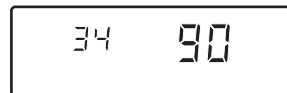

- 90 = highest setting for heating setpoint (preset).
- 40 to 89 = temperature range (1°F increments) of heating setpoint settings.
- Press  or  until the display shows the desired heating temperature range stop.
- Press Time  to move to next feature or  to return to main display.



M18748

Cooling Temperature Range Stops (Feature Number 35)

Temperature range options are:

- 45 = lowest setting for cooling setpoint (preset)
- 46 to 99 = temperature range (1°F increments) of cooling setpoint settings.
- Press  or  until the display shows the desired cooling temperature range stop.
- Press Time  to move to next feature or  to return to main display.



M18749

Factory Set Function (Feature Number 37)

Do not change this setting.

- Press Time  to move to next feature or  to return to main display.

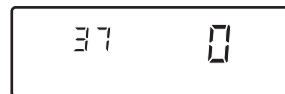



M18754

Furnace Air Filter Timer (Feature No. 43)

Filter timer options:

- 0 = off
- 1 = 30 days
- 2 = 90 days (preset)
- 3 = 180 days
- 4 = 365 days

To change your filter timer:

- Press  until the display shows the desired number of days.
- Press Time  to move to next feature or  to return to main display.

NOTE: The filter time is based on calendar days.

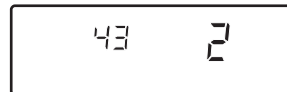



M19600

Humidifier Pad Timer (Feature No. 44)

Humidifier pad timer options:

- 0 = off (preset)
- 1 = 90 days
- 2 = 180 days
- 3 = 365 days

To change your humidifier pad timer:

- Press  until the display shows the desired number of days.
- Press Time  to move to next feature or  to return to main display.

NOTE: The humidifier pad time is based on calendar days. See your humidifier instructions for complete details on replacing and/or cleaning your humidifier pad.

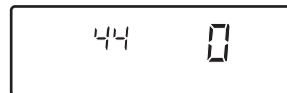



M20246

Ultraviolet (UV) Lamp Timer (Feature No. 45)

UV lamp timer options:

- 0 = off (preset)
- 1 = 365 days

To change your UV lamp timer:

- Press  until the display shows the desired number of days.
- Press Time  to move to next feature or  to return to main display.

NOTE: The UV lamp time is based on calendar days. See your UV lamp instructions for complete details on replacing your UV lamps.

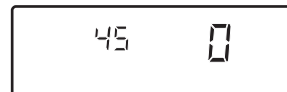







M20247



STEP 9. SET THE CLOCK

Set Current Day and Time





NOTE: On initial power-up, the screen flashes 1:00 pm until you press a key.

- ❑ Press  .
- ❑ Press  until screen shows current day.
- ❑ Press Time  or  until current time shows. (Tapping  advances time in one-hour increments.)
- ❑ Press  until “DST” displays if daylight savings time is in effect.
- ❑ Press  .

STEP 10. PROGRAMMING

The keyboard is located behind the thermostat cover. The three most frequently used keys are near the display. Pressing  displays the current temperature settings. Pressing the  and  keys change the temperature. The thermostat displays day, time, program period, temperature, system and fan settings.

There is an individual key for each of the four program periods:

- —The program period when the house is at a comfortable temperature while you get ready for work or school. (This is a higher temperature during heating season and a lower temperature during cooling season.)
- —The program period you can set for an energy-saving temperature while you are away at work or school. (This is a lower temperature during heating season and a higher temperature during cooling season.)
- —The program period when you want the house at a comfortable temperature for activities before bedtime. (This is a higher temperature during heating season and a lower temperature during cooling season.)
- —The program period you can set for an energy-saving temperature while you are sleeping. (This is a lower temperature during heating season and a higher temperature during cooling season.)

— Table 2 shows the default temperature settings.

Table 2. Default Temperature Settings.





Period	Time	Heating ^a Temperature	Cooling ^b Temperature
Wake	6:00 AM	70°F/21°C	78°F/25.5°C
Leave	8:00 AM	62°F/16.5°C	85°F/29.5°C
Return	6:00 PM	70°F/21°C	78°F/25.5°C
Sleep	10:00 PM	62°F/16.5°C	82°F/28°C

^a Your heating setpoints cannot be higher than 90°F (32°C) or lower than 40°F (4.5°C).

^b Your cooling setpoints cannot be higher than 99°F (37°C) or lower than 45°F (7°C).

Program the First Day

Start by programming the wake time and temperature for one day.

- ❑ Press and release .
- ❑ Press  until the desired day displays (Mon, Tue, Wed, Thu, Fri, Sat, Sun).
- ❑ Press time  or  until the desired time shows in the display.

NOTE: Program times are in 15 minute intervals. For example, 8:00, 8:15, 8:30.

- ❑ Press  or  until the desired wake temperature displays.

The setpoint temperature range is 40°F to 90°F (4.5°C to 32°C) for heating and 45°F to 99°F (7°C to 37°C) for cooling.

- ❑ Press  to switch between setpoints.

NOTE: Program times are the same for heating and cooling.

- Press **▲** or **▼** until the display shows the desired temperature setpoint.
- Press **Leave**, **Return** or **Sleep** and repeat these steps for each program period. The First Day is now programmed.
- Repeat each step in Program the First Day for the rest of the week.

NOTE: After the first day is programmed, you can copy that day to any other day using procedure in Copy a Day.

- Press **Run Program** when the entire week is programmed.

Copy a Day

Your thermostat can copy program settings from one day to another.

- Press **Wake**, **Leave**, **Return** or **Sleep** to enter programming mode.
- Press **Day** until the display shows the day you want to copy.
- Press **Copy**.

- Press **Day** until the display shows the day you want to copy to.

- Press **Copy** to accept the change.
- Repeat these steps for each day you want to copy.

NOTE: donE appears for two seconds and then the normal program display appears.



M13327

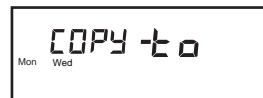









M13328



M13329

Clear a Program Period

NOTE: Wake cannot be cleared.

- Press , , or  for the program period you want to clear.
- Press  until the desired day displays.
- Press and hold , , or  for approximately three seconds until time and temperature clear.
- Repeat the above steps for each period to be cleared.
- Press .





STEP 11. OPERATING YOUR THERMOSTAT

Change Temperature Setting Until the Next Program Period (Temporary Change)

- Press  or  until the screen shows the desired temperature setting.

NOTE: The temporary temperature setting is displayed for about three seconds and then the room temperature is displayed. Temporary appears in the display. The setting cancels when the next program period starts or when you press .

Change Temperature Setting Indefinitely (Hold)

- Move the System switch to the desired position (Heat or Cool).
- Press  then  or  to change your setting if desired. (The display changes from showing the setpoint temperature to room temperature after approximately three seconds.)
- To cancel "Hold" press .

Change the Temperature Setting Until a Designated Day and Period (Vacation Hold)

- ❑ Press **Hold Temp** twice.
- ❑ Press **▲** or **▼** until display shows desired temperature setpoint.
- ❑ Press Time **▲** until the desired number of days that you will be away (1 through 255) is displayed.
- ❑ Press **Wake**, **Leave**, **Return** or **Sleep** to select the program period when you want the program to restart.

NOTE: If Vacation Hold needs to be cancelled before designated time, press **Run Program** to return to the program.

Daylight Savings Time Key

This feature allows you to switch between standard time and daylight savings time.

- ❑ Press **Daylight Time** during fall to set the time back one hour.
- ❑ Press **Daylight Time** in spring to set time forward one hour. DST is displayed when operating on daylight savings time.

NOTE: Pressing Daylight Time key more than once in a five minute period scrolls through various time options. (One hour earlier or later, with or without DST. Pressing the key six times in a five minute period returns you to the original setting.

View or Reset Timer Settings

When the thermostat activates a timer, the thermostat flashes **Filter** until you reset the timer.

- ❑ Reset the timer by pressing the **f** key until the expired timer is displayed.
- ❑ Press the Time **▲** key to reset the timer.
- ❑ Press the **Run Program** key.

NOTE: You can view the number of days remaining at any time by pressing the **f** key three or four times. If more than one timer is active, all active timers show sequentially when pressing the **f** key several times.

For complete instructions on replacing or cleaning your furnace filter, humidifier pad or UV lamp, see the product owner's manuals. Contact your local contractor or visit www.honeywell.com/yourhome.

STEP 12. SET THE FAN AND SYSTEM SWITCHES

First set Fan switch.

Fan On: The fan runs continuously. Use for improved air circulation or for more efficient central air cleaning. (In a heat-only system, fan runs continuously only if fan relay is connected to the G thermostat terminal.)

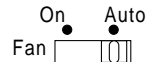

Then set System switch.

Fan Auto: Normal setting for most homes. The equipment controls the fan operation.

Heat: The thermostat controls your heating system.

Off: Both the heating and air conditioning systems are off.

Cool: The thermostat controls your air conditioning system.

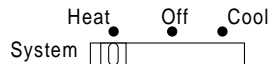

IF YOU HAVE A PROBLEM

Table 3. Solution Guide.



If...	Then...
Display does not appear.	<ul style="list-style-type: none"> • Make sure the batteries are fresh and installed correctly. • Make sure the thermostat is mounted and latched on the wallplate. Mount and latch the thermostat on the wallplate if it is not.
Temperature settings will not change (example; cannot set the heating higher or the cooling lower).	<ul style="list-style-type: none"> • Make sure the temperature setpoints are: 40°F to 90°F (4.5°C to 32°C) for heating. 45°F to 99°F (7°C to 37°C) for cooling. • Check Customize Your Thermostat section, Feature Numbers 34 and 35. Reset as necessary.
Heating does not come on.	<ul style="list-style-type: none"> • Set the system switch to Heat. • Make sure heating setpoint is above room temperature. • Make sure circuit breaker is not tripped, and reset it if necessary. • Make sure power switch at equipment is in On position. • Wait five minutes for the system to respond.
Cooling does not come on.	<ul style="list-style-type: none"> • Set the system switch to Cool. • Make sure the cooling setpoint is below the room temperature. • Make sure the circuit breaker is not tripped, and reset it if necessary. • Make sure System switch at air conditioner is in On position. • Wait five minutes for the system to respond.
System on indicator( = heat,  = cool) is lit, but no warm or cool air is coming from the registers.	Wait five minutes after seeing flame or snowflake and check registers again. If no hot or cool air is coming from registers, refer to Heating does not come on or Cooling does not come on. Or contact your local heating and cooling contractor.
Display flashes during programming.	The temperature setting limit was reached. Heating setting range is 40°F to 90°F (4.5°C to 32°C). Cooling setting range is 45°F to 99°F (7°C to 37°C).

Table 3. Solution Guide.

If...	Then...
Temperature change occurs at the wrong times.	<ul style="list-style-type: none">• Check the program times for the period in question.• Make sure the AM and PM settings are correct.• Make sure the current time and day settings are correct.• Reprogram any incorrect settings. NOTE: If your thermostat is set for Smart Response™ technology, the start times occur before your programmed comfort periods.
Thermostat backlight appears dim.	<ul style="list-style-type: none">• Wait until Replace Battery indicator is illuminated and replace batteries.• Replace batteries now.

Toll-Free Customer Assistance

Please read and follow the instructions for this thermostat. If you have questions about this thermostat, visit our web site at www.honeywell.com/yourhome, or call Honeywell Customer Care at 1-800-468-1502.

WIRING DIAGRAMS

2-WIRE HEAT-ONLY (JUMPER INTACT)

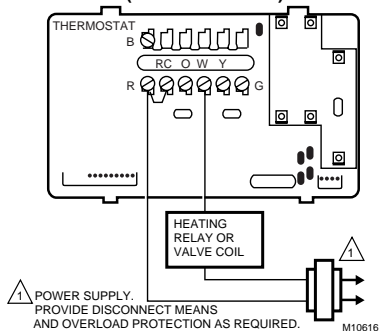

4-WIRE HEAT/COOL (JUMPER INTACT)

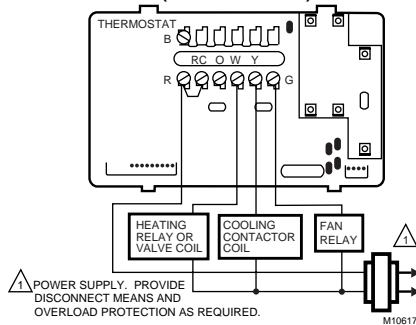

3-WIRE HEAT ONLY WITH FAN (JUMPER INTACT)

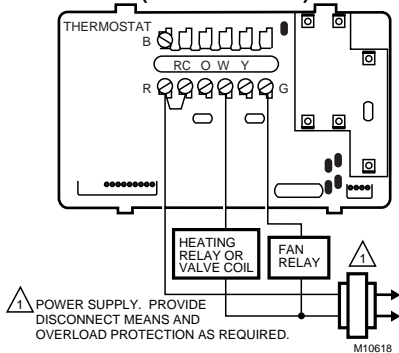

4-WIRE SINGLE-STAGE HEAT PUMP (JUMPER INTACT)

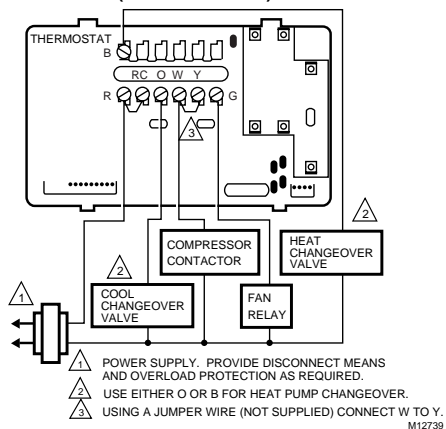

5-WIRE HEAT/COOL (JUMPER REMOVED)

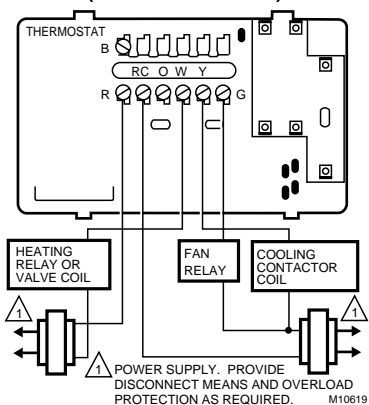

5-WIRE HEAT/COOL WITH DAMPER (JUMPER INTACT)

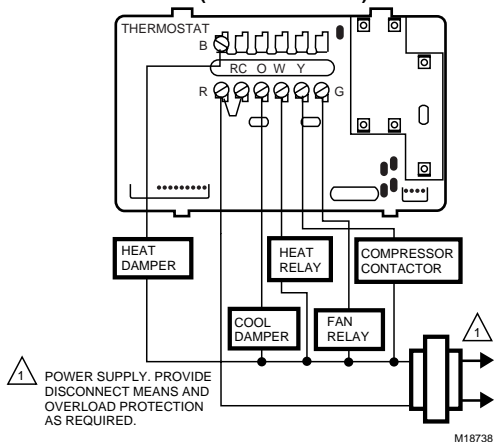

Notice:

This thermostat is a Class B digital apparatus that complies with Canadian Radio Interference Regulations, CRC c. 1374.

Limited One-Year Warranty

Honeywell warrants this product, excluding battery, to be free from defects in the workmanship or materials, under normal use and service, for a period of one (1) year from the date of purchase by the consumer. If, at any time during the warranty period, the product is defective or malfunctions, Honeywell shall repair or replace it (at Honeywells option) within a reasonable period of time.

If the product is defective,

- (i) return it, with a bill of sale or other dated proof of purchase, to the retailer from which you purchased it, or
- (ii) package it carefully, along with proof of purchase (including date of purchase) and a short description of the malfunction, and mail it, postage prepaid, to the following address:

Honeywell International Inc. USA
Dock 4 — MN10-3860
1885 Douglas Drive North
Golden Valley, MN 55422

Honeywell Canada:
Honeywell Limited/Honeywell Limitée
35 Dynamic Drive
Scarborough, Ontario M1V 4Z9

This warranty does not cover removal or reinstallation costs. This warranty shall not apply if it is shown by Honeywell that the defect or malfunction was caused by damage which occurred while the product was in the possession of a consumer.

Honeywell's sole responsibility shall be to repair or replace the product within the terms stated above. HONEYWELL SHALL NOT BE LIABLE FOR ANY LOSS OR DAMAGE OF ANY KIND, INCLUDING ANY INCIDENTAL OR CONSEQUENTIAL DAMAGES RESULTING, DIRECTLY OR INDIRECTLY FROM ANY BREACH OF ANY WARRANTY, EXPRESS OR IMPLIED, OR ANY OTHER FAILURE OF THIS PRODUCT. Some states do not allow the exclusion or limitation of incidental or consequential damages, so this limitation may not apply to you.

THIS WARRANTY IS THE ONLY EXPRESS WARRANTY HONEYWELL MAKES ON THIS PRODUCT. THE DURATION OF ANY IMPLIED WARRANTIES, INCLUDING THE WARRANTIES OF MERCHANTABILITY AND FITNESS FOR A PARTICULAR PURPOSE, IS HEREBY LIMITED TO THE ONE YEAR DURATION OF THIS WARRANTY. Some states do not allow limitations on how long an implied warranty lasts, so the above limitation may not apply to you.

This warranty gives you specific legal rights, and you may have other rights which vary from state to state.

If you have any questions concerning this warranty, please write Honeywell Customer Care, 1885 Douglas Drive North, Golden Valley, MN 55422-3992, or call 1-800-468-1502. In Canada, write Retail Products ON30 Honeywell Limited/Honeywell Limitée, 35 Dynamic Drive, Scarborough, Ontario M1V 4Z9.

Honeywell

Automation and Control Solutions

Honeywell International Inc.	Honeywell Limited-Honeywell Limitée
1985 Douglas Drive North	35 Dynamic Drive
Golden Valley, MN 55422	Scarborough, Ontario
	M1V 4Z9

69-1532—2 J.S. Rev. 3-04



Printed in U.S.A. on recycled
paper containing at least 10%
recycled content.

www.honeywell.com/yourhome

Download from www.Somanuals.com. All Manuals Search And Download.

Free Manuals Download Website

<http://myh66.com>

<http://usermanuals.us>

<http://www.somanuals.com>

<http://www.4manuals.cc>

<http://www.manual-lib.com>

<http://www.404manual.com>

<http://www.luxmanual.com>

<http://aubethermostatmanual.com>

Golf course search by state

<http://golfingnear.com>

Email search by domain

<http://emailbydomain.com>

Auto manuals search

<http://auto.somanuals.com>

TV manuals search

<http://tv.somanuals.com>