

UDC 3300

Universal Digital Controller

Product Manual

51-52-25-55D

4/00

Copyright, Notices, and Trademarks

Printed in U.S.A. – © Copyright 2000 by Honeywell
Revision D – April, 2000

WARRANTY/REMEDY

Honeywell warrants goods of its manufacture as being free of defective materials and faulty workmanship. Contact your local sales office for warranty information. If warranted goods are returned to Honeywell during the period of coverage, Honeywell will repair or replace without charge those items it finds defective. The foregoing is Buyer's sole remedy and is **in lieu of all other warranties, expressed or implied, including those of merchantability and fitness for a particular purpose**. Specifications may change without notice. The information we supply is believed to be accurate and reliable as of this printing. However, we assume no responsibility for its use.

While we provide application assistance personally, through our literature and the Honeywell web site, it is up to the customer to determine the suitability of the product in the application.

Sensing and Control
Honeywell
11 West Spring Street
Freeport, Illinois 61032

About This Document

Abstract

This manual describes the installation, configuration, operation, and maintenance of the UDC3300 Controller.

References

Publication Title	Publication Number
UDC 3300 Limit Controller	51-52-25-56
UDC 3000/UDC 3300/UDC5000/UDC6000U/DC6300 RS422/485 Communications Option Manual	51-51-25-35
UDC 3000/3300 DMCS Communications Option Section of the Gateway Manual	82-50-10-23
Modbus® RTU Serial Communications User Manual	51-52-25-66
Modbus® RTU Serial Communications User Manual Configuration Interface for UDC 3300	51-52-25-70
UDC 3300 Controller Specification Sheet	51-52-03-23
UDC 3000 Modbus 485RTU Communications Option	51-52-25-38
How to Apply Digital Instrumentation in Severe Electrical Noise Environments	51-52-05-01

Contacts

World Wide Web

The following lists Honeywell's World Wide Web sites that will be of interest to our customers.

Honeywell Organization	WWW Address (URL)
Corporate	http://www.honeywell.com
Sensing and Control	http://www.honeywell.com/sensing
International	http://www.honeywell.com/Business/global.asp

Telephone

Contact us by telephone at the numbers listed below.

	Organization	Phone Number
United States and Canada	Honeywell	1-800-423-9883 Tech. Support 1-888-423-9883 Q&A Faxback 1-800-525-7439 (TACFACS) Service
Asia Pacific	Honeywell Asia Pacific Hong Kong	(852) 2829-8298
Europe	Honeywell PACE, Brussels, Belgium	[32-2] 728-2111
Latin America	Honeywell, Sunrise, Florida U.S.A.	(854) 845-2600

Symbol Definitions

The following table lists those symbols used in this document to denote certain conditions.








Symbol	Definition
	This CAUTION symbol on the equipment refers the user to the Product Manual for additional information. This symbol appears next to required information in the manual.
	WARNING PERSONAL INJURY: Risk of electrical shock. This symbol warns the user of a potential shock hazard where HAZARDOUS LIVE voltages greater than 30 Vrms, 42.4 Vpeak, or 60 Vdc may be accessible. Failure to comply with these instructions could result in death or serious injury.
	ATTENTION, Electrostatic Discharge (ESD) hazards. Observe precautions for handling electrostatic sensitive devices
	Protective Earth (PE) terminal. Provided for connection of the protective earth (green or green/yellow) supply system conductor.
	Functional earth terminal. Used for non-safety purposes such as noise immunity improvement. NOTE: This connection shall be bonded to protective earth at the source of supply in accordance with national local electrical code requirements.
	Earth Ground. Functional earth connection. NOTE: This connection shall be bonded to Protective earth at the source of supply in accordance with national and local electrical code requirements.
	Chassis Ground. Identifies a connection to the chassis or frame of the equipment shall be bonded to Protective Earth at the source of supply in accordance with national and local electrical code requirements.

Table of Contents

SECTION 1 – OVERVIEW.....	1
1.1 Introduction.....	1
1.2 Operator Interface	3
SECTION 2 – INSTALLATION.....	7
2.1 Overview.....	7
2.2 Model Number Interpretation.....	12
2.3 Mounting.....	13
2.4 Wiring	15
2.5 Wiring Diagrams	18
2.6 Control and Alarm Relay Contact Information	34
SECTION 3 – CONFIGURATION	35
3.1 Overview.....	35
3.2 Configuration Prompts.....	36
3.3 How To Get Started.....	38
3.4 Configuration Tips	39
3.5 Configuration Procedure.....	40
3.6 Loop 1 Tuning Parameters Set Up Group.....	42
3.7 Loop 2 Tuning Parameters Set Up Group (Cascade or Two Loops.....	44
3.8 SP Ramp, SP Rate, or SP Programming Set Up Group	45
3.9 Accutune Set Up Group.....	47
3.10 Algorithm Data Set Up Group.....	49
3.11 Output Algorithm Parameters Set Up Group.....	53
3.12 Input 1 Parameters Set Up Group.....	54
3.13 Input 2 Parameters Set Up Group.....	56
3.14 Input 3 Parameters Set Up Group.....	57
3.15 Loop 1 Control Parameters Set Up Group	58
3.16 Loop 2 Control Parameters Set Up Group	60
3.17 Options Set Up Group	62
3.18 Communications Set Up Group.....	64
3.19 Alarms Set Up Group	66
3.20 Display Parameters Set Up Group	69
3.21 Calibration Group	70
3.22 Maintenance Set Up Group.....	71
3.23 Status Group	72
3.24 Configuration Record Sheet Basic Model: DC330B-XX-XXX DMCS Model: DC330D-XX-XXX	73
3.25 Configuration Record Sheet Expanded Model: DC330E-XX-XXX	75

SECTION 4 – CONFIGURATION PROMPT DEFINITIONS	79
4.1 Overview	79
4.2 Loop 1 Tuning Parameters Set Up Group.....	80
4.3 Loop 2 Tuning Parameters Set Up Group.....	84
4.4 Setpoint Ramp/Rate/Programming Set Up Group	85
4.5 Accutune Set Up Group	88
4.6 Algorithm Data Set Up Group.....	92
4.7 Output Algorithm Parameters Set Up Group.....	109
4.8 Input 1 Parameters Set Up Group.....	112
4.9 Input 2 Parameters Set Up Group.....	116
4.10 Input 3 Parameters Set Up Group.....	117
4.11 Loop 1 Control Parameters Set Up Group	118
4.12 Loop 2 Control Parameters Set Up Group	124
4.13 Options Set Up Group	129
4.14 Communications Set Up Group.....	135
4.15 Alarms Set Up Group	139
4.16 Display Parameters Set Up Group	143
4.17 Calibration Data.....	144
4.18 Maintenance Group.....	144
4.19 Status Test Data.....	146
SECTION 5 – OPERATION.....	147
5.1 Overview	147
5.2 How to Power Up the Controller.....	148
5.3 Entering a Security Code.....	150
5.4 Monitoring Your Controller	151
5.5 Start-up Procedure	155
5.6 Operating Modes.....	156
5.7 Setpoints.....	160
5.8 Setpoint Ramp Rate	163
5.9 Single Setpoint Ramp.....	164
5.10 Using Two Sets of Tuning Constants	168
5.11 Alarm Setpoints	171
5.12 Two Loops of Control Overview	172
5.13 Configuring Two Loops of Control.....	177
5.14 Monitoring Two Loops of Control	180
5.15 Operating Two Loops of Control	181
5.16 Three Position Step Control Algorithm	182
5.17 Input Math Algorithms.....	183
5.18 Digital Input Option (Remote Switching).....	186
5.19 Auto/Manual Station	190
5.20 Fuzzy Overshoot Suppression	193
5.21 Accutune.....	194
5.22 Carbon Potential.....	202
5.23 HealthWatch	204
SECTION 6 – SETPOINT RAMP/SOAK PROGRAMMING OPTION.....	205
6.1 Overview	205
6.2 Program Contents	206
6.3 Drawing a Ramp/Soak Profile	209
6.4 Entering the Setpoint Program Data	211
6.5 Run/Monitor the Program	214

SECTION 7 – INPUT CALIBRATION	219
7.1 Overview.....	219
7.2 Minimum and Maximum Range Values.....	220
7.3 Preliminary Information.....	221
7.4 Input #1, #2, or #3 Set Up Wiring	223
7.5 Input #1, #2, or #3 Calibration Procedure.....	229
7.6 Restoring Factory Calibration	231
SECTION 8 – OUTPUT CALIBRATION	233
8.1 Overview.....	233
8.2 Current Proportional Output Calibration	234
8.3 Position Proportional and Three Position Step Output Calibration.....	236
8.4 Auxiliary Output Calibration.....	240
SECTION 9 – TROUBLESHOOTING / SERVICE	243
9.1 Overview.....	243
9.2 Troubleshooting Aids.....	245
9.3 Power-up Tests	247
9.4 Status Tests.....	248
9.5 Background Tests.....	250
9.6 Controller Failure Symptoms.....	252
9.7 Troubleshooting Procedures	253
9.8 Parts Replacement Procedures.....	261
9.9 Maintenance	270
SECTION 10 – PARTS LIST	271
10.1 Exploded View.....	271
SECTION 11 – APPENDIX A – MANUAL TUNING.....	273
11.1 Overview.....	273
11.2 Time, Position, or Current Proportional Simplex Control.....	274
11.3 Time Proportional Duplex or Current Proportional Duplex Control.....	276
11.4 Two Sets of Tuning Parameters for Single Output Operation	276

Figures

Figure 1-1	Operator Interface Displays and Indicators	3
Figure 2-1	Model Number Interpretation	12
Figure 2-2	Dimensions	13
Figure 2-3	Mounting Method	14
Figure 2-4	Composite Wiring Diagram	18
Figure 2-5	Line Voltage Wiring	19
Figure 2-6	Input #1/Input #2 Connections	20
Figure 2-7	Two HLAI Replace 2nd LLAJ Connections	21
Figure 2-8	Electromechanical Relay Output—Model DC330X-EE-XXX	22
Figure 2-9	Solid State Relay Output—Model DC330X-AA-XX	23
Figure 2-10	10-amp Solid State Relay Output—Model DC330X-SS-XX	24
Figure 2-11	Open Collector Output—Model DC330X-TT-XXX	25
Figure 2-12	Current Output—Current /Time Duplex, Time/Current Duplex, Position Proportional, or Three Position Step Control	26
Figure 2-13	Auxiliary Output and Three Relay Outputs	27
Figure 2-14	Position Proportional Output or Three Position Step—Models DC330X-EE-XXX-X2, DC330X-AA-XXX-X2	28
Figure 2-15	Auxiliary Output Connections—Models DC330X-XX-2XX, DC330X-XX-5XX	29
Figure 2-16	Digital Inputs Connections—Model DC330X-XX-XX3	29
Figure 2-17	RS422/485/Modbus Communications Option Connections	30
Figure 2-18	DMCS Communications Option Connections	31
Figure 2-19	Transmitter Power for 4-20 mA 2-wire Transmitter Using Open Collector Alarm 2 Output—Model DC330X-XT-XXX	32
Figure 2-20	Transmitter Power for 4-20 mA 2-wire Transmitter Using Auxiliary Output— Model DC330X-XX-2XX or DC330X-XX-5XX	33
Figure 3-1	Overview of UDC 3300 Prompt Hierarchy	36
Figure 4-1	Example of Mass Flow Compensation using Multiplier/Divider Algorithm	102
Figure 4-2	Example of Eight Segment Characterizer	106
Figure 5-1	Operator Interface	151
Figure 5-2	Functional Overview Block Diagram of a Single Loop (Loop #1) or Dual Loop Controller (Loop #1 and Loop #2)	173
Figure 5-3	Functional Overview Block Diagram of Internal Cascade of a 2-loop Controller	174
Figure 5-4	Hi/Lo Override Selector	175
Figure 5-5	Auto/Manual Station and Backup Control Feature	190
Figure 5-6	Carbon Potential Control	203
Figure 6-1	Ramp/Soak Profile Example	209
Figure 6-2	Program Record Sheet	210
Figure 7-1	Inputs #1, #2, and #3 Wiring Terminals	221
Figure 7-2	Wiring Connections for Thermocouple Inputs Using an Ice Bath	223
Figure 7-3	Wiring Connections for Thermocouple Inputs Using a Precision Resistor	224
Figure 7-4	Wiring Connections for RTD	225
Figure 7-5	Wiring Connections for Radiamatic, Millivolts, or Volts (except 0 to 10 Volts)	226
Figure 7-6	Wiring Connections for 0 to 10 Volt Inputs	227
Figure 7-7	Wiring Connections for 4 to 20 mA inputs	228
Figure 8-1	Wiring Connections for Calibrating Current Proportional Output	234
Figure 8-2	Wiring Connections for Calibrating Auxiliary Output	240
Figure 9-1	Chassis Removal	262
Figure 9-2	Display/Keyboard Replacement	263
Figure 9-3	Removing the Printed Wiring Boards	264
Figure 9-4	Printed Wiring Board Identification	265
Figure 10-1	UDC 3300 Exploded View	271

Tables

Table 1-1	Function of Keys.....	4
Table 2-1	Specifications	8
Table 2-2	Procedure for Mounting the Controller	14
Table 2-3	Permissible Wiring Bundling.....	16
Table 2-4	Input 2 Jumper Selections.....	21
Table 2-5	Universal Output Wiring Functionality and Restrictions for Figure 2-12.....	26
Table 2-6	Universal Output Wiring Functionality and Restrictions for Figure 2-13.....	27
Table 2-7	Control Relay Contact Information	34
Table 2-8	Alarm Relay Contact Information	34
Table 3-1	Configuration Tips	39
Table 3-2	Configuration Procedure	40
Table 3-3	Tuning Group Function Prompts	42
Table 3-4	Tuning Loop 2 Group Function	44
Table 3-5	SP Ramp Group Function Prompts.....	45
Table 3-6	Accutune Group Function Prompts	48
Table 3-7	Algorithm Group Function Prompts.....	49
Table 3-8	Output Algorithm Group Function Prompts	53
Table 3-9	Input 1 Group Function Prompts	54
Table 3-10	Input 2 Group Function Prompts	56
Table 3-11	Input 3 Group Function	57
Table 3-12	Control Group Function Prompts	58
Table 3-13	Control 2 Group Function Prompts	60
Table 3-14	Options Group Function Prompts.....	62
Table 3-15	Communications Group Function Prompts	64
Table 3-16	Alarms Group Function Prompts.....	66
Table 3-17	Display Group Function Prompts	69
Table 3-18	Maintenance Group Function Prompts	71
Table 4-1	Tuning Group Prompt Definitions.....	80
Table 4-2	Loop 2 Tuning Group Prompt.....	84
Table 4-3	Setpoint Ramp/Rate Group Definitions	85
Table 4-4	Accutune Group Definitions.....	88
Table 4-5	Algorithm Group Definitions	92
Table 4-6	Output Algorithm Group Definitions	109
Table 4-7	Input 1 Group Definitions	112
Table 4-8	Input 2 Group Definitions	116
Table 4-9	Input 3 Group Definitions	117
Table 4-10	Control Group Definitions.....	118
Table 4-11	Control 2 Group Definitions.....	124
Table 4-12	Options Group Definitions	129
Table 4-13	Communications Group Definitions.....	135
Table 4-14	Alarms Group Definitions	139
Table 4-15	Display Group Definitions.....	143
Table 4-16	Maintenance Group Definitions	144
Table 5-1	Power Up Diagnostic Tests.....	148
Table 5-2	Procedure for Testing the Displays and Keys	149
Table 5-3	Procedure for Entering a Security Code	150
Figure 5-1	Operator Interface.....	151
Table 5-4	Lower Display Key Parameter.....	153

Table 5-5	Error Messages.....	154
Table 5-6	Procedure for Starting Up the Controller.....	155
Table 5-7	Operating Mode Definitions.....	156
Table 5-8	Changing Operating Modes	157
Table 5-9	Procedure for Selecting Automatic or Manual Mode.....	158
Table 5-10	Procedure for Selecting the Local Setpoint Source.....	160
Table 5-11	Procedure for Changing the Local Setpoints	161
Table 5-12	Procedure for Enabling (or Disabling) the Remote Setpoint	162
Table 5-13	Setpoint Selection Indication	162
Table 5-14	Procedure for Configuring a Setpoint Ramp	164
Table 5-15	Procedure for Running a Setpoint Ramp	166
Table 5-16	Procedure for Selecting Two Sets of Tuning Constants	168
Table 5-17	Procedure for Setting Switchover Values.....	169
Table 5-18	Procedure for Setting Tuning Constant Values.....	169
Table 5-19	Procedure for Switching PID SETS from the Keyboard	170
Table 5-20	Procedure for Displaying or Changing the Alarm Setpoints.....	171
Table 5-21	Control Loop Selections	172
Table 5-22	Two-loop Functionality and Restrictions (Model DC330E-EE-2XX or Model DC330E-EE-5XX).....	175
Table 5-23	Two-loop Functionality and Restrictions (Model DC330E-KE-2XX or Model DC330E-KE-5XX).....	176
Table 5-24	Procedure for Selecting 2-loop Algorithm	177
Table 5-25	Procedure for Selecting Output Algorithm.....	177
Table 5-26	Procedure for Selecting Control Parameters	178
Table 5-27	Procedure for Selecting Tuning Parameters	179
Table 5-28	Digital Display Indication—Two Loops.....	180
Table 5-29	Procedure for Displaying the 3PSTEP Motor Position	182
Table 5-30	Digital Input Option Action on Contact Closure.....	186
Table 5-31	Digital Input Combinations “DIG IN1” or “DIG IN2”	188
Table 5-32	Digital Inputs 1 and 2 Combination	189
Table 5-33	Auto/Manual Station Mode Configuration Procedure.....	191
Table 5-34	Accutune Rules and Regulations	195
Table 5-35	Procedure for Starting TUNE (Demand) Tuning	196
Table 5-36	Procedure for Using TUNE at Start-up for Duplex	197
Table 5-37	Procedure for Using SP Tuning at Start-up.....	198
Table 5-38	Procedure for Using SP Tuning at Start-up for Duplex	199
Table 5-39	Accutune* Error Prompt Definitions	201
Table 6-1	Setpoint Program Data Entry Procedure.....	211
Table 6-2	Prompt Hierarchy and Available Selections	212
Table 6-3	Run/Monitor Functions	214
Table 6-4	Procedures for Changing a Running Setpoint Program.....	217
Table 7-1	Voltage and Resistance Equivalents for 0% and 100% Range Values.....	220
Table 7-2	Equipment Needed	222
Table 7-3	Set Up Wiring Procedure for Thermocouple Inputs Using an Ice Bath	223
Table 7-4	Set Up Wiring Procedure for Thermocouple Inputs Using a Precision Resistor	224
Table 7-5	Input #1, #2, or #3 Calibration Procedure	229
Table 7-6	Restoring Factory Calibration.....	231
Table 8-1	Set Up Wiring Procedure Current Proportional Output	234
Table 8-2	Current Proportional Output Calibration Procedure	235
Table 8-3	Position Proportional and 3 Position Step Output Calibration Procedure	237
Table 8-4	Set Up Wiring Procedure for Auxiliary Output.....	240
Table 8-5	Auxiliary Output Calibration Procedure	241
Table 9-1	Error Message Prompts	245

Table 9-2	Procedure for Identifying the Software Version.....	246
Table 9-3	Power-up Tests	247
Table 9-4	Procedure for Displaying the Status Tests Results	248
Table 9-5	Status Tests	249
Table 9-6	Background Tests	250
Table 9-7	Controller Failure Symptoms.....	252
Table 9-8	Troubleshooting Power Failure Symptoms	253
Table 9-9	Troubleshooting Current Proportional Output Failure	254
Table 9-10	Troubleshooting Position Proportional Output Failure.....	255
Table 9-11	Troubleshooting Time Proportional Output Failure	256
Table 9-12	Troubleshooting Time/Current or Current/Time Proportional Output Failure	257
Table 9-13	Troubleshooting Alarm Relay Output Failure	258
Table 9-14	Troubleshooting a Keyboard Failure	259
Table 9-15	Troubleshooting a Communications Failure.....	260
Table 9-16	How to Remove the Chassis.....	262
Table 9-17	Display/Keyboard Assembly Replacement Procedure.....	263
Table 9-18	Printed Wiring Board Removal from Chassis	264
Table 9-19	Second Input Board Replacement Procedure.....	266
Table 9-20	Power Input Board Replacement Procedure.....	266
Table 9-21	Digital Input Board Replacement Procedure	267
Table 9-22	Aux.Out/Communications Board Replacement Procedure	268
Table 9-23	MCU/Output Board Replacement Procedure	269
Table 10-1	Parts Identification.....	272
Table 10-2	Parts Not Shown	272
Table 11-1	Manual Tuning Procedure for Simplex Control	274
Table 11-2	Manual Tuning Formulas	275

Section 1 – Overview

1.1 Introduction

- Function** The UDC 3300 is a microprocessor-based stand alone controller. It combines the highest degree of functionality and operating simplicity offered in a 1/4 DIN size controller. With a typical accuracy of $\pm 0.20\%$ of span, the UDC 3300 is an ideal controller for regulating temperature and other process variables in numerous heating and cooling applications, in metal working, food, and pharmaceuticals, and testing and environmental work.
- Easy to read displays** The dedicated vacuum fluorescent displays with multi-language prompts make the operator interface easy to read, understand and operate. Programmed sequences of displays assure quick and accurate entry of all configurable parameters.
- Easy to operate** Simple keystrokes let you select input and range configuration, set the operating parameters that meet your process control needs now, and change them later to meet new ones. The tactile keyboard provides positive operator feedback. Self diagnostics, fault tolerant design and keyboard security provide maximum assurance of trouble-free operation.
- Mount anywhere** The UDC is industrial control equipment that must be panel mounted. The wiring terminals must be enclosed within the panel. The UDC is environmentally hardened and, when suitably enclosed, can be mounted virtually anywhere in plant or factory; on the wall, in a panel, or even on the process machine. It withstands ambient temperatures up to $55\text{ }^{\circ}\text{C}$ ($133\text{ }^{\circ}\text{F}$) and resists the effects of vibration and mechanical shock.
- CE Conformity (Europe)** This product is in conformity with the protection requirements of the following European Council Directives: **73/23/EEC**, the Low Voltage Directive, and **89/336/EEC**, the EMC Directive. Conformity of this product with any other “CE Mark” Directive(s) shall not be assumed.
- Product Classification:* Class I: Permanently connected, panel-mounted Industrial Control Equipment with protective earthing (grounding). (EN61010-1).
- Enclosure Rating:* Panel-mounted equipment, IP 00. This controller must be panel-mounted. Terminals must be enclosed within the panel. Front panel IP 65 (IEC 529).
- Installation Category (Overvoltage Category):* Category II: Energy-consuming equipment supplied from the fixed installation, local level appliances, and Industrial Control Equipment. (EN61010-1)
- Pollution Degree:* Pollution Degree 2: Normally non-conductive pollution with occasional conductivity caused by condensation. (Ref. IEC 664-1)

EMC Classification: Group 1, Class A, ISM Equipment (EN55011, emissions), Industrial Equipment (EN50082-2, immunity)

Method of EMC Assessment: Technical File (TF)

Declaration of Conformity: 51309602-000

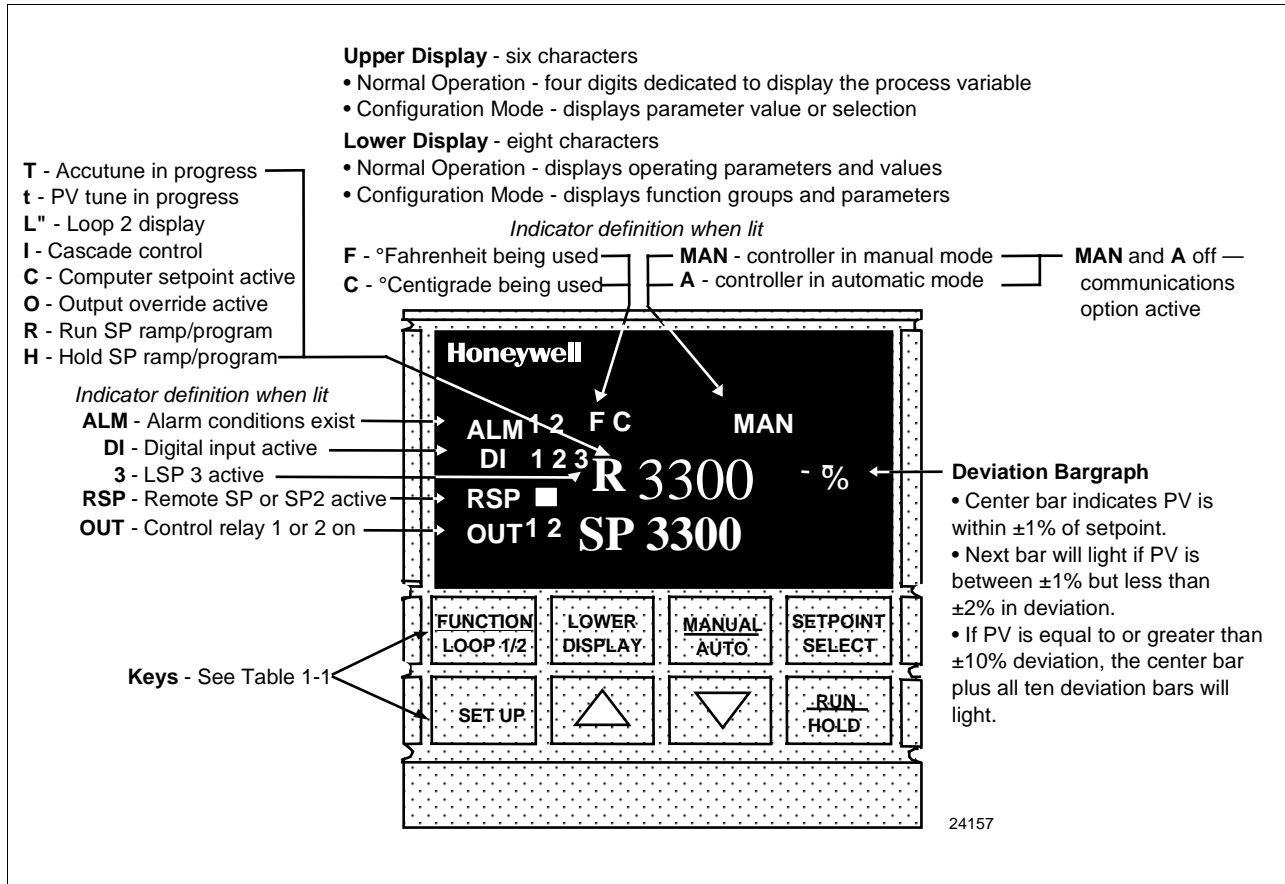
Deviation from the installation conditions specified in this manual, and the special conditions for CE conformity in Section 2.1, may invalidate this product's conformity with the Low Voltage and EMC Directives.

ATTENTION: The emission limits of EN 50081-2 are designed to provide reasonable protection against harmful interference when this equipment is operated in an industrial environment. Operation of this equipment in a residential area may cause harmful interference. This equipment generates, uses, and can radiate radio frequency energy and may cause interference to radio and television reception when the equipment is used closer than 30 meters (98 feet) to the antenna(e). In special cases, when highly susceptible apparatus is used in close proximity, the user may have to employ additional mitigating measures to further reduce the electromagnetic emissions of this equipment.

1.2 Operator Interface

Displays and indicators Figure 1-1 shows the operator interface and defines the displays and indicators. The function of the keys is shown in Table 1-1.

Figure 1-1 Operator Interface Displays and Indicators



Function of keys

Table 1-1 shows each key on the operator interface and defines its function.

Table 1-1 Function of Keys

Key	Function
SET UP	<ul style="list-style-type: none"> Places the controller in the Configuration Set Up group select mode. Sequentially displays Set Up groups and allows the FUNCTION key to display individual functions in each Set Up group.
FUNCTION LOOP 1/2	<ul style="list-style-type: none"> Used in conjunction with the SET UP key to select the individual functions of a selected Configuration Set Up group. Used to switch the display between Loop 1 and Loop 2 when the controller has a 2-Loop or Cascade configuration. Used during field calibration procedure.
LOWER DISPLAY	<ul style="list-style-type: none"> Selects an operating parameter to be shown in the lower display: <ul style="list-style-type: none"> OUT = Output (Note 1) OT2 = Output 2 (Cascade or 2-Loop applications) SP = Local Setpoint (also current SP value when using SP ramp) (Note 2) 2SP = Local Setpoint 2 (Note 2) 3SP = Local Setpoint 3 (Note 2) RSP = Remote Setpoint 1IN = Input 1—when used with combinational input algorithms 2IN = Input 2 3IN = Input 3 POS = 3 Position Step motor position when slidewire is connected CSP = Computer Setpoint Override DEV = Deviation PIDSETX = Tuning Parameter Set X=1 or 2 (Note 3) 2PIDSETX = Loop 2 Tuning Parameter Set X=1 or 2 ET_XX.XX = Elapsed Time TR_XX.XX = Time Remaining RAMPXXOM = Minutes Remaining in Setpoint Ramp <p>*Or estimated Three Position Step motor position when no slidewire exists.</p>

Key	Function
LOWER DISPLAY	<p> 1PV = For Cascade or 2 Loops 2PV = For Cascade or 2 Loops AUX = Auxiliary Output OC1 = Characterized Output 1 OC2 = Characterized Output 2 SPn = Setpoint Now (for setpoint rate) • (Sigma) = Current Totalizer Value BIA = Output Bias/Manual Reset Value TUNE OFF = Appears when Limit Cycle tuning is disabled TUNE RUN = Press ▲ and LOWER DISPLAY to initiate Limit Cycle tuning. Display will read TUNE RUN. ToBEGIN = Reset SP Program to start of first segment OTI = Internal Loop 1 Output Value is being displayed (Override has been selected and Loop 1 is in Automatic mode.) </p> <p>Note 1: Value can be changed if in manual mode Note 2: Value can be changed via increment/decrement keys. Note 3: The selected set can be changed via increment/decrement keys.</p>
<u>MANUAL</u> AUTO	<ul style="list-style-type: none"> Alternately selects: AUTO Lower display automatically displays setpoint value in engineering units. MAN Lower display automatically indicates output in %.
SETPOINT SELECT	<ul style="list-style-type: none"> Hold key down to cycle through configured setpoints.
<u>RUN</u> HOLD	<ul style="list-style-type: none"> Alternate action switch initiates or holds the Setpoint Ramp or Setpoint Program. Acknowledges a latched alarm 1.
▲	<ul style="list-style-type: none"> Increases the selected parameter value.
▼	<ul style="list-style-type: none"> Decreases the selected parameter value.

Section 2 – Installation

2.1 Overview

Introduction

Installation of the UDC 3300 Controller consists of mounting and wiring the controller according to the instructions given in this section.

Read the pre-installation information, check the model number interpretation and become familiar with your model selections, then proceed with installation.

What's in this section? This section contains the following information:

Topic		See Page
2.1	Overview	7
	Specifications	8
2.2	Model Number Interpretation	12
2.3	Mounting	13
2.4	Wiring	15
2.5	Wiring Diagrams	18
	Composite Wiring Diagram	18
	Line Voltage	19
	Input #1/Input #2	20
	Two HLAI	21
	Time Proportional Output	22
	Electromechanical	22
	Solid State	23
	10-amp Solid State	24
	Open Collector	25
	Current Output/Universal Output	26
	Two Current or Two Relay	26
	One Current (Auxiliary) and Three Relay	27
	Position Proportional Output	28
	Auxiliary Output	29
	Digital Inputs	29
	Communications	30
	RS422/485/Modbus	30
	DMCS	31
	Transmitter Power for 4-20 mA 2-wire Transmitter	32
	Using Open Collector Alarm 2 Output	32
	Using Auxiliary Output	33
2.6	Control and Alarm Relay Contact Information	34

Pre-installation information

If the controller has not been removed from its shipping carton, inspect the carton for damage and remove the controller. Inspect the unit for any obvious shipping damage and report any damage due to transit to the carrier.

Make sure that the carton with the controller includes

- a bag containing mounting hardware and
- a bag containing input resistors.

Check that the model number shown on the inside of the case agrees with what you have ordered.

CE conformity special conditions (Europe)

Shielded twisted pair cables are required for all Analog I/O, Process Variable, RTD, Thermocouple, dc millivolt, low level signal, 4-20 mA, Digital I/O, and computer interface circuits. Refer to the Severe Electrical Noise Environments document (51-52-05-01) for additional information.

Specifications

We recommend that you review the specifications and adhere to the operating limits listed in Table 2-1 when you install your controller.

Table 2-1 Specifications

Design	
Input Accuracy	± 0.20 % of span typical (± 1 digit for display) Field calibratable to ± 0.05 % of span typical 15 bit resolution typical
Sampling Rate	Inputs sampled six times a second
Temperature Stability	± 0.01 % of Full Scale/°C change typical
Input Signal Failure Protection	<i>Thermocouple Inputs:</i> Upscale or downscale burnout <i>Burnout Current:</i> 0.13 microamps <i>Failsafe Output Level:</i> Configurable 0-100 %
Input Impedance	<i>4-20 Milliampere Input:</i> 250 ohms <i>0-10 Volt Input:</i> 200K ohms <i>All Other:</i> 10 megohms
Maximum Lead Wire Resistance	<i>Thermocouples:</i> 100 ohms/leg <i>100, 200, and 500 RTD:</i> 100 ohms/leg <i>100 ohm Low RTD:</i> 10 ohms/leg
Stray Rejection	Common Mode <i>AC (50 or 60 Hz):</i> 120 dB (with maximum source impedance of 100 ohms) or ± 1 LSB (least significant bit) whichever is greater with line voltage applied. <i>DC:</i> 120 dB (with maximum source impedance of 100 ohms) or a ±1 LSB whichever is greater with 120 Vdc applied. <i>DC (to 1 KHz):</i> 80 dB (with maximum source of impedance of 100 ohms) or ±1 LSB whichever is greater with 50 Vac applied. Normal Mode <i>AC (50 or 60 Hz):</i> 60 dB (with 100 % span peak-to-peak maximum)

Design (continued)	
Isolation (Functional)	<p><i>AC Power:</i> Is electrically isolated from all other inputs and outputs to withstand a HIPOT potential of 1900 Vdc for 2 seconds per Annex K of EN61010-1.</p> <p><i>Analog Inputs and Outputs:</i> Are isolated from each other and all other circuits at 850 Vdc for 2 seconds.</p> <p><i>Digital Input and Digital Output:</i> Are isolated from all other circuits at 850 Vdc for 2 seconds.</p> <p><i>Relay Contacts:</i> With a working of 115/230 Vac, isolated from each other and all other circuits at 345 Vdc for 2 seconds.</p>
Alarm Outputs	<p>One SPDT electromechanical relay.</p> <p>A second alarm is available using the second control relay. This is not available with Relay Duplex, Position Proportional, or Three Position Step control.</p> <p><i>Alarm Relay Contacts Rating</i> <i>Resistive Load:</i> 5 ampere at 120 Vac or 30 Vdc, 2.5 A at 240 Vac.</p>
Controller Output Types	<p>Current Output (Isolated) Range can be set anywhere between 0 to 21 mA, and as direct or reverse action. <i>Resolution:</i> 11 bits for 0 to 21 mA <i>Accuracy:</i> 0.5 % full scale <i>Temperature Stability:</i> 0.1 % F.S./°C <i>Load Resistance:</i> 0 to 1000 ohms</p> <p>Electromechanical Relays (One or Two) SPDT contacts. Both Normally Open and Normally Closed contacts are brought out to the rear terminals. Internally socketed <i>Resistive Load:</i> 5 amps @ 120 Vac or 30 Vdc, 2.5A at 240 Vac <i>Inductive Load:</i> 50 VA @ 120 Vac or 240 Vac <i>Motor:</i> 1/6 H.P.</p> <p>Solid State Relays (One or Two) SPST solid state contacts consisting of a triac N.O. output. Internally socketed <i>Resistive Load:</i> 1.0 amp @ 25 °C and 120 or 240 Vac 0.5 amp @ 55 °C and 120 or 240 Vac <i>Inductive Load:</i> 50 VA @ 120 Vac or 240 Vac <i>Minimum Load:</i> 20 milliamps</p> <p>Open Collector Outputs (One or Two) <i>Maximum Sink Current:</i> 20 mA <i>Overload Protection:</i> 100 mA Internally powered @ 30 Vdc Opto-isolated from all other circuits except current output, but not from each other. Socketed jumper assembly replaces relay.</p> <p>Solid State Relays (10 amps) One or two externally mounted SPST triac N.O. outputs for use with open collector outputs. <i>Resistive Load:</i> 15 amps @ 25 °C and 120 or 240 Vac 10 amps @ 55 °C and 120 or 240 Vac <i>Inductive Load:</i> 50 VA @ 120 Vac or 240 Vac <i>Motor Rating:</i> 1 HP @ 25 °C 0.75 HP @ 55 °C</p>
Controller Output Algorithms	See Section 4.7.

Design (continued)	
Digital Inputs (Optional) (Isolated)	+15 Vdc source for external dry contacts or isolated solid state contacts. The Digital Input option detects the state of external contacts for either of the two inputs. On contact closure the controller will respond according to how each digital input is configured. Opening contact causes return to previous state.
Auxiliary Linear Output (Optional) (Isolated)	21 mA dc maximum into a negative or positive grounded load or non-grounded load of 0 to 1000 ohms. Output range can be set anywhere between 0 mA to 21 mA, and as direct or reverse action. It can be configured to represent either Input, PV, Setpoint, Deviation, or Control output. The range of the auxiliary output, as a function of the selected variable, can be scaled. This output can be used as a second current output for current duplex outputs. <i>Resolution:</i> 12 bits over 0 mA to 21 mA <i>Accuracy:</i> 0.05 % of full scale <i>Temperature Stability:</i> 0.0075 % F.S./°C <i>Load Resistance:</i> 0 to 1000
Communications Interface (Optional)	
DMCS	<i>Baud Rate:</i> 19200 baud <i>Length of Link:</i> 4000 ft. maximum <i>Link Characteristics:</i> Two-wire, multi-drop proprietary protocol, 31 drops maximum
RS422/485 ASCII	<i>Baud Rate:</i> 2400, 4800, 9600, or 19200 baud selectable <i>Parity:</i> Odd or Even <i>Length of Link:</i> 4000 ft. maximum <i>Link Characteristics:</i> Two-wire or four-wire, multi-drop RS422 ASCII, 15 drops maximum or up to 31 drops for shorter link length.
RS422/485 Modbus RTU	<i>Baud Rate:</i> 2400, 4800, 9600, 19200 baud selectable <i>Data Format:</i> Floating point or integer <i>Length of Link:</i> 4000 ft. maximum <i>Link Characteristics:</i> Two-wire, multi-drop Modbus RTU protocol, 15 drops maximum or up to 31 drops for shorter link length.
Power Consumption	18 VA maximum (90 Vac to 264 Vac); 12 VA maximum (24 Vac/dc)
Power Inrush Current	10A maximum for 4 ms (under operating conditions) CAUTION When applying power to more than one UDC 3300, make sure that sufficient power is supplied. Otherwise, the controllers may not start up normally due to voltage drop from the inrush current.
Weight	1.3 kg (3 lb.)

Environmental and Operating Conditions				
Parameter	Reference	Rated	Operative Limits	Transportation and Storage
Ambient Temperature	25 ± 3 °C 77 ± 5 °F	15 to 55 °C 58 to 131 °F	0 to 55 °C 32 to 131 °F	-40 to 66 °C -40 to 151 °F
Relative Humidity	10 to 55*	10 to 90*	5 to 90*	5 to 95*
Vibration Frequency (Hz) Acceleration (g)	0 0	0 to 70 0.4	0 to 200 0.6	0 to 200 0.5
Mechanical Shock Acceleration (g) Duration (ms))	0 0	1 30	5 30	20 30
Voltage (Vdc)	+24 ± 1	20 to 27	20 to 27	--
Voltage (Vac) 90 to 240 Vac 24 Vac	120 ± 1 240 ± 2 24 ± 1	90 to 240 20 to 27	90 to 264 20 to 27	-- -- --
Frequency (Hz) (For Vac)	50 ± 0.2 60 ± 0.2	49 to 51 59 to 61	48 to 52 58 to 62	-- --

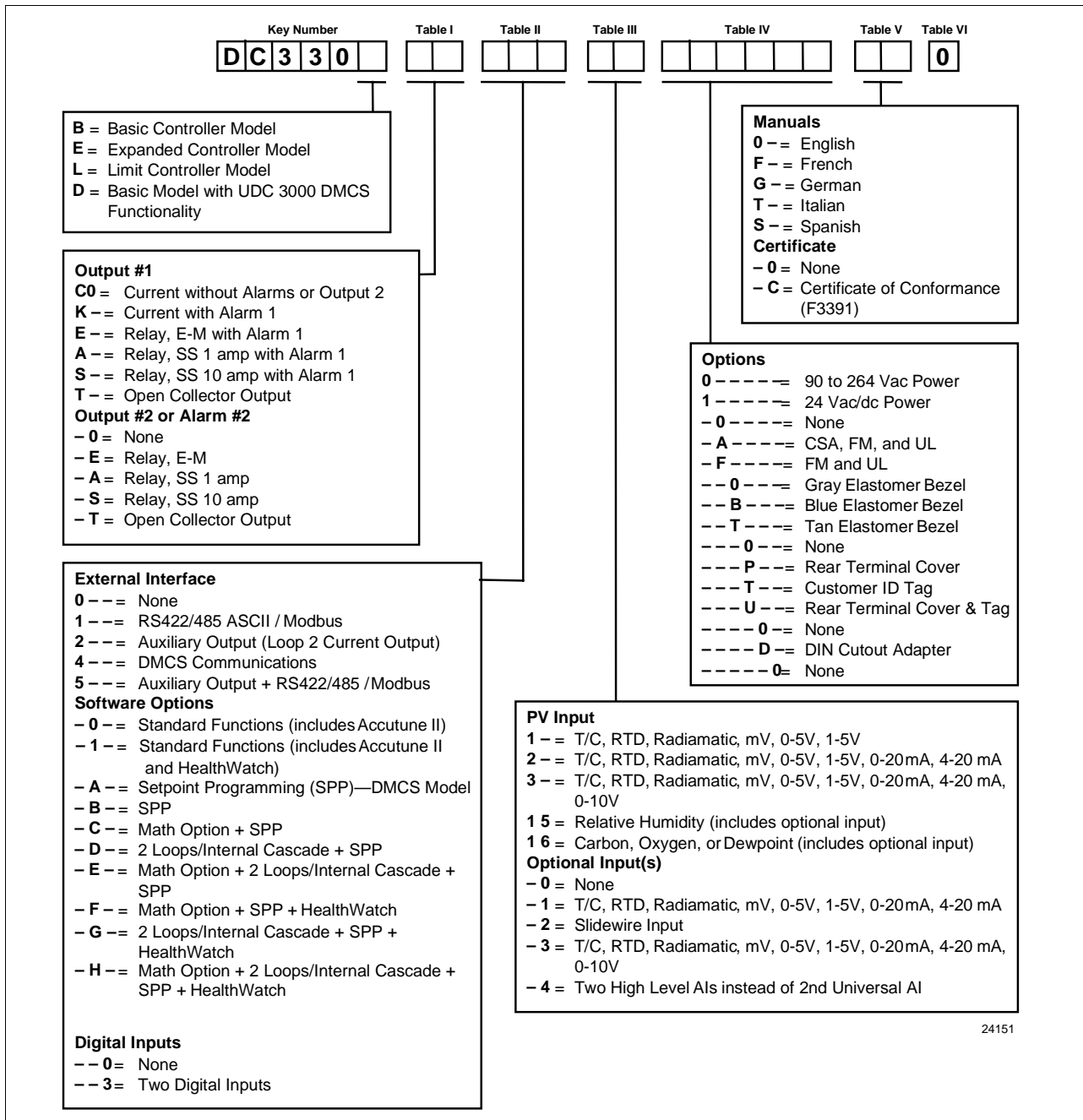
* The maximum rating only applies up to 40 °C (104 °F). For higher temperatures, the RH specification is derated to maintain constant moisture content.

2.2 Model Number Interpretation

Model number

The model number interpretation is shown in Figure 2-1. Write the model number into the spaces provided and compare it to the model number interpretation. This information will also be useful when you wire your controller.

Figure 2-1 Model Number Interpretation



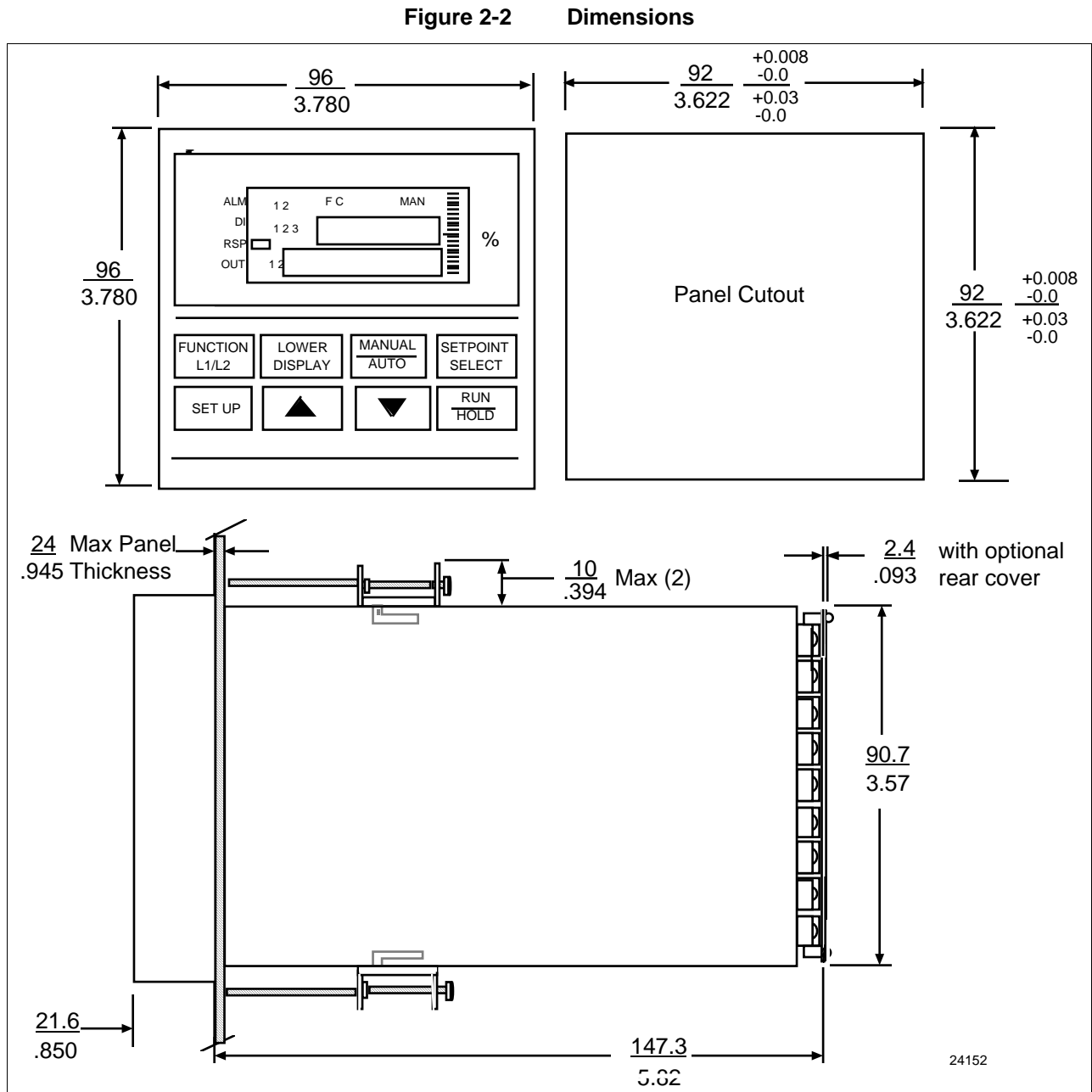
24151

2.3 Mounting

Physical considerations The controller can be mounted on either a vertical or tilted panel using the mounting kit supplied. Adequate access space must be available at the back of the panel for installation and servicing activities.

The overall dimensions and panel cutout requirements for mounting the controller are shown in Figure 2-2.

Overall dimensions Figure 2-2 shows the overall dimensions for mounting the controller.

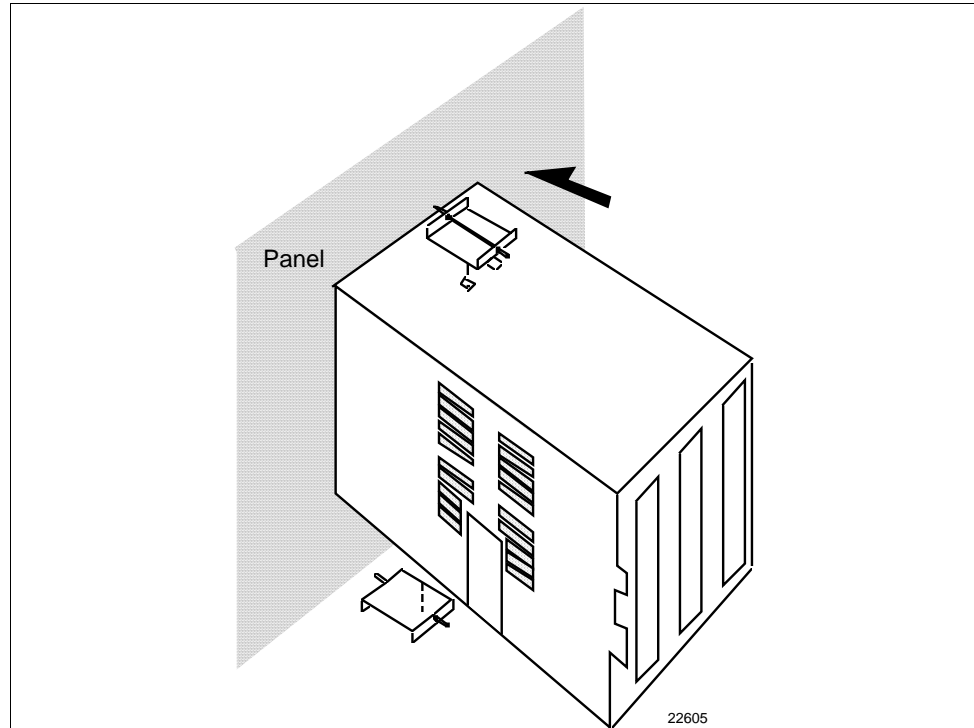


Mounting method

Before mounting the controller, refer to the nameplate on the inside of the case and make a note of the model number. It will help later when selecting the proper wiring configuration.

Figure 2-3 shows you the mounting method for the UDC 3300 controller.

Figure 2-3 Mounting Method



Mounting procedure

Refer to Figure 2-3 and follow the procedure in Table 2-2 to mount the controller.

Table 2-2 Procedure for Mounting the Controller

Step	Action
1	Mark and cut out the controller hole in the panel according to the dimension information in Figure 2-2.
2	Remove the screw cover and loosen the screw on the front of the controller. Pull the chassis out of the case.
3	Orient the case properly and slide it through the panel hole from the front.
4	Remove the mounting kit from the shipping container, and install the kit as follows: <ul style="list-style-type: none">• Install the screws into the threaded holes of the clips.• Insert the prongs of the clips into the two holes in the top and bottom of the case.• Tighten both screws to secure the case against the panel.• Carefully slide the chassis assembly into the case, press to close and tighten the screw. Replace the screw cover.

2.4 Wiring

Electrical considerations



The controller is considered “rack and panel mounted equipment” per EN 61010-1, Safety Requirements for Electrical Equipment for Measurement, Control, and Laboratory Use, Part 1: General Requirements. Conformity with 72/23/EEC, the Low Voltage Directive requires the user to provide adequate protection against a shock hazard. The user shall install this controller in an enclosure that limits OPERATOR access to the rear terminals.

Controller grounding

PROTECTIVE BONDING (grounding) of this controller and the enclosure in which it is installed shall be in accordance with National and local electrical codes. To minimize electrical noise and transients that may adversely affect the system, supplementary bonding of the controller enclosure to a local ground, using a No. 12 (4 mm²) copper conductor, is recommended.

Control/alarm circuit wiring

The insulation of wires connected to the Control/Alarm terminals shall be rated for the highest voltage involved. Extra Low Voltage (ELV) wiring (input, current output, and low voltage Control/Alarm circuits) shall be separated from HAZARDOUS LIVE (>30 Vac, 42.4 V_{peak}, or 60 V_{dc}) wiring per Table 2-3.

Electrical Noise Precautions

Electrical noise is composed of unabated electrical signals which produce undesirable effects in measurements and control circuits.

Digital equipment is especially sensitive to the effects of electrical noise. Your controller has built-in circuits to reduce the effect of electrical noise from various sources. If there is a need to further reduce these effects:

- Separate External Wiring - separate connecting wires into bundles (see Table 2-3) and route the individual bundles through separate conduits or metal trays.
- Use Suppression Devices - for additional noise protection, you may want to add suppression devices at the external source. Appropriate suppression devices are commercially available.

ATTENTION For additional noise information, refer to document number 51-52-05-01, *How to Apply Digital Instrumentation in Severe Electrical Noise Environments*.

Permissible wire bundling

Table 2-3 shows which wire functions should be bundled together.

NOTE For installation where high EMI/RFI noise cannot be avoided, we recommend you use shielded twisted pair wires for the signals in bundle 2.

Table 2-3 Permissible Wiring Bundling

Bundle No.	Wire Functions
1	<ul style="list-style-type: none">• Line power wiring• Earth ground wiring• Control relay output wiring• Line voltage alarm wiring
2	Analog signal wire, such as: <ul style="list-style-type: none">• Input signal wire (thermocouple, 4 to 20 mA, etc.)• 4-20 mA output signal wiring• Slidewire feedback circuit wiring• Digital input signals• Communications
3	<ul style="list-style-type: none">• Low voltage alarm relay output wiring• Low voltage wiring to solid state type control circuits

Identify your wiring requirements

To determine the appropriate diagrams for wiring your controller, refer to the model number interpretation in this section. The model number of the controller can be found on the inside of the case.

Wiring the controller

Using the information contained in the model number, select the appropriate wiring diagrams from the figures listed below and wire the controller accordingly.

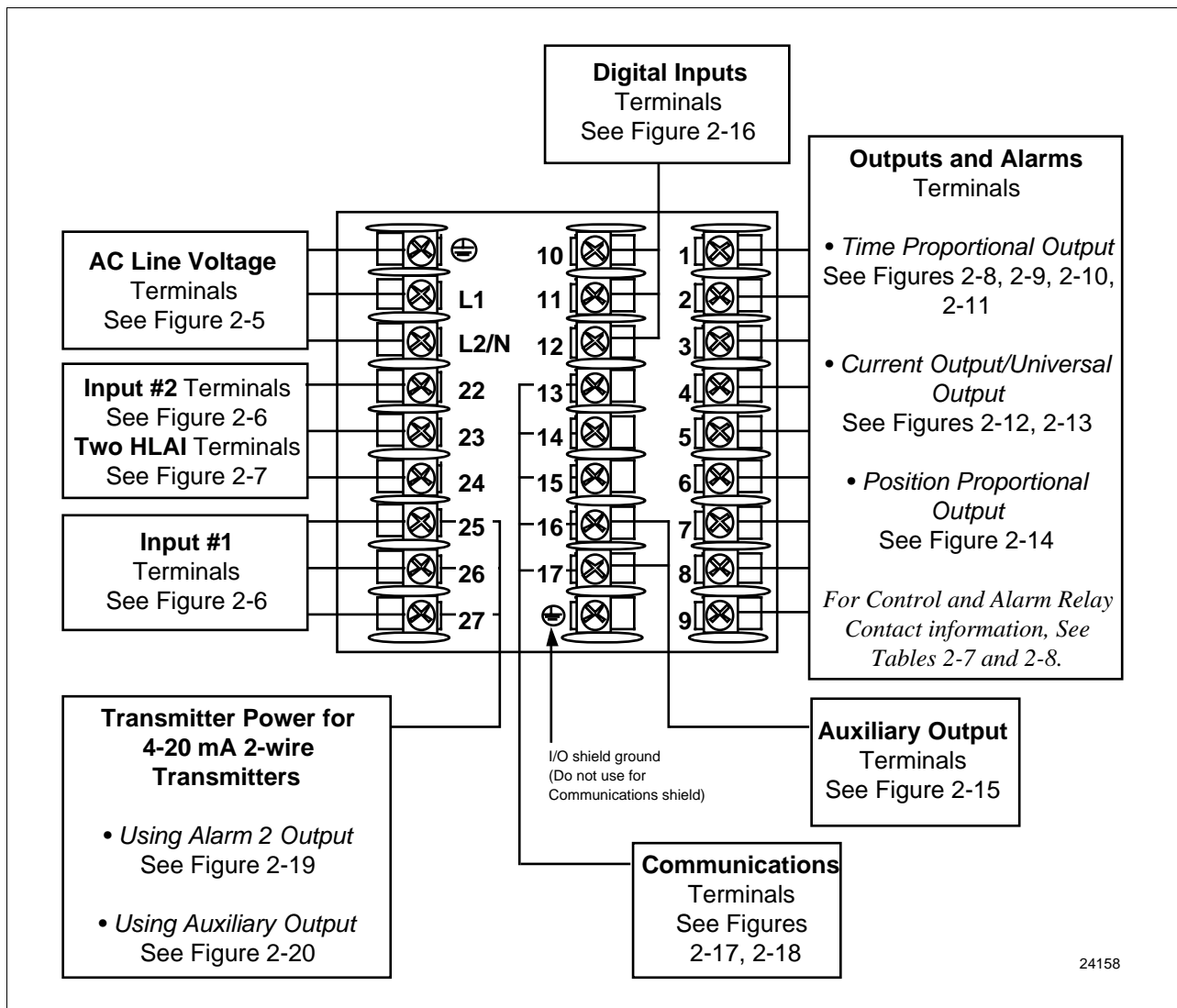
Wiring Requirements	Figure
Composite Wiring Diagram	2-4
Line Power 90–264 Vac or 24Vac/dc	2-5
Input #1 and Input #2 Wiring	2-6
Two HLAI Wiring	2-7
Time Proportional Output <ul style="list-style-type: none">• Electromechanical Relay Output• Solid State Relay Output• 10-amp Solid State Relay Output• Open Collector Output	2-8 2-9 2-10 2-11
Current Output/Universal Output <ul style="list-style-type: none">• Two Current and Two Relay Outputs• One Current (Auxiliary) and Three Relay Outputs	2-12 2-13
Position Proportional Output	2-14
Auxiliary Output Wiring	2-15
Digital Inputs Wiring	2-16
Communications Wiring <ul style="list-style-type: none">• RS422/485/Modbus• DMCS	2-17 2-18
Transmitter Power for 4-20 mA 2-wire Transmitters <ul style="list-style-type: none">• Open Collector Alarm 2 Output• Auxiliary Output	2-19 2-20

2.5 Wiring Diagrams

Composite wiring diagram

Figure 2-4 is a composite wiring diagram of the UDC 3300 controller. It identifies the terminal designations and their functions. Refer to the individual diagrams listed to wire the controller according to your requirements.

Figure 2-4 Composite Wiring Diagram



Line voltage wiring

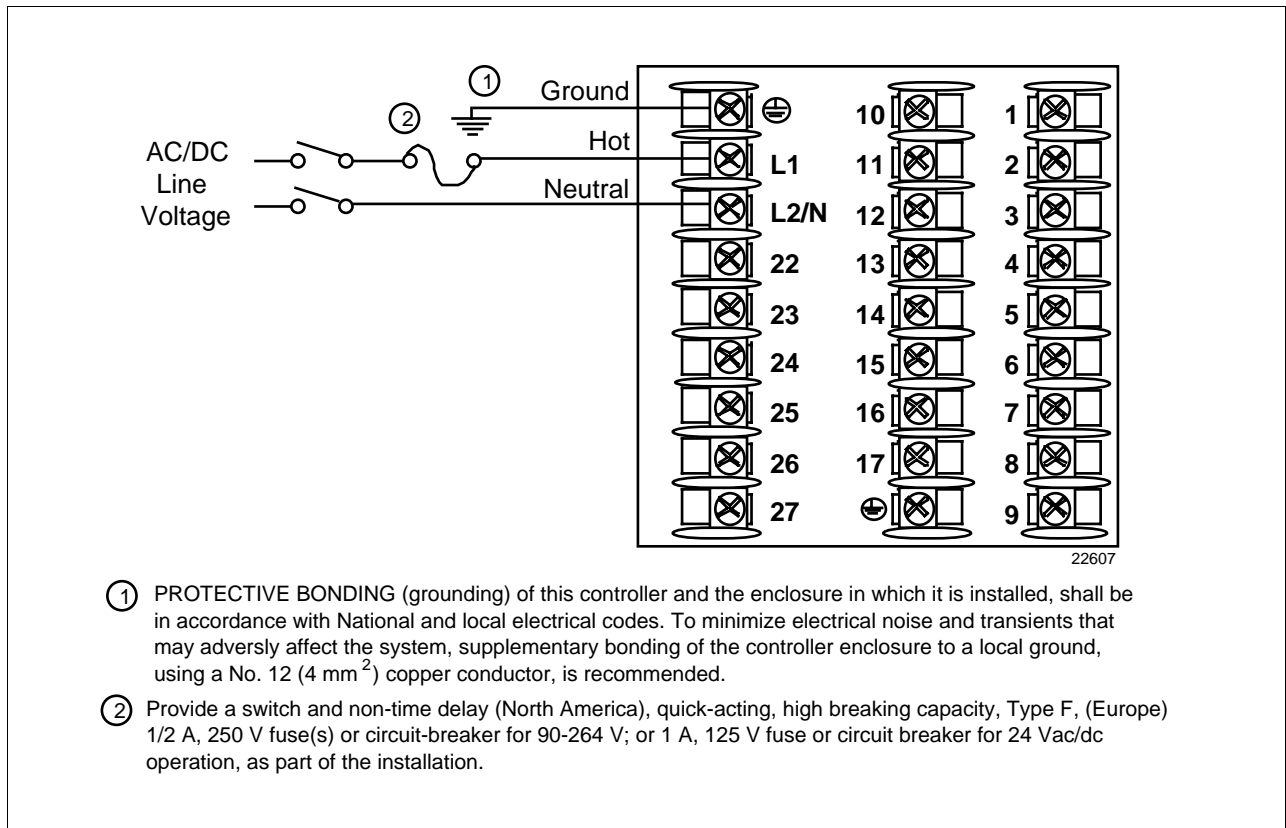
This equipment is suitable for connection to 90-264 Vac or 24 Vac/dc, 50/60 Hz, power supply mains. It is the user's responsibility to provide a switch and non-time delay (North America), quick-acting, high breaking capacity, Type F, (Europe) 1/2 A, 250 V fuse(s) or circuit-breaker for 90-264 V; or 1 A, 125 V fuse or circuit breaker for 24 Vac/dc operation, as part of the installation. The switch or circuit-breaker should be located close to the controller, *within easy reach of the operator*. The switch or circuit-breaker should be marked as the disconnecting device for the controller (4 mm²).

CAUTION Applying 90-264 Vac to a controller rated for 24 Vac/dc will severely damage the controller and is a fire and smoke hazard.

When applying power to multiple instruments, make sure that sufficient current is supplied. Otherwise, the instruments may not start up normally due to the voltage drop caused by the in-rush current.

Figure 2-5 shows the wiring connections for line voltage.

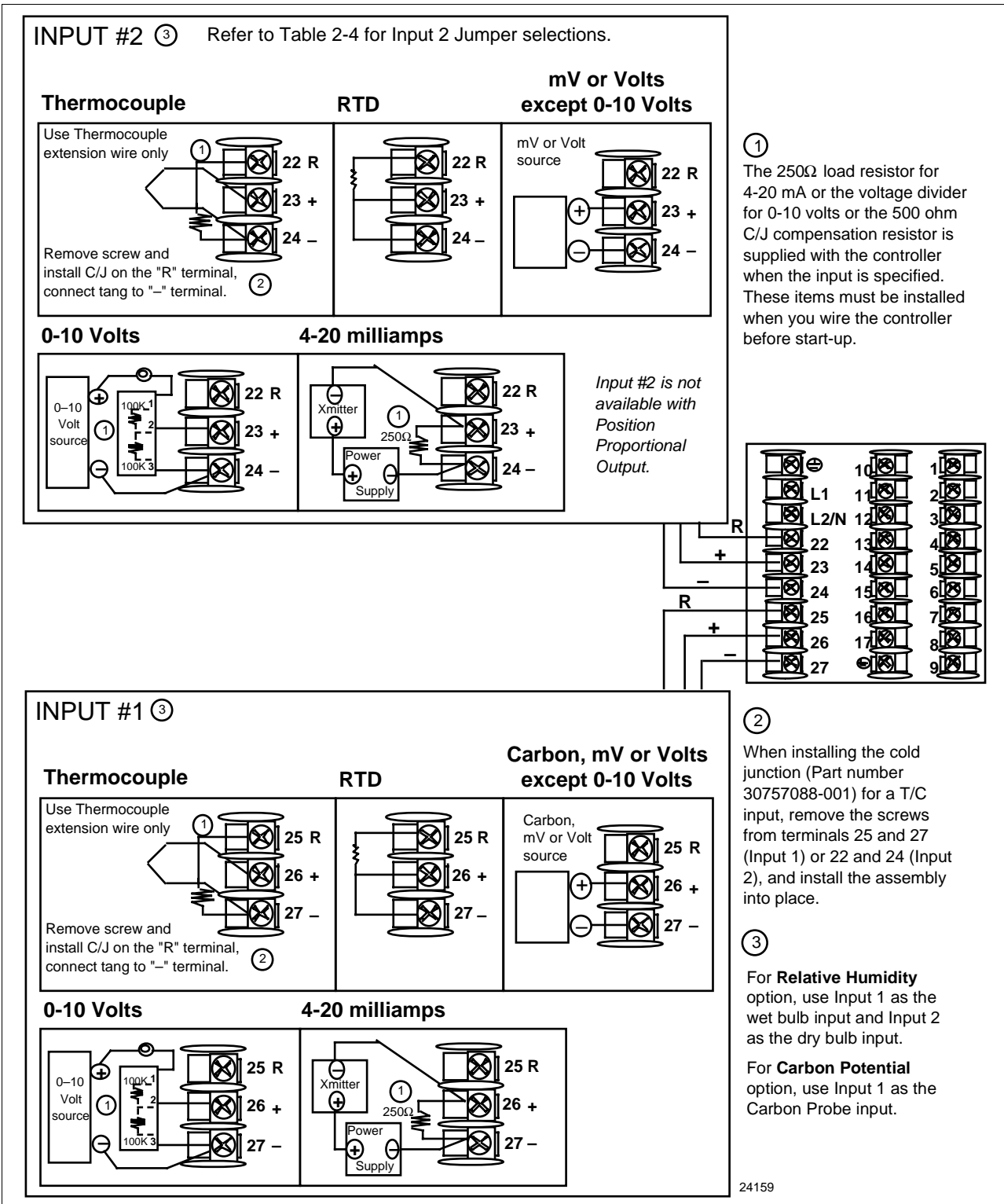
Figure 2-5 Line Voltage Wiring



Input #1/Input #2 connections

Figure 2-6 shows the wiring connections for Input #1 and Input #2.

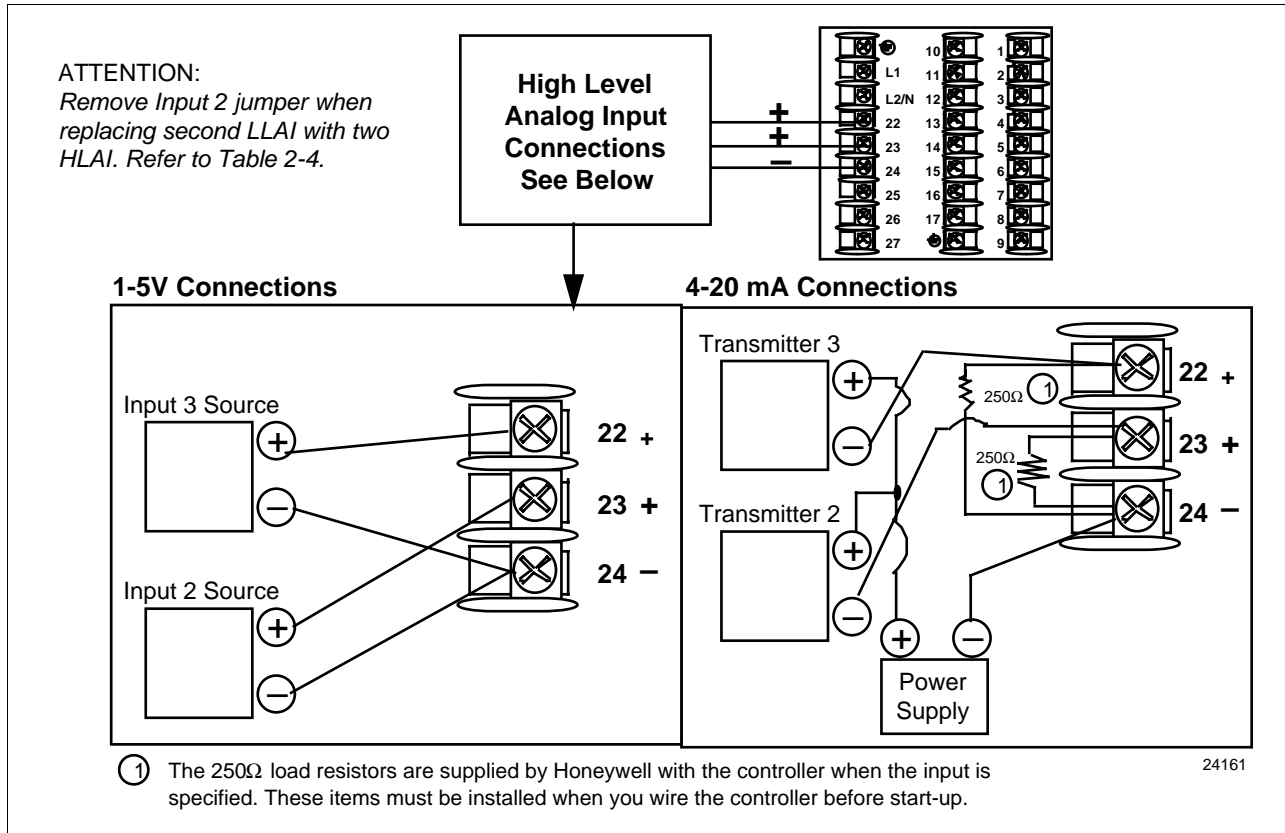
Figure 2-6 Input #1/Input #2 Connections



Two HLAI replace second LLAI connections

Figure 2-7 shows the wiring connections for replacing the second LLAI with two HLAI.

Figure 2-7 Two HLAI Replace 2nd LLAI Connections



Input 2 jumper

Table 2-4 shows the location of the second input jumper and the input types available for each jumper position.

Table 2-4 Input 2 Jumper Selections

Jumper Location			
Jumper Position	W1	W2	None (remove jumper)
Input Types Available	Slidewire	Thermocouple, RTD, mV, Radiamatic, Carbon, Oxygen, 4-20 mA, 0-20 mA, 1-5 V, 0-5 V	Two HLAI replace LLAI

Time proportional output

There are three types of Time Proportional outputs available on the UDC 3300.

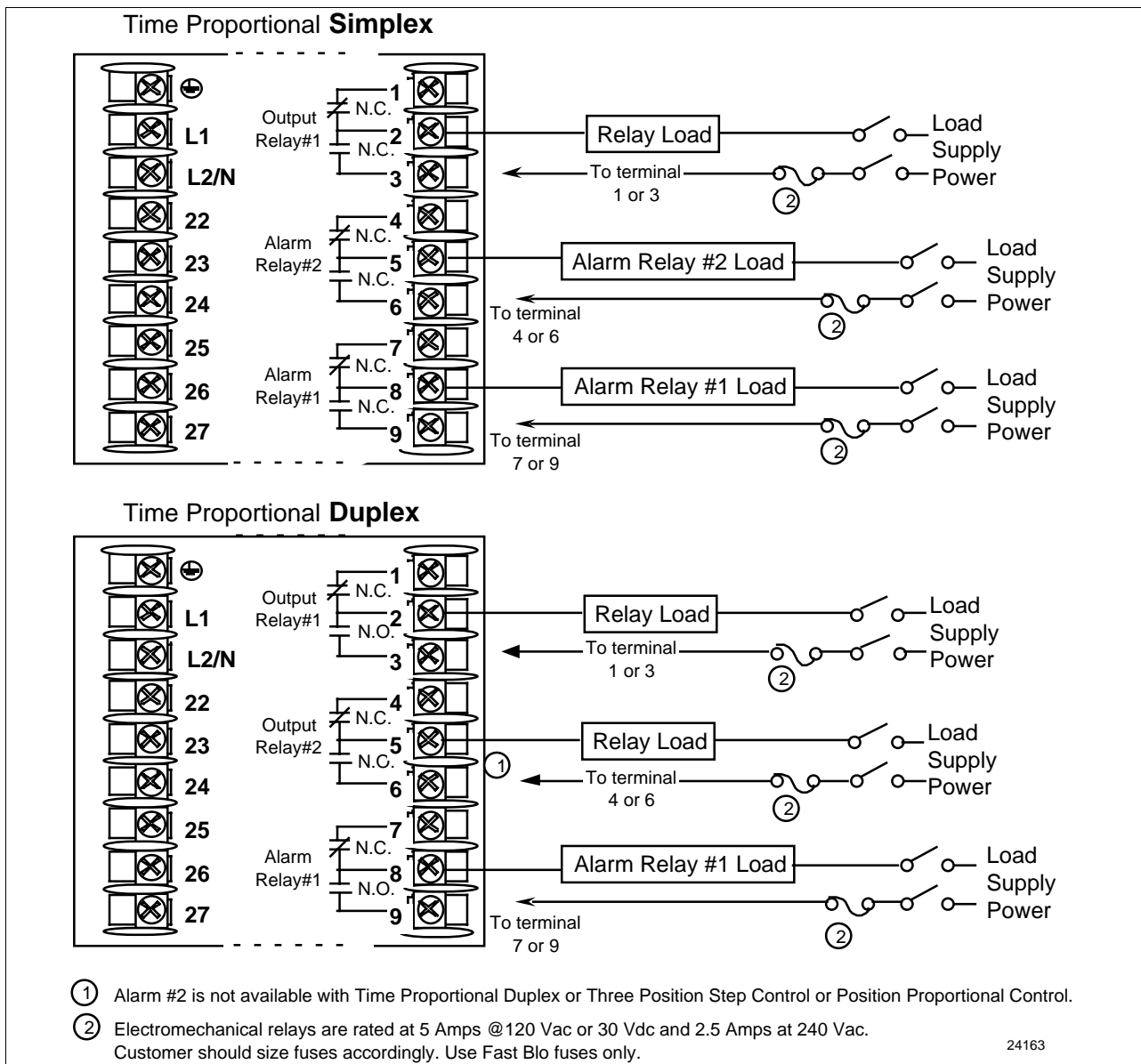
- Electromechanical Relay Output (**Model DC330X-EE-XXX**)—Figure 2-8
- Solid State Relay Output (**Model DC330X-AA(SS)-XXX**)—Figure 2-9
- Open Collector Output (**Model DC330X-TT-XXX**)—Figure 2-11

The Alarm wiring connections are the same for all three outputs.

For Control and Alarm Relay Contact information, see Tables 2-7 and 2-8.

Figure 2-8 shows the Output and Alarm wiring connections for models with Electromechanical Relay Output.

Figure 2-8 Electromechanical Relay Output—Model DC330X-EE-XXX

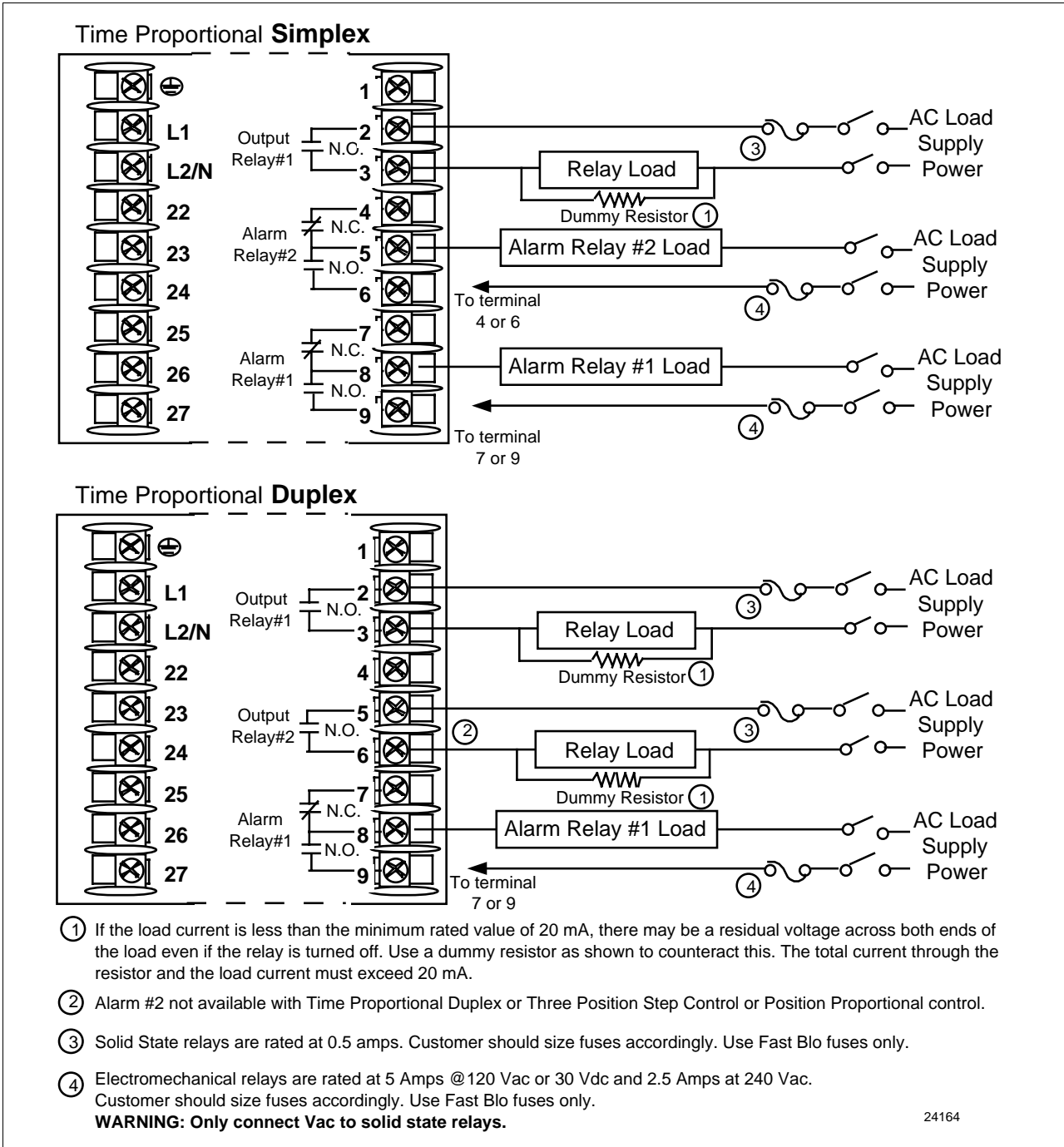


Time proportional output, continued

Figure 2-9 shows the Output and Alarm wiring connections for models with Solid State Relay Output (**Model DC330X-AA-XX**).

For Control and Alarm Relay Contact information, see Tables 2-7 and 2-8.

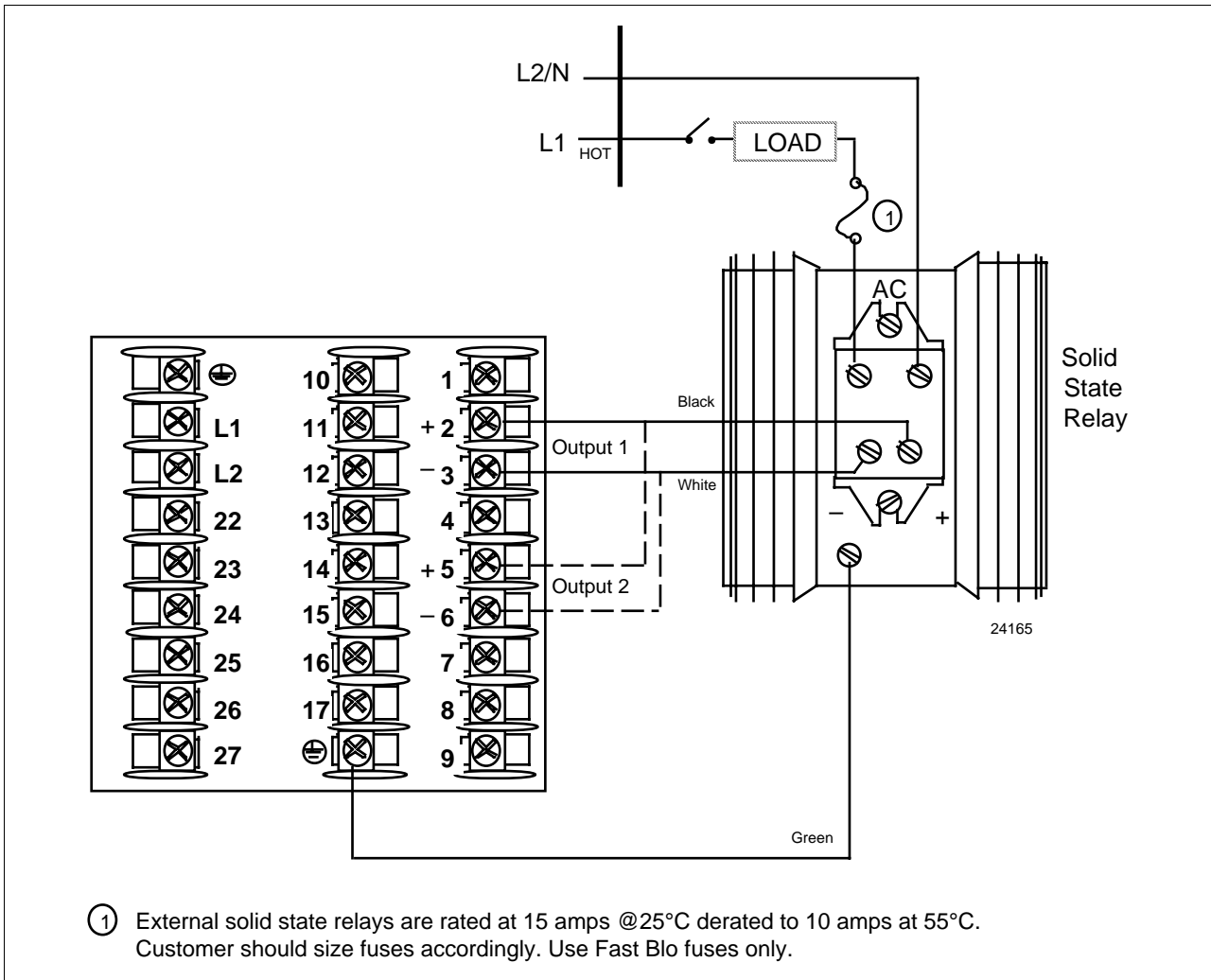
Figure 2-9 Solid State Relay Output—Model DC330X-AA-XX



Time proportional
output, continued

Figure 2-10 shows the wiring connections for the external 10-amp Solid State Relay Output (Model DC330X-SS-XX).

Figure 2-10 10-amp Solid State Relay Output—Model DC330X-SS-XX

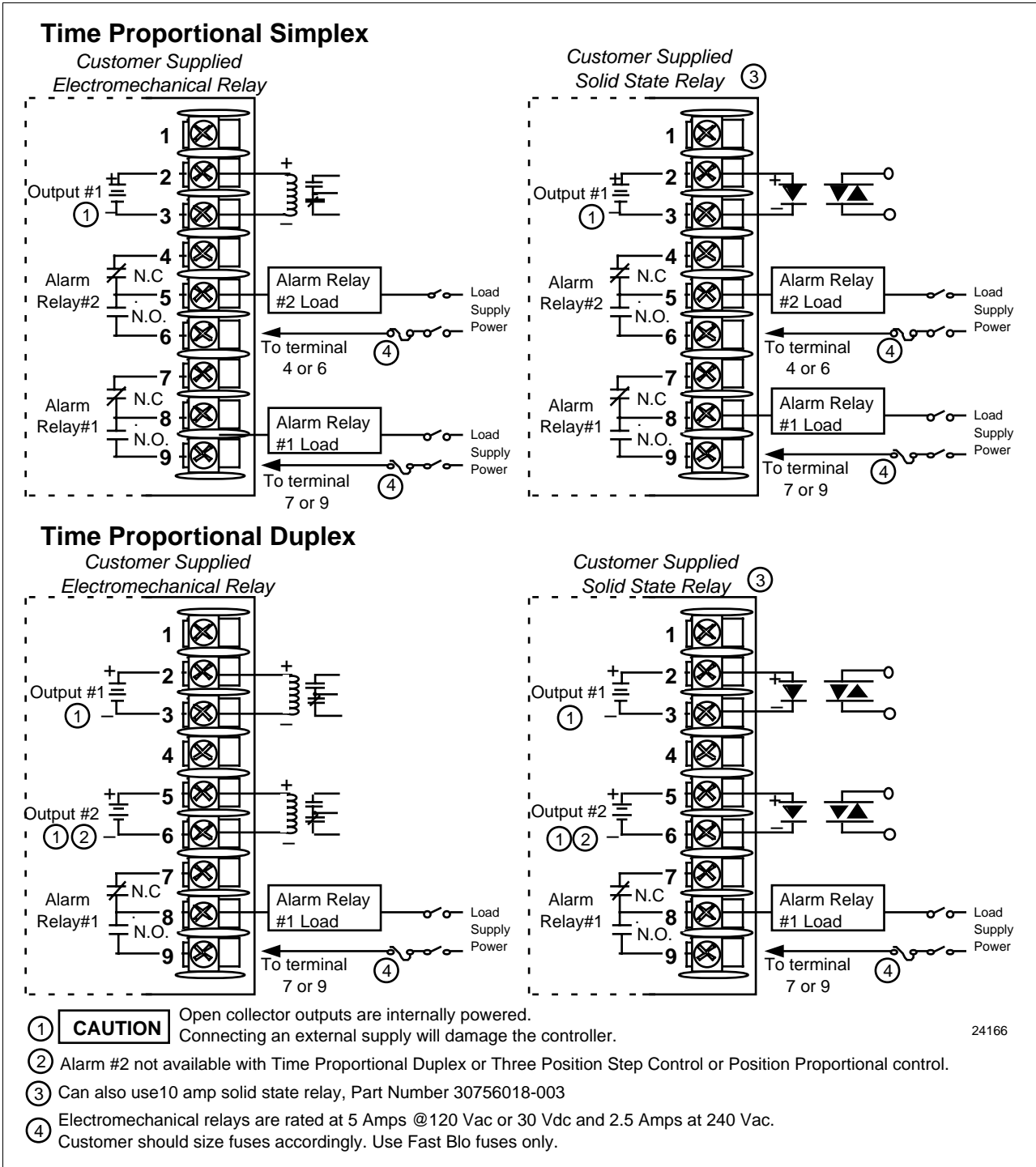


Time proportional output, continued

Figure 2-11 shows the Output and Alarm wiring connections for models with Open Collector Output (**DC330X-TT-XXX**)

For Control and Alarm Relay Contact information, see Tables 2-7 and 2-8.

Figure 2-11 Open Collector Output—Model DC330X-TT-XXX



**Current output/
universal output
connections**

Figure 2-12 shows the Output and Alarm wiring connections for models with Current Output (**Model DC330X-KE-XXX** and **Model DC330X-C0-XXX**). See Table 2-5 for wiring restrictions.

For Control and Alarm Relay Contact information, see Tables 2-7 and 2-8.

Figure 2-12 Current Output—Current /Time Duplex, Time/Current Duplex, Position Proportional, or Three Position Step Control

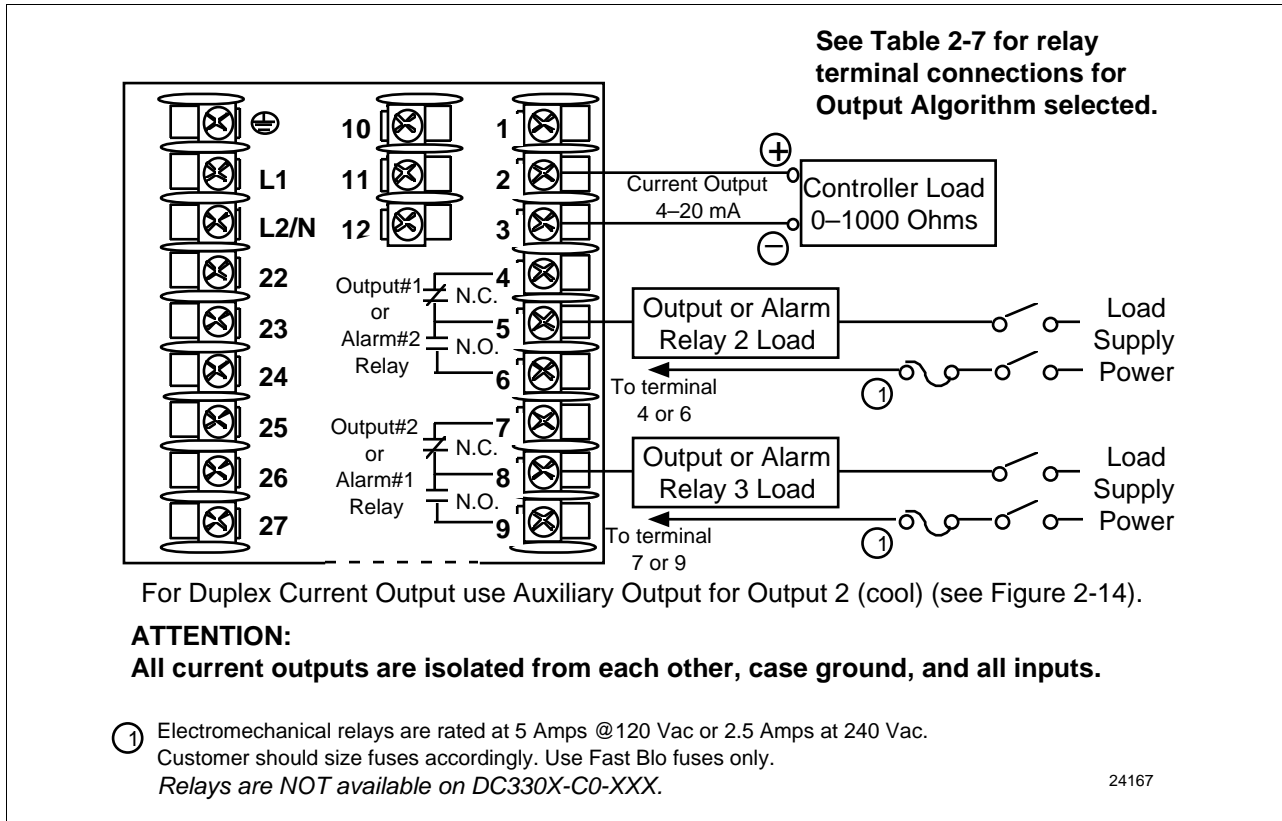


Table 2-5 Universal Output Wiring Functionality and Restrictions for Figure 2-12

Controller with Two Current Outputs and Two Relay Outputs SINGLE LOOP OR CASCADE CONTROL OUTPUT					
Output Type	Current	Auxiliary	Relay #1	Relay #2	Relay #3
Time Simplex	Not used	Not used	N/A	Output 1	Alarm 1
Current	Output 1	Not used	N/A	Alarm 2	Alarm 1
Position (not available on Cascade Control)	Not used	Not used	N/A	Output 1	Output 2
Time Duplex or TPSC	Not used	Not used	N/A	Output 1	Output 2
Current Duplex 100%	Output 1	Not used	N/A	Alarm 2	Alarm 1
Current Duplex 50%	Output 1	Output 2	N/A	Alarm 2	Alarm 1
Current/Time or Time/Current	Output 1 or 2	Not used	N/A	Output 1 or 2	Alarm 1

**Current output/
universal output
connections, continued**

Figure 2-13 shows the Output and Alarm wiring connections for models with a Current Output (Auxiliary Output) and three Relay Outputs (**Model DC330X-EE-2XX**). See Table 2-6 for wiring restrictions.

For Control and Alarm Relay Contact information, see Tables 2-7 and 2-8.

Figure 2-13 Auxiliary Output and Three Relay Outputs

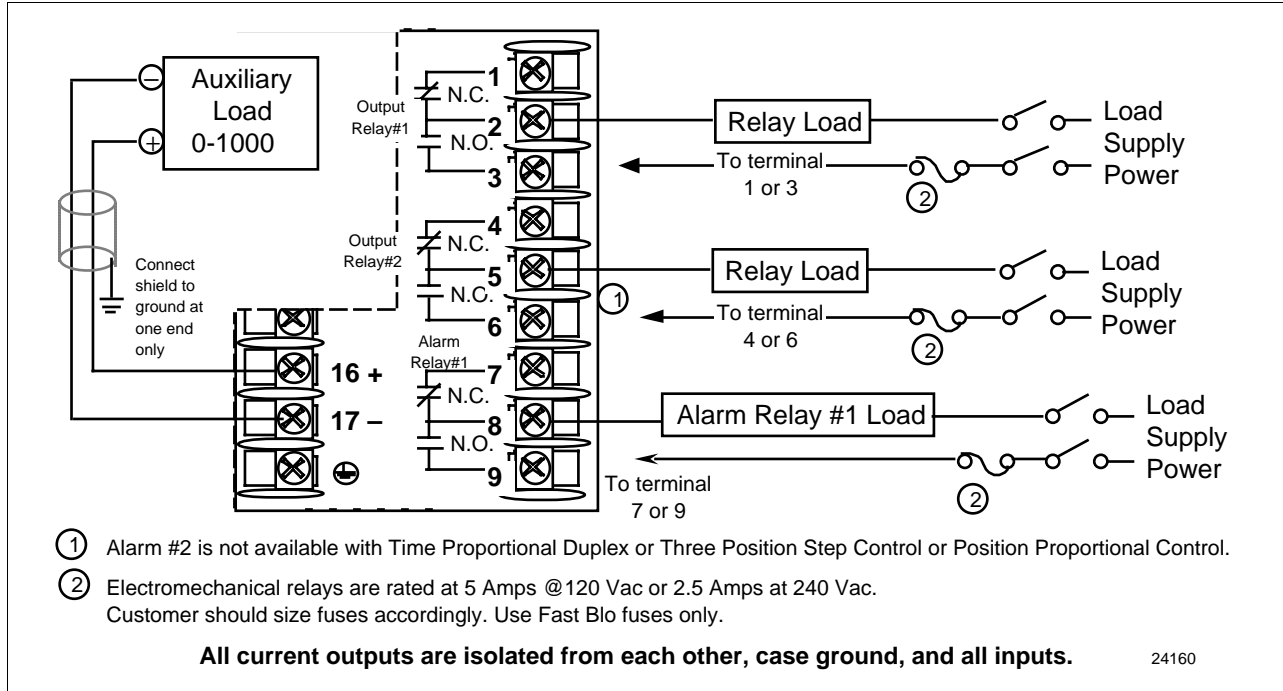


Table 2-6 Universal Output Wiring Functionality and Restrictions for Figure 2-13

Controller with One Current Output (Auxiliary Output) and Three Relay Outputs SINGLE LOOP OR CASCADE CONTROL OUTPUT					
Output Type	Current	Auxiliary	Relay #1	Relay #2	Relay #3
Time Simplex	N/A	Not used	Output 1	Alarm 2	Alarm 1
Current	N/A	Output 1	Not used	Alarm 2	Alarm 1
Position (not available on Cascade Control)	N/A	Not used	Output 1	Output 2	Alarm 1
Time Duplex or TPSC	N/A	Not used	Output 1	Output 2	Alarm 1
Current Duplex 100%	N/A	Output	N/A	Alarm 2	Alarm 1
Current Duplex 50% (N/A)	N/A	N/A	N/A	N/A	N/A
Current/Time or Time/Current	N/A	Output 1 or 2	Output 1 or 2	Alarm 2	Alarm 1

Position proportional output connections

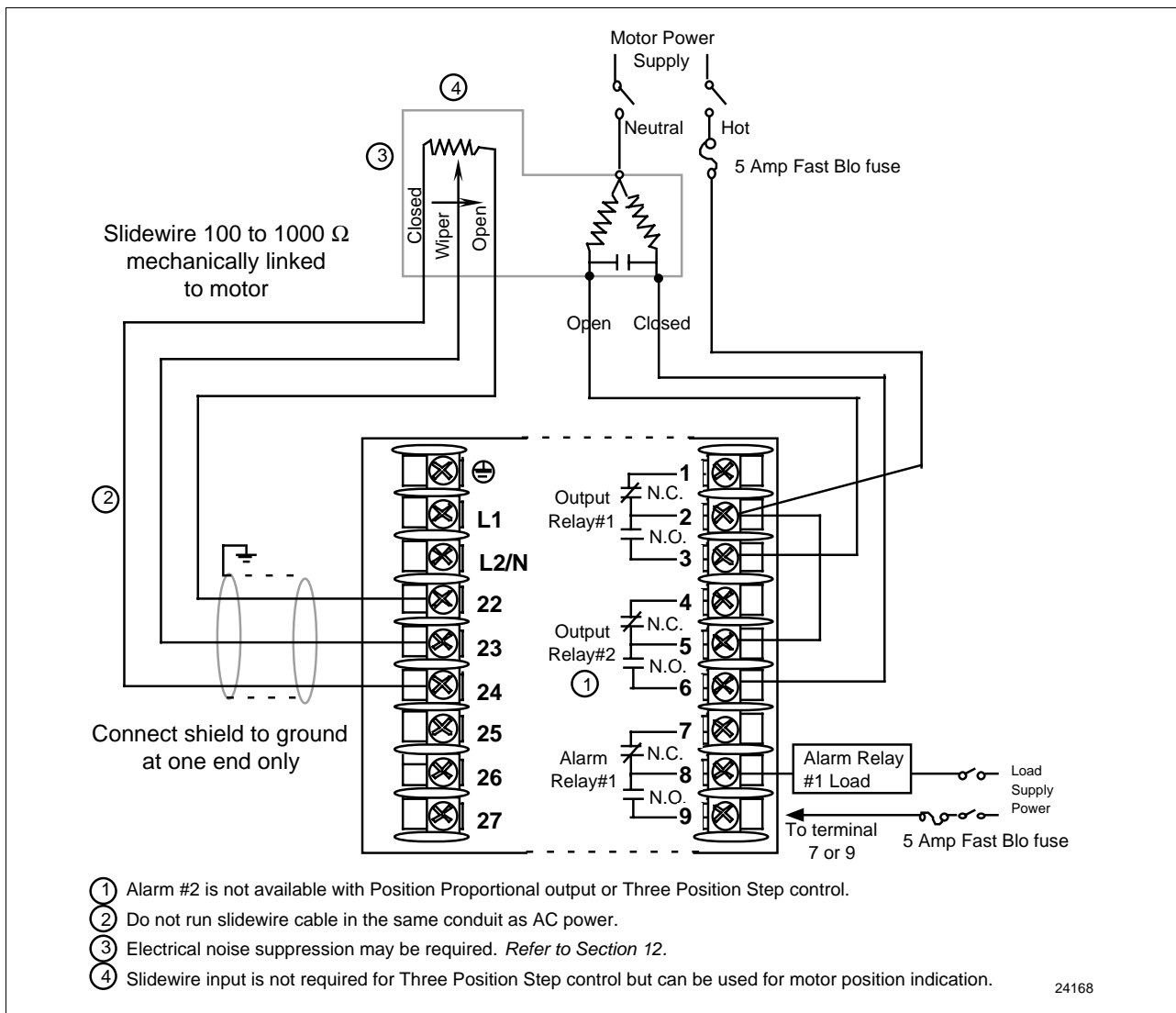
Figure 2-14 shows the Output and Alarm wiring connections for models with Position Proportional Output or Three Position Step Control (**Models DC330X-EE-XXX-X2, DC330X-AA-XXX-X2**).

For Control and Alarm Relay Contact information, see Tables 2-7 and 2-8.

Calibration

Position Proportional Output or *Three Position Step* models must have the output calibrated after installation (see *Section 8—Position Proportional Output Calibration*) to ensure that the displayed output (slidewire position) agrees with the actual final control element position. Three Position Step models only require that the motor time be entered. Full calibration is not required.

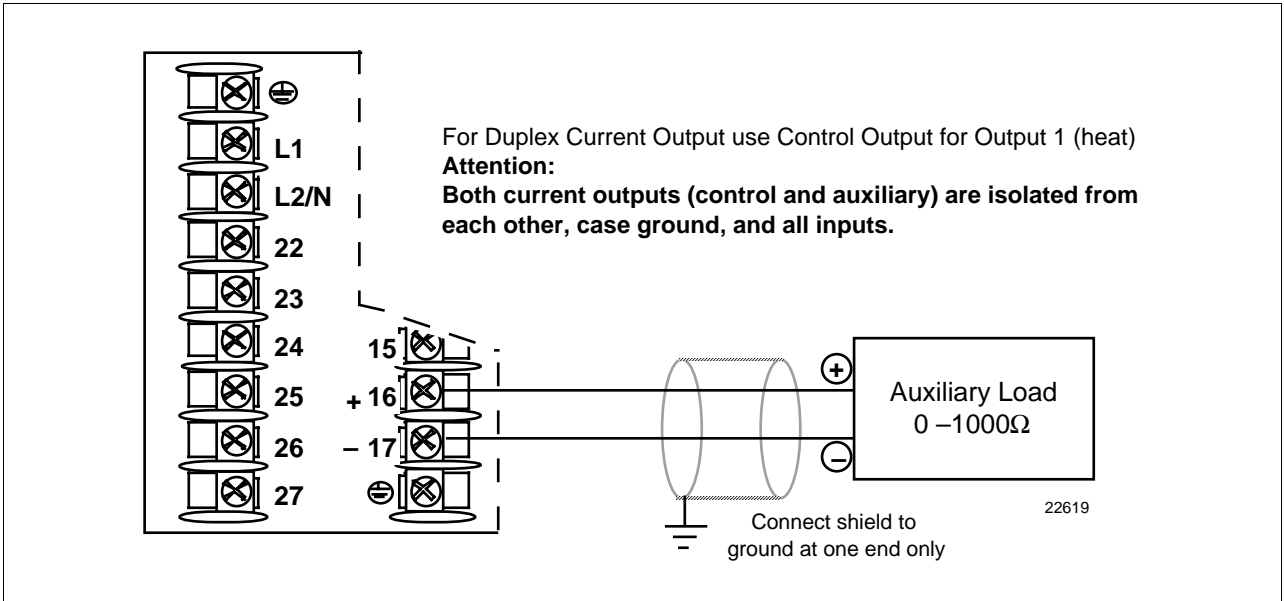
Figure 2-14 Position Proportional Output or Three Position Step—Models DC330X-EE-XXX-X2, DC330X-AA-XXX-X2



Auxiliary output connections

Figure 2-15 shows the wiring connections for the Auxiliary Output option (Models DC330X-XX-2XX, DC330X-XX-5XX).

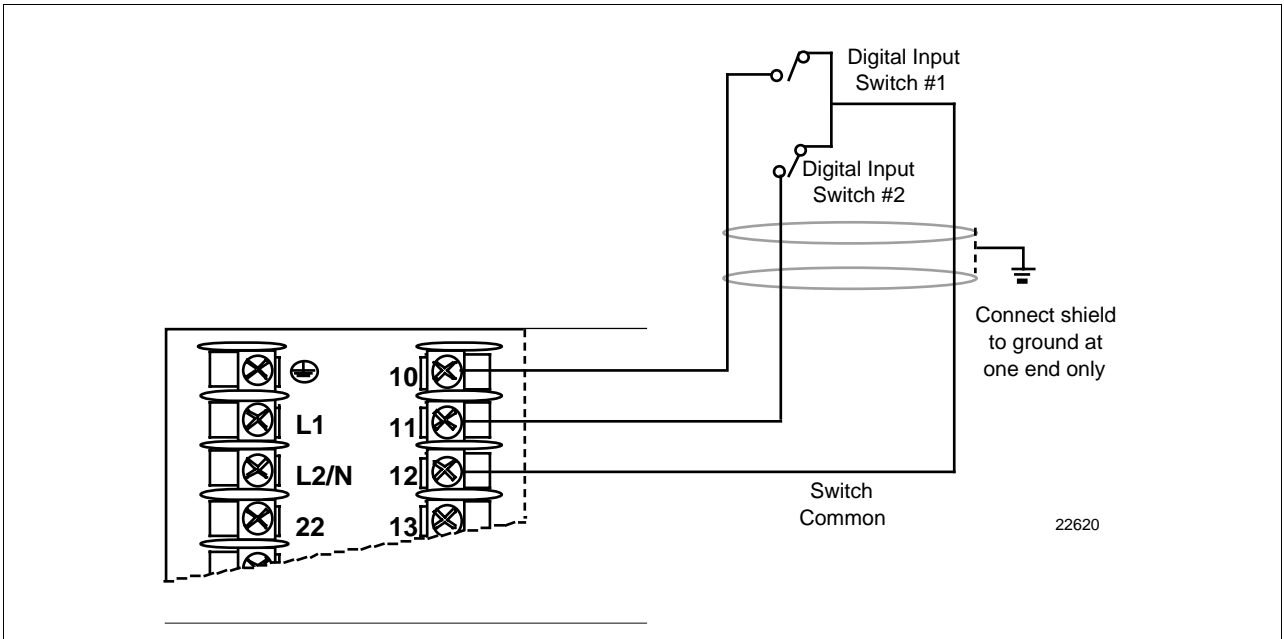
Figure 2-15 Auxiliary Output Connections—Models DC330X-XX-2XX, DC330X-XX-5XX



Digital inputs connections

Figure 2-16 shows the wiring connections for the Digital Inputs option (Model DC330X-XX-XX3).

Figure 2-16 Digital Inputs Connections—Model DC330X-XX-XX3



Communications option connections There are two types of Communications option available:

- RS422/485/Modbus (**Model DC330X-XX-1XX** or **DC330X-XX-5XX**)—Figure 2-17 [also refer to Document #51-51-25-35 (RS422/485 ASCII) or #51-52-25-66 and #51-52-25-70 (Modbus)]
- DMCS (**Model DC330X-XX-4XX**)—Figure 2-18 (also refer to Document #82-50-10-23)

Figure 2-17 RS422/485/Modbus Communications Option Connections

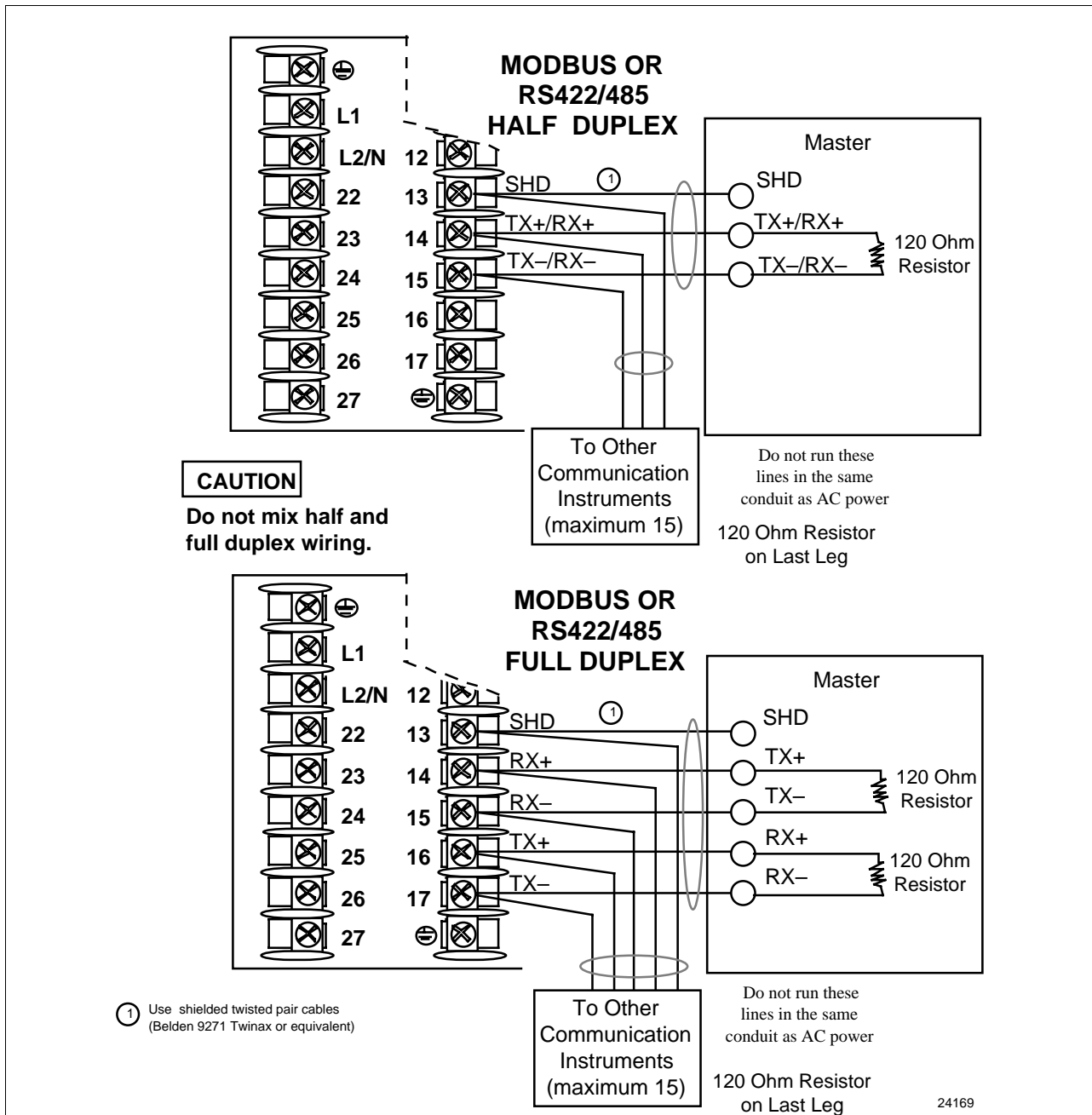
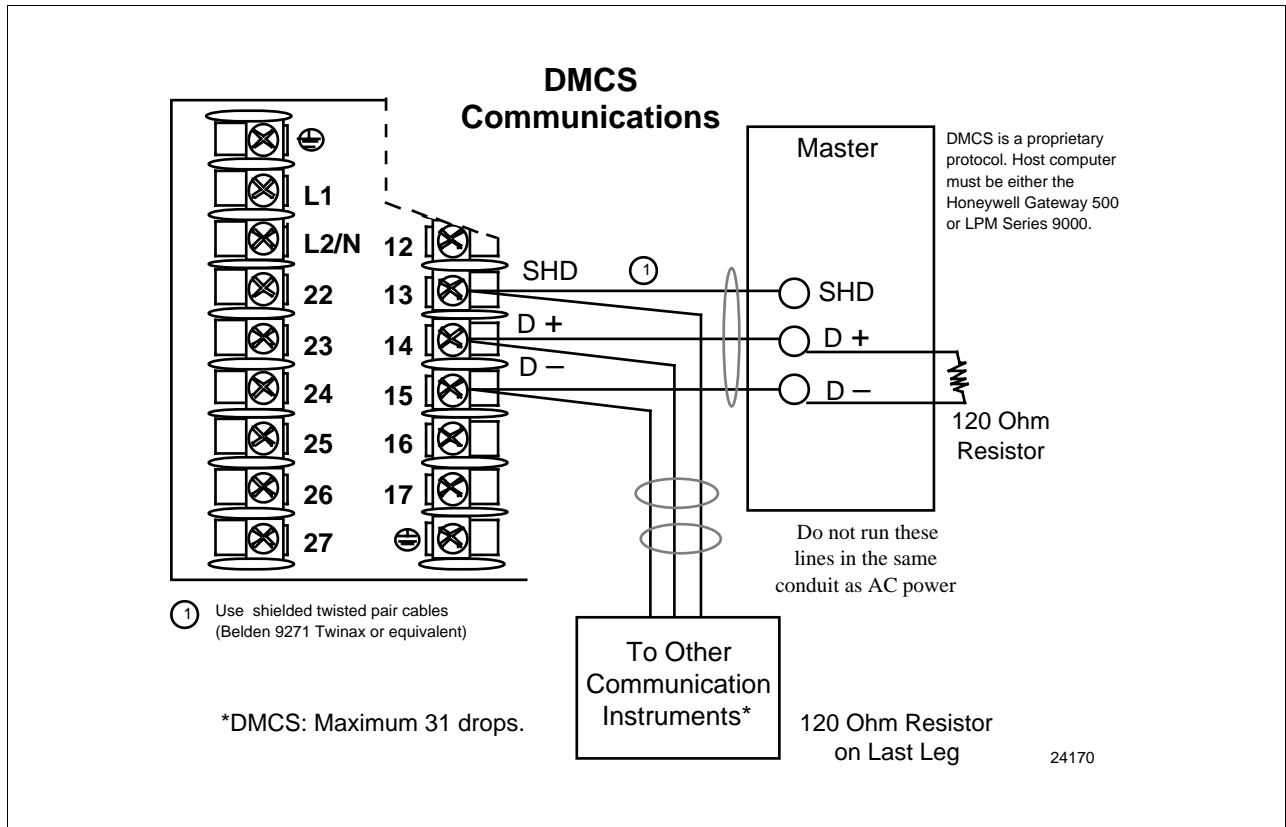


Figure 2-18 shows the wiring connections for the DMCS Communications option (Model DC330X-XX-4XX).

Figure 2-18 DMCS Communications Option Connections



**Transmitter power for
4-20 mA 2-wire
transmitter—open
collector alarm 2 output**

The wiring diagram example shown in Figure 2-19 (**Model DC330X-XT-XXX**) provides 30 Vdc at terminals 5 and 6 with the capability of driving up to 22 mA, as required by the transmitter which is wired in series.

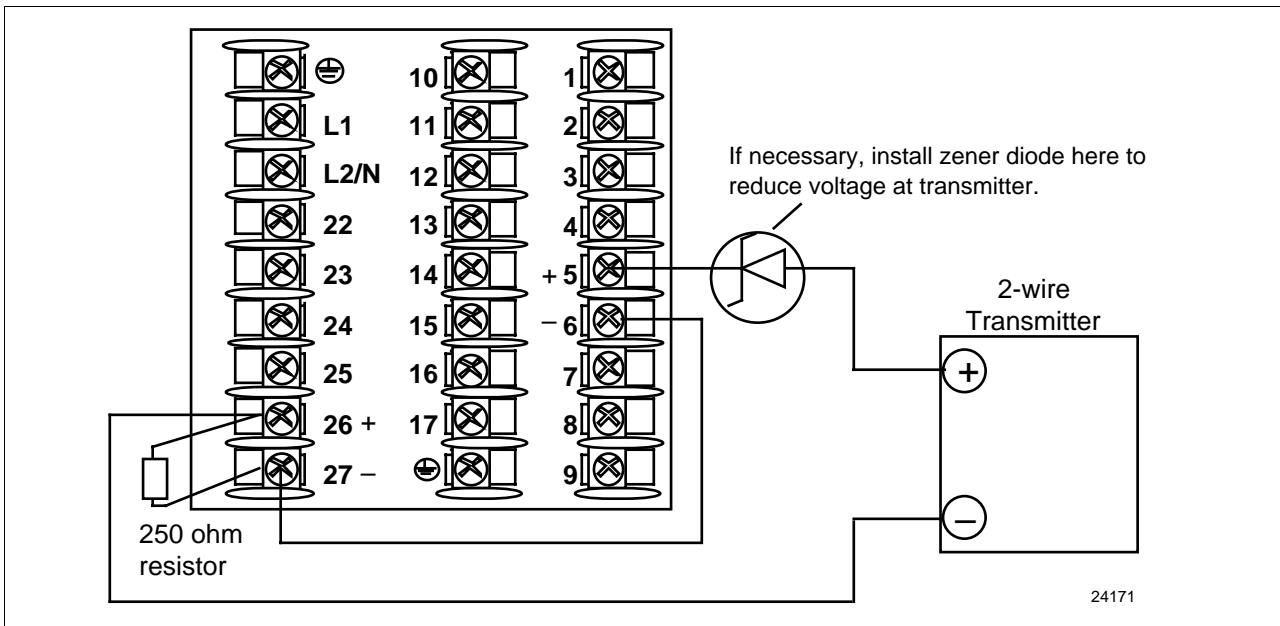
If the transmitter terminal voltage must be limited to less than 30 volts, you can insert a zener diode between the positive transmitter terminal and terminal 5. For example, an IN4733A zener diode will limit the voltage at the transmitter to 25 Vdc.

Configure:

A2S1TYPE = NONE

A2S2TYPE = NONE

Figure 2-19 Transmitter Power for 4-20 mA 2-wire Transmitter Using Open Collector Alarm 2 Output—Model DC330X-XT-XXX



Transmitter power for 4-20 mA 2-wire transmitter—auxiliary output

The wiring diagram example shown in Figure 2-20 (**Model DC330X-XX-2XX or DC330X-XX-5XX**) provides 30 Vdc at terminal 16 with the capability of driving up to 22 mA, as required by the transmitter which is wired in series.

If the transmitter terminal voltage must be limited to less than 30 volts, you can insert a zener diode between the positive transmitter terminal and terminal 16. For example, an IN4733A zener diode will limit the voltage at the transmitter to 25 Vdc.

Configure:

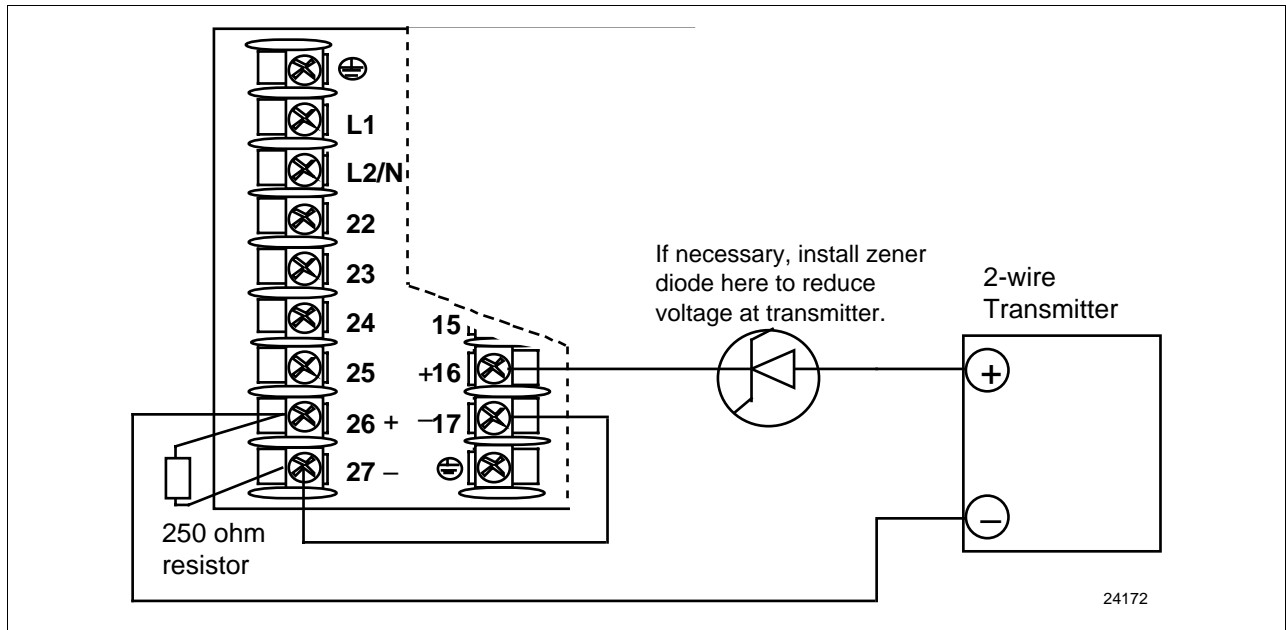
AUX OUT = OUTPUT

Calibrate the Auxiliary Output using the procedure given in Section 8.4 – Auxiliary Output Calibration.

ZERO VAL = 4095

SPAN VAL = 4095

Figure 2-20 Transmitter Power for 4-20 mA 2-wire Transmitter Using Auxiliary Output— Model DC330X-XX-2XX or DC330X-XX-5XX



2.6 Control and Alarm Relay Contact Information

Control relays

Table 2-7 lists the Control Relay contact information.

ATTENTION Control relays operate in the standard control mode; i.e., energized when output state is on.

Table 2-7 Control Relay Contact Information

Unit Power	Control Relay Wiring	Control Relay Contact	#1 or #2 Output Indicator Status
Off	N.O.	Open	Off
	N.C.	Closed	
On	N.O.	Open Closed	Off On
	N.C.	Closed Open	Off On

Alarm relays

Table 2-8 lists the Alarm Relay contact information.

ATTENTION Alarm relays are designed to operate in a failsafe mode; i.e., **de-energized during alarm state**. This results in alarm actuation when power is OFF or when initially applied, until the unit completes self diagnostics. If the unit loses power, the alarms will function.

Table 2-8 Alarm Relay Contact Information

Unit Power	Alarm Relay Wiring	Variable NOT in Alarm State		Variable in Alarm State	
		Relay Contact	Indicators	Relay Contact	Indicators
Off	N.O.	Open	Off	Open	Off
	N.C.	Closed		Closed	
On	N.O.	Closed	Off	Open	On
	N.C.	Open		Closed	

Section 3 – Configuration

3.1 Overview

Introduction

Configuration is a dedicated operation where you use straightforward keystroke sequences to select and establish (configure) pertinent control data best suited for your application.

What's in this section? The table below lists the topics that are covered in this section.

	Topic	Page
3.1	Overview	35
3.2	Configuration Prompts	36
3.3	How to Get Started	38
3.4	Configuration Tips	39
3.5	Configuration Procedure	40
3.6	Loop 1 Tuning Parameters Set Up Group	42
3.7	Loop 2 Tuning Parameters Set Up Group	44
3.8	Setpoint Ramp/Rate/Programming Set Up Group	45
3.9	Accutune Set Up Group	47
3.10	Algorithm Data Set Up Group	49
3.11	Output Algorithm Set Up Group	53
3.12	Input 1 Parameters Set Up Group	54
3.13	Input 2 Parameters Set Up Group	56
3.14	Input 3 Parameters Set Up Group	57
3.15	Loop 1 Control Parameters Set Up Group	58
3.16	Loop 2 Control Parameters Set Up Group	60
3.17	Options Parameters Set Up Group	62
3.18	Communications Parameters Set Up Group	64
3.19	Alarms Parameters Set Up Group	66
3.20	Display Parameters Set Up Group	69
3.21	Calibration Group	70
3.22	Maintenance Group	71
3.23	Status Group	72
3.24	Configuration Record Sheet for Basic and DMCS Models	73
3.25	Configuration Record Sheet for Extended Model	75

Prompts

To assist you in the configuration process, there are prompts that appear in the upper and lower displays. These prompts let you know what group of configuration data (Set Up prompts) you are working with and also, the specific parameters (Function prompts) associated with each group.

Figure 3-1 shows you an overview of the prompt hierarchy.

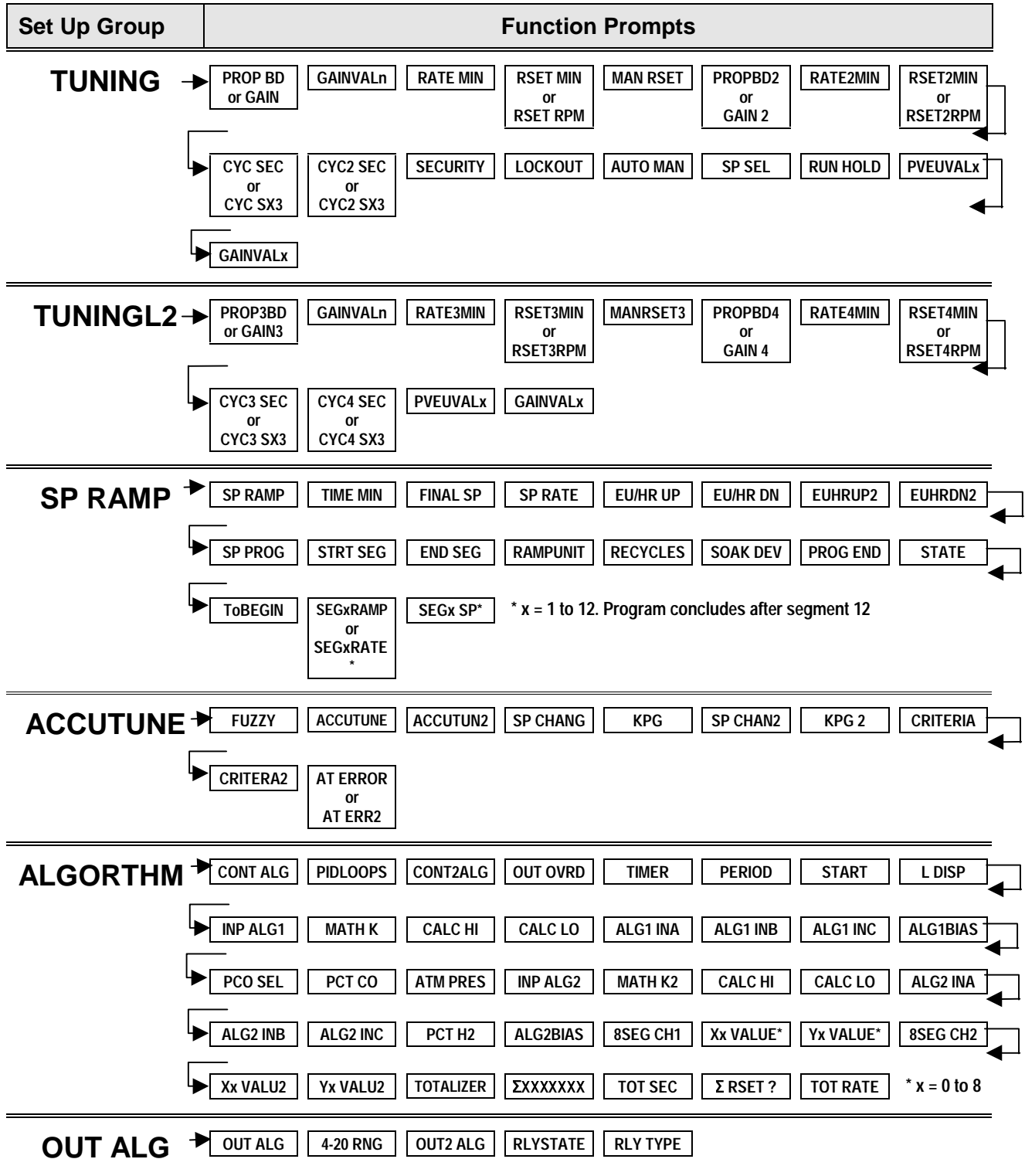
As you will see, the configuration data is divided into 15 main Set Up groups plus prompts for calibration and prompts that show the status of the continuous background tests that are being performed.

3.2 Configuration Prompts

Diagram: prompt hierarchy

Figure 3-1 shows an overview of the UDC 3300 Set Up prompts and their associated Function prompts. *Read from left to right.*

Figure 3-1 Overview of UDC 3300 Prompt Hierarchy



Set Up Group	Function Prompts							
INPUT 1	▶ IN1 TYPE	XMITTER1	ANALYTIC	IN1 HI	IN1 LO	RATIO 1	BIAS IN1	FILTER 1
	▶ BURNOUT1	EMISSIV1						
INPUT 2	▶ IN2 TYPE	XMITTER2	ANALYTIC	IN2 HI	IN2 LO	RATIO 2	BIAS IN2	FILTER 2
	▶ BURNOUT2	EMISSIV2						
INPUT 3	▶ IN3 TYPE	XMITTER3	IN3 HI	IN3 LO	RATIO 3	BIAS IN3	FILTER 3	
CONTROL	▶ PV SOURC	PID SETS	SW VALUE	LSP'S	RSP SRC	AUTOBIAS	SP TRACK	PWR MODE
	▶ PWR OUT	SP HiLIM	SP LoLIM	ACTION	OUT RATE	PCT/M UP	PCT/M DN	OUTHILIM
	▶ OUTLoLIM	I Hi LIM	I Lo LIM	DROPOFF	DEADBAND	OUT HYST	FAILMODE	FAILSAFE
	▶ MAN OUT	AUTO OUT	PBoRGAIN	MINorRPM				
CONTROL2	▶ PV 2 SRC	FORCE MA	PID SETS	SW VALUE	LSP'S	RSP SRC	AUTOBIAS	SPTRACK
	▶ SP HiLIM	SP LoLIM	ACTION	OUT RATE	PCT/M UP	PCT/M DN	OUTHILIM	OUTLoLIM
	▶ I Hi LIM	I Lo LIM	DROPOFF	DEADBAND	FAILMODE	FAILSAFE		
OPTIONS	▶ AUX OUT or CUR OUT2	4 mA VAL	20mA VAL	DIG IN 1	DIG1 COM	DIG IN 2	DIG2 COM	
COM	▶ ComSTATE	Com ADDR	ComADDR2	SHEDTIME	SHEDENAB	PARITY	BAUD	DUPLEX
	▶ WSFLOAT	TX DELAY	SHEDMODE	SHEDSP	UNITS	CSP RATO	CSP BIAS	CSP2RATO
	▶ CSP2BIAS	LOOPBACK						
ALARMS	▶ A1S1 VAL	A1S2 VAL	A2S1 VAL	A2S2 VAL	A1S1TYPE	A1S2 TYPE	A2S1TYPE	A2S2TYPE
	▶ A1S1 H L	A1S1 EV	A1S2 H L	A1S2 EV	A2S1 H L	A2S1 EV	A2S2 H L	A2S2 EV
	▶ AL HYST	ALM OUT1	BLOCK					
DISPLAY	▶ DECIMAL	DECIMAL2	TEMPUNIT	PWR FREQ	RATIO 2	LANGUAGE		
CALIB	▶ USED FOR FIELD CALIBRATION							
MAINTNCE	▶ TIME1	HRS.MIN1	TIME2	HRS.MIN2	TIME3	HRS.MIN3	COUNTER1	COUNTS1
	▶ COUNTER2	COUNTS2	COUNTER3	COUNTS3	RESET ID	RES TYPE		
STATUS	▶ VERNON	FAILSAFE	FAILSF 2	RAM TEST	CONFTEST	CALTEST	FACT CRC	

3.3 How To Get Started

Read the configuration tips	Read “ <i>Configuration Tips</i> ” shown on the next page. These tips will help you to easily and quickly accomplish the tasks at which you will be working when you configure your controller.
Read configuration procedure	Read “ <i>Configuration Procedure</i> ”. This procedure tells you how to access the Set Up groups, and the Function parameters within each of these groups that are shown in the Prompt Hierarchy in Figure 3-1.
Set up groups	The Set Up groups and Function parameters are listed in the order of their appearance. The list includes the name of the prompt, the range of setting selections available, the factory setting, and the section to reference for further details, if necessary.
Parameter explanations or definitions	<p>If you need a detailed explanation of any prompt listed, refer to <i>Section 4 – Configuration Parameter Definitions</i>.</p> <p>Section 4 lists the Set Up and Function prompts, the selections or range of settings that you can make for each, plus a detailed explanation or definition of each parameter.</p>
Configuration record sheet	Located on the last page of this section is a “ <i>Configuration Record Sheet</i> ”. When you make your configuration selections, record them on this sheet. Then you will have a record of how the controller was configured.

3.4 Configuration Tips

Introduction

Listed below in Table 3-1 are some tips that will help you enter the configuration data more quickly.

Table 3-1 Configuration Tips

Function	Tip
Displaying Groups	Use the SET UP key to display the Set Up groups. The group titles are listed in this section in the order that they appear in the controller.
Displaying Functions	Use the FUNCTION key to display the individual parameters under each group. The prompts are listed in the order of their appearance in each group.
Scrolling	<p>To get to a Set Up group prompt more quickly, hold the SET UP key in. To get to a Function prompt more quickly, hold the FUNCTION key in. The display will scroll through the parameters.</p> <p>ATTENTION The prompting scrolls at a rate of 2/3 seconds when the SET UP or FUNCTION key is held in. Also, ▲ ▼ keys will move group prompts forward or backward at a rate twice as fast.</p>
Changing values quickly	<p>When changing the value of a parameter, you can use a single ▲ or ▼ key. Hold the key in to increase the rate of change. Stop pressing the key for 1/2 second, then press again to restart at a slow rate.</p> <p>When changing the value of a parameter, you can adjust a more significant digit in the upper display by holding in one key ▲ or ▼, and pressing the other ▲ or ▼ at the same time. The adjustment will move one digit to the left. Press the key again and you will move one more digit to the left. (Holding the ▲ and ▼ keys down will change the value twice as quickly.)</p>
Restoring to the original value	When you change the value or selection of a parameter while in Set Up mode and decide not to enter it, press RUN/HOLD once, the original value or selection will be recalled.
Exiting SET UP mode	To exit Set Up mode, press the LOWER DISPLAY key. This returns the display to the same state it was in immediately preceding entry into the Set Up mode.
Timing out from Set Up mode	If you are in Set Up mode and do not press any keys for 30 seconds, the controller will time out and revert to the mode and display that was being used prior to entry into Set Up mode.
Key Error	<p>When a key is pressed and the prompt "KEY ERROR" appears in the lower display, it will be for one of the following reasons:</p> <ul style="list-style-type: none"> • parameter not available • not in Set Up mode, press SET UP key first • key malfunction, do keyboard test (operation) • Individual key locked out

3.5 Configuration Procedure

Introduction

Each of the Set Up groups and their functions are pre-configured at the factory.

The factory settings are shown in Tables 3-3 through 3-18 which follow this procedure.

If you want to change any of these selections or values, follow the procedure in Table 3-2. This procedure tells you the keys to press to get to any Set Up group and any associated Function parameter prompt.

If you need a detailed explanation of any prompt, refer to *Section 4 – Configuration Parameter Definitions*.



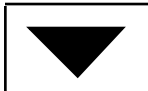
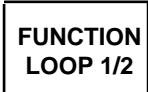


Procedure

Follow the procedure listed in Table 3-2 to access the Set Up groups and Function prompts.

ATTENTION The prompting scrolls at a rate of 2/3 seconds when the **SET UP** or **FUNCTION** key is held in. Also, [▲] [▼] keys will move group prompts forward or backward at a rate twice as fast.

Table 3-2 Configuration Procedure

Step	Operation	Press	Result
1	Select Set Up mode	SET UP	<p>Upper Display SET UP</p> <p>Lets you know you are in the configuration mode and a Set Up group title is being displayed in the lower display.</p> <p>Lower Display TUNING *</p> <p>This is the first Set Up group title.</p>
2	Select any Set Up group	SET UP	<p>Successive presses of the SET UP key will sequentially display the other Set Up group titles shown in the prompt hierarchy in Figure 3-1. You can also use the [▲] [▼] keys to scan the Set Up groups in both directions. Stop at the Set Up group title which describes the group of parameters you want to configure. Then proceed to the next step.</p>
3	Select a Function Parameter	FUNCTION LOOP 1/2	<p>Upper Display 1.0</p> <p>Shows you the current value or selection for the first function prompt of the particular Set Up group that you have selected.</p> <p>Lower Display GAIN</p> <p>Shows the first Function prompt within that Set Up group.</p> <p>Example displays show Set Up group "Tuning", Function prompt "Gain", and the value selected.</p>

Step	Operation	Press	Result
4	Select other Function Parameters		<p>Successive presses of the FUNCTION key will sequentially display the other function prompts of the Set Up group you have selected.</p> <p>Stop at the function prompt that you want to change, then proceed to the next step.</p>
5	Change the value or selection	 or 	<p>These keys will increment or decrement the value or selection that appears for the function prompt you have selected.</p> <p>See “Configuration Tips” for instructions to increase or decrease value quickly.</p> <p>Change the value or selection to meet your needs.</p> <p>If the display flashes, you are trying to make an unacceptable entry.</p>
6	Enter the value or selection	 or 	<p>This key selects another function prompt.</p> <p>This key selects another Set Up group.</p> <p>The value or selection you have made will be entered into memory after another key is pressed.</p>
7	Exit Configuration		<p>This exits configuration mode and returns the controller to the same state it was in immediately preceding entry into the Set Up mode. It stores any changes you have made.</p>

3.6 Loop 1 Tuning Parameters Set Up Group

Function prompts Table 3-3 lists all the function prompts in the Tuning Set Up group. How the Algorithm and Control Set Up groups are configured determines which prompts will appear.

Table 3-3 Tuning Group Function Prompts

Function Prompt <small>Lower Display</small>	Function Name	Selections or Range of Setting <small>Upper Display</small>	Factory Setting	Refer to
PROP BD or GAIN or GAINVALn***	Proportional Band or Gain	0.1 to 9999 % 0.001 to 1000	-- 1.000	Section 4.2
	or Gain Value being used by Gain Scheduling when enabled in Control Setup group "PID SETS"	Read Only	--	
RATE MIN	Rate in Minutes	0.00 to 10.00 minutes	0.00	
RSET MIN or RSET RPM	Reset in minutes/repeat or Reset in repeats/minute	0.02 to 50.00	1.00 --	
MAN RSET	Manual Reset	-100 to 100 % output	0	
PROPB2 or GAIN 2	Proportional Band 2 or Gain 2	0.1 to 9999 % 0.001 to 1000	-- 1.000	
RATE2MIN	Rate 2 in Minutes	0.00 to 10.00 minutes	0.00	
RSET2MIN or RSET2RPM	Reset 2 in minutes/repeat or Reset 2 in repeats/minute	0.02 to 50.00	1.00 --	
CYC SEC* or CYC SX3*	Cycle Time (Heat)	1 to 120	20	
CYC2 SEC* or CYC2 SX3*	Cycle Time (Cool)	1 to 120	20	
SECURITY	Security Code	0 to 4095	0	
LOCKOUT	Configuration Lockout	NONE CALIB + CONF + VIEW MAX	CALIB	
AUTO MAN**	Manual/Auto Key Lockout	DISABL ENABLE	ENABLE	
SP SEL**	Setpoint Select Key Lockout	DISABL ENABLE	ENABLE	

*Cycle times are in either 1 second or 1/3 second increments, depending upon the RLY TYPE configuration in the Output Algorithm Set Up group.

**Only appears if LOCKOUT = NONE.

***Requires Math software option

Function Prompt Lower Display	Function Name	Selections or Range of Setting Upper Display	Factory Setting	Refer to
RUN HOLD**	Run/Hold Key Lockout	DISABL ENABLE	ENABLE	Section 4.2
PVEUVAL1 PVEUVAL2 PVEUVAL3 PVEUVAL4 PVEUVAL5 PVEUVAL6 PVEUVAL7 PVEUVAL8	PV1 (through PV8) Value for Gain Scheduling	PV value within the PV limits. In engineering units	0	
GAINVAL1* GAINVAL2* GAINVAL3* GAINVAL4* GAINVAL5* GAINVAL6* GAINVAL7* GAINVAL8*	Gain 1 (through Gain 8) Value for Gain Scheduling	0.001 to 1000 floating Gain or Proportional Band	1.000	

***ATTENTION** If units of percent proportional band (PB) are selected under the Control Set Up prompt, function prompt PBoR**GAIN**, then the displayed values are in %PB, but the lower display will still show Gain.

****Only appears if LOCKOUT = NONE.**

3.7 Loop 2 Tuning Parameters Set Up Group (Cascade or Two Loops)

Function prompts Table 3-4 lists all the function prompts in the Tuning 2 Set Up group. This group is only displayed if the controller is configured for Cascade or 2-Loop control (prompt PIDLOOPS in Algorithm Data Set Up group).

Table 3-4 Tuning Loop 2 Group Function

Function Prompt <small>Lower Display</small>	Function Name	Selections or Range of Setting <small>Upper Display</small>	Factory Setting	Refer to
PROPBD3 or GAIN 3 or GAINVALn	Proportional Band 3 or Gain 3	0.1 to 9999 0.001 to 1000	-- 1.000	Section 4.3
	or Gain Value being used by Gain Scheduling when enabled	Read Only	--	
	RATE3MIN	Rate 3 in Minutes	0.00 to 10.00 minutes	
RSET3MIN or RSET3RPM	Reset 3 in minutes/repeat or Reset 3 in repeats/minute	0.02 to 50.00	1.00 --	
MANRSET3	Manual Reset 3	-100 to 100 % Output	0.0	
PROPBD4 or GAIN 4	Proportional Band 4 or Gain 4	0.1 to 9999 % 0.001 to 1000	-- 1.000	
		RATE4MIN	Rate 4 in Minutes	0.00 to 10.00 minutes
RSET4MIN or RSET4RPM	Reset 4 in minutes/repeat or Reset 4 in repeats/minute	0.02 to 50.00	1.00 --	
CYC3 SEC* or CYC3 SX3*	Cycle Time 3 (Heat)	1 to 120	20	
CYC4 SEC* or CYC4 SX3*	Cycle Time 4 (Cool)	1 to 120	20	
PVEUVAL1 PVEUVAL2 PVEUVAL3 PVEUVAL4 PVEUVAL5 PVEUVAL6 PVEUVAL7 PVEUVAL8	PV1 (through PV8) Value for Gain Scheduling	PV value within the PV limits. In engineering units	0	
GAINVAL1** GAINVAL2** GAINVAL3** GAINVAL4** GAINVAL5** GAINVAL6** GAINVAL7** GAINVAL8**	Gain 1 (through Gain 8) Value for Gain Scheduling	0.001 to 1000 floating Gain or Proportional Band	1.000	

*Cycle times are in either 1 second or 1/3 second increments, depending upon the RLY TYPE configuration in the Output Algorithm Set Up group.

****ATTENTION** If units of percent proportional band (PB) are selected under the Control Set Up prompt, function prompt PBoRGAIn, then the displayed values are in %PB, but the lower display will still show Gain.

3.8 SP Ramp, SP Rate, or SP Programming Set Up Group

Single Setpoint Ramp The Setpoint Ramp Set Up group contains the Function parameters that let you configure a single setpoint ramp to occur between the current local setpoint and a final setpoint over a time interval (SP RAMP).

Setpoint rate The Setpoint Ramp Set Up group also contains the function parameters that let you configure a specific rate of change for any Local Setpoint change (SP RATE). It includes selections for Rate Up and Rate Down.

Function prompts Table 3-5 lists all the function prompts in the SP Ramp Set Up group.

Table 3-5 SP Ramp Group Function Prompts

Function Prompt <small>Lower Display</small>	Function Name	Selections or Range of Setting <small>Upper Display</small>	Factory Setting	Refer to
<i>If SP Rate and SP Programming are disabled</i>				
SP RAMP	Single Setpoint Ramp Selection	DISABL ENABLE ENABL2 ENAB12	DISABL	Section 4.4
TIME MIN	Single Setpoint Ramp Time (SP ramp enabled)	0 to 255 minutes	3	
FINAL SP	Single Setpoint Final Setpoint (SP ramp enabled)	Enter a value within the setpoint limits.	1000	
<i>If SP Ramp and SP Programming are disabled</i>				
SP RATE	Setpoint Rate	DISABL ENABLE ENABL2 ENAB12	DISABL	
EU/HR UP	Rate Up Value for Loop 1 (SP Rate enabled)	0 to 9999 in engineering units per hour	0	
EU/HR DN	Rate Down Value for Loop 1 (SP Rate enabled)	0 to 9999 in engineering units per hour	0	
EU/HRUP2	Rate Up Value for Loop 2 (SP Rate enabled)	0 to 9999 in Units per Hour	0	
EU/HRDN2	Rate Down Value for Loop 2 (SP Rate enabled)	0 to 9999 in Units per Hour	0	
<i>If SP Ramp and SP Rate are disabled</i>				
SP PROG*	Setpoint Ramp/Soak Programming	DISABL ENABLE ENABL2 ENAB12 SP PROG must be enabled to view the remaining prompts.	DISABL	
STRT SEG	Start Segment Number	1 to 11	—	
END SEG	End Segment Number	2 to 12 Always end in a soak segment (2, 4, ... 12)	—	
RAMPUNIT	Engineering Units for Ramp Segments	TIME (hours.minutes) EU/MIN (engineering units/minute) EU/HR (engineering units/hour)	TIME	

Function Prompt Lower Display	Function Name	Selections or Range of Setting Upper Display	Factory Setting	Refer to
RECYCLES	Number of Program Recycles	0 to 99 recycles	—	Section 4.4
SOAK DEV	Guaranteed Soak Deviation Value	0 to 99 The number selected will be the PV value (in engineering units) above or below the setpoint outside of which the timer halts.	—	
PROG END	Program Termination State	LASTSP (Hold at last setpoint in the program) F SAFE (Manual mode/Failsafe output)	—	
STATE	Program State at Program End	DISABL HOLD	—	
KEYRESET	Reset/Rerun SP Program	DISABL TOBEGN RERUN	DISABL	
HOTSTART	Hot Start	DISABL ENABL	DISABL	
SEG1RAMP or SEG1RATE	Segment #1 Ramp Time or Segment #1 Ramp Rate	0-99 hours.0-59 minutes Engineering units/minute or Engineering units/hour Select TIME, EU/MIN, or EU/HR at prompt RAMPUNIT. All ramps will use the same selection.	—	
SEG2 SP	Segment #2 Soak Setpoint Value	Within the Setpoint limits	—	
SEG2TIME	Segment #2 Soak Duration	0-99 hours.0-59 minutes	—	
SEG3RAMP or SEG3RATE SEG4 SP SEG4TIME SEG5RAMP or SEG5RATE SEG6 SP SEG6TIME SEG7RAMP or SEG7RATE SEG8 SP SEG8TIME SEG9RAMP or SEG9RATE SG10 SP SG10TIME SG11RAMP or SG11RATE SG12 SP SG12TIME	Same as above	Selections are same as above.	—	

*Requires SP Programming option

3.9 Accutune Set Up Group

Introduction

The Accutune Set Up group offers these selections:

- FUZZY

Fuzzy Overshoot Suppression—Uses fuzzy logic to suppress or eliminate any overshoot that may occur when the PV approaches setpoint.

- TUNE

Demand Tuning—The tuning process is initiated through the operator interface keys or via a digital input (if configured). The algorithm then calculates new tuning parameters and enters them in the tuning group.

TUNE does operate with 3 Position Step Control.

- SP*

SP Tuning—SP tuning continuously adjusts the PID parameters in response to setpoint changes. You can select tuning on minimum setpoint changes of 5 % up to 15 % span. Perform SP tuning after you have configured the controller.

SP tuning does not operate with 3 Position Step Control algorithm.

- TUN+PV*

or

SP+PV*

PV Tuning—The (TUNE) Demand Tuning or the (SP) Setpoint Tuning portions of these selections work as stated above. **PV Adapt** will occur during Process Variable (PV) disturbances (0.3 % span or larger) which result from non-linearities, process dynamics, load changes, or other operating conditions. When this condition exists, the controller monitors the process response for 1 and 1/2 process cycles around the setpoint to determine whether there has been a true process change or a momentary upset.

Process retuning occurs as the process dynamics are learned. When the process is being learned with possible retune, a **t** is shown in the upper left display digit.

*SP + PV Tuning not available on Basic Model DC330B.

Function prompts

Table 3-6 lists the function prompts in the Accutune Set Up group.

Table 3-6 Accutune Group Function Prompts

Function Prompt <small>Lower Display</small>	Function Name	Selections or Range of Setting <small>Upper Display</small>	Factory Setting	Refer to
FUZZY	Fuzzy Overshoot Suppression	DISABL ENABLE ENABL2 ENAB12	DISABL	Section 4.5
ACCUTUNE	Accutune—Loop 1	DISABL TUNE (Demand Tuning) SP (SP Tuning) TUN+PV SP+PV	DISABL	
ACCUTUN2	Accutune—Loop 2	DISABL TUNE (Demand Tuning) SP (SP Tuning) TUN+PV SP+PV	DISABL	
SP CHANG*	Setpoint Change Value—Loop 1	5 to 15 % Input Span	10	
KPG*	Process Gain—Loop 1	0.10 to 10.00	1.00	
SP CHAN2*	Setpoint Change Value – Loop 2	5 to 15 % Input Span	10	
KPG 2*	Process Gain – Loop 2	0.10 to 10.00	1.00	
CRITERIA*	Tuning Criteria—Loop 1	NORMAL FAST	FAST	
CRITERA2*	Tuning Criteria – Loop 2	NORMAL FAST	FAST	
AT ERROR or AT ERR 2 (depending on Loop)	Accutune Error Codes	Read Only RUNING (Accutune process in operation) NONE OUTLIM IDFAIL ABORT LOW PV	--	

*Applies to SP and SP+PV only.

3.10 Algorithm Data Set Up Group

Introduction

This data deals with various algorithms residing in the controller:

- Control algorithms,
- Input Math algorithms,
- selecting the 1 or 2 PID Loops,
- Output Override,
- 2 Eight Segment Characterizers,
- the Timer function, and
- Totalizer function.
- Gain Scheduler

ATTENTION Math option (two algorithms, two characterizers, totalizer) and Two Loops of Control are only available on Expanded Model DC330E.

Function prompts

Table 3-7 lists all the function prompts in the Algorithm Set Up group.

Table 3-7 Algorithm Group Function Prompts

Function Prompt <small>Lower Display</small>	Function Name	Selections or Range of Setting <small>Upper Display</small>	Factory Setting	Refer to
CONT ALG	Control Algorithm	ON-OFF PID A PID B PD+MR 3PSTEP	PID A	Section 4.6
PIDLOOPS (NOTE 1)	PID Loop Selection	1 LOOP 2LOOPS CASCAD	1 or 2	
CONT2ALG (NOTE 1)	Control 2 Algorithm	PID A PID B PD+MR	PID A	
OUT OVRD (NOTE 2)	Output Override Select	DISABL HI SEL LO SEL	DISABL	
TIMER	Timer Enable/Disable	ENABLE DISABL	DISABL	
PERIOD*	Timeout Period	00:00 to 99:59	00:01	
START*	Start Initiation	KEY (Run/Hold key) ALARM2	KEY	
L DISP*	Lower Display Selection	TI REM (time remaining) E time (elapsed time)	TI REM	

*Prompt appears only when Timer is enabled.

NOTE 1: Two Loops and Cascade are only available on Expanded Model DC330E.

NOTE 2: Does not apply to Three Position Step Control.

Function Prompt Lower Display	Function Name	Selections or Range of Setting Upper Display		Factory Setting	Refer to
INP ALG1	Input 1 Algorithm (formulas are located in Section 4) ATTENTION All Input Algorithms operate in engineering units except feedforward which operates in percent of output units. PV or RSP source in the Control Set Up group must be set to IN AL1.	NONE W AVG F FWRD FFWDMu RELHUM SUMMER HI SEL LO SEL √MuDIV √MULT	MuDIV MULT CARB A CARB B CARB C CARB D FCC DEW PT OXYGEN	NONE	Section 4.6
MATH K	Weighted Average Ratio or K Constant for Math Selections	0.001 to 1000 floating		--	
CALC HI	Calculated Variable High Scaling Factor for Input Algorithm	-999. to 9999. floating (in engineering units)		--	
CALC LO	Calculated Variable Low Scaling Factor for Input Algorithm	-999. to 9999. floating (in engineering units)		--	
ALG1 INA	Input Algorithm 1 Input A Selection	INP 1 INP 2 LP1OUT LP2OUT	IN AL1 IN AL2 INP 3	--	
ALG1 INB	Input Algorithm 1 Input B Selection	INP 1 INP 2 LP1OUT LP2OUT	IN AL1 IN AL2 INP 3	--	
ALG1 INC	Input Algorithm 1 Input C Selection	NONE INPUT 1 INPUT 2 LP1OUT	LP2OUT IN AL1 IN AL2 INP 3	--	
PCO SEL	Percent Carbon Source (Input 3 must be enabled)	DISABL ONLINE		DISABL	
PCT CO	Percent Carbon Monoxide	0.020 to 0.350 (fractional percent of CO)		0.200	
ATM PRES	Atmospheric Pressure Compensation	590.0 to 760.0 (mm Hg)		760.0	
ALG1BIAS	Input Algorithm1 Bias	-999 to 9999 floating (in engineering units)		0.000	
INP ALG2*	Input 2 Algorithm (formulas are located in Section 4) ATTENTION All Input Algorithms operate in engineering units except feedforward which operates in percent of range units.	NONE W AVG F FWD FFWDMu A-B/C HI SEL	LO SEL √MuDIV √MULT MuDIV MULT DEW PT	NONE	
MATH K2	Weighted Average Ratio or K Constant for Math Selections	0.001 to 1000		--	

Function Prompt Lower Display	Function Name	Selections or Range of Setting Upper Display	Factory Setting	Refer to
CALC HI	Calculated Variable High Scaling Factor for Input Algorithm 2	-999. To 9999. Floating (in engineering units)	--	
CALC LO	Calculated Variable Low Scaling Factor for Input Algorithm 2	-999. To 9999. Floating (in engineering units)	--	
ALG2 INA	Input Algorithm 2 Input A Selection	INP 1 IN AL1 INP 2 IN AL2 LP1OUT INP 3 LP2OUT	--	
ALG2 INB	Input Algorithm 2 Input B Selection	INP 1 IN AL1 INP 2 IN AL2 LP1OUT INP 3 LP2OUT	--	
ALG2 INC	Input Algorithm 2 Input C Selection	NONE LP2OUT INP 1 IN AL1 INP 2 IN AL2 LP1OUT INP 3	--	
PCT H2	Hydrogen Content for Dewpoint	1.0 to 99.0 %	1.0	
ALG2 BIAS	Input Algorithm2 Bias	-999 to 9999 floating (in engineering units)	0.000	
8SEG CH1*	Eight Segment Characterizer If Characterizer 1 is enabled, the following Xn VALUE and Yn VALUE parameters appear.	DISABL INPUT1 INPUT2 L1 OUT L2 OUT	DISABL	
X0 VALUE X1 VALUE X2 VALUE X3 VALUE X4 VALUE X5 VALUE X6 VALUE X7 VALUE X8 VALUE	Xn Input Value (X Axis) (n = 0 through 8)	0 to 99.99 %	0	
Y0 VALUE Y1VALUE Y2VALUE Y3VALUE Y4VALUE Y5VALUE Y6VALUE Y7VALUE Y8 VALUE	Yn Output Value (Y Axis) (n = 0 through 8)	0 to 99.99 %	0	
8SEG CH2*	Eight Segment Characterizer 2 If Characterizer 2 is enabled, the following Xn VALU2 and Yn VALU2 parameters appear.	DISABL INPUT1 INPUT2 L1 OUT L2 OUT	DISABL	

Function Prompt Lower Display	Function Name	Selections or Range of Setting Upper Display	Factory Setting	Refer to
X0 VALU2 X1 VALU2 X2 VALU2 X3 VALU2 X4 VALU2 X5 VALU2 X6 VALU2 X7 VALU2 X8 VALU2	Xn Input Value (X Axis) (n = 0 through 8)	0 to 99.99 %	0	
Y0 VALU2 Y1 VALU2 Y2 VALU2 Y3 VALU2 Y4 VALU2 Y5 VALU2 Y6 VALU2 Y7 VALU2 Y8 VALU2	Yn Output Value (Y Axis) (n = 0 through 8)	0 to 99.99 %	0	
TOTALIZE*	Totalization Function	DISABL INPUT1 IN AL1 IN AL2	DISABL	
ΣXXXXXXX	Current Scale Factor (upper display) Actual Current Totalized Value (lower display)	Σ*En Where: n = Totalizer Scale Factor Value	--	
TOT SCAL	Totalizer Scale Factor	*E0 *E1 *E2 *E3 *E4 *E5 *E6	E0	
TOT SEC	Totalizer Reset Lock	UNLOCK LOCK	UNLOCK	
Σ RSET ?	Totalizer Reset	NO YES	NO	
TOT RATE	Totalizer Rate of Integration	SECOND (once per second) MINUTE (once per minute) HOUR (once per hour) DAY (once per day) ML/DAY (millions per day)	SECOND	
*Not available on DC330B				

3.11 Output Algorithm Parameters Set Up Group

Introduction This data deals with various Output types that are available for use in the controller. It also lists the Digital Output Status, the Current Duplex functionality, and Relay Time Cycle increments.

Function prompts Table 3-8 lists all the function prompts in the Output Algorithm Set Up group.

Table 3-8 Output Algorithm Group Function Prompts

Function Prompt Lower Display	Function Name	Selections or Range of Setting Upper Display	Factory Setting	Refer to
OUT ALG	Loop 1 Output Algorithm	TIME Time Simplex CURRNT Current Simplex POSITN Position Proportional TIME D Time Duplex CUR D Current Duplex CUR TI Current/Time Duplex TI CUR Time/Current Duplex	CURRNT	Section 4.7
4-20 RNG	Current Duplex Range	100PCT 50 PCT	100PCT	
OUT2 ALG*	Loop 2 Output Algorithm	NONE TIME CURRNT CUR D CUR TI TI CUR	CURRNT	
RLYSTATE	Digital Output State at 0 % Output	1OF2OF (Output relays 1 and 2 are both de-energized) 1ON2OF (Output relay 1 is energized, output relay 2 is de-energized) 1OF2ON (Output relay 1 is de-energized, output relay 2 is energized) 1ON2ON (Output relays 1 and 2 are both energized)	1OF2ON	
RLY TYPE	Relay Cycle Time Increments	MECHAN (Cycle time in one second increments) SOL ST (Cycle time in 1/3 second increments: 1 = .33 seconds, 120 = 40 seconds)	MECHAN	

*Not available on DC330B

3.12 Input 1 Parameters Set Up Group

Introduction This data deals with various parameters required to configure Input 1.

Function prompts Table 3-9 lists all the function prompts in the Input 1 Set Up group.

Table 3-9 Input 1 Group Function Prompts

Function Prompt Lower Display	Function Name	Selections or Range of Setting Upper Display	Factory Setting	Refer to
IN1 TYPE	Input 1 Actuation Type	DISABL W TC H B TC W TC L E TC H 100 PT E TC L 100 LO J TC H 200 PT J TC L 500 PT K TC H RAD RH K TC L RAD RI NNM H 0-20mA NNM L 4-20mA NM90 H 0-10mV NM90 L 0-50mV NIC TC 0-5 V R TC 1-5 V S TC 0-10 V T TC H CARBON T TC L OXYGEN	0-10mV	Section 4.8
XMITTER1	Transmitter Characterization	B TC S TC E TC H T TC H E TC L T TC L J TC H W TC H J TC L W TC L K TC H 100 PT K TC L 100 LO NNM H 200 PT NNM L 500 PT NM90 H RAD RH NM90 L RAD RI NIC TC LINEAR R TC SQROOT ANALYT*	LINEAR	
ANALYTIC*	Analytic Selections XMITTER1 must be set to ANALYT for this prompt to appear	NONE PH ORP mV CONDmS CONDuS RSTVM^ TDS PPm TDS PPb CONCPt DO PPm DO PPb	NONE	
IN1 HI	Input 1 High Range Value (Linear Inputs only)	-999. To 9999. Floating (in engineering units)	1000	
IN1 LO	Input 1 Low Range Value (Linear Inputs only)	-999. to 9999. floating (in engineering units)	0	
RATIO 1	Input 1 Ratio	-20.00 to 20.00 (floats to 3 decimal places)	1.000	

Function Prompt Lower Display	Function Name	Selections or Range of Setting Upper Display	Factory Setting	Refer to
BIAS IN1	Input 1 Bias	-999. to 9999. (in engineering units)	0	
FILTER 1	Input 1 Filter	0 to 120 seconds	0	
BURNOUT1	Burnout Protection	NONE UP DOWN NO_FS	NONE	
EMISSIV1	Emissivity	0.01 to 1.00	0.00	
*Not available on DC330B				

3.13 Input 2 Parameters Set Up Group

Introduction This data deals with various parameters required to configure Input 2.

Function prompts Table 3-10 lists all the function prompts in the Input 2 Set Up group.

Table 3-10 Input 2 Group Function Prompts

Function Prompt Lower Display	Function Name	Selections or Range of Setting Upper Display	Factory Setting	Refer to		
IN2 TYPE	Input 2 Actuation Type	DISABL B TC E TC H E TC L J TC H J TC L K TC H K TC L NNM H NNM L NM90 H	NM90 L NIC TC R TC S TC T TC H T TC L W TC H W TC L 100 PT 100 LO 200 PT	500 PT RAD RH RAD RI 0-20mA 4-20mA 0-10mV 0-50mV 0-5 V 1-5 V 0-10 V SLIDEW	0-10mV	Section 4.9
XMITTER2	Transmitter Characterization	B TC E TC H E TC L J TC H J TC L K TC H K TC L NNM H NNM L NM90 H NM90 L NIC TC R TC	S TC T TC H T TC L W TC H W TC L 100 PT 100 LO 200 PT 500 PT RAD RH RAD RI LINEAR SQROOT ANALYT*	LINEAR		
ANALYTIC*	Analytic Selections XMITTER2 must be set to ANALYT for this prompt to appear	NONE PH ORP mV CONDmS CONDuS RSTVM^ TDS PPM TDS PPb CONCPt DO PPM DO PPb		NONE		
IN2 HI	Input 2 High Range Value (Linear Inputs only)	-999. to 9999. floating (in engineering units)		1000		
IN2 LO	Input 2 Low Range Value (Linear Inputs only)	-999. to 9999. floating (in engineering units)		0		
RATIO 2	Input 2 Ratio	-20.00 to 20.00		1.000		
BIAS IN2	Input 2 Bias	-999. to 9999. (in engineering units)		0		
FILTER 2	Input 2 Filter	0 to 120 seconds		0		
BURNOUT2	Burnout Protection	NONE UP DOWN NO_FS		NONE		
EMISSIV2	Emissivity	0.01 to 1.00		0.00		

*Not available on DC330B

3.14 Input 3 Parameters Set Up Group

Introduction This data deals with various parameters required to configure Input 3.

Function prompts Table 3-11 lists all the function prompts in the Input 3 Set Up group.

Table 3-11 Input 3 Group Function

Function Prompt <small>Lower Display</small>	Function Name	Selections or Range of Setting <small>Upper Display</small>	Factory Setting	Refer to
IN3 TYPE*	Input 3 Actuation Type	DISABL 0-20mA 4-20mA 0-5 V 1-5 V	DISABL	Section 4.10
XMITTER3	Transmitter Characterization	B TC S TC E TC H T TC H E TC L T TC L J TC H W TC H J TC L W TC L K TC H 100 PT K TC L 100 LO NNM H 200 PT NNM L 500 PT NM90 H RAD RH NM90 L RAD RI NIC TC LINEAR R TC SQROOT	LINEAR	
IN3 HI	Input 3 High Range Value (Linear Inputs only)	-999. to 9999. floating (in engineering units)	1000	
IN3 LO	Input 3 Low Range Value (Linear Inputs only)	-999. to 9999. floating (in engineering units)	0	
RATIO 3	Input 3 Ratio	-20.00 to 20.00	1.000	
BIAS IN3	Input 3 Bias	-999. to 9999. (in engineering units)	0	
FILTER 3	Input 3 Filter	0 to 120 seconds	0	
*Not available on DC330B				

3.15 Loop 1 Control Parameters Set Up Group

Introduction The functions listed in this group define how the Single Loop process controller or Loop 1 of a Two Loop process controller will control the process.

Function prompts Table 3-12 lists all the function prompts in the Control Set Up group.

Table 3-12 Control Group Function Prompts

Function Prompt <small>Lower Display</small>	Function Name	Selections or Range of Setting <small>Upper Display</small>			Factory Setting	Refer to
PV SOURC	Process Variable Source	INP 1 INP 2	IN AL1 IN AL2	INP 3	INP 1	Section 4.11
PID SETS	Tuning Parameter Sets	1 ONLY 2KEYBD 2PV SW 2SP SW GAIN S (Gain scheduling automatically disables Accutune for this loop)			1 ONLY	
SW VALUE	Automatic Switchover Value	Value in engineering units within PV or SP range limits			0.00	
LSP'S	Local Setpoint Source	1 ONLY TWO THREE (Selection automatically disables RSP SRC)			1 ONLY	
RSP SRC	Remote Setpoint Source	NONE INP 2	IN AL1 IN AL2	INP 3	NONE	
AUTOBIAS	Automatic Bias	ENABLE DISABL			DISABL	
SP TRACK	Local Setpoint Tracking	NONE PV RSP			NONE	
PWR MODE	Power Up Mode Recall	MANUAL A LSP A RSP AM SP AM LSP			MANUAL	
PWR OUT	TPSC Output Start-up Mode	LAST F'SAFE			LAST	
SP HiLIM	Setpoint High Limit	0 to 100 % of span input in engineering units			1000	
SP LoLIM	Setpoint Low Limit	0 to 100 % of span input in engineering units			0	
ACTION	Control Output Direction	DIRECT REVRSE			REVRSE	

Function Prompt Lower Display	Function Name	Selections or Range of Setting Upper Display	Factory Setting	Refer to
OUT RATE ATTENTION Does not apply to 3 Position Step Control algorithm.	Output Change Rate	ENABLE DISABL	DISABL	Section 4.11
PCT/M UP	Output Rate Up Value	0 to 9999 % per minute	0	
PCT/M DN	Output Rate Down Value	0 to 9999 % per minute	0	
OUTHILIM	High Output Limit	-5.0 to 105 % of output	100	
OUTLoLIM	Low Output Limit	-5.0 to 105 % of output	0.0	
I Hi LIM	High Reset Limit	Within the range of the output limits	100.0	
I Lo LIM	Low Reset Limit	Within the range of the output limits	0.0	
DROPOFF	Controller Dropoff Value	-5 to 105 % of output	0	
DEADBAND	Output Relay Deadband	<i>Time Duplex:</i> -5.0 to 25.0 % <i>On/Off Duplex:</i> 0.0 to 25.0 % <i>Position Prop. and 3P Step:</i> 0.5 to 5.0 %	1.0	
OUT HYST	Output Relay Hysteresis	0.0 to 100.0 % of PV Span for On/Off control.	0.5	
FAILMODE	Failsafe Mode	NO LAT LATCH	NO LAT	
FAILSAFE	Failsafe Output Value for all outputs except 3P Step	Set within the range of the output limits. 0 to 100 %	0.0	
	Failsafe Output Value for 3P Step	0 PCT (motor goes to closed position) 100PCT (motor goes to open position)	--	
SW_FAIL	PDMR/Position Proportional motor position when slidewire fails	0 PCT (motor goes to closed position) 100PCT (motor goes to open position)		
MAN OUT	Power-up Preset Output for Manual Output	Within the range of output limits	--	
AUTO OUT	Power-up Preset Output for Automatic Output	Within the range of output limits	--	
PBoR GAIN	Proportional Band or Gain Units	PB PCT GAIN	GAIN	
MINoRPM	Reset Units	RPM MIN	MIN	

3.16 Loop 2 Control Parameters Set Up Group

Introduction The functions listed in this group define how Loop 2 of a Two Loop process controller will control the process.

Only available on Expanded Controller Model DC330E-XX-XXX.

Function prompts Table 3-13 lists all the function prompts in the Control 2 Set Up group.

Table 3-13 Control 2 Group Function Prompts

Function Prompt <small>Lower Display</small>	Function Name	Selections or Range of Setting <small>Upper Display</small>	Factory Setting	Refer to
PV 2 SRC	Process Variable Source	INP 1 INP 2 IN AL1 IN AL2 INP 3	INP 2	Section 4.12
FORCE MA	Force Manual	DISABL LINK12	DISABL	
PID SETS	Tuning Parameter Sets	1 ONLY 2KEYBD 2PV SW 2SP SW GAIN S (Gain scheduling automatically disables Accutune for this loop)	1 ONLY	
SW VALUE	Automatic Switchover Value	Value in engineering units within PV or SP range limits	0.00	
LSP'S	Local Setpoint Source	1 ONLY TWO THREE (Selection automatically disables RSP SRC)	1 ONLY	
RSP SRC	Remote Setpoint Source	NONE INP 2 IN AL1 IN AL2 INP 3	NONE	
AUTOBIAS	Automatic Bias	ENABLE DISABL	DISABL	
SPTRACK	Local Setpoint Tracking	NONE PV RSP	NONE	
SP HiLIM	Setpoint High Limit	0 to 100 % of PV span input in engineering units	1000	
SP LoLIM	Setpoint Low Limit	0 to 100 % of PV span input in engineering units	0	
ACTION	Control Output Direction	DIRECT REVRSE	REVRSE	

Function Prompt Lower Display	Function Name	Selections or Range of Setting Upper Display	Factory Setting	Refer to
OUT RATE	Output Change Rate	ENABLE DISABL	DISABL	Section 4.12
PCT/M UP	Output Rate Up Value	0 to 9999 % per minute	0	
PCT/M DN	Output Rate Down Value	0 to 9999 % per minute	0	
OUTHILIM	High Output Limit	-5 to 105 % of output	100	
OUTLoLIM	Low Output Limit	-5 to 105 % of output	0	
I HiLIM	High Reset Limit	Within the range of the output limits	100.0	
I LoLIM	Low Reset Limit	Within the range of the output limits	0.0	
DROPOFF	Controller Dropoff Value	-5 to 105 % of output	0	
DEADBAND	Output Relay Deadband	-5.0 to 5.0 %	1.0	
FAILMODE	Failsafe Mode	NO LAT LATCH	NO LAT	
FAILSAFE	Failsafe Output Value	Set within the range of the output limits. 0 to 100 %	0	

3.17 Options Set Up Group

Introduction This data deals with various options that are available with your controller. If your controller does not have any of these options the prompts will not appear.

Function prompts Table 3-14 lists all the function prompts in the Options Set Up group.

Table 3-14 Options Group Function Prompts

Function Prompt <small>Lower Display</small>	Function Name	Selections or Range of Setting <small>Upper Display</small>	Factory Setting	Refer to
AUX OUT or CUR OUT2*	Auxiliary Output One Loop Selection or Auxiliary Output Two Loops/Cascade Selection	DISABL LSP 1 INP 1 IN AL1 INP 2 IN AL2 INP 3 PV 2 CBOUT DEV 2 PV OUTPT2 DEV SP L2 OUTPUT LSP1 2 SP CBOUT2	DISABL	Section 4.13
4mA VAL	Auxiliary Output Low Scaling Factor	Low scale value to represent 4 mA. Value in % for output, all others in engineering units.	0.0	
20mA VAL	Auxiliary Output High Scaling Factor	High scale value to represent 20 mA. Value in % for output, all others in engineering units.	0	
DIG IN 1	Digital Input 1 Selections	NONE SPinit TO MAN TRACK1 TO LSP TRACK2 TO 2SP ToOUT2 TO 3SP TO RSP TO DIR D L1/2 ToHOLD RST FB ToPID2 ToPURG PV 2IN LoFIRE PV 3IN MAN LT RERUN RESot TO RUN ToBEGN HealthWatch option STOP I prompts*: MAN FS RESETT1 ToLOCK RESETT2 ToAout RESETT3 TIMER R ALL T AM STA RESETC1 ToTUNE RESETC2 RESETC3 R ALL C RALLTC	NONE	

Function Prompt Lower Display	Function Name	Selections or Range of Setting Upper Display	Factory Setting	Refer to
DIG1 COM	Digital Input 1 Combinations	DISABL +PID2 +ToDIR +ToSP2 +DISAT +ToSP1 +RUN	DISABL	Section 4.13
DIG IN 2	Digital Input 2 Selections	Same as DIG IN 1	NONE	
DIG2 COM	Digital Input 2 Combinations	Same as DIG1 COM	DISABL	
*Not available on DC330B				

3.18 Communications Set Up Group

Introduction

This data deals with the Communications option that is available with your controller. This option allows the controller to be connected to a host computer via an RS422/485 or Modbus protocol.

If your controller does not have this option the prompts will not appear.

Function prompts

Table 3-15 lists all the function prompts in the Communications Set Up group.

Table 3-15 Communications Group Function Prompts

Function Prompt <small>Lower Display</small>	Function Name	Selections or Range of Setting <small>Upper Display</small>	Factory Setting	Refer to
ComSTATE	Communications Option State	DISABL MOD3K MODBUS RS422	DISABL	Section 4.14
Com ADDR	Communications Station Address	1 to 99	0	
ComADDR2	Loop 2 Communications Station Address	1 to 99 When ComSTATE = MODBUS, ComADDR2 = Com ADDR	0	
SHEDENAB	Shed Enable	DISABL ENABL	DISABL	
SHEDTIME	Shed Time	0 to 255 sample periods (1 sample period = 0.333 seconds) 0 = No Shed	0	
PARITY	Parity	ODD EVEN Fixed at NONE when ComSTATE = MODBUS	ODD	
BAUD	Baud Rate	2400 4800 9600 19200	2400	
DUPLEX	Duplex Operation	HALF FULL ATTENTION <ul style="list-style-type: none"> • When ComSTATE = MODBUS, this selection is fixed at HALF. • When the RS422/485/Auxiliary output option board is installed, this selection is fixed at HALF. 	HALF	

Function Prompt Lower Display	Function Name	Selections or Range of Setting Upper Display	Factory Setting	Refer to
WS_FLOAT	Word swap order	FP_B Floating point big endian FP_BB Floating point big endian with byte-swapped FP_L Floating point little endian FP_LB Floating point little endian with byte-swapped		
TX DELAY	Transmission Delay	1 to 500 milliseconds	1	
SHEDMODE	Shed Controller Mode and Output Level	LAST ToAUTO FSAFE TO MAN	LAST	
SHEDSP	Shed Setpoint Recall	TO LSP TO CSP	TO LSP	
UNITS	Communication Units	PERCNT ENG	PERCNT	
CSP RATO	Loop 1 Computer Setpoint Ratio	-20.0 to 20.0	1.0	
CSP BIAS	Loop 1 Computer Setpoint Bias	-999. to 9999. (in engineering units)	0	
CSP2RATO*	Loop 2 or Cascade Computer Setpoint Ratio	-20.0 to 20.0	1.0	
CSP2BIAS*	Loop 2 or Cascade Computer Setpoint Bias	-999. to 9999. (in engineering units)	0	
LOOPBACK	Local Loop Back	DISABL ENABLE	DISABL	
*Not available on DC330B				

3.19 Alarms Set Up Group

Introduction

This data deals with the Alarms function that is available with your controller.

There are two alarms available. Each alarm has two setpoints. You can configure each of these two setpoints to alarm on one of several events and you can configure each setpoint to alarm high or low. You can also configure the two setpoints to alarm on the same event and to alarm both high and low, if desired.

Function prompts

Table 3-16 lists all the function prompts in the Alarms Set Up group.

Table 3-16 Alarms Group Function Prompts

Function Prompt <small>Lower Display</small>	Function Name	Selections or Range of Setting <small>Upper Display</small>	Factory Setting	Refer to
A1S1 VAL	Alarm 1 Setpoint 1 Value	Value in engineering units	90	Section 4.15
A1S2 VAL	Alarm 1 Setpoint 2 Value	Value in engineering units	10	
A2S1 VAL	Alarm 2 Setpoint 1 Value	Value in engineering units	95	
A2S2 VAL	Alarm 2 Setpoint 2 Value	Value in engineering units	5	

Function Prompt Lower Display	Function Name	Selections or Range of Setting Upper Display	Factory Setting	Refer to
A1S1TYPE	Alarm 1 Setpoint 1 Type	NONE INP 1 INP 2 INP 3 PV (Loop 1 Process Variable) DEV (Loop 1 Deviation) OUTPUT (Loop 1 Output) SHED (Both Loops) EV ON (Event On – SP Program) EV OFF (Event Off – SP Program) MANUAL (Loop 1) REM SP (Loop 1 Remote Setpoint) F SAFE (Loop 1 Failsafe) PVRATE (Loop 1 PV Rate of Change) <i>Expanded models:</i> PV 2 (Loop 2 Process Variable) DEV 2 (Loop 2 Deviation) OUT 2 (Loop 2 Output) MAN 2 (Loop 2 Manual) RSP 2 (Loop 2 Remote Setpoint) F SAF2 (Loop 2 Failsafe) PVRAT2 (Loop 2 PV Rate of Change) BREAK BREAK2 TOTAL <i>HealthWatch:**</i> TIMER1 (HealthWatch Maintenance Timer 1) TIMER2 (HealthWatch Maintenance Timer 2) TIMER3 (HealthWatch Maintenance Timer 3) COUNT1 (HealthWatch Maintenance Counter 1) COUNT2 (HealthWatch Maintenance Counter 2) COUNT3 (HealthWatch Maintenance Counter 3)	NONE	Section 4.15
A1S2TYPE	Alarm 1 Setpoint 2 Type	Same as A1S1TYPE	NONE	
A2S1TYPE	Alarm 2 Setpoint 1 Type	Same as A1S1TYPE	NONE	
A2S2TYPE	Alarm 2 Setpoint 2 Type	Same as A1S1TYPE	NONE	
A1S1 H L	Alarm 1, Setpoint 1 State	LOW HIGH	HIGH	
A1S1 EV	SP Programming Event Alarm State for Alarm 1, Setpoint 1	BEGIN END	--	
A1S2 H L	Alarm 1, Setpoint 2 State	LOW HIGH	LOW	
A1S2 EV	SP Programming Event Alarm State for Alarm 1, Setpoint 2	BEGIN END	--	

Function Prompt Lower Display	Function Name	Selections or Range of Setting Upper Display	Factory Setting	Refer to
A2S1 H L	Alarm 2, Setpoint 1 State	LOW HIGH	HIGH	Section 4.15
A2S1 EV	SP Programming Event Alarm State for Alarm 2, Setpoint 1	BEGIN END	--	
A2S2 H L	Alarm 2, Setpoint 2 State	LOW HIGH	LOW	
A2S2 EV	SP Programming Event Alarm State for Alarm 2, Setpoint 2	BEGIN END	--	
AL HYST	Alarm Hysteresis	0.0 to 100.0 % of output or span, as appropriate	0.1	
ALM OUT1*	Latching Alarm for Output 1	NO LAT LATCH	NO LAT	
BLOCK	Alarm Blocking	DISABL BLOCK1 BLOCK2 BLK 12	DISABL	

*For CE conformity, Performance Criterion A, select NO LAT.

3.20 Display Parameters Set Up Group

Introduction This data deals with the Decimal Place, Units of Temperature, Power Frequency, and Process ID Tag.

Function prompts Table 3-17 lists all the function prompts in the Display Set Up group.

Table 3-17 Display Group Function Prompts

Function Prompt Lower Display	Function Name	Selections or Range of Setting Upper Display	Factory Setting	Refer to
DECIMAL	Control Loop 1 Decimal Place	XXXX XXX.X XX.XX X.XXX ATTENTION Auto-ranging will occur to whichever decimal place has been selected.	XXXX	Section 4.16
DECIMAL2	Control Loop 2 Decimal Place	XXXX XXX.X XX.XX X.XXX	XXXX	
TEMPUNIT	Control Loop 1 Temperature Units	DEG F DEG C NONE	NONE	
PWR FREQ	Power Frequency	60 HZ 50 HZ	60 HZ	
RATIO 2	Ratio for Input 2—Set from the front of the controller	DISABL ENABLE	DISABL	
LANGUAGE	Display Language	ENGLIS FRENCH GERMAN SPANIS ITALAN	ENGLIS	

3.21 Calibration Group

Calibration data The prompts used here are for field calibration purposes. Refer to *Section 7 – Calibration* in this manual for complete information and instructions.

3.22 Maintenance Set Up Group

Introduction

The Maintenance group prompts are part of the HealthWatch feature (available only on DC330E model). These prompts let you count and time the activity of discrete events such as relays, alarms, control modes and others, to keep track of maintenance needs.

Function prompts

Table 3-18 lists all the function prompts in the Maintenance Set Up group.

Table 3-18 Maintenance Group Function Prompts

Function Prompt Lower Display	Function Name	Selections or Range of Setting Upper Display	Factory Setting	Refer to
TIME1	TIMER 1	DISABL LASTR AL1SP1 AL1SP2 AL2SP1 AL2SP2 MANUAL GSOAK SOOTNG DIGIN1 DIGIN2 MAN2	DISABL	Section 4.18
HRS.MIN1 OR DAYS.HRS1	ELAPSED TIME 1	Read only		
TIME2	TIMER 2	Same as TIME1	DISABL	
HRS.MIN2 OR DAYS.HRS2	ELAPSED TIME 2	Read only		
TIME3	TIMER 3	Same as TIME1	DISABL	
HRS.MIN3 OR DAYS.HRS3	ELAPSED TIME 3	Read only		

Function Prompt Lower Display	Function Name	Selections or Range of Setting Upper Display	Factory Setting	Refer to
COUNTER1	COUNTER 1	DISABL MANUAL AL1SP1 AL1SP2 AL2SP1 AL2SP2 DIGIN1 DIGIN2 OUT1*1K OUT2*1K GSOAK PWRCYC PV_RNG FAILSF TUNE MAN2 PVRNG2 FSF2 TUNE2	DISABL	Section 4.18
COUNTS1	NUMBER OF COUNTS 1	Read only		
COUNTER2	COUNTER 2	Same as COUNTER1	DISABL	
COUNTS2	NUMBER OF COUNTS 2	Read only		
COUNTER3	COUNTER 3	Same as COUNTER1	DISABL	
COUNTS3	NUMBER OF COUNTS 3	Read only		
PASSWORD	PASSWORD	0-9999	0	
RES TYPE	RESET TYPE	NONE TIMER1 TIMER2 TIMER3 ALL TM COUNT1 COUNT2 COUNT3 ALL CO ALL TC	NONE	

3.23 Status Group

Status test data

The prompts used here are read only. They are used to determine the reason for a controller failure. Refer to *Section 9 – Troubleshooting* in this manual for complete information.

3.24 Configuration Record Sheet

Basic Model: DC330B-XX-XXX

DMCS Model: DC330D-XX-XXX

Keep a record

Enter the value or selection for each prompt on this sheet so you will have a record of how your controller was configured.

Group Prompt	Function Prompt	Value or Selection	Factory Setting	Group Prompt	Function Prompt	Value or Selection	Factory Setting	
TUNING	PROP BD	_____	--	ALGORITHM	CONT ALG	_____	PID A	
	or				TIMER	_____	DISABL	
	GAIN	_____	1.000		PERIOD	_____	0.01	
	or				START	_____	KEY	
	GAINVALn	Read Only	--		L DISP	_____	TI REM	
	RATE MIN	_____	0.00		INP ALG1	_____	NONE	
	RSET MIN	_____	1.00		MATH K	_____	--	
	or				CALC HI	_____	--	
	RSET RPM	_____	--		CALC LO	_____	--	
	MAN RSET	_____	0		ALG1 INA	_____	--	
	PROPB2	_____	--		ALG1 INB	_____	--	
	or				ALG1 INC	_____	--	
	GAIN 2	_____	1.000		ALG1BIAS	_____	--	
	RATE2MIN	_____	0.00		PCT CO	_____	0.200	
	RSET2MIN	_____	1.00					
	or				OUT ALG	OUT ALG	_____	CURRNT
	RSET2RPM	_____	--		4-20 RNG	_____	100PCT	
	CYC SEC	_____	20		RLYSTATE	_____	1OF2ON	
	or				RLY TYPE	_____	MECHAN	
	CYC SX3	_____	20					
CYC2 SEC	_____	20	INPUT 1	IN1 TYPE	_____	0-10mV		
or			XMITTER1	_____	LINEAR			
CYC2 SX3	_____	20	IN1 HI	_____	1000			
SECURITY	_____	0	IN1 LO	_____	0			
LOCKOUT	_____	CALIB	RATIO 1	_____	1.00			
AUTO MAN	_____	ENABLE	BIAS IN1	_____	0			
SP SEL	_____	ENABLE	FILTER 1	_____	0			
RUN HOLD	_____	ENABLE	BURNOUT1	_____	NONE			
			EMMISIV1	_____	0.00			
SP RAMP	SP RAMP	_____	DISABL					
	TIME MIN	_____	3	INPUT 2	IN2 TYPE	_____	0-10mV	
	FINAL SP	_____	1000	XMITTER2	_____	LINEAR		
	PVHOTSTART	_____	DISABL	IN2 HI	_____	1000		
	SP RATE	_____	DISABL	IN2 LO	_____	0		
	EU/HR UP	_____	0	RATIO 2	_____	1.00		
	EU/HR DN	_____	0	BIAS IN2	_____	0		
	SP PROG	_____	DISABL	FILTER 2	_____	0		
				BURNOUT2	_____	NONE		
				EMMISIV2	_____	0.00		
ACCUTUNE	FUZZY	_____	DISABL					
	ACCUTUNE	Read Only	DISABL					
	AT ERROR	_____	NONE					

Group Prompt	Function Prompt	Value or Selection	Factory Setting	Group Prompt	Function Prompt	Value or Selection	Factory Setting	
CONTROL	PV SOURC	_____	INP 1	COM	ComSTATE	_____	DISABL	
	PID SETS	_____	1 ONLY		Com ADDR	_____	0	
	SW VALUE	_____	0.00		SHEDENAB	_____	DISABL	
	LSP'S	_____	1 ONLY		SHEDTIME	_____	0	
	RSP SRC	_____	NONE		PARITY	_____	ODD	
	AUTOBIAS	_____	DISABL		BAUD	_____	2400	
	SP TRACK	_____	NONE		DUPLEX	_____	HALF	
	PWR MODE	_____	MANUAL		WSFLOAT	_____	FP B	
	PWR OUT	_____	LAST		TX DELAY	_____	1	
	SP HiLIM	_____	1000		SHEDMODE	_____	LAST	
	SP LoLIM	_____	0		SHEDSP	_____	TO LSP	
	ACTION	_____	REVRSE		UNITS	_____	PERCNT	
	OUT RATE	_____	DISABL		CSP RATO	_____	1.0	
	PCT/M UP	_____	0		CSP BIAS	_____	0	
	PCT/M DN	_____	0		LOOPBACK	_____	DISABL	
	OUTHILIM	_____	100		ALARMS	A1S1 VAL	_____	90
	OUTLoLIM	_____	0.0			A1S2 VAL	_____	10
	I Hi LIM	_____	100.0			A2S1 VAL	_____	95
	I Lo LIM	_____	0.0			A2S2 VAL	_____	5
	DROPOFF	_____	0			A1S1TYPE	_____	NONE
	DEADBAND	_____	1.0			A1S2TYPE	_____	NONE
	OUT HYST	_____	0.5			A2S1TYPE	_____	NONE
	FAILMODE	_____	NO LAT			A2S2TYPE	_____	NONE
	FAILSAFE	_____	0.0			A1S1 H L	_____	HIGH
	MAN OUT	_____	--			A1S1 EV	_____	--
AUTO OUT	_____	--	A1S2 H L	_____		LOW		
PBorGAIN	_____	GAIN	A1S2 EV	_____		--		
MINorRPM	_____	MIN	A2S1 H L	_____		HIGH		
OPTIONS	AUX OUT	_____	DISABL	A2S1 EV		_____	--	
	4mA VAL	_____	0.0	A2S2 H L		_____	LOW	
	20mA VAL	_____	0	A2S2 EV		_____	--	
	DIG IN 1	_____	NONE	AL HYST		_____	0.1	
	DIG1 COM	_____	DISABL	ALM OUT1		_____	NO LAT	
	DIG IN 2	_____	NONE	BLOCK		_____	DISABL	
	DIG2 COM	_____	DISABL	DISPLAY		DECIMAL	_____	XXXX
						TEMPUNIT	_____	NONE
			PWR FREQ			_____	60 HZ	
			RATIO 2			_____	DISABL	
			LANGUAGE			_____	ENGLIS	

3.25 Configuration Record Sheet

Expanded Model: DC330E-XX-XXX

Keep a record

Enter the value or selection for each prompt on this sheet so you will have a record of how your controller was configured.

Group Prompt	Function Prompt	Value or Selection	Factory Setting	Group Prompt	Function Prompt	Value or Selection	Factory Setting
TUNING	PROP BD	_____	--	TUNING2	PROPBD3	_____	--
	or GAIN	_____	1.000		or GAIN 3	_____	1.000
	or GAINVALn	Read Only	--		or GAINVALn	Read Only	--
	RATE MIN	_____	0.00		RATE3MIN	_____	0.00
	RSET MIN	_____	1.00		RSET3MIN	_____	1.00
	or RSET RPM	_____	--		or RSET3RPM	_____	--
	MAN RSET	_____	0		MANRSET3	_____	0
	PROPBD2	_____	--		PROPBD4	_____	--
	or GAIN 2	_____	1.000		or GAIN 4	_____	1.000
	RATE2MIN	_____	0.00		RATE4MIN	_____	0.00
	RSET2MIN	_____	1.00		RSET4MIN	_____	1.0
	or RSET2RPM	_____	--		or RSET4RPM	_____	--
	CYC SEC	_____	20		CYC3 SEC	_____	20
	or CYC SX3	_____	20		or CYC3 SX3	_____	20
	CYC2 SEC	_____	20		CYC4 SEC	_____	20
	or CYC2 SX3	_____	20		or CYC4 SX3	_____	20
	SECURITY	_____	0		PVEUVAL1	_____	0
	LOCKOUT	_____	CALIB		PVEUVAL2	_____	0
	AUTO MAN	_____	ENABLE		PVEUVAL3	_____	0
	SP SEL	_____	ENABLE		PVEUVAL4	_____	0
	RUN HOLD	_____	ENABLE		PVEUVAL5	_____	0
	PVEUVAL1	_____	0		PVEUVAL6	_____	0
	PVEUVAL2	_____	0		PVEUVAL7	_____	0
	PVEUVAL3	_____	0		PVEUVAL8	_____	0
	PVEUVAL4	_____	0		GAINVAL1	_____	1.000
	PVEUVAL5	_____	0		GAINVAL2	_____	1.000
	PVEUVAL6	_____	0		GAINVAL3	_____	1.000
	PVEUVAL7	_____	0		GAINVAL4	_____	1.000
	PVEUVAL8	_____	0		GAINVAL5	_____	1.000
	GAINVAL1	_____	1.000		GAINVAL6	_____	1.000
	GAINVAL2	_____	1.000		GAINVAL7	_____	1.000
	GAINVAL3	_____	1.000		GAINVAL8	_____	1.000
GAINVAL4	_____	1.000	SP RAMP	SP RAMP	_____	DISABL	
GAINVAL5	_____	1.000		TIME MIN	_____	3	
GAINVAL6	_____	1.000		FINAL SP	_____	1000	
GAINVAL7	_____	1.000		PV-HOTSTART	_____	DISABL	
GAINVAL8	_____	1.000		SP RATE	_____	DISABL	
				EU/HR UP	_____	0	
				EU/HR DN	_____	0	
				EU/HRUP2	_____	0	
			EU/HRDN2	_____	0		
			SP PROG	_____	DISABL		

Group Prompt	Function Prompt	Value or Selection	Factory Setting	Group Prompt	Function Prompt	Value or Selection	Factory Setting		
CONTROL	PV SOURC	_____	INP 1	COM	ComSTATE	_____	DISABL		
	PID SETS	_____	1 ONLY		Com ADDR	_____	0		
	SW VALUE	_____	0.00		ComADDR2	_____	0		
	LSP'S	_____	1 ONLY		SHEDTIME	_____	0		
	RSP SRC	_____	NONE		PARITY	_____	ODD		
	AUTOBIAS	_____	DISABL		BAUD	_____	2400		
	SP TRACK	_____	NONE		DUPLEX	_____	HALF		
	PWR MODE	_____	MANUAL		TX DELAY	_____	1		
	PWR OUT	_____	LAST		SHEDMODE	_____	LAST		
	SP HiLIM	_____	1000		SHEDSP	_____	TO LSP		
	SP LoLIM	_____	0		UNITS	_____	PERCNT		
	ACTION	_____	REVRSE		CSP RATO	_____	1.0		
	OUT RATE	_____	DISABL		CSP BIAS	_____	0		
	PCT/M UP	_____	0		CSP2RATO	_____	1.0		
	PCT/M DN	_____	0		CSP2BIAS	_____	0		
	OUTHILIM	_____	100		LOOPBACK	_____	DISABL		
	OUTLoLIM	_____	0.0		ALARMS	A1S1 VAL	_____	90	
	I Hi LIM	_____	100.0			A1S2 VAL	_____	10	
	I Lo LIM	_____	0.0			A2S1 VAL	_____	95	
	DROPOFF	_____	0			A2S2 VAL	_____	5	
	DEADBAND	_____	1.0			A1S1TYPE	_____	NONE	
	OUT HYST	_____	0.5			A1S2TYPE	_____	NONE	
	FAILMODE	_____	NO LAT			A2S1TYPE	_____	NONE	
	FAILSAFE	_____	0.0			A2S2TYPE	_____	NONE	
	MAN OUT	_____	--			A1S1 H L	_____	HIGH	
	AUTO OUT	_____	--			A1S1 EV	_____	--	
	PBorGAIN	_____	GAIN			A1S2 H L	_____	LOW	
	MINorRPM	_____	MIN			A1S2 EV	_____	--	
	CONTROL2	PV2 SRC	_____			INP 2	A2S1 H L	_____	HIGH
		FORCE MA	_____			DISABL	A2S1 EV	_____	--
		PID SETS	_____			1 ONLY	A2S2 H L	_____	LOW
SW VALUE		_____	0.00	A2S2 EV		_____	--		
LSP'S		_____	1 ONLY	AL HYST		_____	0.1		
RSP SRC		_____	NONE	ALM OUT1		_____	NO LAT		
AUTOBIAS		_____	DISABL	BLOCK		_____	DISABL		
SPTRACK		_____	NONE	DISPLAY		DECIMAL	_____	XXXX	
SP HiLIM		_____	1000			DECIMAL2	_____	XXXX	
SP LoLIM		_____	0		TEMPUNIT	_____	NONE		
ACTION		_____	REVRSE		PWR FREQ	_____	60 HZ		
OUT RATE		_____	DISABL		RATIO 2	_____	DISABL		
PCT/M UP		_____	0	LANGUAGE	_____	ENGLIS			
PCT/M DN		_____	0	MAINTNCE	TIME1	_____	DISABL		
OUTHILIM		_____	100		TIME2	_____	DISABL		
OUTLoLIM		_____	0		TIME3	_____	DISABL		
I Hi LIM		_____	100.0		COUNTER1	_____	DISABL		
I Lo LIM		_____	0.0		COUNTER2	_____	DISABL		
DROPOFF		_____	0		COUNTER3	_____	DISABL		
DEADBAND		_____	1.0		PASSWORD	_____	0		
FAILMODE		_____	NO LAT		RES TYPE	_____	NONE		
FAILSAFE	_____	0	OPTIONS	AUX OUT	_____	DISABL			
OPTIONS	or				CUR OUT2	_____	DISABL		
	4mA VAL	_____		0.0	4mA VAL	_____	0.0		
	20mA VAL	_____		0	20mA VAL	_____	0		
	DIG IN 1	_____		NONE	DIG IN 1	_____	NONE		
	DIG1 COM	_____		DISABL	DIG1 COM	_____	DISABL		
	DIG IN 2	_____		NONE	DIG IN 2	_____	NONE		
	DIG2 COM	_____	DISABL	DIG2 COM	_____	DISABL			

Section 4 – Configuration Prompt Definitions

4.1 Overview

Introduction

This section provides information for all the user configurable parameters listed in *Section 3 - Configuration*. If you are not familiar with these parameters, this section gives you the parameter prompt, the selection or range of setting that you can make, and a definition of how each parameter setting affects controller performance. It will also refer you to any other prompts that might be affected by your selection.

What's in this section?

The table below lists the topics that are covered in this section. They are listed in the order of their appearance in the controller.

	Topic	See Page
4.1	Overview	79
4.2	Loop 1 Tuning Parameters Set Up Group	80
4.3	Loop 2 Tuning Parameters Set Up Group	84
4.4	Setpoint Ramp/Rate/Programming Set Up Group	85
4.5	Accutune Set Up Group	88
4.6	Algorithm Data Set Up Group	92
4.7	Output Algorithm Set Up Group	109
4.8	Input 1 Set Up Group	112
4.9	Input 2 Set Up Group	116
4.10	Input 3 Set Up Group	117
4.11	Loop 1 Control Set Up Group	118
4.12	Loop 2 Control Set Up Group	124
4.13	Options Set Up Group	129
4.14	Communications Set Up Group	135
4.15	Alarms Set Up Group	139
4.16	Display Parameters Set Up Group	143
4.17	Calibration Data	144
4.18	Maintenance Set Up Group	144
4.19	Status Test Data	146

4.2 Loop 1 Tuning Parameters Set Up Group

Introduction

Tuning consists of establishing the appropriate values for the tuning constants for a single loop controller. These parameters are also for Loop 1 of a 2-Loop or Cascade control configuration.

The Accutune feature automatically selects Gain, Rate, and Reset.

This section also contains Keyboard Lockout/Security selections.

Set this group last

Because this group contains functions that have to do with security and lockout, we recommend that you configure this group last, after all the other configuration data has been loaded.

Tuning group prompts

Table 4-1 lists all the function prompts in the Tuning Set Up group and their definitions.

Table 4-1 Tuning Group Prompt Definitions

Lower Display Prompt	Upper Display Range of Setting or Selection	Parameter Definition
PROP BD or GAIN	0.1 to 9999 % or 0.001 to 1000	<p>PROPORTIONAL BAND (simplex) is the percent of the range of the measured variable for which a proportional controller will produce a 100 % change in its output.</p> <p>GAIN is the ratio of output change (%) over the measured variable change (%) that caused it.</p> $G = \frac{100\%}{PB\%}$ <p>where PB is the proportional band (in %)</p> <p>If the PB is 20 %, then the Gain is 5. And, at those settings, a 3 % change in the error signal (SP-PV) will result in a 15 % change in the controller's output due to proportional action. If the Gain is 2, then the PB is 50 %.</p> <p>Also defined as "HEAT" Gain on Duplex models for variations of Heat/Cool applications.</p> <p><i>The selection of Proportional Band or Gain is made in the CONTROL parameter group under prompt PBorGAIN.</i></p>
or GAINVALn	Read Only	LOOP 1 GAIN —This is the value being provided by Gain Scheduling when enabled.
RATE MIN	0.00 to 10.00 minutes 0.08 or less = OFF	<p>RATE action, in minutes, affects the controller's output whenever the deviation is changing; and affects it more when the deviation is changing faster.</p> <p>Also defined as "HEAT" Rate on Duplex models for variations of Heat/Cool applications.</p>

Lower Display Prompt	Upper Display Range of Setting or Selection	Parameter Definition
<p>RSET MIN or RSET RPM</p>	<p>0.02 to 50.00</p>	<p>RSET MIN = Reset in Minutes per Repeat RSET RPM = Reset in Repeats per Minute</p> <p>RESET (Integral Time) adjusts the controller's output in accordance with both the size of the deviation (SP–PV) and the time it lasts. The amount of the corrective action depends on the value of Gain. The Reset adjustment is measured as how many times proportional action is repeated per minute or how many minutes before one repeat of the proportional action occurs.</p> <p>Used with control algorithm PID-A or PID-B. Also defined as "HEAT" Reset on Duplex models for variations of Heat/Cool applications.</p> <p><i>The selection of minutes per repeat or repeats per minute is made in the CONTROL parameters group under prompt MINorRPM.</i></p>
<p>MAN RSET</p>	<p>–100 to +100 (in % output)</p>	<p>MANUAL RESET is only applicable if you use control algorithm PD WITH MANUAL RESET in the Algorithm Set Up group. Because a proportional controller will not necessarily line out at setpoint, there will be a deviation (offset) from setpoint. This eliminates the offset and lets the PV line out at setpoint.</p> <p>Bias appears on the lower display.</p>
<p>PROPBD2 or GAIN 2</p>	<p>0.1 to 9999 % or 0.001 to 1000</p>	<p>PROPORTIONAL BAND 2 or GAIN 2, RATE 2, and RESET 2 parameters are the same as previously described for "Heat" except that they refer to the cool zone tuning constants on duplex models or the second set of PID constants, whichever is pertinent.</p>
<p>RATE2MIN</p>	<p>0.00 to 10.00 minutes 0.08 or less = OFF</p>	<p>ATTENTION</p>
<p>RSET2MIN RSET2RPM</p>	<p>0.02 to 50.00</p>	<p>Set 2 Tuning Parameters are not available when the Accutune selection for Loop 1 is SP+PV.</p>
<p>CYC SEC or CYC SX3</p>	<p>1 to 120</p> <p>ATTENTION If 1/3 second increments are used, value of 120 = .33 seconds x 120 = 40 seconds maximum.</p>	<p>CYCLE TIME (HEAT) determines the length of one time proportional output relay cycle. Defined as "HEAT" cycle time for Heat/Cool applications.</p> <p>CYC SEC—Electromechanical relays CYC SX3—Solid state relays</p> <p><i>Cycle times are in either second or 1/3-second increments depending upon the configuration of RLY TYPE in the Output Algorithm Set Up group.</i></p>
<p>CYC2 SEC or CYC2 SX3</p>	<p>1 to 120</p> <p>ATTENTION If 1/3 second increments are used, value of 120 = .33 seconds x 120 = 40 seconds maximum.</p>	<p>CYCLE TIME 2 (COOL) is the same as above except it applies to Duplex models as the cycle time in the "COOL" zone of Heat/Cool applications or for the second set of PID constants.</p> <p>CYC2 SEC—Electromechanical relays CYC2 SX3—Solid state relays</p> <p><i>Cycle times are in either second or 1/3-second increments depending upon the configuration of RLY TYPE in the Output Algorithm Set Up group.</i></p>

Lower Display Prompt	Upper Display Range of Setting or Selection	Parameter Definition
SECURITY	0 to 4095	<p>SECURITY CODE—The level of keyboard lockout may be changed in the Set Up mode. Knowledge of a security code may be required to change from one level to another. Select this number here, copy it, and keep it in a secure location.</p> <p>NOTE: The Security Code is for keyboard entry only and is not available via communications.</p> <p><i>Can only be changed if LOCKOUT selection is NONE.</i></p>
LOCKOUT	<p>NONE</p> <p>CALIB</p> <p>+ CONF</p> <p>+ VIEW</p> <p>MAX</p>	<p>LOCKOUT applies to one of the functional groups: Configuration, Calibration, Tuning, Accutune. DO NOT CONFIGURE UNTIL ALL CONFIGURATION IS COMPLETE.</p> <p>NONE—No lockout; all groups are read/write.</p> <p>CALIB—All groups are available for read/write except for the Calibration and Keyboard Lockout groups.</p> <p>+ CONF—Tuning, SP Ramp, and Accutune groups are read/write. All other groups are read only. Calibration and Keyboard Lockout groups are not available.</p> <p>+VIEW—Tuning and Setpoint Ramp parameters are read/write. No other parameters are viewable.</p> <p>MAX—Tuning and Setpoint Ramp parameters are available for read only. No other parameters are viewable.</p>
AUTO MAN	<p>DISABL</p> <p>ENABLE</p>	<p>MANUAL/AUTO KEY LOCKOUT—Allows you to disable the Manual/Auto key.</p> <p>Disable</p> <p>Enable</p> <p><i>Can only be viewed if LOCKOUT is configured for NONE.</i></p>
SP SEL	<p>DISABL</p> <p>ENABLE</p>	<p>SETPOINT SELECT KEY LOCKOUT—Allows you to disable the Setpoint Select key.</p> <p>Disable</p> <p>Enable</p> <p><i>Can only be viewed if LOCKOUT is configured for NONE.</i></p>
RUN HOLD	<p>DISABL</p> <p>ENABLE</p>	<p>RUN/HOLD KEY LOCKOUT—Allows you to disable the Run/Hold key, for either SP Ramp or SP Program. <i>The Run/Hold key is never disabled when used to acknowledge a latched alarm 1.</i></p> <p>Disable</p> <p>Enable</p> <p><i>Can only be viewed if LOCKOUT is configured for NONE.</i></p>

Lower Display Prompt	Upper Display Range of Setting or Selection	Parameter Definition																		
<p>PVEUVAL1</p> <p>PVEUVAL2</p> <p>PVEUVAL3</p> <p>PVEUVAL4</p> <p>PVEUVAL5</p> <p>PVEUVAL6</p> <p>PVEUVAL7</p> <p>PVEUVAL8</p>	<p>PV1 Value for Gain Scheduling</p> <p>PV2 Value for Gain Scheduling</p> <p>PV3 Value for Gain Scheduling</p> <p>PV4 Value for Gain Scheduling</p> <p>PV5 Value for Gain Scheduling</p> <p>PV6 Value for Gain Scheduling</p> <p>PV7 Value for Gain Scheduling</p> <p>PV8 Value for Gain Scheduling</p>	<p>Gain Scheduling allows you to schedule eight user-defined Gain Values (GAINVALn) applied over eight user-defined PV bands (PVEUVALn).*</p> <p>PVEUVAL1 is the first PV value to be used in the schedule. Enter a value, in engineering units, that is within the PV limits.</p> <p>To complete the PV selections for the segments, enter a PV value for all the PVEUVAL prompts listed.</p> <p>The table on the following page shows the relationship between the GAIN Values and the PVEU Values.</p> <p>Gain Scheduling prompts are only available when PID SETS in the Control Set Up group is configured for GAIN S.</p> <p>*Apply to Expanded Model DC330E-XX-X(C or E)X only (requires math option).</p>																		
<p>GAINVAL1</p> <p>GAINVAL2</p> <p>GAINVAL3</p> <p>GAINVAL4</p> <p>GAINVAL5</p> <p>GAINVAL6</p> <p>GAINVAL7</p> <p>GAINVAL8</p>	<p>Gain Value 1 for Gain Scheduling</p> <p>Gain Value 2 for Gain Scheduling</p> <p>Gain Value 3 for Gain Scheduling</p> <p>Gain Value 4 for Gain Scheduling</p> <p>Gain Value 5 for Gain Scheduling</p> <p>Gain Value 6 for Gain Scheduling</p> <p>Gain Value 7 for Gain Scheduling</p> <p>Gain Value 8 for Gain Scheduling</p>	<p>GAIN VAL 1 is the first of eight user-defined Gain values.</p> <p>Enter a Gain Value you want to be used with PVEUVAL n previously entered. Gain values are between 0.001 and 1000 floating.</p> <p>To complete the Gain selections, enter a Gain value for all the GAINVAL prompts listed.</p> <p>The table below shows the relationship between the GAIN Values and the PVEU Values.</p> <table border="1" data-bbox="852 1184 1438 1533"> <thead> <tr> <th>Gain Value X</th> <th>PV band over which each Gain applies</th> </tr> </thead> <tbody> <tr> <td>1</td> <td>Low range limit to PVEUVAL2</td> </tr> <tr> <td>2</td> <td>PVUEVAL2 to PVEUVAL3</td> </tr> <tr> <td>3</td> <td>PVUEVAL3 to PVEUVAL4</td> </tr> <tr> <td>4</td> <td>PVUEVAL4 to PVEUVAL5</td> </tr> <tr> <td>5</td> <td>PVUEVAL5 to PVEUVAL6</td> </tr> <tr> <td>6</td> <td>PVUEVAL6 to PVEUVAL7</td> </tr> <tr> <td>7</td> <td>PVUEVAL7 to PVEUVAL8</td> </tr> <tr> <td>8</td> <td>PVUEVAL8 to High Range Limit</td> </tr> </tbody> </table> <p>ATTENTION When PB is configured (instead of Gain) in the Control group prompt PBoR GAIN, the displayed GAINVALn is in units of %PB. The lower display will still show Gain.</p> <p>Gain Scheduling prompts are only available when PID SETS in the Control Set Up group is configured for GAIN S.</p>	Gain Value X	PV band over which each Gain applies	1	Low range limit to PVEUVAL2	2	PVUEVAL2 to PVEUVAL3	3	PVUEVAL3 to PVEUVAL4	4	PVUEVAL4 to PVEUVAL5	5	PVUEVAL5 to PVEUVAL6	6	PVUEVAL6 to PVEUVAL7	7	PVUEVAL7 to PVEUVAL8	8	PVUEVAL8 to High Range Limit
Gain Value X	PV band over which each Gain applies																			
1	Low range limit to PVEUVAL2																			
2	PVUEVAL2 to PVEUVAL3																			
3	PVUEVAL3 to PVEUVAL4																			
4	PVUEVAL4 to PVEUVAL5																			
5	PVUEVAL5 to PVEUVAL6																			
6	PVUEVAL6 to PVEUVAL7																			
7	PVUEVAL7 to PVEUVAL8																			
8	PVUEVAL8 to High Range Limit																			

4.3 Loop 2 Tuning Parameters Set Up Group

Introduction Tuning 2 (Loop 2) consists of establishing the appropriate values for the tuning constants for Loop 2 on 2-Loop or Internal Cascade control.

Loop 2 is only available on Expanded Model DC330E.

Tuning 2 group prompts Table 4-2 lists all the function prompts in the Tuning 2 Set Up group and their definitions.

Table 4-2 Loop 2 Tuning Group Prompt

Lower Display Prompt	Upper Display Range of Setting or Selection	Parameter Definition												
PROPBD3 or GAIN 3 or GAINVALn RATE3MIN RSET3MIN or RSET3RPM MANRSET3 PROPBD4 or GAIN 4 RATE4MIN RSET4MIN or RSET4RPM CYC3 SEC or CYC3 SX3 CYC4 SEC or CYC4 SX3 PVEUVAL1 PVEUVAL2 PVEUVAL3 PVEUVAL4 PVEUVAL5 PVEUVAL6 PVEUVAL7 PVEUVAL8 GAINVAL1 GAINVAL2 GAINVAL3 GAINVAL4 GAINVAL5 GAINVAL6 GAINVAL7 GAINVAL8	Same as TUNING	<p>The definitions listed for the parameters at the left are the same as those listed previously for the Tuning Set Up group parameters except they are for Loop 2.</p> <p>The table below shows you how to use them for Duplex Heat/Cool applications.</p> <p>DUPLEX OUTPUT RANGES 0 to 50 %—TUNING SETS 2 AND 4: COOL 50 to 100 %—TUNING SETS 1 AND 3: HEAT</p> <table border="1"> <thead> <tr> <th>Duplex Output Range</th> <th>Heat or Cool</th> <th>Loop 1</th> <th>Loop 2</th> </tr> </thead> <tbody> <tr> <td>0 to 50 %</td> <td>Cool</td> <td><u>PID SET 2</u> Gain 2 Rate 2 Reset 2 Cycle 2</td> <td><u>PID SET 4</u> Gain 4 Rate 4 Reset 4 Cycle 4</td> </tr> <tr> <td>50 to 100 %</td> <td>Heat</td> <td><u>PID SET 1</u> Gain Rate Reset Cycle</td> <td><u>PID SET 3</u> Gain 3 Rate 3 Reset 3 Cycle 3</td> </tr> </tbody> </table> <p><i>Set 4 Tuning Parameters are not available when ACCUTUN2 is configured for SP+PV.</i></p> <p><i>Gain Scheduling prompts are only available when PID SETS in the Loop 2 Control Set Up group is configured for GAIN S.</i></p>	Duplex Output Range	Heat or Cool	Loop 1	Loop 2	0 to 50 %	Cool	<u>PID SET 2</u> Gain 2 Rate 2 Reset 2 Cycle 2	<u>PID SET 4</u> Gain 4 Rate 4 Reset 4 Cycle 4	50 to 100 %	Heat	<u>PID SET 1</u> Gain Rate Reset Cycle	<u>PID SET 3</u> Gain 3 Rate 3 Reset 3 Cycle 3
Duplex Output Range	Heat or Cool	Loop 1	Loop 2											
0 to 50 %	Cool	<u>PID SET 2</u> Gain 2 Rate 2 Reset 2 Cycle 2	<u>PID SET 4</u> Gain 4 Rate 4 Reset 4 Cycle 4											
50 to 100 %	Heat	<u>PID SET 1</u> Gain Rate Reset Cycle	<u>PID SET 3</u> Gain 3 Rate 3 Reset 3 Cycle 3											

4.4 Setpoint Ramp/Rate/Programming Set Up Group

Introduction

This data deals with enabling Single Setpoint Ramp function or Setpoint Rate on one or both control loops. You can start or stop the single SP Ramp by pressing the **RUN/HOLD** key.

A single setpoint ramp can be configured to occur between the current local setpoint and a final local setpoint over a time interval of from 1 to 255 minutes.

There is also a configurable rate of change for any local setpoint change.

ATTENTION SP RAMP and SP RATE will probably cause the SP portion of Accutune to abort. PV Tune will continue to function normally; however, during tuning (TUNE configuration) SP Ramp and Program are placed into HOLD until tuning completes.

SP Ramp/Rate/ Programming group prompts

Table 4-3 lists all the function prompts in the Setpoint Ramp/Rate Set Up group and their definitions.

Table 4-3 Setpoint Ramp/Rate Group Definitions

Lower Display Prompt	Upper Display Range of Setting or Selection	Parameter Definition
<p>SP RAMP*</p> <p>*SP Ramp parameters (TIME MIN and FINAL SP) appear when Ramp is enabled and SP Rate and SP Programming are disabled.</p>	<p>DISABL</p> <p>ENABLE</p> <p>ENABL2</p> <p>ENAB12</p>	<p>SINGLE SETPOINT RAMP—Make a selection to enable or disable the setpoint ramp function. Make sure you configure a ramp time and a final setpoint value.</p> <p><i>SP Rate and SP Programming must be disabled.</i></p> <p>DISABLE SETPOINT RAMP—Disables the setpoint ramp option.</p> <p>ENABLE SETPOINT RAMP—Allows the single setpoint ramp prompts for Loop 1 to be shown.</p> <p>ENABLE SETPOINT RAMP 2—Allows the single setpoint ramp to run in Loop 2.</p> <p>ENABLE SETPOINT RAMP 12—Allows the single setpoint ramp to be run on Loop 1 and Loop 2.</p>
<p>TIME MIN</p>	<p>0 to 255 minutes</p>	<p>SETPOINT RAMP TIME—Enter the number of minutes desired to reach the final setpoint. A ramp time of "0" implies an immediate change of setpoint.</p>

Lower Display Prompt	Upper Display Range of Setting or Selection	Parameter Definition
FINAL SP	Within setpoint limits	<p>SETPOINT RAMP FINAL SETPOINT—Enter the value desired for the final setpoint. The controller will operate at the setpoint set here when ramp is ended.</p> <p>ATTENTION If the ramp is on HOLD, the held setpoint can be changed by the ▲ and ▼ keys. However, the ramp time remaining and original ramp rate is not changed. Therefore, when returning to RUN mode, the setpoint will ramp at the same rate as previous to the local setpoint change and will stop if the final setpoint is reached before the time expires. If the time expires before the final setpoint is reached, it will jump to the final setpoint.</p> <p>ATTENTION SP RAMP and SP RATE will cause the SP portion of Accutune to abort. PV Tune will continue to function normally. Ramp is placed into HOLD while tuning (TUNE configuration).</p>
<p>SP RATE*</p> <p>*SP Rate parameters (EU/HR UP, EU/HR DN, EU/HRUP2, EU/HRDN2) appear when Rate is enabled and SP Ramp and SP Programming are disabled.</p>	<p>DISABL</p> <p>ENABLE</p> <p>ENABL2</p> <p>ENAB12</p>	<p>SETPOINT RATE—Lets you configure a specific rate of change for any local setpoint change.</p> <p><i>SP Ramp and SP Programming must be disabled.</i></p> <p>DISABLE SETPOINT RATE—Disables the setpoint rate option.</p> <p>ENABLE SETPOINT RATE—Allows the SP rate feature for Loop 1.</p> <p>ENABLE SETPOINT RATE 2—Allows the SP rate feature for Loop 2.</p> <p>ENABLE SETPOINT RATE 12—Allows the SP rate feature for Loop 1 and Loop 2.</p>
EU/HR UP	0 to 9999 in engineering units per hour	<p>RATE UP—Rate up value for Loop 1. When making a setpoint change, this is the rate at which the controller will change from the original setpoint up to the new one. The ramping (current) setpoint can be viewed as SPn in the lower display.</p> <p>Entering a 0 will imply an immediate change in Setpoint (i.e., no rate applies).</p>
EU/HR DN	0 to 9999 in engineering units per hour	<p>RATE DOWN—Rate down value for Loop 1. When making a setpoint change, this is the rate at which the controller will change from the original setpoint down to the new one. The ramping (current) setpoint can be viewed as SPn in the lower display.</p> <p>Entering a 0 will imply an immediate change in Setpoint (i.e., no rate applies).</p>
EU/HRUP2	0 to 9999 in engineering units per hour	<p>RATE UP—Rate up value for Loop 2. When making a setpoint change, this is the rate at which the controller will change from the original setpoint up to the new one. The ramping (current) setpoint can be viewed as SPn in the lower display.</p>

Lower Display Prompt	Upper Display Range of Setting or Selection	Parameter Definition
EU/HRDN2	0 to 9999 engineering units per hour	<p>RATE DOWN—Rate down value for Loop 2. When making a setpoint change, this is the rate at which the controller will change from the original setpoint down to the new one. The ramping (current) setpoint can be viewed as SPn in the lower display.</p> <p>Entering a 0 will imply an immediate change in Setpoint (i.e., no rate applies).</p>
SP PROG (option)	DISABL ENABLE ENABL2 ENAB12	<p>SETPOINT RAMP/SOAK PROGRAM—Available only with controllers that contain this option.</p> <p><i>SP RAMP and SP RATE must be disabled.</i></p> <p>DISABLE—Disables setpoint programming. ENABLE—Enables setpoint programming for Loop1 only. ENABL2—Enables setpoint programming for Loop 2 only. ENAB12—Enables setpoint programming for both Loop 1 and Loop 2.</p> <p>For reasons of convenience, the information for the prompts when SP PROG is enabled are included in <i>Section 6 – Setpoint Programming Option</i>.</p>

4.5 Accutune Set Up Group

Introduction

Accutune continuously adjusts the PID parameters in response to process variable disturbances and/or setpoint changes. Also, it can be used during start-up without prior initialization or process knowledge.

Accutune offers the following selections:

- **FUZZY**—Fuzzy Overshoot Suppression
- **TUNE**—Demand Tuning (operates with SP Ramp or SP Program), or
- **SP***—Setpoint Tuning, or
- **TUN+PV***—Demand Tuning plus PV Adaptive Tune, or
- **SP+PV***—Setpoint Tuning plus PV Adaptive Tune

Descriptions of their functions are listed with each selection in Table 4-4.

*Not available on Basic Model DC330B

ATTENTION Selecting **Gain Scheduling** in the Control or Control 2 Set Up groups automatically disables Accutune for that group.

Accutune group prompts

Table 4-4 lists all the function prompts in the Accutune Set Up group and their definitions.

Table 4-4 Accutune Group Definitions

Lower Display Prompt	Upper Display Range of Setting or Selection	Parameter Definition
FUZZY	DISABL ENABLE ENABL2 ENAB12	<p>FUZZY OVERSHOOT SUPPRESSION—Can be enabled or disabled independently of whether Demand Tuning or SP Tuning is enabled or disabled.</p> <p>DISABLE—Disables Fuzzy Overshoot Suppression.</p> <p>ENABLE ON LOOP 1 ONLY—The UDC uses Fuzzy Logic to suppress or minimize any overshoot that may occur when PV approaches SP. It will not recalculate any new tuning parameters.</p> <p>ENABLE ON LOOP 2 ONLY—Same as ENABLE except for Loop 2 only.</p> <p>ENABLE ON BOTH LOOPS—Same as ENABLE except for both Loops.</p>

Lower Display Prompt	Upper Display Range of Setting or Selection	Parameter Definition
ACCUTUNE	DISABL TUNE SP TUN+PV SP+PV	<p>ACCUTUNE for Loop 1</p> <p>DISABLE —Disables the Accutune function.</p> <p>DEMAND TUNING—If TUNE is selected, and tuning is initiated through the operator interface or digital input (if configured), the algorithm calculates new tuning parameters and enters them into the tuning group. This tuning requires no process knowledge and does not require line out for initialization.</p> <p>SETPOINT TUNING —This selection tunes on setpoint changes only. It employs time domain analysis to accelerate line out at any desired setpoint without prior initialization or process knowledge. SP is the recommended start-up mode—to be used when no knowledge of the process tuning values is available. In the Start-up mode, and after enabling ACCUTUNE, the operator simply lines out the process variable in manual mode, selects the desired SP value and switches to automatic mode.</p> <p>DEMAND TUNING PLUS PV ADAPTIVE TUNE—This selection provides “TUNE” On Demand tuning plus PV Adaptive tuning whenever a PV process disturbance of 0.3 % span or greater occurs. It will take 1-1/2 process cycles around setpoint before any process recognition and re-tuning can occur due to PV disturbances.</p> <p>SETPOINT TUNING PLUS PV ADAPTIVE TUNE—This selection tunes on setpoint changes but also whenever a PV process disturbance of 0.3 % span or greater occurs. It will take 1-1/2 process cycles around setpoint before any process recognition and re-tuning can occur due to PV disturbances.</p>
ACCUTUN2	DISABL TUNE SP TUN+PV SP+PV	<p>ACCUTUNE for Loop 2—Available only if configured for 2-Loop or Cascade control.</p> <p>DISABLE ACCUTUNE—Disables the Accutune function for Loop 2.</p> <p>DEMAND TUNING—Same as ACCUTUNE.</p> <p>SETPOINT TUNING—Same as ACCUTUNE.</p> <p>DEMAND TUNING PLUS PV ADAPTIVE TUNE—Same as ACCUTUNE.</p> <p>SETPOINT TUNING PLUS PV ADAPTIVE TUNE—Same as ACCUTUNE.</p>
SP CHANG*	5 to 15 %	<p>SETPOINT CHANGE LOOP 1—The minimum setpoint change on Loop 1 that will result in re-tuning must be configured between 5 % and 15 %; i.e., if the range is 0 to 2400 and 5 % is configured, re-tuning will occur if the setpoint change is 120 or larger.</p>

Lower Display Prompt	Upper Display Range of Setting or Selection	Parameter Definition
KPG*	0.10 to 10.00	<p>PROCESS GAIN LOOP 1—This is the Gain of the process being tuned on Loop 1. It is automatically calculated during tuning process. This is normally a READ only value. It should only need to be changed if the controller fails to identify the process. In this case, set the value to the algebraic value of PV in percent, divided by output in percent while in the manual mode.</p> <p>ATTENTION Note you must disable Accutune to change tuning constant values from the keyboard.</p>
SP CHAN2*	5 to 15 %	<p>SETPOINT CHANGE LOOP 2—The minimum setpoint change on Loop 2 that will result in re-tuning must be configured between 5 % and 15 %.</p>
KPG 2*	0.10 to 10.00	<p>PROCESS GAIN LOOP 2—This is the Gain of the process being tuned on Loop 2. It is automatically calculated during tuning process. This is normally a READ only value. It should only need to be changed if the controller fails to identify the process. In this case, set the value to the algebraic value of PV in percent, divided by output in percent while in the manual mode.</p> <p>ATTENTION Note you must disable Accutune to change tuning constant values from the keyboard.</p>
CRITERIA*	NORMAL FAST	<p>TUNING CRITERIA (SETPOINT ADAPTIVE)—Select a criteria best suited for your process on Loop 1.</p> <p>NORMAL—Original critical damping (no overshoot).</p> <p>FAST—A more aggressive tuning with a minimal possible overshoot of less than 0.5 %.</p>
CRITERA2*	NORMAL FAST	<p>TUNING CRITERIA FOR LOOP 2 (SETPOINT ADAPTIVE)—Select a criteria best suited for your process on Loop 2.</p> <p>NORMAL—Original critical damping (no overshoot).</p> <p>FAST—A more aggressive tuning with a minimal possible overshoot of less than 0.5 %. For Example: Slightly underdamped</p>

Lower Display Prompt	Upper Display Range of Setting or Selection	Parameter Definition
<p>AT ERROR or AT ERR 2 (depending on loop)</p> <p>Read Only</p>	<p>RUNING</p> <p>NONE</p> <p>OUTLIM*</p> <p>IDFAIL*</p> <p>ABORT</p> <p>LOW PV*</p>	<p>ACCUTUNE ERROR STATUS—When an error is detected in the Accutune process, an error prompt will appear.</p> <p>RUNNING—An Accutune process is still active checking process gain, even though “T” is not lit. It does not affect keyboard operation.</p> <p>NONE—No errors occurred during last Accutune procedure.</p> <p>OUTPUT REACHED LIMITS (HIGH OR LOW)—Output set insufficiently to get to SP value. ATTENTION This error will cause the controller to switch from Automatic to Manual mode. The output is then set to the value present at the beginning of the Accutune process.</p> <p>IDENTIFICATION PROCESS FAILED—An illegal value for Gain, Rate, or Reset was calculated.</p> <p>CURRENT ACCUTUNE PROCESS ABORTED—Caused by one of the following conditions:</p> <ul style="list-style-type: none"> • changing to manual mode • digital input detected • changing SP while PV (error) tune in progress • in heat region of output but a cool output is calculated, or vice versa. <p>LOW PV—PV not changed sufficiently or the PV has increased by more than 4 % and Deadtime not determined.</p>

*Applies to SP and SP+PV tuning only.

4.6 Algorithm Data Set Up Group

Introduction

This data deals with various algorithms residing in the controller:

- Control algorithms,
- Input Math algorithms,
- selecting the 1 or 2 PID Loops,
- Output Override,
- 2 Eight Segment Characterizers,
- the Timer function,
- Totalizer function, and
- Gain Scheduling.

ATTENTION Math option (two algorithms, two characterizers, totalizer) and Two Loops of Control are only available on Expanded Model DC330E.

Algorithm group prompts

Table 4-5 lists all the function prompts in the Algorithm Set Up group and their definitions.

Table 4-5 Algorithm Group Definitions

Lower Display Prompt	Upper Display Range of Setting or Selection	Parameter Definition
CONT ALG	ON-OFF	<p>The CONTROL ALGORITHM lets you select the type of control that is best for your process.</p> <p>ON/OFF is the simplest control type. The output can be either ON (100 %) or OFF (0 %). The Process Variable (PV) is compared with the setpoint (SP) to determine the sign of the error ($ERROR = PV - SP$). The ON/OFF algorithm operates on the sign of the error signal.</p> <p>In Direct Acting Control, when the error signal is positive, the output is 100 %; and when the error signal is negative, the output is 0 %. If the control action is reverse, the opposite is true. An adjustable overlap (Hysteresis Band) is provided between the on and off states.</p> <p><i>Other prompts affected: OUT HYST</i></p> <p>DUPLEX ON/OFF is an extension of this algorithm when the output is configured for Duplex. It allows the operation of a second ON/OFF output. There is a deadband between the operating ranges of the two inputs and an adjustable overlap (hysteresis) of the on and off states of each output. Both Deadband and Hysteresis are separately adjustable. With no relay action the controller will read 50 %.</p> <p><i>Other prompts affected: OUT HYST and DEADBAND</i></p>

Lower Display Prompt	Upper Display Range of Setting or Selection	Parameter Definition
<p>CONT ALG</p>	<p>PID A</p> <p>ATTENTION PID A should not be used for Proportional only action; i.e., no integral (reset) action. Instead, use PD+MR with rate set to 0.</p>	<p>PID A is normally used for three-mode control. This means that the output can be adjusted somewhere between 100 % and 0 %. It applies all three control actions—Proportional (P), Integral (I), and Derivative (D)—to the error signal.</p> <p><u>Proportional (Gain)</u>—Regulates the controller's output in proportion to the error signal (the difference between Process Variable and Setpoint).</p> <p><u>Integral (Reset)</u>—Regulates the controller's output to the size of the error and the time the error has existed. (The amount of corrective action depends on the value of proportional Gain.)</p> <p><u>Derivative (Rate)</u>—Regulates the controller's output in proportion to the rate of change of the error. (The amount of corrective action depends on the value of proportional Gain.)</p>
	<p>PID B</p>	<p>PID B—Unlike the PID A equation, the controller gives only an integral response to a setpoint change, with no effect on the output due to the gain or rate action, and it gives full response to PV changes. Otherwise controller action is as described for the PID A equation. See note on PID A.</p>
	<p>PD+MR</p>	<p>PD WITH MANUAL RESET is used whenever integral action is not wanted for automatic control. The equation is computed with no integral contribution. The MANUAL RESET, which is operator adjustable, is then added to the present output to form the controller output.</p> <p>Switching between manual and automatic mode will be bumpless.</p> <p>If you select PD with Manual Reset you can also configure the following variations:</p> <ul style="list-style-type: none"> • PD (Two Mode) control, • P (Single Mode) control. <p>Set Rate (D) to 0.</p> <p><i>Other prompts affected: MAN RSET in the Tuning Set Up group</i></p>

Lower Display Prompt	Upper Display Range of Setting or Selection	Parameter Definition
CONT ALG (continued)	3PSTEP	<p>THREE POSITION STEP—The Three Position Step Control algorithm allows the control of a valve (or other actuator) with an electric motor driven by two controller relay outputs; one to move the motor upscale, the other downscale without a feedback slidewire linked to the motor shaft. The deadband is adjustable in the same manner as the duplex output algorithm.</p> <p>The Three Position Step Control algorithm provides an output display (OUT) which is an estimated motor position, since the motor is not using any slidewire feedback. Although this output indication is only an approximation, it is “corrected” each time the controller drives the motor to one of its stops (0 % or 100 %). It avoids all the control problems associated with the feedback slidewire (wear, dirt, noise). When operating in this algorithm, the estimated OUT display is shown to the nearest percent (i.e., no decimal).</p> <p>Refer to the <i>Operation</i> section for motor position displays.</p> <p>As a customer configurable option, when a second input board is installed, the motor slidewire can be connected to the controller. The actual slidewire position is then shown on the lower display as POS. This value is used for display only. It is NOT used in the Three Position Step algorithm. To configure this option, set Input 2 actuation to SLIDEW. Calibrate the slidewire.</p> <p><i>Other prompts affected: DEADBAND</i></p>
<p>PIDLOOPS*</p> <p>*Only available on Expanded Model DC330E Dual loop.</p>	<p>1 LOOP</p> <p>2LOOPS*</p> <p>CASCAD*</p>	<p>PID LOOPS—This is the PID loop selection.</p> <p>1 LOOP—Select to use one loop of control.</p> <p>2 LOOPS—Select to use two PID loops of control, each with two sets of tuning parameters and a set of control parameters.</p> <p>CASCADE—Select for Cascade Control. In a cascade control system the output of one PID loop is used to adjust the setpoint of the second control loop and the second loop’s output actually adjusts the final control element.</p> <p>ATTENTION To enable a cascade loop, hold in the SETPOINT SELECT key until the RSP Annunciator lights and an “I” appears as the upper display’s leftmost character to indicate Cascade mode. Pressing the key again disables the Cascade Loop and the annunciators turn off.</p>
CONT2ALG		<p>The CONTROL 2 ALGORITHM lets you select the type of control for Loop 2 that is best for your process. Only available if the controller is configured for Cascade or 2-Loop control.</p> <p>3Pstep and On/Off are not available for the second control loop.</p>

Lower Display Prompt	Upper Display Range of Setting or Selection	Parameter Definition
	<p>PID A</p> <p>ATTENTION PID A should not be used for Proportional only action; i.e., no integral (reset) action. Instead, use PD+MR with rate set to 0.</p> <p>PID B</p> <p>PD+MR</p>	<p>PID A is normally used for three-mode control. This means that the output can be adjusted somewhere between 100 % and 0 %. It applies all three control actions—Proportional (P), Integral (I), and Derivative (D)—to the error signal.</p> <p><u>Proportional (Gain)</u>—Regulates the controller’s output in proportion to the error signal (the difference between Process Variable and Setpoint).</p> <p><u>Integral (Reset)</u>—Regulates the controller’s output to the size of the error and the time the error has existed. (The amount of corrective action depends on the value of proportional Gain.)</p> <p><u>Derivative (Rate)</u>—Regulates the controller’s output in proportion to the rate of change of the error. (The amount of corrective action depends on the value of proportional Gain.)</p> <p>PID B—Unlike the PID A equation, the controller gives only an integral response to a setpoint change, with no effect on the output due to the gain or rate action, and it gives full response to PV changes. Otherwise controller action is as described for the PID A equation. See note on PID A.</p> <p>PD WITH MANUAL RESET is used whenever integral action is not wanted for automatic control. The equation is computed with no integral contribution. The MANUAL RESET, which is operator adjustable, is then added to the present output to form the controller output.</p> <p>Switching between manual and automatic mode will be bumpless.</p> <p>If you select PD with Manual Reset you can also configure the following variations</p> <ul style="list-style-type: none"> • PD (Two Mode) control, • P (Single Mode) control. <p>Set Rate (D) to 0.</p> <p>Other prompts affected: MANRSET3</p>
<p>OUT OVRD</p>	<p>DISABL</p> <p>HI SEL</p> <p>LO SEL</p>	<p>OUTPUT OVERRIDE SELECT—This selection lets you select high or low output override. Only available if the controller is configured for 2-Loop operation. (NOTE 1)</p> <p>ATTENTION Loop 1 must be in Automatic for this selection to work. While the output is being overridden, an “O” appears as the leftmost digit of the upper display.</p> <p>DISABLE—Disables Output Override.</p> <p>HIGH SELECT—The controller will select the higher of output 1 or output 2 and direct it to output 1 rear terminals.</p> <p>LOW SELECT—The controller will select the lower of output 1 or output 2 and direct it to output 1 rear terminals.</p>

Lower Display Prompt	Upper Display Range of Setting or Selection	Parameter Definition
TIMER	ENABLE DISABL	TIMER allows you to enable or disable the timer option. The timer option allows you to configure a timeout period and to select timer start by either the keyboard (RUN/HOLD key) or Alarm 2. A digital input can also be configured to start the timer. When the timer is enabled, it has exclusive control of the alarm 1 relay; any previous alarm configuration is ignored. At timeout, the timer is ready to be re-activated by whatever action has been configured. Alarm 1 is activated at the end of the timeout period.
PERIOD	0:00 to 99:59	PERIOD allows you to configure the length of timeout period (from 0 to 99 hours:59 minutes).
START	KEY ALARM2	START allows you to select whether the timer starts with the keyboard (Run/Hold key) or Alarm 2.
L DISP	TI REM E TIME	L DISP allows you to select whether time remaining (TI REM) or elapsed time (E TIME) is displayed for the timer option. The time is shown on the lower display in HH:MM format along with a rotating “clock” character. <ul style="list-style-type: none"> • If the “clock” rotation is <i>clockwise</i>, elapsed time is indicated. • If the “clock” rotation is <i>counterclockwise</i>, time remaining is indicated.

INPUT MATH ALGORITHMS—The controller is provided with two input algorithms. Each algorithm can be configured to provide a derived (calculated) PV or a derived Remote setpoint. Up to three inputs may be applied to the calculation. In addition, the two algorithms may be “linked” to combine two calculations by configuring one algorithm to be an input to the other algorithm. See Inputs A, B, and C for definitions per equation.

All algorithms operate in engineering units except Feedforward which operates in percent of output units.

ATTENTION For the General Math functions, when Input C is set to NONE, the value of Input C used in the functions is automatically set to 1.0, except for Summer where it is set to 0.0.

INP ALG1	NONE	INPUT ALGORITHM 1 has the following selections from which to choose: NONE —No algorithm configured
	W AVG* *Standard feature on DC330E	WEIGHTED AVERAGE —When you configure for Weighted Average, the controller will compute a PV or SP for the control algorithm from the following equation: $PV = \frac{(\text{Input A} \times \text{Ratio A} + \text{Bias A}) + (K \times \text{Input B} \times \text{Ratio B} + \text{Bias B})}{(1 + K)}$ Both Inputs must have the same range in engineering units.
	F FWRD* *Standard feature on DC330E	FEEDFORWARD SUMMER —Feedforward uses Input A, following a Ratio and Bias calculation as a value summed directly with the PID computed output value and sent, as an output value, to the final control element. Applies to Loop 1 only. (NOTE 1) This algorithm will only function in automatic mode. The following formula applies: Controller Output = PID Output + (Input A x Ratio A + Bias A) x (100/Input A Range)

Lower Display Prompt	Upper Display Range of Setting or Selection	Parameter Definition
	FFWDMu	<p>FEEDFORWARD MULTIPLIER—Feedforward uses Input A, following a Ratio and Bias calculation as a value multiplied directly with the PID computed output value and sent, as an output value, to the final control element. (NOTE 1)</p> <p>The following formula applies:</p> $\text{Controller Output} = \text{PID Output} \times (\text{Input A} \times \text{Ratio A} + \text{Bias A}) / \text{Input A Range}$
	RELHUM	<p>RELATIVE HUMIDITY—Input 1 reads the wet bulb temperature. Input 2 reads the dry bulb temperature. Both inputs must be 100 ohm RTD inputs.</p> <p>ATTENTION The Relative Humidity selection will automatically force both Analog Input actuators to the 100 ohm low setting.</p> <p>The controller will indicate measured Relative Humidity as a Process Variable (PV) with a setpoint range of 0 % to 100 % RH.</p>
	SUMMER	<p>SUMMER WITH RATIO AND BIAS—The following formula applies:</p> $\text{PV} = (\text{Input A} \times \text{Ratio A} + \text{Bias A}) + (\text{Input B} \times \text{Ratio B} + \text{Bias B}) + (\text{Input C} \times \text{Ratio C} + \text{Bias C})$
	HI SEL	<p>INPUT HIGH SELECT WITH RATIO AND BIAS—This selection specifies the PV or SP as the higher of Input 1 or Input 2. The following formula applies:</p> $\text{PV} = \text{higher of } (\text{Input A} \times \text{Ratio A} + \text{Bias A}) \text{ or } (\text{Input B} \times \text{Ratio B} + \text{Bias B})$
	LO SEL	<p>INPUT LOW SELECT WITH RATIO AND BIAS—This selection specifies the PV or SP as the lower of Input 1 or Input 2. The following formula applies:</p> $\text{PV} = \text{lower of } (\text{Input A} \times \text{Ratio A} + \text{Bias A}) \text{ or } (\text{Input B} \times \text{Ratio B} + \text{Bias B})$
	MuDIV (note 2)	<p>MULTIPLIER DIVIDER WITH SQUARE ROOT—The following formula applies:</p> $*PV = K \times \sqrt{\frac{(\text{Input A} \times \text{Ratio A} + \text{Bias A}) \times (\text{Input C} \times \text{Ratio C} + \text{Bias C})}{(\text{Input B} \times \text{Ratio B} + \text{Bias B})}} \times (\text{Calc Hi} - \text{Calc Lo})$ <p><i>See Figure 4-1 at the end of this section for an example of Mass Flow Compensation using Multiplier/Divider Algorithm.</i></p>
	MULT (note 2)	<p>MULTIPLIER WITH SQUARE ROOT—The following formula applies:</p> $*PV = K \times \sqrt{(\text{Input A} \times \text{Ratio A} + \text{Bias A}) \times (\text{Input C} \times \text{Ratio C} + \text{Bias C}) \times (\text{Input B} \times \text{Ratio B} + \text{Bias B})} \times (\text{Calc Hi} - \text{Calc Lo})$
	MuDIV	<p>MULTIPLIER DIVIDER—The following formula applies:</p> $*PV = K \times \frac{(\text{Input A} \times \text{Ratio A} + \text{Bias A}) \times (\text{Input C} \times \text{Ratio C} + \text{Bias C})}{(\text{Input B} \times \text{Ratio B} + \text{Bias B})} \times (\text{Calc Hi} - \text{Calc Lo})$
	MULT	<p>MULTIPLIER—The following formula applies:</p> $*PV = K \times [(\text{Input A} \times \text{Ratio A} + \text{Bias A}) \times (\text{Input C} \times \text{Ratio C} + \text{Bias C}) \times (\text{Input B} \times \text{Ratio B} + \text{Bias B})] \times (\text{Calc Hi} - \text{Calc Lo})$
	CARB A	<p>CARBON POTENTIAL A—Make this selection if you have a Cambridge or Marathon monitor type Zirconium Oxide sensor.</p>

Lower Display Prompt	Upper Display Range of Setting or Selection	Parameter Definition
	CARB B	CARBON POTENTIAL B —Make this selection if you have a Corning type Zirconium Oxide sensor. This algorithm requires a temperature range within the region of 1400 to 2000°F.
	CARB C	CARBON POTENTIAL C —Make this selection if you have an A.A.C.C. type Zirconium Oxide sensor. This algorithm requires a temperature range within the region of 1400 °F to 2000 °F.
	CARB D	CARBON POTENTIAL D —Make this selection if you have a Barber Coleman, MacDhui, or Bricesco type Zirconium Oxide sensor. This algorithm requires a temperature range within the region of 1400 to 2000°F.
	FCC	CARBON POTENTIAL FCC —Make this selection if you have a Furnace Controls Corp Accucarb type Zirconium Oxide sensor. This algorithm requires a temperature range within the region of 1400 °F to 2000 °F.
	DEW PT	DEWPOINT OF CARBONIZING ATMOSPHERE —Use this selection if you are using any Zirconium Oxide Carbon Probe and you want to measure the atmosphere in terms of Dewpoint. The range is –50 °F to 100 °F or –48 °C to 38 °C. This algorithm requires a temperature range within the region of 1000 °F to 2200 °F.
	OXYGEN	PERCENT OXYGEN RANGE —Make this selection if you are using a Zirconium Oxide Oxygen Probe to measure Percent of Oxygen in a range of 0 to 40 % O ₂ . This algorithm requires a temperature range within the region of 800 °F to 3000 °F.
<p>ATTENTION The Carbon and Dewpoint selections will automatically set the first input actuation to Carbon. The Oxygen selection will automatically set the first input actuation to Oxygen.</p>		
MATH K	0.001 to 1000 floating	WEIGHTED AVERAGE RATIO OR MASS FLOW ORIFICE CONSTANT (K) FOR MATH SELECTIONS —Only applicable for algorithms W AVG or General Math selections $\sqrt{\text{MuDIV}}$, $\sqrt{\text{MULT}}$, MuDIV, or MULT.
CALC HI	–999. To 9999. Floating (in engineering units)	CALCULATED VARIABLE HIGH SCALING FACTOR FOR INPUT ALGORITHM 1 —Used only when either Summer, Input Hi/Lo, or one of the General Math functions was selected as the Input Algorithm. Range is used for either PV or RSP, depending upon Algorithm application.
CALC LO	–999. To 9999. Floating (in engineering units)	CALCULATED VARIABLE LOW SCALING FACTOR FOR INPUT ALGORITHM 1 —Used only when either Summer, Input Hi/Lo, or one of the General Math functions was selected as the Input Algorithm. Range is used for either PV or RSP, depending upon Algorithm application.

Lower Display Prompt	Upper Display Range of Setting or Selection	Parameter Definition
ALG1 INA	INP 1 INP 2 LP1OUT LP2OUT IN AL1 IN AL2 INP 3	<p>ALGORITHM 1, INPUT A SELECTION will represent one of the available selections.</p> Input 1 Input 2 Output 1 (NOTE 1) Output 2 Input Algorithm 1 Input Algorithm 2 Input 3
ALG1 INB	INP 1 INP 2 LP1OUT LP2OUT IN AL1 IN AL2 INP 3	<p>ALGORITHM 1, INPUT B SELECTION will represent one of the available selections.</p> Input 1 Input 2 Output 1 (NOTE 1) Output 2 Input Algorithm 1 Input Algorithm 2 Input 3
ALG1 INC	NONE INP 1 INP 2 LP1OUT LP2OUT IN AL1 IN AL2 INP 3	<p>ALGORITHM 1, INPUT C SELECTION will represent one of the available selections.</p> None Input 1 Input 2 Output 1 (NOTE 1) Output 2 Input Algorithm 1 Input Algorithm 2 Input 3
PCO SEL	DISABL ONLINE	<p>PERCENT CARBON SOURCE allows a live Input 3 value to be substituted for the static % CO value (PCT CO).</p> <p>DISABLED ONLINE—Input 3 must be enabled</p>
PCT CO	0.020 to 0.350 (fractional percent of CO)	<p>PERCENT CARBON is only applicable when Carbon Potential is selected. Enter the value in percent carbon monoxide that is applicable for the enriching gas used in fractional form.</p> <p>FOR EXAMPLE: Natural Gas = 20.0 % CO, then setting is 0.200 Propane Gas = 23.0 % CO, setting is 0.230</p>
ATM PRES	590.0 to 760.0 (mm Hg)	<p>ATMOSPHERIC PRESSURE COMPENSATION is only applicable when Relative Humidity is selected. Enter the value of the atmospheric pressure of the process.</p>
ALG1 BIAS	-999 to 9999 floating (in engineering units)	<p>INPUT ALGORITHM 1 BIAS—Does not apply to selections: FFWRD, FFWDM2, HISEL, or LOSEL.</p>

Lower Display Prompt	Upper Display Range of Setting or Selection	Parameter Definition
<p>INP ALG2</p> <p>ATTENTION</p> <ul style="list-style-type: none"> All Input Algorithms operate in engineering units except Feed-forward which operates in percent of range units. For General Math functions, when Input C is disabled, the value of Input C used in the functions is automatically set to 1.0. 	<p>NONE W AVG F FWR2 FFWDM2 A-B/C* HI SEL LO SEL MuDIV MULT MuDIV MULT DEW PT</p>	<p>INPUT ALGORITHM 2—The selections from which to choose are listed to the left.</p> <p>The formulas are the same as shown for IN ALG 1.</p> <p>* ATTENTION Selection A–B/C algorithm subtracts Input B with Ratio/Bias from Input A with Ratio/Bias and divides the result by Input C with Ratio/Bias using engineering units.</p> <p>EXAMPLE:</p> $PV \text{ or } SP = K \frac{(A-B)}{C} (\text{Calc Hi} - \text{Calc Lo})$
<p>MATH K2</p>	<p>0.001 to 1000 floating</p>	<p>WEIGHTED AVERAGE RATIO OR MASS FLOW ORIFICE CONSTANT (K) FOR MATH SELECTIONS—Only applicable for algorithm W AVG or General Math selections MuDIV, MULT, MuDIV, or MULT.</p>
<p>CALC HI</p>	<p>–999. To 9999. Floating (in engineering units)</p>	<p>CALCULATED VARIABLE HIGH SCALING FACTOR FOR INPUT ALGORITHM 2—Does not apply to Feedforward algorithms. Range is used for either PV or RSP, depending upon Algorithm application.</p>
<p>CALC LO</p>	<p>–999. To 9999. Floating (in engineering units)</p>	<p>CALCULATED VARIABLE LOW SCALING FACTOR FOR INPUT ALGORITHM 2—Does not apply to Feedforward algorithms. Range is used for either PV or RSP, depending upon Algorithm application.</p>
<p>ALG2 INA</p>	<p>INP 1 INP 2 LP1OUT LP2OUT IN AL1 IN AL2 INP 3</p>	<p>ALGORITHM 2, INPUT A SELECTION will represent one of the available selections.</p> <p>Input 1 Input 2 Output 1 (NOTE 1) Output 2 Input Algorithm 1 Input Algorithm 2 Input 3</p>
<p>ALG2 INB</p>	<p>INP 1 INP 2 LP1OUT LP2OUT IN AL1 IN AL2 INP 3</p>	<p>ALGORITHM 2, INPUT B SELECTION will represent one of the available selections.</p> <p>Input 1 Input 2 Output 1 (NOTE 1) Output 2 Input Algorithm 1 Input Algorithm 2 Input 3</p>
<p>ALG2 INC</p>	<p>NONE INP 1 INP 2 LP1OUT LP2OUT IN AL1 IN AL2 INP 3</p>	<p>ALGORITHM 2, INPUT C SELECTION will represent one of the available selections.</p> <p>None Input 1 Input 2 Output 1 (NOTE 1) Output 2 Input Algorithm 1 Input Algorithm 2 Input 3</p>

Lower Display Prompt	Upper Display Range of Setting or Selection	Parameter Definition
PCT H2	1.0 to 99.0 (% H ₂)	HYDROGEN CONTENT FOR DEWPOINT is only applicable when Dewpoint is selected. Enter a value for the percentage of Hydrogen content that is applicable.
ALG2BIAS	-999 to 9999 floating (in engineering units)	INPUT ALGORITHM 2 BIAS —Does not apply to selections: FFWR2, FFWM2, HI SEL, or LO SEL.

Figure 4-1 Example of Mass Flow Compensation using Multiplier/Divider Algorithm

Example - Mass Flow Compensation

A gas flow rate of 650 SCFM develops a differential pressure of 90" H₂O across an orifice plate at reference conditions of 30 psig and 140°F. Compensate this gas flow for temperature and pressure variations.

$$\text{Flow} = K \sqrt{\frac{DP_f \times P_f}{T_f} \times \frac{T_{ref}}{P_{ref}}}$$

Where:
 f = flowing conditions
 ref = reference conditions (in absolute units)

Apply Multiplier/Divider Algorithm:

$$PV = K \sqrt{\frac{(\text{Input A} \times \text{Ratio A} + \text{Bias A}) \times (\text{Input C} \times \text{Ratio C} + \text{Bias C})}{(\text{Input B} \times \text{Ratio B} + \text{Bias B})}} \times (\text{Calc HI} - \text{Calc LO})$$

Assign inputs using Engineering units:

Let:

Input A = DP_f = IN1 (in H₂O)

Input B = T_f = IN2 + Bias2 = IN2°F + 460 (°R)

Input C = P_f = IN3 + Bias3 = IN3psig + 14.7(psia)

T_{ref} = 140°F + 460 = 600°R

P_{ref} = 30 psig + 14.7 = 44.7 psia

Calc_{Hi} = 650.0
 Calc_{Lo} = 0.0 > Flow in SFCM at Reference Conditions

K = to be determined next

Note: If temperature and pressure signals are already ranged in absolute units, no Bias is required for inputs B and C.

$$PV = Q_{SCFM} = \sqrt{\frac{DP_f \times (IN3 + 14.7)}{(IN2 + 460)}} \times K^2 \times (650.0 - 0.0)$$

Note: When IN2 and IN3 are at the reference conditions of 600°R (140°F) and 44.7psia (30 psig) respectively and DP_f = 90" H₂O, the equation must calculate 650 SCFM. To accomplish this, divide the DP value by "90" to normalize the equation.

$$Q_{SCFM} = \sqrt{\frac{DP_f}{90} \times \frac{(IN3 + 14.7)}{(IN2 + 460)}} \times \frac{T_{ref}}{P_{ref}} \times 650$$

Rearranging terms:

$$Q_{SCFM} = \sqrt{\underbrace{DP_f \times \frac{(IN3 + 14.7)}{(IN2 + 460)}}_{\text{Variable}} \times \underbrace{\frac{1}{90} \times \frac{T_{ref}}{P_{ref}}}_{\text{Constant} = K^2}} \times 650$$

**Example continued
 on next page**

22049

Figure 4-1 Example of Mass Flow Compensation using Multiplier/Divider Algorithm, continued

Example - Mass Flow Compensation

Determined value of K:

$$K^2 = \frac{1}{90} \times \frac{T_{ref}}{P_{ref}} = \frac{600}{(90)(44.7)} = 0.14914$$

Therefore K = 0.386

$$Q_{SCFM} = (0.386) (650) \sqrt{\frac{DP_f \text{ (in H}_2\text{O)} \text{ (IN3 + 14.7)}}{(IN2 + 460)}}$$

K (Calc_{HI} - Calc_{LO})

Summary of Flow Values At Values Conditions

	Temp (T _f) (°R)	Pressure (T _f) (psia)	Flow (SFCM)	
			DP _f = 45" H ₂ O (50%)	DP _f = 90" H ₂ O (100%)
Reference Conditions	140°F + 460	30 psi + 14.7	459	650
	170°F + 460	50 psi + 14.7	539	763
	170°F + 460	20 psi + 14.7	395	559
	110°F + 460	50 psi + 14.7	567	802
	110°F + 460	20 psi + 14.7	415	587

22050

Table 4-5 Algorithm Group Definitions, Continued

Lower Display Prompt	Upper Display Range of Setting or Selection	Parameter Definition
8SEG CH1	DISABL INPUT1 INPUT2 L1 OUT L2 OUT	<p>8 SEGMENT CHARACTERIZER #1—An eight segment characterizer can be applied to either Input 1, Input 2, Output 1, or Output 2.</p> <p>DISABLE—Disables characterizer.</p> <p>INPUT 1—Characterizer is applied to Input 1.</p> <p>INPUT 2—Characterizer is applied to Input 2.</p> <p>LOOP 1 OUTPUT—Characterizer is applied to Loop 1 Output. (NOTE 1)</p> <p>LOOP 2 OUTPUT—Characterizer is applied to Loop 2 Output.</p> <p>There are eight (Xn) Input values and eight (Yn) Output values to be selected. The following rules apply:</p> <ul style="list-style-type: none"> • When Input 2 is used, Input 2 Ratio and Bias are applied to the Xn Values. • When one of the Loop outputs are selected, the Xn Input values are the Output from the control algorithm, and the Yn Output is the final control element action. This application is useful for non-linear control elements or Process Variable. <p>A simple example is shown in Figure 4-2.</p>
ATTENTION <i>The X values below should be entered as increasing values (from 0% to 100%) from N = 0 to 8.</i>		
X0 VALUE	0.00 to 99.99 %	X0 INPUT VALUE (X AXIS)
X1 VALUE	0.00 to 99.99 %	X1 INPUT VALUE (X AXIS)
X2 VALUE	0.00 to 99.99 %	X2 INPUT VALUE (X AXIS)
X3 VALUE	0.00 to 99.99 %	X3 INPUT VALUE (X AXIS)
X4 VALUE	0.00 to 99.99 %	X4 INPUT VALUE (X AXIS)
X5 VALUE	0.00 to 99.99 %	X5 INPUT VALUE (X AXIS)
X6 VALUE	0.00 to 99.99 %	X6 INPUT VALUE (X AXIS)
X7 VALUE	0.00 to 99.99 %	X7 INPUT VALUE (X AXIS)
X8 VALUE	0.00 to 99.99 %	X8 INPUT VALUE (X AXIS)
Y0 VALUE	0.00 to 99.99 %	Y0 INPUT VALUE (Y AXIS)
Y1 VALUE	0.00 to 99.99 %	Y1 INPUT VALUE (Y AXIS)
Y2 VALUE	0.00 to 99.99 %	Y2 INPUT VALUE (Y AXIS)
Y3 VALUE	0.00 to 99.99 %	Y3 INPUT VALUE (Y AXIS)
Y4 VALUE	0.00 to 99.99 %	Y4 INPUT VALUE (Y AXIS)
Y5 VALUE	0.00 to 99.99 %	Y5 INPUT VALUE (Y AXIS)
Y6 VALUE	0.00 to 99.99 %	Y6 INPUT VALUE (Y AXIS)
Y7 VALUE	0.00 to 99.99 %	Y7 INPUT VALUE (Y AXIS)
Y8 VALUE	0.00 to 99.99 %	Y8 INPUT VALUE (Y AXIS)

Lower Display Prompt	Upper Display Range of Setting or Selection	Parameter Definition
8SEG CH2	DISABL INPUT1 INPUT2 L1 OUT L2 OUT	<p>8 SEGMENT CHARACTERIZER #2—A second eight segment characterizer can be applied to either Input 1, Input 2, Output 1, or Output 2.</p> <p>DISABLE—Disables characterizer.</p> <p>INPUT 1—Characterizer applied to Input 1.</p> <p>INPUT 2—Characterizer applied to Input 2.</p> <p>LOOP 1 OUTPUT—Characterizer applied to Loop 1 Output. (NOTE 1)</p> <p>LOOP 2 OUTPUT—Characterizer applied to Loop 2 Output.</p> <p>There are eight (Xn) Input values and eight (Yn) Output values to be selected. The following rules apply:</p> <ul style="list-style-type: none"> • When Input 2 is used, Input 2 Ratio and Bias are applied to the Xn Values. • When one of the Loop outputs are selected, the Xn Input values are the Output from the control algorithm, and the Yn Output is the final control element action. This application is useful for non-linear control elements or Process Variable. <p>A simple example is shown in Figure 4-2.</p>
ATTENTION <i>The X values below should be entered as increasing values (from 0% to 100%) from N=0 to 8.</i>		
X0 VALU2	0.00 to 99.99 %	X0 INPUT VALUE (X AXIS)
X1 VALU2	0.00 to 99.99 %	X1 INPUT VALUE (X AXIS)
X2 VALU2	0.00 to 99.99 %	X2 INPUT VALUE (X AXIS)
X3 VALU2	0.00 to 99.99 %	X3 INPUT VALUE (X AXIS)
X4 VALU2	0.00 to 99.99 %	X4 INPUT VALUE (X AXIS)
X5 VALU2	0.00 to 99.99 %	X5 INPUT VALUE (X AXIS)
X6 VALU2	0.00 to 99.99 %	X6 INPUT VALUE (X AXIS)
X7 VALU2	0.00 to 99.99 %	X7 INPUT VALUE (X AXIS)
X8 VALU2	0.00 to 99.99 %	X8 INPUT VALUE (X AXIS)
Y0 VALU2	0.00 to 99.99 %	Y0 INPUT VALUE (Y AXIS)
Y1 VALU2	0.00 to 99.99 %	Y1 INPUT VALUE (Y AXIS)
Y2 VALU2	0.00 to 99.99 %	Y2 INPUT VALUE (Y AXIS)
Y3 VALU2	0.00 to 99.99 %	Y3 INPUT VALUE (Y AXIS)
Y4 VALU2	0.00 to 99.99 %	Y4 INPUT VALUE (Y AXIS)
Y5 VALU2	0.00 to 99.99 %	Y5 INPUT VALUE (Y AXIS)
Y6 VALU2	0.00 to 99.99 %	Y6 INPUT VALUE (Y AXIS)
Y7 VALU2	0.00 to 99.99 %	Y7 INPUT VALUE (Y AXIS)
Y8 VALU2	0.00 to 99.99 %	Y8 INPUT VALUE (Y AXIS)

Figure 4-2 Example of Eight Segment Characterizer

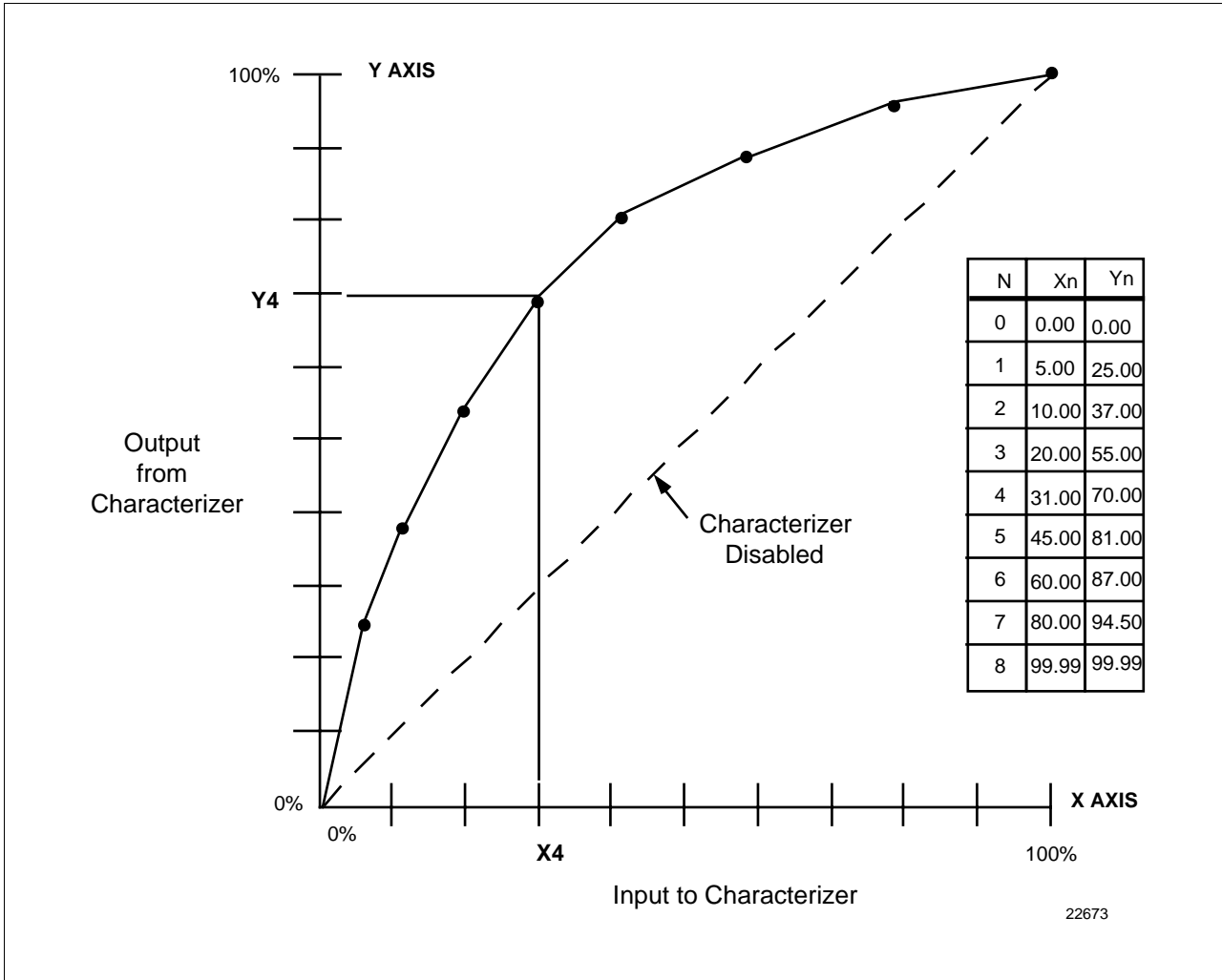


Table 4-5 Algorithm Group Definitions, Continued

Lower Display Prompt	Upper Display Range of Setting or Selection	Parameter Definition
TOTALIZE	DISABL INPUT1 IN AL1 IN AL2	<p>TOTALIZER FUNCTION calculates and displays the total flow volume as measured by Input 1 or applied to either Input Algorithm 1 or Algorithm 2 to totalize the compensated flow rate being calculated by the algorithm. Displayed value is eight digits with a configurable scale factor.</p> <p>DISABLE—Disables the totalizer function. INPUT 1—Totalizer is applied to Input 1. IN AL1—Totalizer is applied to Input Algorithm 1. IN AL2—Totalizer is applied to Input Algorithm 2.</p> <p>ATTENTION The totalizer should always be reset to initialize the counters whenever it is enabled. Otherwise, the Σ (sigma) display will blink.</p>
Σ XXXXXXX	$\Sigma * E_n$	<p>READ ONLY Current Scale Factor (Upper Display) Actual Current Totalized Value (Lower Display)</p>
TOT SCAL	*E0 = $1 \times 10^0 = 1$ *E1 = $1 \times 10^1 = 10$ *E2 = $1 \times 10^2 = 100$ *E3 = $1 \times 10^3 = 1,000$ *E4 = $1 \times 10^4 = 10,000$ *E5 = $1 \times 10^5 = 100,000$ *E6 = $1 \times 10^6 = 1,000,000$	<p>TOTALIZER SCALE FACTOR—Selects the desired Scale Factor (i.e., Multiplier).</p> <p>The desired factor is applied to the calculated value to extend the maximum flow range that can be displayed.</p>
TOT SEC	UNLOCK LOCK	<p>TOTALIZER RESET LOCK—Allows the totalizer to be reset.</p> <p>UNLOCK—Allows the totalizer value to be reset. LOCK—Prevents the totalizer value from being reset.</p>
Σ RSET ?	NO YES	<p>TOTALIZER RESET—Appears only if the totalizer is unlocked.</p> <p>NO—No Reset YES—Resets on next FUNCTION key press and displays the reset value.</p>

Lower Display Prompt	Upper Display Range of Setting or Selection	Parameter Definition
TOT RATE	SECOND MINUTE HOUR DAY ML/DAY	<p>TOTALIZER INTEGRATION RATE—Determines the rate at which the Totalizer is updated.</p> <p>SECOND —Engineering units per second MINUTE—Engineering units per minute HOUR—Engineering units per hour DAY —Engineering units per day MIL/DAY—Millions of units per day</p> <p>ATTENTION The source of the Totalizer is averaged over the sample and update rates. For example, since the loop cycle speed is six per second, then with the Totalizer Rate set at once per minute, the source is averaged six times per second and the Totalizer value is updated with this average value ÷ 60 once per second.</p>

NOTE 1: Does not apply to Three Position Step Control.

NOTE 2. If the calculated value of the quantity under the square root sign decreases to a value less than 0.010, the calculation will become linear as the calculated value decreases below 0.010.

*Where: K = 0.001 to 1000 (configurable)

Calc Hi and Calc Lo are configurable over a range of -999 to 9999

4.7 Output Algorithm Parameters Set Up Group

Introduction

This data deals with various output types in the controller, the Digital Output Status, and the Current Duplex functionality.

Output algorithm group prompts

Table 4-6 lists all the function prompts in the Output Algorithm Set Up group and their definitions.

Table 4-6 Output Algorithm Group Definitions

Lower Display Prompt	Upper Display Range of Setting or Selection	Parameter Definition
OUT ALG		<p>The OUTPUT ALGORITHM lets you select the type of output you want. Not applicable with Control algorithm prompt 3PSTEP.</p> <p>Selections are hardware dependent. For example, if the controller does not have a current output, then none of the prompts for Output Algorithms that need a current output will appear. Likewise, if the controller does not have a relay output, then none of the prompts that need a relay output will appear.</p> <p>ATTENTION For all Duplex Output forms, PID heat parameters apply for controller output greater than 50 %; PID cool parameters apply for controller output less than 50 %.</p>
	TIME	<p>TIME SIMPLEX—This output algorithm uses Digital Output 1 for Time Proportional Control. The output is updated per the Loop sampling rate selection. Time Proportional Output has a resolution of 4.44 msec. Cycle Time is adjustable from 1 to 120 seconds.</p>
	CURRNT	<p>CURRENT SIMPLEX—Type of output using one 4 mA to 20 mA signal that can be fed into a positive or negative grounded load of 0 to 1000 ohms. The signal can be recalibrated for any desired range from 4 mA to 20 mA for 0 % to 100 % output.</p>
	POSITN	<p>POSITION PROPORTIONAL SIMPLEX—Type of output using two SPDT relays and a motor which has a 100 to 1000 ohms feedback slidewire.</p> <p>Forces Input 2 to SLIDEW selection.</p> <p>ATTENTION Position Proportional is not available on two-loop or cascade controllers.</p> <p><i>Other prompts affected: DEADBAND, IN2 TYPE</i></p>
	TIME D	<p>TIME DUPLEX—This output algorithm uses Digital Outputs 1 and 2 for Duplex Time Proportional Control. The outputs are updated per the Loop sampling rate selection. Time Proportional Output has a resolution of 4.44 msec. Cycle Time is adjustable from 1 second to 120 seconds.</p>

Lower Display Prompt	Upper Display Range of Setting or Selection	Parameter Definition
OUT ALG (continued)	CUR D CUR TI TI CUR	<p>CURRENT DUPLEX is similar to current simplex but uses a second current output. The second output is usually scaled so that zero and span correspond with 0 % and 50 % output (cool zone). When the output is 0 % to 50 %, the controller uses tuning parameter set #2, when the output is 50 % to 100 % it uses set #1. <i>Other prompts affected: 4-20 RNG</i></p> <p>CURRENT/TIME DUPLEX is a variation of duplex with current active for 0 % to 50 % output (tuning set 2) and time is active 50 % to 100 % output (tuning set 1). Relay controls heat, current controls cool. <i>Other prompts affected: 4-20 RNG</i></p> <p>TIME CURRENT DUPLEX is similar to CUR TI except that current is active for 50 % to 100 % and time is active for 0 % to 50 %. Relay controls cool, current controls heat. <i>Other prompts affected: 4-20 RNG</i></p>
4-20 RNG	50 PCT 100PCT	<p>CURRENT DUPLEX RANGE ALGORITHM — Used with Output Algorithm selections CUR D, CUR TI, or TI CUR.</p> <p>CURRENT DUPLEX RANGE (SPLIT)—This setting should be used for Relay/Current and Current/Relay Duplex Outputs. It can also be used for Current Duplex when an Auxiliary Output board is present. This enables the normal control current output to provide heat control and the auxiliary current output to provide cool control. To enable this:</p> <ul style="list-style-type: none"> • AUX OUT in the Options Set Up group must be selected for Output. • The Auxiliary Current Output is scaled as desired for 0-50 % controller output. • Deadband for this configuration only applies to the Current Output. The Auxiliary Output must have the Deadband scaled in. <p>FOR EXAMPLE: If a 2 % Deadband is desired, then enter 2.0 for the Deadband selection in the Control Algorithm group. This will apply Deadband to the Current Output. In the Options group, set the Auxiliary Output 4mA VAL selection to 49.0 and the 20mA VAL selection to 0.0.</p> <p>CURRENT DUPLEX RANGE (FULL) enables the Current Output to provide both heat and cool functions for control over 0-100 % of the controller output. The PID heat parameters apply when the output is greater than 50 % and the PID cool parameters apply when the output is less than 50 %. The second current output is not required for this type of duplex operation.</p>

Lower Display Prompt	Upper Display Range of Setting or Selection	Parameter Definition
OUT2 ALG	NONE TIME CURRNT CUR D CUR TI TI CUR	<p>The OUTPUT ALGORITHM lets you select the type of output you want for the second control loop. See OUT ALG for definitions.</p> <p>NONE TIME SIMPLEX CURRENT SIMPLEX (AUX OUT) CURRENT DUPLEX (AUX OUT) CURRENT/TIME DUPLEX TIME/CURRENT DUPLEX</p> <p>ATTENTION If Time Duplex or TPSC is selected as the first control loop output, then TIME, CUR TI, and TI CUR are not available as the second control loop output.</p>
RLYSTATE	1OF2OF 1ON2OF 1OF2ON 1ON2ON	<p>DIGITAL OUTPUT STATUS AT 0 % OUTPUT allows the following selections:</p> <p>1OF2OF Output 1 de-energized Output 2 de-energized</p> <p>1ON2OF Output 1 energized Output 2 de-energized</p> <p>1OF2ON Output 1 de-energized Output 2 energized</p> <p>1ON2ON Output 1 energized Output 2 energized</p>
RLY TYPE	MECHAN SOL ST	<p>RELAY CYCLE TIME INCREMENT selection is used only for Time Simplex and Duplex output configurations and affects both loops. This configuration sets the increment size of the relay cycle times in the Tuning and Tuning 2 Set Up groups.</p> <p>ELECTROMECHANICAL RELAY—Cycle time in one-second increments.</p> <p>SOLID STATE RELAY—Cycle time in 1/3 second increments. This is useful for solid state relay applications that require shorter cycle times. DO NOT use this setting unless cycle times of less than 1 second are required.</p> <p>The Lockout selection must be set to NONE in order to view this selection.</p>

4.8 Input 1 Parameters Set Up Group

Introduction These are the parameters required for Input 1: actuation, transmitter characterization, high and low range values in engineering units, ratio, bias, filter, burnout, and emissivity.

Input 1 group prompts Table 4-7 lists all the function prompts in the Input 1 Set Up group and their definitions.

Table 4-7 Input 1 Group Definitions

Lower Display Prompt	Upper Display Range of Setting or Selection	Parameter Definition
<p>IN1 TYPE</p> <p>ATTENTION Changing the input type will result in the loss of Field Calibration values and will restore Factory Calibration values.</p>	<p>DISABL B TC E TC H E TC L J TC H J TC L K TC H K TC L NNM H NNM L NM90 H NM90 L NIC TC R TC S TC T TC H T TC L W TC H W TC L 100 PT 100 LO 200 PT 500 PT RAD RH RAD RI 0-20mA 4-20mA 0-10mV 0-50mV 0-5 V 1-5 V 0-10 V CARBON OXYGEN</p>	<p>INPUT 1 ACTUATION TYPE – This selection determines what actuation you are going to use for Input 1.</p> <p>DISABLE—Disables Input. B TC—B Thermocouple E TC H—E Thermocouple High E TC L—E Thermocouple Low J TC H—J Thermocouple High J TC L—J Thermocouple Low K TC H—K Thermocouple High K TC L—K Thermocouple Low NNM H—Ni-Ni-Moly Thermocouple High NNM L—Ni-Ni-Moly Thermocouple Low NM90 H—NiMo-NiCo Thermocouple High NM90 L—NiMo-NiCo Thermocouple Low NIC TC—Nicosil-Nisil Thermocouple R TC—R Thermocouple S TC—S Thermocouple T TC H—T Thermocouple High T TC L—T Thermocouple Low W TC H—W5W26 Thermocouple High W TC L—W5W26 Thermocouple Low 100 PT—100 Ohm RTD High 100 LO—100 Ohm RTD Low 200 PT—200 Ohm RTD 500 PT—500 Ohm RTD RAD RH—Radiumatic RH RAD RI—Radiumatic RI 0-20mA—0 to 20 Milliamperes 4-20mA—4 to 20 Milliamperes 0-10mV—0 to 10 Millivolts 0-50mV—0 to 50 Millivolts 0-5 V—0 to 5 Volts 1-5 V—1 to 5 Volts 0-10 V—0 to 10 Volts Carbon Oxygen</p>

Lower Display Prompt	Upper Display Range of Setting or Selection	Parameter Definition																																																																																					
XMITTER	Select one from the columns below <table border="0"> <tr> <td>B TC</td> <td>S TC</td> </tr> <tr> <td>E TC H</td> <td>T TC H</td> </tr> <tr> <td>E TC L</td> <td>T TC L</td> </tr> <tr> <td>J TC H</td> <td>W TC H</td> </tr> <tr> <td>J TC L</td> <td>W TC L</td> </tr> <tr> <td>K TC H</td> <td>100 PT</td> </tr> <tr> <td>K TC L</td> <td>100 LO</td> </tr> <tr> <td>NNM H</td> <td>200 PT</td> </tr> <tr> <td>NNM L</td> <td>500 PT</td> </tr> <tr> <td>NM90 H</td> <td>RAD RH</td> </tr> <tr> <td>NM90 L</td> <td>RAD RI</td> </tr> <tr> <td>NIC TC</td> <td>LINEAR</td> </tr> <tr> <td>R TC</td> <td>SQROOT</td> </tr> <tr> <td></td> <td>ANALYTIC</td> </tr> </table>	B TC	S TC	E TC H	T TC H	E TC L	T TC L	J TC H	W TC H	J TC L	W TC L	K TC H	100 PT	K TC L	100 LO	NNM H	200 PT	NNM L	500 PT	NM90 H	RAD RH	NM90 L	RAD RI	NIC TC	LINEAR	R TC	SQROOT		ANALYTIC	<p>TRANSMITTER CHARACTERIZATION—This selection lets you instruct the controller to characterize a linear input to represent a non-linear one.</p> <p>ATTENTION Prompt only appears when a linear actuation is selected at prompt IN1 TYPE.</p> <p>FOR EXAMPLE: If input 1 is a 4 to 20 mA signal, but the signal represents a type K thermocouple, select K TC H and the controller will characterize the 4 to 20 mA signal so that it is treated as a type K thermocouple input (high range).</p> <p>Parameter definitions are the same as in IN1 TYPE.</p>																																																									
B TC	S TC																																																																																						
E TC H	T TC H																																																																																						
E TC L	T TC L																																																																																						
J TC H	W TC H																																																																																						
J TC L	W TC L																																																																																						
K TC H	100 PT																																																																																						
K TC L	100 LO																																																																																						
NNM H	200 PT																																																																																						
NNM L	500 PT																																																																																						
NM90 H	RAD RH																																																																																						
NM90 L	RAD RI																																																																																						
NIC TC	LINEAR																																																																																						
R TC	SQROOT																																																																																						
	ANALYTIC																																																																																						
ANALYTIC* * Expanded models only	<table border="0"> <tr> <td>NONE</td> <td></td> </tr> <tr> <td>PH</td> <td></td> </tr> <tr> <td>ORP mV</td> <td></td> </tr> <tr> <td>CONDmS</td> <td></td> </tr> <tr> <td>CONDuS</td> <td></td> </tr> <tr> <td>RSTVM^</td> <td></td> </tr> <tr> <td>TDS PPM</td> <td></td> </tr> <tr> <td>TDS PPb</td> <td></td> </tr> <tr> <td>CONCPt</td> <td></td> </tr> <tr> <td>DO PPM</td> <td></td> </tr> <tr> <td>DO PPb</td> <td></td> </tr> </table>	NONE		PH		ORP mV		CONDmS		CONDuS		RSTVM^		TDS PPM		TDS PPb		CONCPt		DO PPM		DO PPb		<p>Analytic Input Selections and Ranges—This prompt appears only when XMITTER is set to ANALYTIC. Choosing an Analytic setting here will set the Input Range to appropriate Hi and Low values for that analytical application. You can adjust the Input Range if you want.</p> <table border="0"> <thead> <tr> <th></th> <th style="text-align: center;"><u>Input Hi</u></th> <th style="text-align: center;"><u>Input Low</u></th> </tr> </thead> <tbody> <tr> <td>NONE</td> <td style="text-align: center;">as configured</td> <td style="text-align: center;">as configured</td> </tr> <tr> <td>pH</td> <td style="text-align: center;">14.00</td> <td style="text-align: center;">0.00</td> </tr> <tr> <td>ORP</td> <td style="text-align: center;">1600</td> <td style="text-align: center;">-999</td> </tr> <tr> <td>(millivolts)</td> <td></td> <td></td> </tr> <tr> <td>CONDUCTIVITY</td> <td style="text-align: center;">20.00</td> <td style="text-align: center;">0.00</td> </tr> <tr> <td>(milli Siemens)</td> <td></td> <td></td> </tr> <tr> <td>CONDUCTIVITY</td> <td style="text-align: center;">2000</td> <td style="text-align: center;">0.00</td> </tr> <tr> <td>(micro Siemens)</td> <td></td> <td></td> </tr> <tr> <td>RESISTIVITY</td> <td style="text-align: center;">2000</td> <td style="text-align: center;">0.00</td> </tr> <tr> <td>(Megaohms)</td> <td></td> <td></td> </tr> <tr> <td>TOTAL DISSOLVED SOLIDS</td> <td style="text-align: center;">9999</td> <td style="text-align: center;">0.00</td> </tr> <tr> <td>(parts per million)</td> <td></td> <td></td> </tr> <tr> <td>TOTAL DISSOLVED SOLIDS</td> <td style="text-align: center;">9999</td> <td style="text-align: center;">0.00</td> </tr> <tr> <td>(parts per billion)</td> <td></td> <td></td> </tr> <tr> <td>CONCENTRATION</td> <td style="text-align: center;">20.00</td> <td style="text-align: center;">0.00</td> </tr> <tr> <td>(parts per thousand)</td> <td></td> <td></td> </tr> <tr> <td>DISSOLVED OXYGEN</td> <td style="text-align: center;">20.00</td> <td style="text-align: center;">0.00</td> </tr> <tr> <td>(parts per million)</td> <td></td> <td></td> </tr> <tr> <td>DISSOLVED OXYGEN</td> <td style="text-align: center;">2000</td> <td style="text-align: center;">0.00</td> </tr> <tr> <td>(parts per billion)</td> <td></td> <td></td> </tr> </tbody> </table>		<u>Input Hi</u>	<u>Input Low</u>	NONE	as configured	as configured	pH	14.00	0.00	ORP	1600	-999	(millivolts)			CONDUCTIVITY	20.00	0.00	(milli Siemens)			CONDUCTIVITY	2000	0.00	(micro Siemens)			RESISTIVITY	2000	0.00	(Megaohms)			TOTAL DISSOLVED SOLIDS	9999	0.00	(parts per million)			TOTAL DISSOLVED SOLIDS	9999	0.00	(parts per billion)			CONCENTRATION	20.00	0.00	(parts per thousand)			DISSOLVED OXYGEN	20.00	0.00	(parts per million)			DISSOLVED OXYGEN	2000	0.00	(parts per billion)		
NONE																																																																																							
PH																																																																																							
ORP mV																																																																																							
CONDmS																																																																																							
CONDuS																																																																																							
RSTVM^																																																																																							
TDS PPM																																																																																							
TDS PPb																																																																																							
CONCPt																																																																																							
DO PPM																																																																																							
DO PPb																																																																																							
	<u>Input Hi</u>	<u>Input Low</u>																																																																																					
NONE	as configured	as configured																																																																																					
pH	14.00	0.00																																																																																					
ORP	1600	-999																																																																																					
(millivolts)																																																																																							
CONDUCTIVITY	20.00	0.00																																																																																					
(milli Siemens)																																																																																							
CONDUCTIVITY	2000	0.00																																																																																					
(micro Siemens)																																																																																							
RESISTIVITY	2000	0.00																																																																																					
(Megaohms)																																																																																							
TOTAL DISSOLVED SOLIDS	9999	0.00																																																																																					
(parts per million)																																																																																							
TOTAL DISSOLVED SOLIDS	9999	0.00																																																																																					
(parts per billion)																																																																																							
CONCENTRATION	20.00	0.00																																																																																					
(parts per thousand)																																																																																							
DISSOLVED OXYGEN	20.00	0.00																																																																																					
(parts per million)																																																																																							
DISSOLVED OXYGEN	2000	0.00																																																																																					
(parts per billion)																																																																																							
IN1 HI	-999. To 9999. Floating (in engineering units)	<p>INPUT 1 HIGH RANGE VALUE in engineering units is displayed for all inputs but can only be configured for linear or square root transmitter characterization.</p> <p>Scale the #1 input signal to the display value you want for 100 %.</p> <p>EXAMPLE: Actuation (Input) = 4 to 20 mA Process Variable = Flow Range of Flow = 0 to 250 Gal/Min High Range display value = 250 Then 20 mA = 250 Gal/Min</p> <p>The control setpoint will be limited by the range of units selected here.</p>																																																																																					

Lower Display Prompt	Upper Display Range of Setting or Selection	Parameter Definition
IN1 LO	–999. To 9999. Floating (in engineering units)	INPUT 1 LOW RANGE VALUE in engineering units is displayed for all inputs but can only be configured for linear or square root transmitter characterization. Scale the #1 input signal to the display value you want for 0 %. See example above. The control setpoint for Input 1 will be limited by the range of units selected here.
RATIO 1	–20.00 to 20.00 Floats to 3 decimal places	RATIO ON INPUT 1 —Select the Ratio value you want on Input 1.
BIAS IN1	–999. to 9999. (in engineering units)	BIAS ON INPUT 1 — Bias is used to compensate the input for drift of an input value due to deterioration of a sensor, or some other cause. Select the bias value you want on Input 1.
FILTER 1	0 to 120 seconds No filter = 0	FILTER FOR INPUT 1 —A software digital filter is provided for Input 1 to smooth the input signal. You can configure the first order lag time constant from 1 to 120 seconds. If you do not want filtering, enter 0.
BURNOUT	NONE UP DOWN NO_FS	<p>BURNOUT PROTECTION (SENSOR BREAK) provides most input types with upscale or downscale protection if the input fails.</p> <p>1-5V, 0-10V, or 4-20 mA inputs require no burnout or NONE selection.</p> <p>NO BURNOUT—Pre-configured Failsafe output applied if failed input is detected (does not apply for an input out of range). Error message INPUT 1 FAIL is flashed on the lower display intermittently every 10 seconds.</p> <p>UPSCALE BURNOUT will make the PV signal increase to full scale when a sensor fails, and flash INPUT 1 FAIL on the lower display intermittently every 10 seconds.</p> <p>The controller remains in Automatic control mode and adjusts the controller output signal in response to the full scale PV signal developed by the Burnout circuitry.</p> <p>DOWNSCALE BURNOUT will make the PV signal decrease to the lower range value when a sensor fails, and flash INPUT 1 FAIL on the lower display intermittently every 10 seconds.</p> <p>The controller remains in Automatic control mode and adjusts the controller output signal in response to the zero percent PV signal developed by the Burnout circuitry.</p> <p>NO FAILSAFE—This selection does not provide input failure detection and should only be used when an absolute accuracy is the most important criteria. (For this selection, no burnout signal is sent to the sensor.)</p> <p>ATTENTION For no Burnout, i.e. NONE, to function properly on a 4-20 mA input, there must be a dropping resistor directly across the <i>input</i> terminals (i.e., not remote), then the unit can detect the “zero” voltage that occurs when the 4-20 mA line is opened.</p>

Lower Display Prompt	Upper Display Range of Setting or Selection	Parameter Definition
EMISSIV1	0.01 to 1.00	EMISSIVITY is a correction factor applied to the Radiamatic input signal that is the ratio of the actual energy emitted from the target to the energy which would be emitted if the target were a perfect radiator. Available only for Radiamatic inputs.

4.9 Input 2 Parameters Set Up Group

Introduction

These are the parameters required for Input 2: actuation, transmitter characterization, high and low range values in engineering units, ratio, bias, filter, burnout, and emissivity.

ATTENTION Prompts for Input 2 appear only if the Input 2 PWA is installed. If the Loop1 Control Algorithm is set for PID A, PID B, or PD+MR and the Loop1 Output Algorithm is set for Position Proportional then the Input 2 configuration prompts are not displayed.

Input 2 group prompts

Table 4-8 lists all the function prompts in the Input 2 Set Up group and their definitions.

Table 4-8 Input 2 Group Definitions

Lower Display Prompt	Upper Display Range of Setting or Selection	Parameter Definition
<p>IN2 TYPE</p> <p>ATTENTION Changing the input type will result in the loss of Field Calibration values and will restore Factory Calibration values.</p>	<p>Same as for Input 1 (except Carbon and Oxygen are not used) <i>plus</i>: SLIDEW*</p>	<p>INPUT 2 ACTUATION TYPE – This selection determines what actuation you are going to use for Input 2.</p> <p>SLIDEWIRE</p> <p>*If the Loop 1 Output Algorithm is set for Position Proportional, then the Input 2 actuation is forced to slidewire (SLIDEW). If Loop 1 Control Algorithm is set for Three Position Step Control, then the SLIDEW setting allows the motor position to be shown on the Lower Display. The SLIDEW setting is not available on two-loop or cascade controllers.</p>
<p>XMITTER2 ANALYTIC IN2 HI IN2 LO RATIO 2 BIAS IN2 FILTER 2 BURNOUT2 EMISSIV2</p>	<p>Input 2 ranges and selections are same as for Input 1.</p>	<p>Refer to Input 1 parameters for definitions.</p>

4.10 Input 3 Parameters Set Up Group

Introduction

These are the parameters required for Input 3: actuation, transmitter characterization, high and low range values in engineering units, ratio, bias, and filter.

ATTENTION Input 3 prompts appear on expanded models only. Prompts for Input 3 only appear if Input 2 PWA is installed and the actuation for Input 2 is configured for one of the following types: 0-5 Vdc, 1-5 Vdc, 0-20 mA, or 4-20 mA.

Input 3 group prompts Table 4-9 lists all the function prompts in the Input 3 Set Up group and their definitions.

Table 4-9 Input 3 Group Definitions

Lower Display Prompt	Upper Display Range of Setting or Selection	Parameter Definition
<p>IN3 TYPE</p> <p>ATTENTION Changing the input type will result in the loss of Field Calibration values and will restore Factory Calibration values.</p>	<p>DISABL 0-20mA 4-20mA 0-5 V 1-5 V</p>	<p>INPUT 3 ACTUATION TYPE – This selection determines what actuation you are going to use for Input 3.</p> <p>DISABL—Disables Input 3 0-20mA—0 to 20 milliamperes 4-20mA—4 to 20 milliamperes 0-5 V—0 to 5 volts 1-5 V—1 to 5 volts</p>
<p>XMITTER2 IN3 HI IN3 LO RATIO 3 BIAS IN3 FILTER 3</p>	<p>Input 3 ranges and selections are same as for Input 1 except Burnout and Emissivity are not available.</p>	<p>Refer to Input 1 parameters for definitions.</p>

4.11 Loop 1 Control Parameters Set Up Group



Introduction

The functions listed in this group deal with how the Single-Loop process controller or Loop 1 of a Two-Loop process controller will control the process including: PV source, Number of tuning parameter sets, Setpoint source, Tracking, Power-up recall, Setpoint limits, Output direction, rate and limits, Power-up preset outputs, Dropoff, Deadband, and Hysteresis.

Control group prompts

Table 4-10 lists all the function prompts in the Control Set Up group and their definitions.

Table 4-10 Control Group Definitions

Lower Display Prompt	Upper Display Range of Setting or Selection	Parameter Definition
PV SOURCE	INP 1 INP 2 IN AL1 IN AL2 INP 3	PROCESS VARIABLE SOURCE —Select the source of the Process Variable. INPUT 1 INPUT 2 INPUT ALGORITHM 1 INPUT ALGORITHM 2 INPUT 3
PID SETS	1 ONLY 2KEYBD	NUMBER OF TUNING PARAMETER SETS —This selection lets you choose one or two sets of tuning constants (gain, rate, and reset). ONE SET ONLY —Only one set of tuning parameters is available. Configure the values for: Gain (proportional band), Rate, Reset Time, and Cycle Time (if time proportional is used). TWO SETS KEYBOARD SELECTABLE —Two sets of tuning parameters can be configured and can be selected at the operator interface or by using the Digital Inputs. Press LOWER DISPLAY key until you see PID SET1 or PID SET2 then press  or  to switch between sets. Configure the values for: Gain, Rate, Reset, Cycle Time Gain #2, Rate #2, Reset #2, Cycle #2 Time <i>See Subsection 5.10 for procedures.</i>

Lower Display Prompt	Upper Display Range of Setting or Selection	Parameter Definition
PID SETS (continued)	2PV SW	<p>TWO SETS PV AUTOMATIC SWITCHOVER—When the process variable is <i>GREATER</i> than the value set at prompt SW VALUE (Switchover Value), the controller will use Gain, Rate, Reset, and Cycle Time. The active PID SET can be read in the lower display.</p> <p>When the process variable is <i>LESS</i> than the value set at prompt SW VALUE, the controller will use Gain #2, Rate #2, Reset #2, and Cycle #2 Time. The active PID SET can be read in the lower display.</p> <p><i>Other prompts affected: SW VALUE</i></p>
	2SP SW	<p>TWO SETS SP AUTOMATIC SWITCHOVER—When the setpoint is <i>GREATER</i> than the value set at prompt SW VALUE (Switchover Value), the controller will use Gain, Rate, Reset, and Cycle.</p> <p>When the setpoint is <i>LESS</i> than the value set at prompt SW VALUE, the controller will use Gain #2, Rate #2, Reset #2, and Cycle #2.</p> <p><i>Other prompts affected: SW VALUE</i></p>
	GAIN S*	<p>GAIN SCHEDULING allows you to schedule eight user-defined Gain segments applied over a user-defined PV range. Enter Gain and PV values under Tuning Set Up prompts. PB or GAIN selection in this group also applies.</p> <p>*Part of Math option DC330E</p> <p>ATTENTION Gain scheduling automatically disables Accutune for this loop.</p>
SW VALUE	Value in engineering units within PV or SP range limits	<p>AUTOMATIC SWITCHOVER VALUE—This is the value of Process Variable or Setpoint at which the controller will switch from Tuning Constant Set #2 to Set #1.</p> <p><i>Only appears when PID SETS selection is configured for either 2 PVSW or 2 SPSW.</i></p>
LSP'S	1 ONLY TWO THREE	<p>LOCAL SETPOINT SOURCE—This selection determines what your local setpoint source will be.</p> <p>LOCAL SETPOINT—The setpoint entered from the keyboard.</p> <p>TWO LOCAL SETPOINTS—This selection lets you switch between two local setpoints using the SETPOINT SELECT key.</p> <p>THREE LOCAL SETPOINTS—This selection lets you switch between three local setpoints using the SETPOINT SELECT key. LSP 3 is mutually exclusive with RSP or Internal Cascade.</p>

Lower Display Prompt	Upper Display Range of Setting or Selection	Parameter Definition
RSP SRC	NONE INP 2 IN AL1 IN AL2 INP 3	<p>REMOTE SETPOINT SOURCE—This selection determines what your remote setpoint source will be when toggled by the SETPOINT SELECT key or Digital Input. Not available for Cascade PID Loop.</p> <p>RSP, Cascade, and SP3 are mutually exclusive.</p> <p>NONE—No remote setpoint. INP 2—Remote Setpoint is Input 2. IN AL1—Remote Setpoint using Input 1 algorithm. IN AL2—Remote Setpoint using Input 2 algorithm. INP 3—Remote Setpoint is Input 3.</p> <p>ATTENTION To cycle through the available local setpoints and remote setpoint, press and hold in the SETPOINT SELECT key. When the key is released, the setpoint selection currently displayed will be the new setpoint selection.</p>
AUTOBIAS	ENABLE DISABL	<p>AUTOBIAS is used for bumpless transfer when transferring from local setpoint to remote setpoint. Auto Bias calculates and adds a bias to remote setpoint input each time a transfer is made.</p> <p>Only available if no tracking is selected.</p> <p>ENABLE—Enables auto bias. DISABLE—Disables auto bias.</p>
SP TRACK	NONE PV RSP	<p>SETPOINT TRACKING—The local setpoint can be configured to track either PV or RSP as listed below. Not configurable when Auto Bias is set.</p> <p>ATTENTION For selections other than NONE, LSP is stored in nonvolatile memory only when there is a mode change; i.e., when switching from RSP to LSP or from Manual to Automatic. If power is lost, then the current LSP value is also lost.</p> <p>NO TRACKING—If local setpoint tracking is not configured, the LSP will not be altered when transfer from RSP to LSP is made.</p> <p>PV—Local setpoint tracks the PV when in manual. RSP—Local setpoint tracks remote setpoint when in automatic. When the controller transfers out of remote setpoint, the last value of the remote setpoint (RSP) is inserted into the local setpoint.</p>
PWR MODE	MANUAL A LSP A RSP	<p>POWER UP CONTROLLER MODE RECALL—This selection determines which mode and setpoint the controller will use when the controller restarts after a power loss. It applies to both loops.</p> <p>MANUAL, LSP—At power-up, the controller will use manual mode with the local setpoint displayed. AUTOMATIC MODE, LAST LSP—At power-up, the controller will use automatic mode with the last local setpoint used before power down displayed. AUTOMATIC MODE, LAST RSP—At power-up, the controller will use automatic mode with the last remote setpoint used before power down displayed.</p>

Lower Display Prompt	Upper Display Range of Setting or Selection	Parameter Definition
	AM SP AM LSP	LAST MODE/LAST SETPOINT used before power down. LAST MODE/LAST LOCAL SETPOINT on power down.
PWR OUT For Three Position Step Control Only (Note 3)	LAST F'SAFE	TPSC (Three-Position Step Control) OUTPUT START-UP MODE —This selection determines what position the motor will be in when powered up or in the failsafe position. LAST OUTPUT —At power-up in automatic mode, the motor position will be the last one prior to power down. When the unit goes into FAILSAFE, it will stay in automatic mode; motor will not be driven to the configured failsafe position. FAILSAFE OUTPUT —At power-up in manual mode, the motor will be driven to either the 0 % or 100 % output position, whichever is selected at prompt FAILSAFE. For Burnout/None, when the unit goes into FAILSAFE, it will go to manual mode; motor will be driven to the configured failsafe position.
SP HiLIM	0 to 100 % of PV span in engineering units	SETPOINT HIGH LIMIT* —This selection prevents the local and remote setpoints from going above the value selected here. The setting must be equal or less than the upper range of the inputs.
SP LoLIM	0 to 100 % of PV span in engineering units	SET POINT LOW LIMIT* —This selection prevents the local and remote setpoints from going below the value selected here. The setting must be equal or greater than the lower range of the inputs.
ACTION	DIRECT REVRSE	CONTROL OUTPUT DIRECTION —Select direct or reverse acting. DIRECT ACTING CONTROL —The controller's output <i>increases</i> as the process variable increases. REVERSE ACTING CONTROL —The controller's output <i>decreases</i> as the process variable increases.
*The local setpoint will automatically adjust itself to be within the setpoint limit range. For example, if SP = 1500 and the SP HiLIM is changed to 1200, the new local setpoint will be 1200.		
OUT RATE	ENABLE DISABL	OUTPUT CHANGE RATE —Enables or disables the Output Change Rate. The maximum rate is set at prompt PCT/M UP or PCT/M DN. Only available for PID-A, PID-B, PD+MR control algorithms. ENABLE —Allows output rate. DISABLE —Disables output rate.
PCT/M UP	0 to 9999 % per minute	OUTPUT RATE UP VALUE —This selection limits the rate at which the output can change upward. Enter a value in percent per minute. Appears only if OUT RATE is enabled. "0" means no output rate applied.
PCT/M DN	0 to 9999 % per minute	OUTPUT RATE DOWN VALUE —This selection limits the rate at which the output can change downward. Enter a value in percent per minute. Appears only if OUT RATE is enabled. "0" means no output rate.
OUTHILIM	–5.0 to 105 % of output	HIGH OUTPUT LIMIT —This is the highest value of output beyond which you do not want the controller automatic output to exceed. Use 0 % to 100 % for digital output type. Use –5 % to 105 % for current position output.

Lower Display Prompt	Upper Display Range of Setting or Selection	Parameter Definition
OUTLoLIM	–5.0 to 105 % of output	LOW OUTPUT LIMIT —This is the lowest value of output below which you do not want the controller automatic output to exceed. Use 0 % to 100 % for digital output type. Use –5 % to 105 % for current position output.
I Hi LIM*	Within the range of the output limits	HIGH RESET LIMIT —This is the highest value of output beyond which you want no reset to occur.
I Lo LIM*	Within the range of the output limits	LOW RESET LIMIT —This is the lowest value of output beyond which you want no reset to occur.
DROPOFF*	–5 to 105 % of output	CONTROLLER DROPOFF VALUE —Output value below which the controller output will drop off to the low output limit value set in prompt OUTLoLIM.
DEADBAND	–5.0 to 25.0 % 0.0 to 25.0 % 0.5 to 5.0 %	DEADBAND is an adjustable gap between the operating ranges of output 1 and output 2 in which neither output operates (positive value) or both outputs operate (negative value). Time Duplex On-Off Duplex Position Proportional and Three Position Step
*Reset limits and Dropoff are not displayed when Three Position Step Control is configured.		
OUT HYST	0.0 to 100.0 % of PV span	HYSTERESIS (OUTPUT RELAY) is an adjustable overlap of the ON/OFF states of each control output. This is the difference between the value of the process variable at which the control outputs energize and the value at which they de-energize. Only applicable for ON/OFF control.
FAILMODE	NO LAT LATCH	FAILSAFE MODE NON LATCHING —Controller stays in last mode that was being used (automatic or manual); output goes to failsafe value. (NOTE 1, NOTE 2) LATCHING —Controller goes to manual mode; output goes to failsafe value. (NOTE 2)
FAILSAFE	0 to 100 %	FAILSAFE OUTPUT VALUE —The value used here will also be the output level when you have Communications SHED set to failsafe or when NO BURNOUT is configured and Input 1 fails. Applies for all output types <i>except</i> 3 Position Step.
	0 PCT 100PCT	THREE POSITION STEP FAILSAFE OUTPUT 0 PCT —Motor goes to closed position. 100PCT —Motor goes to open position.
SW_FAIL	0 OCT 100 PCT	PDMR/Position Proportional motor position when slidewire fails. 0 PCT —Motor goes to closed position. 100PCT —Motor goes to open position. Note: PWR OUT must be configured for FSAF.

Lower Display Prompt	Upper Display Range of Setting or Selection	Parameter Definition
MAN OUT	0 to 100 %	POWER-UP PRESET MANUAL OUTPUT —At power-up, the controller will go to manual and the output to the value set here. (NOTE 1)
AUTO OUT	0 to 100 %	POWER-UP PRESET AUTOMATIC OUTPUT —At power-up, the controller will begin its automatic control at the output value set here. (NOTE 1)
PBorGAIN*	PB PCT GAIN	<p>PROPORTIONAL BAND UNITS—Select one of the following for the Proportional (P) term of the PID algorithm:</p> <p>PROPORTIONAL BAND selects units of percent proportional band for the P term of the PID algorithm. Where: $PB \% = \frac{100 \% FS}{GAIN}$</p> <p>GAIN selects the unitless term of gain for the P term of the PID algorithm. Where: $GAIN = \frac{100 \% FS}{PB\%}$</p>
MINorRPM*	RPM MIN	<p>RESET UNITS—Selects units of minutes per repeat or repeats per minute for the I term of the PID algorithm.</p> <p>20 Repeats per Minute = 0.05 Minutes per Repeat.</p> <p>REPEATS PER MINUTE—The number of times per minute that the proportional action is repeated by reset.</p> <p>MINUTES PER REPEAT—The time between each repeat of the proportional action by reset.</p>
<p>*Selection here is used for both Loop 1 and Loop 2 if available. Also applies to Gain Scheduling on Loops 1 and 2.</p> <p>NOTE 1: Does not apply to Three Position Step Control.</p> <p>NOTE 2: If controller is in Manual upon failure, output will maintain its value at time of failure.</p> <p>NOTE 3: These selections appear when:</p> <ol style="list-style-type: none"> 1. Control Algorithm is selected for 3PSTEP. 2. Control Algorithm is selected for PD+MR and Output Algorithm is selected for Position Proportional. 		

Lower Display Prompt	Upper Display Range of Setting or Selection	Parameter Definition
RSP SRC	NONE INP 2 IN AL1 IN AL2 INP 3	<p>REMOTE SETPOINT SOURCE—This selection determines what your remote setpoint source will be when toggled by the SETPOINT SELECT or Digital Input.</p> <p>NONE—No remote setpoint, INPUT 2—Remote Setpoint is Input 2. INPUT ALGORITHM 1—Remote Setpoint using Input 1 algorithm. INPUT ALGORITHM 2—Remote Setpoint using Input 2 algorithm. INP 3—Remote Setpoint is Input 3.</p> <p>ATTENTION To cycle through the available local setpoints and remote setpoint, press and hold in the [SETPOINT SELECT] key. When the key is released, the setpoint selection currently displayed will be the new setpoint selection.</p>
AUTOBIAS	ENABLE DISABL	<p>AUTO BIAS is used for bumpless transfer when transferring from local setpoint to remote setpoint. Auto Bias calculates and adds a bias to the remote setpoint input each time a transfer is made. Available for any analog input RSP source and if no tracking is selected.</p> <p>ENABLE—Enables auto bias. DISABLE—Disables auto bias.</p>
SPTRACK	NONE PV RSP	<p>SETPOINT TRACKING—The local setpoint can be configured to track either PV or RSP as listed below. Not configurable when Auto Bias is set.</p> <p>ATTENTION For selections other than NONE, LSP is stored in nonvolatile memory only when there is a mode change; i.e., when switching from RSP to LSP or from Manual to Automatic. If power is lost, then the current LSP value is also lost.</p> <p>NO TRACKING—If local setpoint tracking is not configured, the LSP will not be altered when transfer from RSP to LSP is made.</p> <p>PV—Local setpoint tracks the PV when in manual mode.</p> <p>RSP—Local setpoint tracks remote setpoint. When the controller transfers out of remote setpoint, the last value of the remote setpoint (RSP) is inserted into the local setpoint.</p>
SP HiLIM	0 to 100 % of span input in engineering units with decimal place	<p>SETPOINT HIGH LIMIT*—This selection prevents the local and remote setpoints from going above the value selected here. The setting must be equal or less than the upper range of the inputs.</p>
SP LoLIM	0 to 100 % of span input in engineering units with decimal place	<p>SETPOINT LOW LIMIT*—This selection prevents the local and remote setpoints from going below the value selected here. The setting must be equal or greater than the lower range of the inputs.</p>
ACTION	DIRECT	<p>CONTROL OUTPUT DIRECTION—Select direct or reverse acting control.</p> <p>DIRECT ACTING CONTROL—The controller's output <i>increases</i> as the process variable increases.</p>

Lower Display Prompt	Upper Display Range of Setting or Selection	Parameter Definition
	REVRSE	REVERSE ACTING CONTROL —The controller's output <i>decreases</i> as the process variable increases.
OUT RATE	DISABL ENABLE	OUTPUT CHANGE RATE —Enables or disables the Output Change Rate. The maximum rate is set at prompt PCT/M UP or PCT/M DN. DISABLE —Disables output rate. ENABLE —Allows output rate.
PCT/M UP	0 to 9999 % per minute	OUTPUT RATE UP VALUE —This selection limits the rate at which the output can change upward. Enter a value in percent per minute. Appears only if OUT RATE is enabled. "0" means no output rate applied.
PCT/M DN	0 to 9999 % per minute	OUTPUT RATE DOWN VALUE —This selection limits the rate at which the output can change downward. Enter a value in percent per minute. Appears only if OUT RATE is enabled. "0" means no output rate.
OUT HiLIM	–5 to 105 % of output	HIGH OUTPUT LIMIT —This is the highest value of output beyond which you do not want the controller automatic output to exceed. Use 0 to 100 % for digital output type. Use 5 to 105 % for current output.
OUT LoLIM	–5 to 105 % of output	LOW OUTPUT LIMIT —This is the lowest value of output below which you do not want the controller automatic output to exceed. Use 0 % to 100 % for digital output type. Use 5 % to 105 % for current output.
*The Local Setpoint will automatically adjust itself to be within the setpoint limit range. For example, if SP = 1500 and the SP HiLIM is changed to 1200, the new Local Setpoint will be 1200.		
I Hi LIM	Within the range of the output limits	HIGH RESET LIMIT —This is the highest value of output beyond which you want no reset to occur.
I Lo LIM	Within the range of the output limits	LOW RESET LIMIT —This is the lowest value of output beyond which you want no reset to occur.
DROPOFF	–5 to 105 % of output	CONTROLLER DROPOFF VALUE —Output value below which the controller output will drop off to the low output limit value set in prompt OUTLoLIM.
DEADBAND	–5.0 to 5.0 %	DEADBAND is an adjustable gap between the operating ranges of output 1 and output 2 in which neither output operates (positive value) or both outputs operate (negative value).
FAILMODE	NO LAT LATCH	FAILSAFE MODE NON LATCHING —Controller stays in last mode (automatic or manual); output goes to failsafe value. LATCHING —Controller goes to manual mode; output goes to failsafe value.

Lower Display Prompt	Upper Display Range of Setting or Selection	Parameter Definition
FAILSAFE	0 to 100 %	<p>FAILSAFE OUTPUT 2 VALUE—The value used here will also be the output level when you have Communications SHED set to failsafe or when NO BURNOUT is configured and input 1 fails.</p> <p>ATTENTION At power-up, the Loop 2 Output is set to the Failsafe Output 2 value.</p>

4.13 Options Set Up Group

Introduction Configure the remote mode switch (Digital Inputs) to a specific contact closure response, or configure the Auxiliary Output to be a specific selection with desired scaling.

Option group prompts Table 4-12 lists all the function prompts in the Options Set Up group and their functions.

Table 4-12 Options Group Definitions

Lower Display Prompt	Upper Display Range of Setting or Selection	Parameter Definition
<p style="text-align: center;">AUX OUT or CUR OUT2*</p> <p>ATTENTION Prompts for the Auxiliary Output Selection appear only if one of the Auxiliary Output boards is installed.</p> <p>*DE330E only</p>	<p>DISABL</p> <p>INP 1</p> <p>INP 2</p> <p>INP 3</p> <p>CB OUT</p> <p>PV</p>	<p>AUXILIARY OUTPUT SELECTION FOR ONE LOOP or AUXILIARY OUTPUT SELECTION FOR TWO LOOPS</p> <p>This selection provides an mA output representing one of several control parameters. The display for auxiliary output viewing will be in engineering units for all but output. Output will be displayed in percent.</p> <p><i>Other prompts affected by these selections: 4mA VAL and 20mA VAL.</i></p> <p>ATTENTION When the controller is configured for Two-Loop operation, and the Loop 2 Output selection requires a current output, the Auxiliary Output selection is automatically set to Output 2 and all other selections are locked out.</p> <p>ATTENTION Output cannot be configured when Three Position Step Control is used.</p> <p>NO AUXILIARY OUTPUT</p> <p>INPUT 1—This represents the configured range of input 1.</p> <p>FOR EXAMPLE: Type J Thermocouple (0 °F to 1600 °F) 0 °F display = 0 % output 1600 °F display = 100 % output</p> <p>INPUT 2 represents the value of the configured range of input 2.</p> <p>INPUT 3 represents the value of the configured range of input 3.</p> <p>CONTROL BLOCK OUTPUT—Represents the uncharacterized use of automatic control valve which allows the characterizer to characterize the output on Analog Output 1 and the Auxiliary Output to use the uncharacterized output value as Output 2.</p> <p>PROCESS VARIABLE—Represents the value of the Process Variable. $PV = \text{Input XxRatioX} + \text{BiasX}$</p>

Lower Display Prompt	Upper Display Range of Setting or Selection	Parameter Definition
AUX OUT	DEV	<p>DEVIATION (PROCESS VARIABLE MINUS SETPOINT)—Represents –100 % to +100 % of the selected PV span in engineering units.</p> <p>FOR EXAMPLE: Type T Thermocouple PV range = –300 °F to +700 °F PV span = 1000 °F Deviation Range = –1000 °F to +1000 °F If PV = 500 °F and SP = 650 °F then Deviation Display = –150 °F Auxiliary Output = 42.5 %</p> <p>When Deviation is selected, only one operating parameter will be entered. This value represents the deviation level that will produce 20 mA (100 %) output. Zero deviation will produce a center scale (12 mA or 50 %) output. A negative deviation equal in magnitude to the auxiliary output high value will produce a low end (4 mA or 0 %) output.</p>
	OUTPUT	<p>OUTPUT—Represents the displayed controller Loop 1 output in percent (%). Cannot be used with 3 Position Step Control.</p>
	SP	<p>SETPOINT—Represents the Loop1 value of the setpoint in units of PV.</p>
	LSP 1	<p>LOCAL SETPOINT ONE—Auxiliary output represents Loop1 local setpoint one regardless of active setpoint.</p>
	IN AL1	<p>INPUT ALGORITHM 1 OUTPUT—Represents the output from input algorithm 1.</p>
	IN AL2	<p>INPUT ALGORITHM 2 OUTPUT—Represents the output from input algorithm 2.</p>
	PV2	<p>PROCESS VARIABLE 2—Represents the value of the Process Variable for Loop 2.</p>
	DEV 2	<p>DEVIATION 2 (PROCESS VARIABLE MINUS SETPOINT)—Represents –100 % to +100 % of the selected PV span in engineering units for Loop 2.</p> <p>When Deviation is selected, only one operating parameter will be entered. This value represents the deviation level that will produce 20 mA (100 %) output. Zero deviation will produce a center scale (12 mA or 50 %) output. A negative deviation equal in magnitude to the auxiliary output high value will produce a low end (4 mA or 0 %) output.</p>
	OUTPT2	<p>OUTPUT 2—Represents the displayed controller output in percent (%) for Loop 2.</p>
	SP L2	<p>SETPOINT 2—Represents the value of the setpoint in units of PV for Loop 2.</p>
	LSP1 2	<p>LOCAL SETPOINT 2—Represents the value of local setpoint #1 in units of PV for Loop 2.</p>

Lower Display Prompt	Upper Display Range of Setting or Selection	Parameter Definition
AUX OUT (continued)	CB OUT2	CONTROL BLOCK OUTPUT2 —Represents the uncharacterized use of automatic control valve which allows the characterizer to characterize the output on Analog Output 1 and the Auxiliary Output to use the uncharacterized output value as Output 2.
4mA VAL*	Low Scale Value within the range of the selected variable to represent 4 mA	AUXILIARY OUTPUT LOW SCALING FACTOR —Use a value in engineering units to represent all AUX OUT parameters except output. Use value in percent (%) for output. (Output can be between –5 % and +105 %.)
20mA VAL*	High Scale Value within the range of the selected variable to represent 20 mA	AUXILIARY OUTPUT HIGH SCALING FACTOR —Use a value in engineering units to represent all AUX OUT parameters except output. Use a value in percent (%) for Output. (Output can be between –5 % and +105 %.)
*When Deviation is selected, only one operating parameter will be entered. This value represents the deviation level that will produce 20 mA (100 %) output. Zero deviation will produce a center scale (12 mA or 50 %) output. A negative deviation equal in magnitude to the auxiliary output high value will produce a low end (4 mA or 0 %) output.		
DIG IN 1	NONE TO MAN TO LSP TO 2SP TO 3SP TO DIR	DIGITAL INPUT 1 SELECTIONS —All selections are available for Input 1. The controller returns to its original state when contact opens, except when overruled by the keyboard. ATTENTION When the controller is configured for either Cascade or Two-Loop control, then digital input #1 operates only on Loop 1 and digital input #2 operates only on Loop 2. NO DIGITAL INPUT SELECTIONS TO MANUAL —Contact closure puts the affected loop into manual mode. Contact open returns controller to former mode. TO LOCAL SETPOINT —When a remote setpoint is configured, contact closure puts the controller into local setpoint 1. When contact opens, the controller returns to former operation—local or remote setpoint—unless SETPOINT SELECT key is pressed while digital input is active. If this happens, the controller will stay in the local setpoint mode when contact opens. TO LOCAL SETPOINT TWO —Contact closure puts the controller into local setpoint 2. TO LOCAL SETPOINT THREE —Contact closure puts the controller into local setpoint 3. TO DIRECT ACTION —Contact closure selects direct controller action.

Lower Display Prompt	Upper Display Range of Setting or Selection	Parameter Definition
DIG IN 1 (continued)	ToHOLD	<p>TO HOLD—Contact closure suspends Setpoint Program or Setpoint Ramp. When contact reopens, the controller starts from the Hold point of the Ramp/Program unless the Ramp/Program was not previously started via the RUN/HOLD key.</p> <p>This selection applies to either loop.</p>
	ToPID2	<p>TO PID2—Contact closure selects PID Set 2.</p>
	PV 2IN	<p>PV=INPUT 2—Contact closure selects PV = Input 2.</p>
	PV 3IN	<p>PV=INPUT 3—Contact closure selects PV = Input 3.</p>
	RERUN	<p>RERUN--Allows the Setpoint Programmer to be reset to the initial segment of its current cycle , unit stays in previous mode.</p>
	TO RUN	<p>RUN—Contact closure starts a stopped SP Ramp or Program. Upper left character blinks "R". Reopening the contact puts controller in HOLD mode.</p> <p>This selection applies to either loop.</p>
	ToBEGN	<p>EXTERNAL SP PROGRAM RESET—Contact closure resets SP Program back to the beginning of the first segment in the program and places the program in the HOLD mode. Program cycle number is not affected. Reopening switch has no effect.</p> <p>This selection applies to either loop.</p> <p>ATTENTION Once the last segment of the setpoint program has timed out, the controller enters the mode of action specified in the configuration data and the program cannot be reset to the beginning of the first segment by digital input closure.</p>
	STOP I	<p>INHIBIT INTEGRAL (RESET)—Contact closure disables PID Integral (Reset) action.</p>
	MAN FS	<p>MANUAL FAILSAFE OUTPUT—Controller goes to Manual mode, output goes to the Failsafe value.</p> <p>ATTENTION This will cause a bump in the output when switching from Automatic to Manual. The switch back from Manual to Automatic is bumpless. When the switch is closed, the output can be adjusted from the keyboard.</p>
	ToLOCK	<p>KEYBOARD LOCKOUT—Contact closure disables all keys. Lower display shows LOCKED if a key is pressed.</p>
	ToAout	<p>AUTOMATIC OUTPUT—Contact closure sends output to the value set at Control prompt AUTO OUT when the controller is in the Automatic mode. Reopening the contact returns the controller to the normal output. (NOTE 1)</p> <p>This selection is only available on Loop 1.</p>
TIMER	<p>TIMER—Contact closure starts timer, if enabled. Reopening the switch has no effect.</p>	

Lower Display Prompt	Upper Display Range of Setting or Selection	Parameter Definition
DIG IN 1 (continued)	AM STA	<p>TO AUTO/MANUAL STATION—Contact closure causes the loop to perform as follows: PV = Input 2 Action = Direct Control algorithm = PD+MR PID SET = 2 SP = LSP 2</p> <p>This selection is only available on Loop 1.</p>
	ToTUNE	<p>INITIATE LIMIT CYCLE TUNING—Contact closure starts the tuning process. The lower display shows TUNE ON. Opening the contact has no effect.</p>
	SPinit	<p>SETPOINT INITIALIZATION—Contact closure forces the setpoint to the current PV value. Opening the contact has no effect.</p>
	TRACK1	<p>OUTPUT 1 TRACKS INPUT 2*—Contact closure allows Output 1 to track Input 2. (NOTE 1)</p>
	TRACK2	<p>OUTPUT 2 TRACKS INPUT 2*—Contact closure allows Output 2 to track Input 2.</p>
	ToOUT2	<p>OUTPUT 2 OVERRIDES OUTPUT 1—Contact closure allows physical Output 1 to be a copy of Output 2. When contact is released, Loop 1 output will switch back to normal PID controller action starting with the last output value. (NOTE 1)</p>
	TO RSP	<p>TO REMOTE SETPOINT—Contact closure selects the Remote setpoint.</p>
	RST FB	<p>EXTERNAL RESET FEEDBACK—Contact closure allows Input 2 to override the internal reset value.</p>
	ToPURG	<p>TO PURGE—Contact closure forces the loop to Manual mode with the output set to the Output High Limit configuration. MAN lights and the Output value is shown on the lower display. Opening the switch has no effect. (NOTE 1)</p>
	LoFIRE	<p>LOW FIRE—Contact closure forces the loop to Manual mode with the output set to the Output Low Limit configuration. MAN lights and the Output value is shown on the lower display. Opening the switch has no effect. (NOTE 1)</p>
	MAN LT	<p>MANUAL LATCHING—Contact closure transition forces the loop to Manual mode. Opening the switch has no effect. If the MANUAL/AUTO key is pressed while the switch is closed, the loop will return to Automatic mode.</p>
	REStot	<p>RESET TOTALIZER—Contact closure transition resets the accumulated totalizer value. Opening the switch has no effect.</p>

Lower Display Prompt	Upper Display Range of Setting or Selection	Parameter Definition
DIG IN 1 (continued)	HealthWatch option prompts: RESETT1 RESETT2 RESETT3 R ALL T RESETC1 RESETC2 RESETC3 R ALL C RALLTC	TIMER 1 will be reset when contact closes. TIMER 2 will be reset when contact closes. TIMER 3 will be reset when contact closes. ALL TIMERS will be reset when contact closes. COUNTER 1 will be reset when contact closes. COUNTER 2 will be reset when contact closes. COUNTER 3 will be reset when contact closes. ALL COUNTERS will be reset when contact closes. ALL TIMERS AND COUNTERS will be reset when contact closes.
DIG 1 COM	DISABL +PID2 +ToDIR +ToSP2 +DISAT +ToSP1 +RUN	DIGITAL INPUT 1 COMBINATION SELECTIONS — All selections are available in combination with Input 1. DISABLE —Disables combination function. Any Digital Input Selection PLUS PID2 —Contact closure selects PID Set 2. Any Digital Input Selection PLUS DIRECT ACTION —Contact closure selects direct controller action. Any Digital Input Selection PLUS SETPOINT 2 —Contact closure puts the controller into setpoint 2. Any Digital Input Selection PLUS DISABLE ADAPTIVE TUNE —Contact closure disables Accutune process on Loop 1. Any Digital Input Selection PLUS SETPOINT 1 —Contact closure puts the controller into setpoint 1. Any Digital Input Selection PLUS RUN SETPOINT PROGRAM/RAMP —Contact closure starts SP Program/Ramp if enabled.
DIG IN 2	Same selections as for Digital Input 1	DIGITAL INPUT 2 SELECTIONS
DIG2 COM	Same selections as Digital Input 1 Combinations	DIGITAL INPUT 2 COMBINATIONS
*For the Output Tracking selections, when the switch is open, the output is in accordance with its pre-defined functionality. When the switch is closed, the output value (in percent) will track the Input 2 percent of range value. When the switch is reopened, the output will start at this last output value and normal PID action will then take over control. The transfer is bumpless.		

NOTE 1: Does not apply to Three Position Step Control.

4.14 Communications Set Up Group

Introduction

This option allows the controller to be connected to a host computer via RS-422/485 or Modbus protocol.

The controller looks for messages from the computer at regular intervals. If these messages are not received within the configured shed time, the controller will SHED from the communications link and return to stand-alone operation. Depending on the protocol selected, the device address, parity, and baud rate are configurable. You can also set the SHED output mode and setpoint recall, and communication units.

Up to 99 addresses can be configured over this link. The number of units that can be configured depends on the protocol chosen:

- RS-422/485—15 drops maximum
- Modbus—15 drops (or 31 for shorter link length) maximum

Communications group prompts

Table 4-13 lists all the function prompts in the Communications Set Up group and their definitions.

Table 4-13 Communications Group Definitions

Lower Display Prompt	Upper Display Range of Setting or Selection	Parameter Definition
ComSTATE	DISABL MOD3K MODBUS RS422	COMMUNICATIONS SELECTION DISABLE —Disables the communications option. MB3K —Allows the UDC3300 to emulate the UDC3000A Modbus protocol. MODBUS —Allows Modbus RTU communication prompts. RS-422/485 —Allows RS422/485 ASCII communication prompts.
Com ADDR	1 to 99	COMMUNICATIONS STATION ADDRESS (LOOP 1) — This is a number that is assigned to a controller that is to be used with the communications option. This number will be its address.
ComADDR2	1 to 99	COMMUNICATIONS STATION ADDRESS (LOOP 2) — This is a number that is assigned to a controller that is to be used with the communications option. This number will be its address. When ComSTATE = MODBUS, ComADDR2 = Com ADDR. ATTENTION If RS-422/485 addresses on both loops are the same, then only Loop 1 will respond.
SHED ENAB	DISABL ENABLE	SHED ENABLE —Disables/enables shed functionality. Applies to Modbus protocol only.

Lower Display Prompt	Upper Display Range of Setting or Selection	Parameter Definition																														
SHEDTIME	0 to 255	<p>SHED TIME—The number that represents how many sample periods there will be before the controller sheds from communications. Each period equals 1/3 seconds; 0 equals No shed.</p> <p>Note: If ComSTATE is set to MODBUS or MB3K and if SHEDENAB is set to DISABL, Shed Time will not be configurable.</p>																														
PARITY	ODD EVEN	<p>PARITY pertains to the use of a self-checking code employing binary digits in which the total number of ONE's (or ZERO's) in each permissible code expression is either ODD or EVEN.</p> <p>Fixed at NONE when ComSTATE = MODBUS ODD PARITY EVEN PARITY</p>																														
BAUD	2400 4800 9600 19200	<p>BAUD RATE is the transmission speed in bits per second.</p> <p>2400 BAUD 4800 BAUD 9600 BAUD 19200 BAUD</p>																														
DUPLEX (RS422/485 ASCII only)	HALF FULL	<p>DUPLEX—Transmission Type</p> <p>HALF DUPLEX—Two wires FULL DUPLEX—Four wires</p> <p>ATTENTION</p> <ul style="list-style-type: none"> When the Auxiliary Output/RS422/485 Option board is installed, this selection is fixed at HALF. 																														
WS_FLOAT	FP_B FP_BB FP_L FP_LB	<p>Defines word/byte order of floating point data for communications.</p> <table border="0" data-bbox="787 1249 1388 1438"> <tr> <td></td> <td>0</td> <td>1</td> <td>2</td> <td>3</td> </tr> <tr> <td>seeeeeee</td> <td>emmmmmmm</td> <td>mmmmmmmm</td> <td>mmmmmmmm</td> <td>mmmmmmmm</td> </tr> <tr> <td>FP_B</td> <td>0</td> <td>1</td> <td>2</td> <td>3</td> </tr> <tr> <td>FP_BB</td> <td>1</td> <td>0</td> <td>3</td> <td>2</td> </tr> <tr> <td>FP_L</td> <td>3</td> <td>2</td> <td>1</td> <td>0</td> </tr> <tr> <td>FP_LB</td> <td>2</td> <td>3</td> <td>0</td> <td>1</td> </tr> </table>		0	1	2	3	seeeeeee	emmmmmmm	mmmmmmmm	mmmmmmmm	mmmmmmmm	FP_B	0	1	2	3	FP_BB	1	0	3	2	FP_L	3	2	1	0	FP_LB	2	3	0	1
	0	1	2	3																												
seeeeeee	emmmmmmm	mmmmmmmm	mmmmmmmm	mmmmmmmm																												
FP_B	0	1	2	3																												
FP_BB	1	0	3	2																												
FP_L	3	2	1	0																												
FP_LB	2	3	0	1																												
TX DELAY	1 to 500 milliseconds	<p>TX DELAY—Configurable response-delay timer allows you to force the UDC to delay its response for a time period of from 1 to 500 milliseconds compatible with the host system hardware/software.</p>																														

Lower Display Prompt	Upper Display Range of Setting or Selection	Parameter Definition
SHEDMODE	<p>LAST</p> <p>TOAUTO</p> <p>FSAFE</p> <p>To MAN</p>	<p>SHED CONTROLLER MODE AND OUTPUT LEVEL—Determines the mode of local control you want when the controller is shed from the communications link.</p> <p>Note: If COMSTATE = MODBUS or MB3K and if SHEDENAB=DISABLE, this prompt will not be configurable.</p> <p>LAST—SAME MODE AND OUTPUT—The controller will return to the same mode (manual or automatic) at the same output level that it had before shed.</p> <p>ToAUTO—AUTOMATIC MODE, LAST SP—The controller will return to the automatic mode and the last setpoint used before shed.</p> <p>FSAFE—MANUAL MODE, FAILSAFE OUTPUT—The controller will return to manual mode at the output value selected at Control prompt FAILSAFE.</p> <p>To MAN—MANUAL MODE, SAME OUTPUT—The controller will return to manual mode at the same output level that it had before shed.</p>
SHED SP	<p>TO LSP</p> <p>TO CSP</p>	<p>SHED SETPOINT RECALL</p> <p>Note: If COMSTATE = MODBUS or MOD3K and if SHEDENAB=DISABLE, this prompt will not be configurable.</p> <p>TO LSP—Controller will use last local or remote setpoint used.</p> <p>TO CSP—When in “slave” mode, the controller will store the last host computer setpoint and use it at the Local setpoint. When in “monitor” mode, the controller will shed to the last UDC Local or Remote setpoint used, and the LSP is unchanged.</p>
<p>UNITS (RS422/485 ASCII only)</p>	<p>PERCNT</p> <p>ENG</p>	<p>COMMUNICATION UNITS—This selection determines how the controller values are expressed (on both loops) during communications.</p> <p>PERCENT OF SPAN</p> <p>ENGINEERING UNITS</p>
CSP RATO	-20.0 to 20.0	LOOP 1 COMPUTER SETPOINT RATIO —Computer setpoint ratio for Loop 1.
CSP BIAS	-999. to 9999. (engineering units)	LOOP 1 COMPUTER SETPOINT BIAS —Computer setpoint bias for Loop 1.
CSP2RATO	-20.0 to 20.0	LOOP 2 COMPUTER SETPOINT RATIO —Computer setpoint ratio for Loop 2.
CSP2BIAS	-999. to 9999 (engineering units)	LOOP 2 COMPUTER SETPOINT BIAS —Computer setpoint bias for Loop 2.

Lower Display Prompt	Upper Display Range of Setting or Selection	Parameter Definition
<p>LOOPBACK</p>	<p>DISABL ENABLE</p>	<p>LOCAL LOOPBACK tests the communications hardware.</p> <p>DISABLE—Disables the Loopback test.</p> <p>ENABLE—Allows loopback test. The UDC goes into Loopback mode in which it sends and receives its own message. The UDC displays PASS or FAIL status in the upper display and LOOPBACK in the lower display while the test is running. The UDC will go into manual mode. The test will run until the operator disables it here, or until power is turned off and on.</p> <p>ATTENTION The UDC does not have to be connected to the RS-485 link to perform this test. If it is connected, only one UDC 3300 should run the loopback test at a time. The computer should not be transmitting on the link while the loopback test is active.</p>

4.15 Alarms Set Up Group

Introduction

An alarm is an indication that an event that you have configured (for example—Process Variable) has exceeded one or more alarm limits. There are two alarms available. Each alarm has two setpoints. You can configure each of these two setpoints to alarm on various controller parameters.

There are two alarm output selections, High and Low. You can configure each setpoint to alarm either High or Low. These are called single alarms.

You can also configure the two setpoints to alarm on the same event and to alarm both high and low. A single adjustable Hysteresis of 0 % to 100 % is configurable for the alarm setpoint.

See Table 2-8 in the Installation section for Alarm relay contact information.

The prompts for the Alarm Outputs appear whether or not the alarm relays are physically present. This allows the Alarm status to be shown on the display and/or sent via communications to a host computer.

Alarms group prompts

Table 4-14 lists all the function prompts in the Alarms Set Up group and their definitions.

Table 4-14 Alarms Group Definitions

Lower Display Prompt	Upper Display Range of Setting or Selection	Parameter Definition
A1S1 VAL*	Value in engineering units	<p>ALARM 1 SETPOINT 1 VALUE—This is the value at which you want the alarm type chosen in prompt A1S1TYPE to actuate. The value depends on what the setpoint has been configured to represent. NO setpoint is required for Communications SHED. For SP Programming the value is the segment number for which the event applies.</p> <p>For Maintenance Timers, the setpoint value is HOURS.TENTHS OF HOURS. Example: setpoint value 4.2 means 4 hours 12 minutes. (Be aware that the value of the Timer itself is displayed in HOURS.MINUTES. Example: 4.2 means 4 hours 2 minutes.)</p> <p>For Maintenance Counters for output relays 1 and 2, the setpoint value is in thousands of counts (1 = 1000 counts).</p> <p>This prompt does not appear for “Alarm on Manual” type alarm. For example: A1S1TYPE = MANUAL.</p>
A1S2 VAL*	Value in engineering units	<p>ALARM 1 SETPOINT 2 VALUE—This is the value at which you want the alarm type chosen in prompt A1S2TYPE to actuate.</p> <p>The details are the same as A1S1 VAL.</p>
A2S1 VAL*	Value in engineering units	<p>ALARM 2 SETPOINT 1 VALUE—This is the value at which you want the alarm type chosen in prompt A2S1TYPE to actuate.</p> <p>The details are the same as A1S1 VAL.</p>

Lower Display Prompt	Upper Display Range of Setting or Selection	Parameter Definition
A2S2 VAL*	Value in engineering units	<p>ALARM 2 SETPOINT 2 VALUE—This is the value at which you want the alarm type chosen in prompt A2S2TYPE to actuate.</p> <p>The details are the same as A1S1 VAL.</p>
<p>*When the associated type is configured for Alarm on Totalizer Value, the Alarm SP value represents the four lowest digits for the selected Totalizer Scale Factor. When the Totalizer value exceeds the Alarm SP, the alarm is activated. The range is 0 to 9999 x Totalizer Scale Factor.</p>		
<p>*When the associated type is configured for a HealthWatch Maintenance Timer, the Alarm SP represents number of hours.</p>		
A1S1TYPE	<p>NONE INP 1 INP 2 INP 3 PV DEV OUTPUT SHED EV ON EV OFF MANUAL REM SP F SAFE PVRATE PV 2 DEV 2 OUT 2 MAN 2 RSP 2 F SAF2 PVRAT2 BREAK BREAK2 TOTAL TIMER1 TIMER2 TIMER3 COUNT1 COUNT2 COUNT3</p>	<p>ALARM 1 SETPOINT 1 TYPE—Select what you want Setpoint 1 of Alarm 1 to represent. It can represent the Process Variable, Deviation, Input 1, Input 2, Output, and if you have a model with communications, you can configure the controller to alarm on SHED. If you have setpoint programming, you can alarm when a segment goes ON or OFF.</p> <p>NO ALARM INPUT 1 INPUT 2 INPUT 3 PROCESS VARIABLE (Loop 1) DEVIATION (Loop 1) OUTPUT (Loop 1) (NOTE 1) SHED FROM COMMUNICATIONS (Both Loops) EVENT ON (SP PROGRAMMING) EVENT OFF (SP PROGRAMMING) ALARM ON MANUAL MODE (Loop 1) (NOTE 2) REMOTE SETPOINT FAILSAFE PV RATE OF CHANGE (Loop 1) PROCESS VARIABLE (Loop 2) DEVIATION (Loop 2) OUTPUT (Loop 2) (NOTE 1) ALARM ON MANUAL MODE (Loop 2) (NOTE 2) REMOTE SETPOINT (Loop 2) FAILSAFE (Loop 2) PV RATE OF CHANGE (Loop 2) LOOP BREAK (Loop 1) (NOTE 3) LOOP BREAK (Loop 2) (NOTE 3) ALARM ON TOTALIZER VALUE HEALTHWATCH MAINTENANCE TIMER 1 VALUE HEALTHWATCH MAINTENANCE TIMER 2 VALUE HEALTHWATCH MAINTENANCE TIMER 3 VALUE HEALTHWATCH MAINTENANCE COUNTER 1 VALUE HEALTHWATCH MAINTENANCE COUNTER 2 VALUE HEALTHWATCH MAINTENANCE COUNTER 3 VALUE</p> <p>ATTENTION</p> <p>NOTE 1. When the controller is configured for Three Position Step Control, alarms set for Output will not function.</p> <p>NOTE 2. Not available if Timer is enabled because Alarm 1 is dedicated to Timer output.</p> <p>NOTE 3. When enabled, the control output is checked for minimum and maximum limits. When this occurs, a timer begins and, if the output has not caused the PV to be corrected by a pre-determined amount and time, the alarm activates. For loop break alarms, the timer value may be changed only for loops configured for On-Off control.</p>

Lower Display Prompt	Upper Display Range of Setting or Selection	Parameter Definition
AL HYST	0.0 to 100.0 % of span or full output as appropriate	<p>ALARM HYSTERESIS—A single adjustable hysteresis is provided on alarms such that when the alarm is OFF it activates at exactly the alarm setpoint; when the alarm is ON, it will not deactivate until the variable is 0.0 % to 100 % away from the alarm setpoint.</p> <p>Configure the hysteresis of the alarms based on INPUT signals as a % of input range span.</p> <p>Configure the hysteresis of the alarm based on OUTPUT signals as a % of the full scale output range.</p>
ALM OUT1	NO LAT LATCH	<p>LATCHING ALARM FOR OUTPUT 1—Each alarm output can be configured to be Latching or Non-latching.</p> <p>NO LAT—Non-latching LATCH—Latching</p> <p>ATTENTION When configured for latching, the alarm will stay on, after the alarm condition ends, until the RUN/HOLD key is pressed.</p>
BLOCK	DISABL BLOCK1 BLOCK2 BLK 12	<p>ALARM BLOCKING—Prevents nuisance alarms when the controller is first powered up. The alarm is suppressed until the parameter gets to the non-alarm limit or band. Alarm blocking affects both alarm setpoints.</p> <p>DISABL—Disables blocking BLOCK1—Blocks alarm 1 only BLOCK2—Blocks alarm 2 only BLK 12—Blocks both alarms</p> <p>ATTENTION When enabled on power up or initial enabling via configuration, the alarm will not activate unless it has not been in alarm for one cycle (167 ms).</p>

How to configure alarm to turn on and off with HealthWatch

Configure Alarm n Setpoint 1 Value as the turn-on time or count, that is, the alarm turns on when the timer or counter reaches this value.

Configure Alarm n Setpoint 2 Value as the turn-off time or count, that is, the alarm turns off after being on for this much time or this many counts. When the setpoint is reached it resets any HealthWatch timer or counter associated with Alarm1 Setpoint1 or 2 and Alarm 2.

Example

To turn on Alarm 1 after 30 days for 2 minutes.

1. Under Alarms group, configure A1S1TYPE as TIMER1. Configure A1S1 VAL as 720 hours (30 days x 24 hours). Configure A1S2 VAL as 0.033 hours (2 minutes/60 minutes because setpoint units are in hours).
2. Under Maintenance group, configure TIME1 as LAST R (time since last reset). Configure TIME2 as AL1SP1.

4.16 Display Parameters Set Up Group

Introduction This group includes selections for Decimal place, Units of temperature, and Power frequency.

Display group prompts Table 4-15 lists all the function prompts in the Display Set Up group and their definitions.

Table 4-15 Display Group Definitions

Lower Display Prompt	Upper Display Range of Setting or Selection	Parameter Definition
DECIMAL	XXXX XXX.X XX.XX X.XXX	<p>DECIMAL POINT LOCATION FOR LOOP 1—This selection determines where the decimal point appears in the display.</p> <p>XXXX—No Decimal Place—fixed, no auto-ranging XXX.X—One Place XX.XX—Two Places X.XXX—Three Places</p> <p>ATTENTION Auto-ranging will occur for selections of one, two, or three places.</p>
DECIMAL2	XXXX XXX.X XX.XX X.XXX	<p>DECIMAL POINT LOCATION FOR LOOP 2—This selection determines where the decimal point appears in the display for Loop 2.</p> <p>XXXX—No Decimal Place—fixed, no auto-ranging XXX.X—One Place XX.XX—Two Places X.XXX—Three Places</p> <p>ATTENTION Auto-ranging will occur for selections of one, two, or three places.</p>
TEMP UNIT	DEG F DEG C NONE	<p>TEMPERATURE UNITS FOR BOTH LOOPS—This selection will affect the indication and operation.</p> <p>DEG F—Degrees Fahrenheit DEG C—Degrees Centigrade NONE—No display of units</p>
PWR FREQ	60 HZ 50 HZ	<p>POWER LINE FREQUENCY—Select whether your controller is operating at 50 or 60 Hertz.</p> <p>ATTENTION For controllers powered by +24 Vdc, this configuration should be set to the AC line frequency used to produce the +24 Vdc supply.</p> <p>Incorrect setting of this parameter can cause normal mode noise problems in the input readings.</p>
RATIO 2	DISABL ENABLE	<p>INPUT 2 RATIO—This enables the Ratio for Input 2 to be set from the front panel. Input 2 must be installed and enabled for this configuration to operate.</p> <p>DISABLE—Disables setting Ratio 2 from front panel. ENABLE—Allows the Ratio for Input 2 to be set through the keyboard.</p>

Lower Display Prompt	Upper Display Range of Setting or Selection	Parameter Definition
LANGUAGE	ENGLIS FRENCH GERMAN SPANIS ITALAN	LANGUAGE —This selection designates the prompt language. ENGLISH FRENCH GERMAN SPANISH ITALIAN

4.17 Calibration Data

Introduction The prompts used here are for field calibration purposes. Refer to *Section 6 – Input Calibration* in this manual for complete information.

4.18 Maintenance Group

Introduction The Maintenance group prompts are part of the HealthWatch feature. These prompts let you count and time the activity of discrete events such as relays, alarms, control modes and others, to keep track of maintenance needs.

Maintenance group prompts Table 4-16 lists all the function prompts in the Maintenance Set Up group.

Table 4-16 Maintenance Group Definitions

Lower Display Prompt	Upper Display Range of Setting or Selection	Parameter Definition
TIME1	DISABL LASTR AL1SP1 AL1SP2 AL2SP1 AL2SP2 MANUAL	TIMER 1 —The timer tracks the elapsed time of the selected event. DISABL —Disables the timer. LAST RESET —Time elapsed since the last reset. ALARM 1 SETPOINT 1 —Cumulative time Alarm 1 Setpoint 1 was activated. ALARM 1 SETPOINT 2 — Cumulative time Alarm 1 Setpoint 2 was activated. ALARM 2 SETPOINT 1 — Cumulative time Alarm 2 Setpoint 1 was activated. ALARM 2 SETPOINT 2 — Cumulative time Alarm 2 Setpoint 2 was activated. LOOP 1 MANUAL —Cumulative time Loop 1 was in Manual.

Lower Display Prompt	Upper Display Range of Setting or Selection	Parameter Definition
TIME1 (continued)	GSOAK SOOTNG DIGIN1 DIGIN2 MAN2	GUARANTEED SOAK — Cumulative time the process was outside the guaranteed soak band. SOOTING — Cumulative time process was in sooting state DIGITAL INPUT1 — Cumulative time Digital Input 1 was closed DIGITAL INPUT 2 — Cumulative time Digital Input 2 was closed LOOP 2 MANUAL — Cumulative time Loop 2 was in Manual.
HRS.MIN1 OR DAYS.HRS1	00.00 to 23.59 1.00 to 416.15	Shows elapsed time of Timer 1 in Hours and Minutes. At 24.00, units change automatically to Days and Hours.
TIME 2	Same as TIME 1	The timer tracks the elapsed time of the selected event.
HRS.MIN2 OR DAYS.HRS2	00.00 to 23.59 1.00 to 416.15	Shows elapsed time of Timer 2 in Hours and Minutes. At 24.00, units change automatically to Days and Hours.
TIME 3	Same as TIME 1	The timer tracks the elapsed time of the selected event.
HRS.MIN3 OR DAYS.HRS3	00.00 to 23.59 1.00 to 416.15	Shows elapsed time of Timer 3 in Hours and Minutes. At 24.00, units change automatically to Days and Hours.
COUNTER1	DISABL MANUAL AL1SP1 AL1SP2 AL2SP1 AL2SP2 DIGIN1 DIGIN2 OUT1*1K OUT2*1K GSOAK PWRCYC PV_RNG FAILSF TUNE MAN2 PVRNG2	COUNTER 1 —The counter counts the number of times the selected event has occurred. DISABLE —Counter is not in use. LOOP 1 MANUAL —Number of times Loop 1 has been in Manual mode. ALARM 1 SETPOINT 1 —Number of times Alarm 1 Setpoint 1 has been activated. ALARM 1 SETPOINT 2 —Number of times Alarm 1 Setpoint 2 has been activated. ALARM 2 SETPOINT 1 —Number of times Alarm 2 Setpoint 1 has been activated. ALARM 2 SETPOINT 2 —Number of times Alarm 2 Setpoint 2 has been activated. DIGITAL INPUT 1 —Number of times Digital Input 1 has closed. DIGITAL INPUT 2 —Number of times Digital Input 2 has closed. OUTPUT 1 RELAY x 1000 —Thousands of times Output 1 relay has been activated. OUTPUT 2 RELAY x 1000 —Thousands of times Output 2 relay has been activated. GUARANTEED SOAK —Number of times unit has been in guaranteed soak. POWER CYCLE —Number of times unit's power has cycled off and on. LOOP 1 PV RANGE —Number of times Loop 1's PV has been out of range. LOOP 1 FAILSAFE —Number of times Loop 1 has been in Failsafe mode. LOOP 1 TUNE —Number of times Loop 1 has been tuned (manually and automatically) LOOP 2 MANUAL —Number of times Loop 2 has been in Manual mode. LOOP 2 PV RANGE —Number of times Loop 2's PV has been out of range.
COUNTER 1	FSF2	LOOP 2 FAILSAFE —Number of times Loop 2 has been in

Lower Display Prompt	Upper Display Range of Setting or Selection	Parameter Definition
(continued)	TUNE2	Failsafe mode. LOOP 2 TUNE —Number of times Loop 2 has been tuned (manually and automatically).
COUNTS1	0-9999 (1 = 1000 counts for output relays 1 and 2)	Shows the value of Counter 1. Read only.
COUNTER2	Same as COUNTER1	Counter 2 counts the number of times the selected event has occurred.
COUNTS2	Same as COUNTS1	Shows the value of Counter 2. Read only.
COUNTER3	Same as COUNTER1	Counter 3 counts the number of times the selected event has occurred.
COUNTS3	Same as COUNTS1	Shows the value of Counter 3. Read only.
PASSWORD	0-9999	PASSWORD —Entering the designated number resets to zero the timer or counter specified by Reset Type. To designate a number as the password: 1. Set all timers and counters to DISABL. 2. Enter the desired PASSWORD (0-9999). 3. Select a Reset Type (next prompt). The PASSWORD goes into effect when you press FUNC , that is, you can use it to reset the counters and timers.
RES TYPE	NONE TIMER1 TIMER2 TIMER3 ALL TM COUNT1 COUNT2 COUNT3 ALL CO ALL TC	RESET TYPE —Select which timers and/or counters will be reset to zero when the PASSWORD is entered. NONE —No values will be reset TIMER 1 will be reset TIMER 2 will be reset TIMER 3 will be reset ALL TIMERS will be reset COUNTER 1 will be reset COUNTER 2 will be reset COUNTER 3 will be reset ALL COUNTERS will be reset ALL TIMERS AND COUNTERS will be reset

4.19 Status Test Data

Introduction

The prompts used here are for determining the reason for a controller failure. Refer to the *Section 8 – Troubleshooting* in this manual for complete information.

Section 5 – Operation

5.1 Overview

Introduction

This section gives you all the information necessary to monitor and operate your controller. Review the Operator Interface shown in “Monitoring” to make sure you are familiar with the indicator definitions. The key functions are listed in *Section 1 – Overview*.

What’s in this section? This section contains the following topics:

	Topic	See Page
5.1	Overview	147
5.2	How to Power Up the Controller	148
5.3	Entering a Security Code	150
5.4	Monitoring Your Controller	151
5.5	Start-up Procedure	155
5.6	Operating Modes	156
5.7	Setpoints	160
5.8	Setpoint Ramp Rate	163
5.9	Single Setpoint Ramp	164
5.10	Using Two Sets of Tuning Constants	168
5.11	Alarm Setpoints	171
5.12	Two Loops of Control Overview	172
5.13	Configuring Two Loops of Control	177
5.14	Monitoring Two Loops of Control	180
5.15	Operating Two Loops of Control	181
5.16	Three Position Step Control Algorithm	182
5.17	Input Math Algorithms	183
5.18	Digital Input Option (Remote Switching)	186
5.19	Auto/Manual Station	190
5.20	Fuzzy Overshoot Suppression	193
5.21	Accutune	194
5.22	Carbon Potential	202
5.23	HealthWatch	204

5.2 How to Power Up the Controller

Apply power When power is applied, the controller will run three diagnostic tests. All the displays will light and then the controller will go into automatic mode.

Diagnostic tests Table 5-1 lists the three diagnostic tests.

Table 5-1 Power Up Diagnostic Tests

Prompt on Lower Display	Condition
RAM TEST	Check RAM
CONFTEST	Check Non-volatile Memory
CAL TEST	Check Calibration

Test failures If one or more of these tests fail, the controller will go to the Fail-safe Manual Mode, and “FAILSAFE” will flash in the lower display.

If the output type is Position Proportional, and AUTO-CAL has never been done, a prompt “CAL MTR” will appear suggesting that the controller be calibrated.

Troubleshooting Refer to “STATUS TESTS” in *Section 9 - Troubleshooting* to identify and correct the problem.

Check the displays and keys Use the procedure in Table 5-2 to run the display and key test.

Table 5-2 Procedure for Testing the Displays and Keys

Press	Result																				
<div style="text-align: center;"> <div style="border: 1px solid black; padding: 2px; width: fit-content; margin: 0 auto;">SET UP</div> <p>and hold in, then</p> <div style="border: 1px solid black; padding: 2px; width: fit-content; margin: 0 auto;">FUNCTION LOOP 1/2</div> <p>at the same time</p> </div>	<p>The controller will run a display test. All the displays will light for 8 seconds, then the displays will look like this:</p> <div style="text-align: center;"> <p>Upper Display</p> <div style="border: 1px solid black; padding: 2px; width: fit-content; margin: 0 auto;">keys</div> <p>Lower Display</p> <div style="border: 1px solid black; padding: 2px; width: fit-content; margin: 0 auto;">try all</div> </div>																				
<p>Press each key to see if it works</p>	<p>When the key is pressed, the lower display will indicate the name of the key pressed.</p> <table border="1" data-bbox="862 680 1414 1031"> <thead> <tr> <th>Key Pressed</th> <th>Lower Display</th> </tr> </thead> <tbody> <tr> <td>FUNCTION LOOP 1/2</td> <td>FUNCTION</td> </tr> <tr> <td>LOWER DISPLAY</td> <td>LWR DISP</td> </tr> <tr> <td>MANUAL/AUTO</td> <td>AUTO MAN</td> </tr> <tr> <td>SETPOINT/SELECT</td> <td>SP SEL</td> </tr> <tr> <td>▲</td> <td>INCRMENT</td> </tr> <tr> <td>▼</td> <td>DECRMENT</td> </tr> <tr> <td>RUN/HOLD</td> <td>RUN HOLD</td> </tr> <tr> <td>▲ + ▼</td> <td>INCRDECR</td> </tr> <tr> <td>FUNCTION+SETUP</td> <td>FUNC SU</td> </tr> </tbody> </table>	Key Pressed	Lower Display	FUNCTION LOOP 1/2	FUNCTION	LOWER DISPLAY	LWR DISP	MANUAL/AUTO	AUTO MAN	SETPOINT/SELECT	SP SEL	▲	INCRMENT	▼	DECRMENT	RUN/HOLD	RUN HOLD	▲ + ▼	INCRDECR	FUNCTION+SETUP	FUNC SU
Key Pressed	Lower Display																				
FUNCTION LOOP 1/2	FUNCTION																				
LOWER DISPLAY	LWR DISP																				
MANUAL/AUTO	AUTO MAN																				
SETPOINT/SELECT	SP SEL																				
▲	INCRMENT																				
▼	DECRMENT																				
RUN/HOLD	RUN HOLD																				
▲ + ▼	INCRDECR																				
FUNCTION+SETUP	FUNC SU																				

If no key is pressed for 20 seconds, the test will time out and the controller will go into control mode.

If any test fails, go to “Controller Failure Symptoms” in *Section 9 - Troubleshooting*.

Key error

When a key is pressed and the prompt “KEY ERROR” appears in the lower display, it will be for one of the following reasons:

- parameter is not available,
- not in Set Up mode, press SET UP key first,
- key malfunction, do keyboard test.

5.3 Entering a Security Code

Introduction

The LOCKOUT feature in the UDC 3300 is used to inhibit changes (via keyboard) of certain functions or parameters by unauthorized personnel. There are different levels of LOCKOUT depending on the level of security required. These levels are:

NONE
 CALIB
 +CONF
 +VIEW
 MAX

See *Section 4 - Configuration Definitions* for details.

Security code numbers

The level of keyboard lockout may be changed in the Set Up mode. However, knowledge of a security code number (1 to 4095) may be required to change from one level of lockout to another. When a controller leaves the factory, it has a security code of 0 which permits changing from one lockout level to another without entering any other code number.




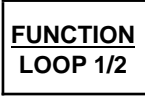
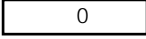



Procedure

If you require the use of a security code, select a number from 0001 to 4095 and enter it when the lockout level is configured as NONE. Thereafter, that selected number must be used to change the lockout level from something other than NONE.

CAUTION Write the number on the Configuration Record Sheet in the configuration section so you will have a permanent record.

Use the procedure in Table 5-3 to enter a security code.

Table 5-3 Procedure for Entering a Security Code

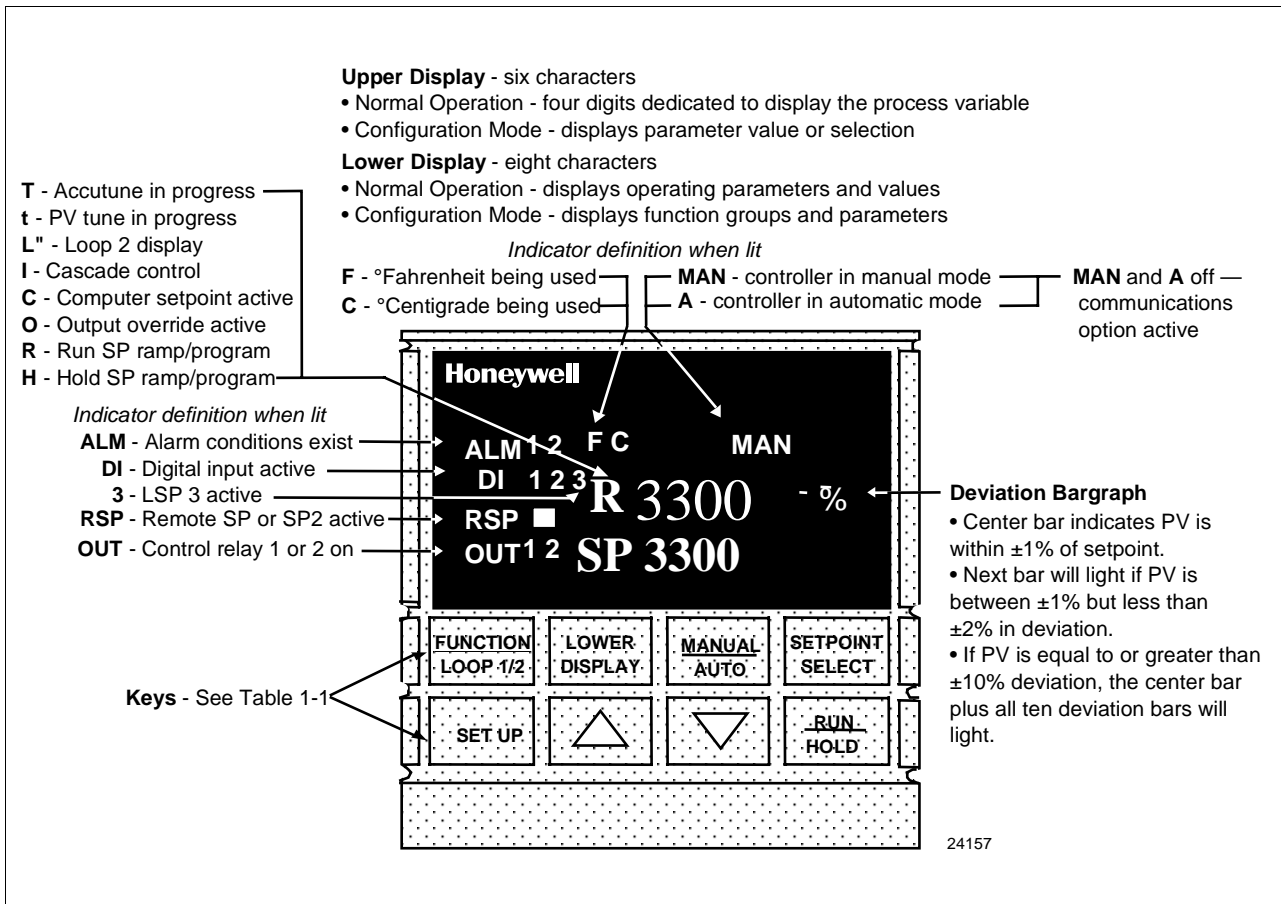
Step	Press	Action
1		until you see Upper Display  Lower Display 
2		until you see Upper Display  Lower Display 
3	 or 	to enter a four digit number in the upper display (1 to 4095) This will be your security code.

5.4 Monitoring Your Controller

Operator interface The indicators and displays on the operator interface let you see what is happening to your process and how the controller is responding.

Figure 5-1 is a view of the operator interface. A description of the displays and indicators is included.

Figure 5-1 Operator Interface



Decimal point position In each display, when no decimal place is configured, the right-most character is blank.

When a single decimal position has been configured and values greater than 1000 are displayed, the right-most character is blank but the decimal point will be lit.

Annunciators

The following annunciator functions have been provided:

A visual indication of each alarm

ALM 1 2

Blinking 1 indicates alarm latched and needs to be acknowledged before extinguishing when the alarm condition ends.

A visual indication of the control relays

OUT 1 2

A visual indication of the mode of the controller

A—Automatic Mode

MAN—Manual Mode

A visual indication of the temperature units

F—Degrees Fahrenheit

C—Degrees Celsius

A visual indication of the digital inputs

1 2

A visual lamp when the RSP or LSP 2 is active



A visual indication when LSP 3 is active

3

The upper left digit of the display is used to show other annunciator functions

T—Accutuning in process

t—PV tune in process

L''—Loop 2 display

I—Cascade control (when Loop 1 is displayed)

C—Computer setpoint active

O—Output override active

Viewing the operating parameters

Press the **LOWER DISPLAY** key to scroll through the operating parameters listed in Table 5-4. The lower display will show only those parameters and their values that apply to your specific model and the way in which it was configured.

Table 5-4 Lower Display Key Parameter

Lower Display Indication	Description
OUT	OUTPUT #1—Output value is percent; for Three Position Step control, this is an estimated motor position when no slidewire exists.
OT2	OUTPUT #2—Appears only if 2-loop or Cascade control is configured.
SP	LOCAL SETPOINT #1—Also current setpoint when using SP Ramp.
2SP	LOCAL SETPOINT #2
3SP	LOCAL SETPOINT #3
RSP	REMOTE SETPOINT
1IN	INPUT 1—Used only with combinational input algorithms.
2IN	INPUT 2
3IN	INPUT 3
POS	SLIDEWIRE POSITION—Used only with TPSC.
CSP	COMPUTER SETPOINT—When SP is in override.
DEV	DEVIATION—Maximum negative display is -999.9.
PIDSETX	TUNING PARAMETER SET 1—Selected set for single loop or primary loop configuration where X is either 1 or 2.
2PIDSETX	TUNING PARAMETER SET 2—Selected set for secondary loop configuration where X is either 1 or 2.
ET XX.XX	ELAPSED TIME—Time that has elapsed on timer in Hours.Minutes.
TR XX.XX	TIME REMAINING—Time that remains on timer in Hours.Minutes
RAMPXXXM	SETPOINT RAMP TIME—Time remaining in the setpoint ramp in minutes.
O SK XXXX	TIME REMAINING IN SOAK
1PV	PROCESS VARIABLE 1—For Cascade or 2-loop applications.
2PV	PROCESS VARIABLE 2—For cascade or 2-loop applications.
AUX	AUXILIARY OUTPUT—Displayed only when Loop 2 is not used, or when Loop 2 is Time Simplex and Loop 1 is not Current Duplex.
OC1	CHARACTERIZED OUTPUT 1—Displayed if Loop 1 output is characterized.
OC2	CHARACTERIZED OUTPUT 2—Displayed if Loop 2 output is characterized.
SPn	SP RATE SETPOINT—Current setpoint for setpoint rate applications
Σ (Sigma)	CURRENT TOTALIZER VALUE—Displays the total flow volume being measured.
BIA	BIAS—Displays the manual reset value for algorithm PD+MR.
TUNE OFF	LIMIT CYCLE TUNING NOT RUNNING—Appears when Accutune is disabled.
TUNE RUN	LIMIT CYCLE TUNING RUNNING—Appears when Accutune is enabled.
ToBEGIN	RESET SP PROGRAM TO START OF FIRST SEGMENT
OTI	OUTPUT OVERRIDE (2 PID LOOPS ONLY)—Appears when Internal Loop 1 Output value is displayed. This represents the internal output 1 value before override.

Diagnostic error messages

The UDC 3300 performs background tests to verify data and memory integrity. If there is a malfunction, an error message will be displayed. In the case of more than one simultaneous malfunction, only the one with the highest priority will appear on the lower display.

A list of error messages is contained in Table 5-5. If any of these error messages occur, refer to *Section 9 - Troubleshooting* for information to correct the failure.

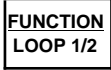
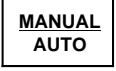











Table 5-5 Error Messages

Prompt	Description
EE FAIL	Unable to write to nonvolatile memory.
INP1FAIL	Two consecutive failures of input 1 integration.
INP2FAIL	Two consecutive failures of input 2 integration.
INP3FAIL	Two consecutive failures of input 3 integration.
SW FAIL	Slidewire input failure. Position Proportional Control automatically switched to Three Position Step Control.
CONF ERR	Configuration Errors for Loop 1—Low limit greater than high limit for PV, SP, Reset, or Output.
CONF ER2	Configuration Errors for Loop 2—Low limit greater than high limit for PV, SP, Reset, or Output, or Loop 2 output has not been selected.
SOOTING	Input Combination Errors—Percent Carbon falls outside of “sooting boundary.”
IN1 RNG	Input 1 Out-of-Range Out-of-range criteria: Linear range: $\pm 10\%$ out-of-range Characterized range: $\pm 1\%$ out-of-range
IN2 RNG	Input 2 Out-of-Range—Same as Input 1.
IN3 RNG	Input 3 Out-of-Range—Same as Input 1.
PV RNG	PV Out-of-Range $PV = (PV \text{ source} \times PV \text{ source ratio}) + PV \text{ source bias}$
FAILSAFE	Failsafe Loop 1—Check inputs or configuration.
FAILSF2	Failsafe Loop 2—Check inputs or configuration.
RV LIMIT	Remote Variable Out-of-Range $RV = (RV \text{ source} \times RV \text{ source ratio}) + RV \text{ source bias}$
RH LO	RH Excessive Temperature Depression—Calculated % RH is less than 0 %.
SEG ERR	Segment Error—SP Program starting segment number is less than ending segment number.
CAL MTR	Not calibrated. Perform Position Proportional calibration.

5.5 Start-up Procedure

Procedure The Start-up procedure is given in Table 5-6.

Table 5-6 Procedure for Starting Up the Controller

Step	Operation	Press	Action
1	Select the loop		to toggle between Loop 1 and Loop 2, if configured.
2	Select manual mode		until "MAN" indicator is ON. The controller is in manual mode.
3	Adjust the output	 or 	to adjust the output value and ensure that the final control element is functioning correctly. Upper Display  ← shows the PV value Lower Display  ← shows OUT and the output value in %.
4	Enter the local setpoint		Upper Display  ← shows the PV Value Lower Display  ← SP and the local setpoint value
		 or 	to adjust the local setpoint to the value at which you want the process variable maintained. The local setpoint cannot be changed if the Setpoint Ramp function is running. "R" appears in the upper display.
5	Select Automatic Mode		until "A" indicator is ON. The controller is in Automatic mode. The controller will automatically adjust the output to maintain the process variable at setpoint, if the controller is properly tuned.
6	Tune the controller		Tuning is required on the first startup. First enable "TUNE" selection in the Accutune Group. Refer to Tuning Set Up group to ensure that the proper selections for PROP BD or GAIN, RATE MIN, and RSET MIN, or RSET RPM, have been entered. Use Accutune to tune the controller; see the procedure in this section. For 2-loop or Cascade control, refer to the Loop 2 Tuning Set Up group parameters. To tune your controller manually, see <i>Appendix A</i> .

5.6 Operating Modes

Available modes

The controller can operate in any of three basic modes:

- Manual—One or Two Loops
- Automatic with Local Setpoint—One or Two Loops
- Automatic with Remote Setpoint—One or Two Loops
- Manual Cascade
- Automatic Cascade

The manual and automatic control modes with Local and Remote setpoint are standard with the instrument; cascade control is optional.

Mode definitions

Table 5-7 lists the available modes and their definitions.

Table 5-7 Operating Mode Definitions

Operating Mode	Definition
MANUAL	In the manual mode, the operator directly controls the controller output level. The process variable and the percent output are displayed. The configured High and Low Output Limits are disregarded and the operator can change the output value using the increment and decrement keys to the limits allowed by the output type (0 % to 100 % for a time proportioning output or –5 % to 105 % for a current output).
AUTOMATIC with LOCAL SETPOINT	In automatic local mode, the controller operates from the local setpoints and automatically adjusts the output to maintain the setpoint at the desired value. In this mode you can adjust the setpoint. <i>See Section 5.7 - Setpoints.</i>
AUTOMATIC with REMOTE SETPOINT	In automatic remote mode, the controller operates from the setpoint measured at the Remote setpoint input. Adjustments are available to ratio this input and add a constant bias before it is applied to the control equation. <i>See Section 3 - Configuration, Control Set up group.</i>
MANUAL CASCADE	In the manual cascade mode, both control loops are in manual although there is still only one output active. This mode is used to bring both loops into a reasonable operation area, at which point the unit is placed into the automatic cascade mode. If Loop 1 is placed in Manual control mode, then Loop 2, if in auto, is then placed in a pseudo-manual mode thereby eliminating output bumps when Loop 1 is returned to Automatic control mode.
AUTOMATIC CASCADE	In Automatic cascade mode, there are two control loops, with one loop's output acting as the setpoint for the second control loop. There is only one physical output in this mode.

What happens when you change modes

Table 5-8 explains what happens to the controller when you switch from one mode to another.

Table 5-8 Changing Operating Modes

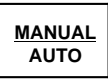


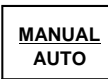


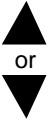



Mode Change	Description
Manual to Automatic Local Setpoint	<p>The Local Setpoint is usually the value previously stored as the Local Setpoint.</p> <p>PV tracking is a configurable feature which modifies this. For this configuration, when a loop is in manual mode, the local setpoint value tracks the process variable value continuously.</p>
Manual or Auto Local to Automatic Remote SP	<p>The Remote Setpoint uses the stored ratio and bias to calculate the control setpoint.</p> <p>Auto bias is a configurable feature which modifies this. When it is selected the transfer from automatic local to automatic remote or from manual remote to automatic remote adjusts the bias based on the local setpoint such that $Bias = LSP - (RSP\ Input \times R)$.</p>
Automatic Remote Setpoint to Manual or Auto Local Setpoint	<p>If configured for Local Setpoint Tracking, when the controller transfers out of remote setpoint the last value of the control setpoint is inserted into the local setpoint.</p> <p>If LSP tracking is not configured, the local setpoint will not be altered when the transfer is made.</p>

Selecting manual or automatic mode

An alternate action switch places the controller in the Automatic or Manual mode of operation. Switching between manual and automatic will be bumpless, except when PD+MR algorithm is selected.

Table 5-9 includes procedures for selecting automatic or manual mode and changing the output while in manual.

Table 5-9 Procedure for Selecting Automatic or Manual Mode

Step	Operation	Press	Action
1	Selecting Automatic Mode		<p>until "A" indicator is ON. The controller regulates its output to maintain the PV at the desired setpoint.</p> <p>Upper Display  ← shows the PV value</p> <p>Lower Display  ← shows SP and the setpoint value</p> <p>The deviation bargraph indicates the PV deviation from the setpoint.</p> <p>The annunciators indicate whichever setpoint is in use: SP Local Setpoint 2SP Second Local Setpoint 3SP Third Local Setpoint RSP Remote Setpoint CSP Computer Setpoint</p>
2	Selecting Manual Mode		<p>until "MAN" indicator is ON. The controller holds its output at the last value used during automatic operation and stops adjusting the output for changes in setpoint or process variable.</p> <p>Upper Display  ← shows the PV value</p> <p>Lower Display  ← shows OUT and the output value in (%).</p> <p>The deviation bargraph indicates the PV deviation from the setpoint.</p>
3	Adjust the Output in Manual Mode		<p>to adjust the output value while in manual mode.</p> <p>Upper Display  ← shows the PV value</p> <p>Lower Display  ← shows OUT and the output value in %.</p>
4	Return to Automatic Mode		<p>The "A" indicator will appear indicating Automatic mode.</p>

Position proportional backup mode

This feature provides for Position Proportional models to automatically change to a Three Position Step algorithm if the slidewire input signal fails. This will maintain control of your process.

“IN2 RNG” or “SW FAIL” will flash in the lower display and the “OUT” display will show an estimated motor position WITHOUT a decimal point.

5.7 Setpoints

Introduction

You can configure the following setpoints for the UDC 3300 controller.

- A single local setpoint,
- Two local setpoints,
- One local setpoint and one remote setpoint,
- Three local setpoints,
- Two local setpoints and one remote setpoint.

To scroll through the setpoint type menu, press and hold in the **SETPOINT SELECT** key. Release when the desired setpoint selection is displayed.

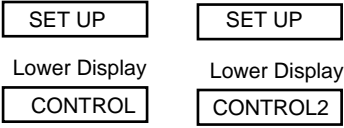

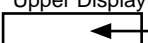
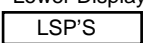

ATTENTION “KEY ERROR” will appear in the lower display if:

- You choose either local setpoint 2 or 3 or remote setpoint and your choice has not been configured as the setpoint source.
- You attempt to change the setpoint while a setpoint ramp is enabled. Setpoint ramp rate will apply, if enabled.

Selecting the local setpoint source

Use the procedure in Table 5-10 to select a local setpoint source.



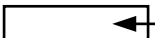



Table 5-10 Procedure for Selecting the Local Setpoint Source

Step	Operation	Press	Action
1	Enter Set Up mode	LOWER DISPLAY	until the displays read: Upper Display Upper Display  Lower Display Lower Display  for Loop 1 or for Loop 2
2	Display Local Setpoint Source selections	FUNCTION LOOP 1/2	until the displays read: Upper Display  Setpoint source selections 1 ONLY Lower Display TWO  THREE
3	Select the desired source	 or	to select the desired setpoint source in the upper display.
4	Return to control	LOWER DISPLAY	The controller will assume normal control.

Changing local setpoint 1, 2, or 3 Use the procedure in Table 5-11 to change any of the local setpoint values.


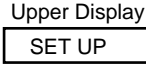
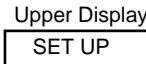


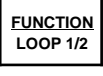

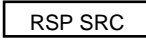


After changing a local setpoint value, if no other key is pressed, a minimum of 30 seconds time will elapse before the new value is stored in nonvolatile memory. If power is removed before this time, the new setpoint value is lost and the previous setpoint value is used at power up. If after changing the LSP value another key is pressed, then the value is stored immediately.

Table 5-11 Procedure for Changing the Local Setpoints

Step	Operation	Press	Action
1	Select the setpoint		until you see Upper Display  The PV value Lower Display  SP, 2SP, or 3SP and the local setpoint value or RSP and the remote setpoint value
2	Select a different setpoint or the remote setpoint	 and hold in	to cycle through the setpoint type menu as long as the key is pressed. When the key is released, the setpoint selection currently displayed will be the new setpoint selection.
3	Change the value	 or 	to change the local setpoint to the value at which you want the process maintained. SP, 2SP, or 3SP indicator will light to match the lower display. ATTENTION The remote setpoint cannot be changed at the keyboard.

Enabling (or disabling) the remote setpoint Use the procedure in Table 5-12 to enable the remote setpoint source.

Table 5-12 Procedure for Enabling (or Disabling) the Remote Setpoint

Step	Operation	Press	Action
1	Select Set Up Group		until you see: Upper Display  Upper Display  Lower Display  Lower Display  for Loop 1 or for Loop 2
2	Select the Remote Setpoint Source prompt		Until you see: Upper Display  The Remote Setpoint source selection Lower Display  NONE—not used INP 2—Input 2 as RSP IN AL1—Input algorithm 1 IN AL2—Input algorithm 2 INP 3—Input 3 as RSP
3	Change selection	 or	to enable or disable the remote setpoint. ATTENTION You cannot change the remote setpoint value using these keys.
4	Return to normal operation		This will return the controller to normal operation.

Setpoint selection indication

Table 5-13 shows how the indicators react and what the displays show for each type of setpoint.

Table 5-13 Setpoint Selection Indication

	Using Local Setpoint	Using Remote Setpoint	Using 2nd Local Setpoint	Using 3rd Local Setpoint
	SP	RSP	2SP	3SP
Upper Display	PV and the PV value	PV and the PV value	PV and the PV value	PV and the PV value
Lower Display	SP and the Local Setpoint Source	RSP and Remote Setpoint Value	2SP and the 2nd Local Setpoint Value	3SP and the 3rd Local Setpoint Value
Annunciator	None	"■" lights	"■" lights	"3" lights

5.8 Setpoint Ramp Rate

Configuration

You can configure a Setpoint Ramp Rate that will apply to any Local setpoint change immediately.

Refer to the Configuration Section to enable the ramp for either loop and set an upscale or downscale rate value.

Make sure SP RAMP and SP PROG are disabled.

Operation

When a local setpoint change is made, the controller will ramp from the original setpoint to the new one at the rate specified. This changing (current) setpoint can be viewed as SPn on the lower display.

Press the LOWER DISPLAY key until you see SPn and the setpoint value in the lower display.

5.9 Single Setpoint Ramp

Configuring the setpoint ramp


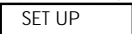

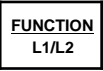
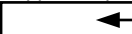


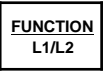
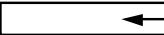


You can configure a single setpoint ramp to occur between the current local setpoint and a final local setpoint over a time interval of from 1 to 255 minutes. You can RUN or HOLD the ramp at any time.

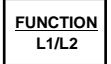
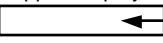



ATTENTION The UDC 3300 has PV Hot Start functionality as standard feature. This means that at power-up Local Setpoint #1 is set to the current PV value and the Ramp, Rate, or Program then starts from this value.

Procedure

Table 5-14 lists the procedure for configuring the Setpoint Ramp parameters. The procedure for **SP Program** is in *Section 6 – Setpoint Programming Option*.

Table 5-14 Procedure for Configuring a Setpoint Ramp

Step	Operation	Press	Action
1	Select SP RAMP Set Up Group		until you see: Upper Display  Lower Display 
2	Select the Setpoint Ramp function		until you see: Upper Display  ← DISABLE—Disables SP Ramp Lower Display  ENABLE—Enables SP Ramp for Loop 1 ENABL2—Enables SP Ramp for Loop 2 ENAB12—Enables Sp Ramp for Loops 1 and 2
3	Enable Setpoint Ramp		to enable the setpoint ramp function. Choose the loop(s) on which you want the ramp to operate. ATTENTION You cannot change the current local setpoint if the setpoint ramp function is enabled. Make sure SP RATE is disabled.
4	Set the Ramp Time		until you see: Upper Display  ← The ramp time in minutes Lower Display 
		 or	to change the upper display value to the number of minutes in which you want the final setpoint to be reached. Setting Range = 1 to 255 minutes ATTENTION Entering “0” will imply an immediate step change to the final SP.

Step	Operation	Press	Action
5	Set the Final Setpoint value		<p>Upper Display</p>  — The final Setpoint value <p>Lower Display</p> 
			<p>to change the upper display value to the desired final setpoint value.</p> <p>Setting Range = within the setpoint limits</p>
6	Exit Configuration		To exit configuration.

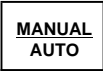












Running the setpoint ramp



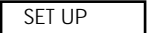

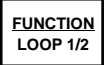






Running a Setpoint Ramp includes starting, holding, viewing the ramp time, ending the ramp, and disabling it.

Procedure

Table 5-15 lists the procedure for running the Setpoint Ramp.

Table 5-15 Procedure for Running a Setpoint Ramp

Step	Operation	Press	Action
1	Put the controller into Automatic mode		until "A" indicator is ON and you will see: Upper Display  ← H and the PV value Lower Display  ← SP and the present setpoint value
2	Set Start Setpoint	 or	until the start setpoint value you desire is indicated in the lower display: Upper Display  ← H and the PV value Lower Display  ← SP and the start setpoint value
3	Start the Ramp		You will see: Upper Display  ← R and the PV value Lower Display  ← SP and a changing setpoint value ATTENTION The value in the lower display will be increasing or decreasing toward the final setpoint value. The PV value in the upper display will also change.
4	Hold/Run the Ramp		This holds the ramp at the current setpoint value. Press again to continue run.
5	View the remaining ramp time		until you see: Upper Display  ← R or H and the PV value Lower Display  ← RAMP XXXM (Time remaining)

Step	Operation	Press	Action
6	Change setpoint during Hold mode	 or	<p>to change the “HELD” setpoint if the ramp is on “HOLD.”</p> <p>However, the ramp time remaining is not changed. Therefore, when returning to RUN mode, the setpoint will ramp at the same rate as prior to local setpoint changes and will stop if the final setpoint is reached before time expires.</p> <p>If the time expires before the final setpoint is reached, it will jump to the final setpoint.</p>
7	End the Ramp		<p>When the final setpoint is reached, the “R” changes to “H” in the upper display and the controller operates at the new setpoint.</p> <p>ATTENTION Any time the local setpoint is different from the final setpoint value and the RUN/HOLD key is pressed, the ramp will start again.</p>
8	Disable the setpoint ramp function		<p>until you see:</p> <p>Upper Display </p> <p>Lower Display </p>
			<p>You will see:</p> <p>Upper Display  ← DISABL—Disables SP Ramp</p> <p>Lower Display  SP RAMP</p> <p>ENABLE—Enables SP Ramp for Loop 1 ENABL2—Enables SP Ramp for Loop 2 ENAB12—Enables Sp Ramp for Loops 1 and 2</p>
			<p>until you see:</p> <p>Upper Display  DISABL</p> <p>Lower Display  SP RAMP</p>
9	Return to normal operating mode		

5.10 Using Two Sets of Tuning Constants

Introduction

You can use two sets of tuning constants for single output types and 2-loop or cascade control, and choose the way they are to be switched. (Does not apply for Duplex control.)

The sets can be:

- keyboard selected,
- automatically switched when a predetermined process variable value is reached,
- automatically switched when a predetermined setpoint value is reached.

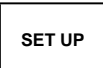




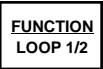



The following procedures show you how to:

- select two sets or gain scheduling,
- set the switch-over value,
- set tuning constant value for each set, and
- switch between two sets via the keyboard (without automatic switchover)

Select two sets or gain scheduling

The procedure in Table 5-16 tells you how to select two sets or gain scheduling.

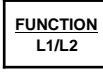
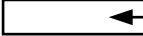


Table 5-16 Procedure for Selecting Two Sets of Tuning Constants

Step	Operation	Press	Action
1	Select Control Set Up group		until you see: Upper Display  Upper Display  Lower Display  Lower Display  for Loop 1 or for Loop 2
2	Select PID SETS function		until you see: Upper Display  Available selections are listed below Lower Display  1 ONLY —1 set of constants 2KEYBD —2 sets, keyboard selectable 2 PVSW —2 sets, auto switch at PV value 2 SPSW —2 sets, auto switch at SP value GAIN S —Gain used in control algorithm calculations can be pre-entered into eight user-defined segments, with each segment applied over a user-defined PV range. Refer to <i>Section 3 – Configuration</i> under Tuning Set Up group to set Gain segment values and PV range values.
		 or	to select the type of PID SET.

Set switchover value

If you select 2 PVS_W or 2 SPS_W, you must set a value at which the sets will switch over. The procedure in Table 5-17 shows you how to set this value. *This procedure assumes that you are still in the Control Set Up group from Table 5-16.*




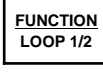



Table 5-17 Procedure for Setting Switchover Values

Step	Operation	Press	Action
1	Select Switchover value function	 assuming you are still in Control Set Up group	until you see: Upper Display  ← The switchover value Lower Display 
		 or	to select the switch-over value in the upper display.

Set tuning constant values for each set

There are specific tuning constants that must be set for each set. The procedure in Table 5-18 shows you how to access these constants and change their values.

Table 5-18 Procedure for Setting Tuning Constant Values

Step	Operation	Press	Action
1	Select Tuning Set Up Group		until you see: Upper Display  Lower Display 
2	Select the tuning constants		to successively display the following constants: Upper Display  ← The tuning constant value Lower Display  ← <ul style="list-style-type: none"> PROP BD or GAIN* RATE* RSET* CYC SEC or CYC SX3* PROP BD2 or GAIN2** RATE 2** RSET2** CYC2 SEC or CYC2 SX3**
		 or	To change the value of any of the above listed prompts in the lower display.





*PIDSET1 will be used when PV or SP, whichever is selected, is *greater* than the switch-over value.

**PIDSET2 will be used when PV or SP, whichever is selected, is *less* than the switch-over value.

Switch between two sets via the keyboard (without automatic switchover)

This procedure is operational only if 2 PID SETS was configured at the Control Set Up group. The procedure in Table 5-19 shows you how to switch from one set to another.

Table 5-19 Procedure for Switching PID SETS from the Keyboard

Step	Operation	Press	Action
1	Access the PID set display		until you see: Upper Display  ← The PV value Lower Display  X = 1 or 2
		 or	to change PID SET 1 to PID SET 2 or vice versa. You can use Accutune on each set.

5.11 Alarm Setpoints

Introduction

An alarm consists of a relay contact and an operator interface indication. The alarm relay is de-energized if setpoint 1 or setpoint 2 is exceeded. The alarm relay is energized when the monitored value goes into the allowed region by more than the hysteresis.




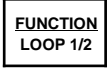

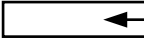


The relay contacts can be wired for normally open (NO) energized or normally closed (NC) de-energized at the rear terminals. See Table 2-8 in the *Section 2 – Installation* for alarm relay contact information.

There are four alarm setpoints, two for each alarm. The type and state (High or Low) is selected during configuration. See *Section 3 – Configuration* for details.

Procedure for displaying the alarm setpoints

Table 5-20 lists the procedure for displaying and changing the alarm setpoints.

Table 5-20 Procedure for Displaying or Changing the Alarm Setpoints

Step	Operation	Press	Action
1	Access the Alarm Set Up group		until you see: Upper Display  Lower Display 
2	Access the Alarm Setpoint Values		to successively display the alarm setpoints and their values. Their order of appearance is shown below. Upper Display  ← The alarm setpoint value Lower Display  A1S1 VAL = (Alarm 1, Setpoint 1 value) A1S2 VAL = (Alarm 1, Setpoint 2 value) A2S1 VAL = (Alarm 2, Setpoint 1 value) A2S2 VAL = (Alarm 2, Setpoint 2 value)
		 or	to change any alarm setpoint value you select in the upper display.
3	Return to normal operation		

5.12 Two Loops of Control Overview

Introduction

The UDC 3300 can operate using two independent loops of control or internal Cascade control.

Available only on Expanded Model DC330E-XX-XXX.

TWO INDEPENDENT LOOPS—See Functional Overview Block Diagrams for Loop 1 and Loop 2 (Figure 5-2) and Table 5-21 for selections based on these diagrams.

The following rules apply for two independent loops:

- Current output on Loop 2 requires auxiliary output.
- Loop 2 Current Duplex output is limited to 2nd Current output signal only.
- Loop 2 relay output is always dedicated to relay output 2.
- No Time Duplex outputs on Loop 2.
- No ON/OFF or 3 Position Step algorithms on Loop 2.
- No Position Proportional output is available on 2-loop controllers.

INTERNAL CASCADE CONTROL—See Functional Overview Block Diagram (Figure 5-3) and Table 5-25 for selections based on these diagrams.

The following rules apply for internal Cascade control:

- Loop 2 must be the primary loop.
- Loop 1 must be the secondary (internal or slave) loop because all output forms exist on Loop 1.
- Loop 1 remote setpoint is fixed as Loop 2 output.
- No Position Proportional output is available on cascade controllers.

Selections

Refer to Figures 5-2, 5-3, and 5-4 Block Diagrams and Table 5-21 for selections based on these diagrams.

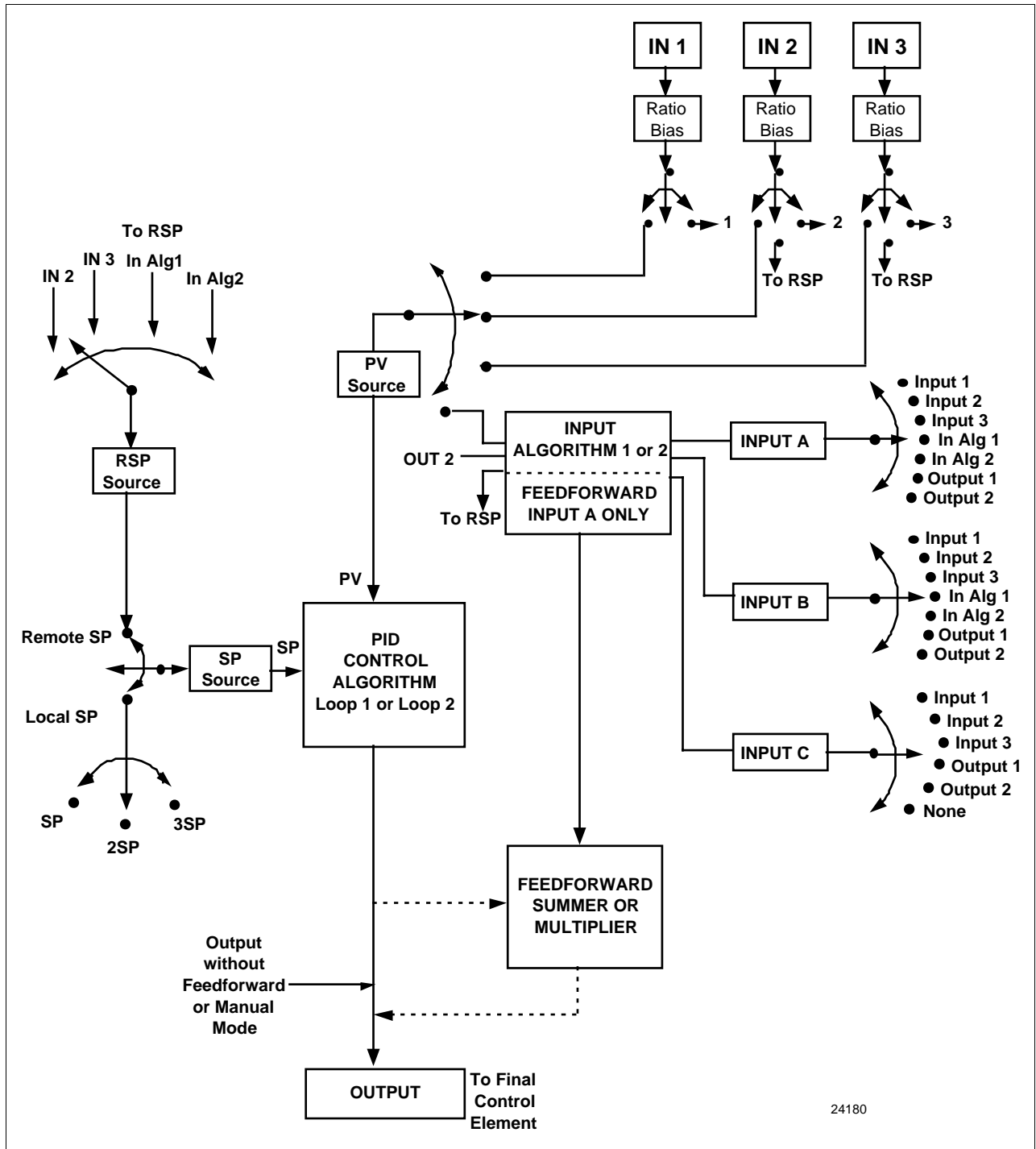
Table 5-21 Control Loop Selections

Loop		Input 1	Input 2	Input Algorithm
LOOP 1	Process Variable*	Via Configuration or Digital Inputs	Via Configuration or Digital Inputs	Yes
	Remote Setpoint	No	Via configuration or Digital Inputs	Yes
	Feedforward	No	Yes	Yes
LOOP 2	Process Variable*	Via Configuration or Digital Inputs	Via Configuration or Digital Inputs	Yes
	Remote Setpoint	No	Via Configuration or Digital Inputs	Yes
	Feedforward	No	Yes	Yes

*The PV may be a combination of multiple inputs via a Loop input algorithm.

Functional overview Figure 5-2 is a block diagram of a Loop 1 of a single loop controller and Loop 1 and Loop 2 of a dual loop controller.

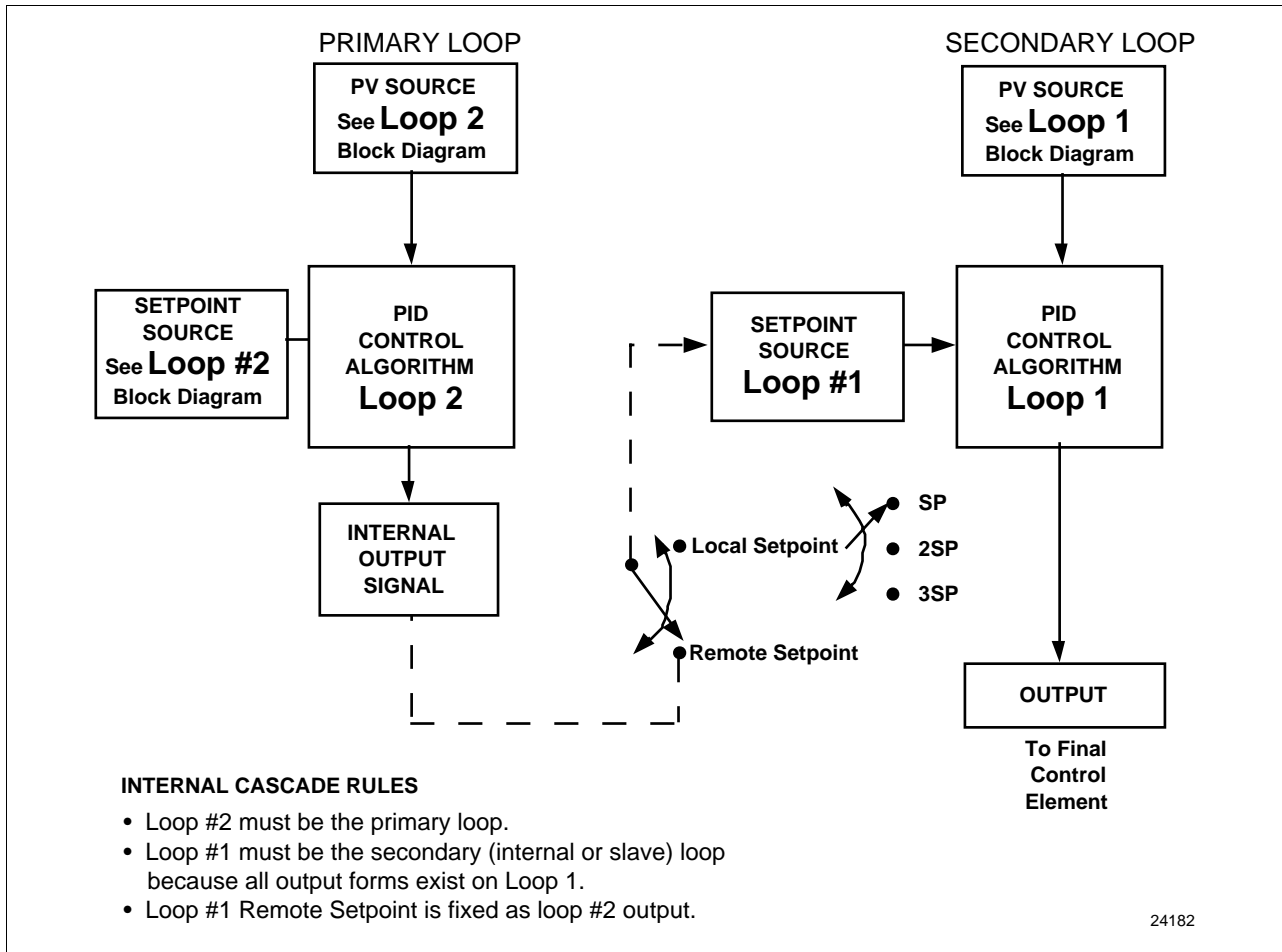
Figure 5-2 Functional Overview Block Diagram of a Single Loop (Loop #1) or Dual Loop Controller (Loop #1 and Loop #2)



Internal cascade

Figure 5-3 is a block diagram of internal Cascade for a 2-loop controller.

Figure 5-3 Functional Overview Block Diagram of Internal Cascade of a 2-loop Controller



Override rules

The UDC 3300 allows you to select high or low output override. Refer to *Section 3 - Configuration* to select High or Low.

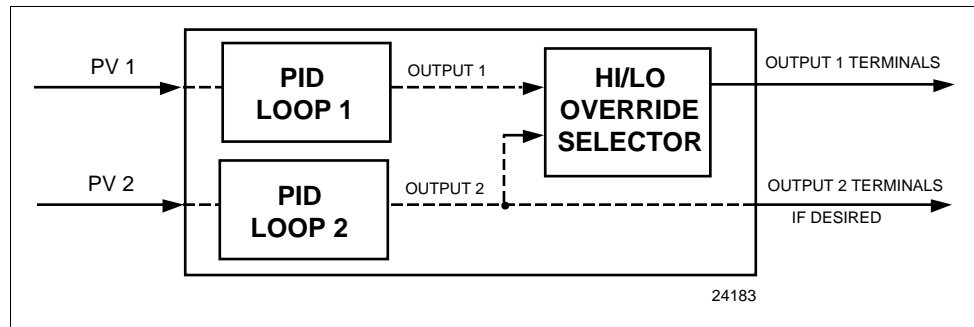
The following rules apply for high/low override:

- Only one physical output is required when override is enabled. It is the output from Loop 1 because Loop 2's internal output is routed through the selector.
- Loop 2 output can also be available at all times if desired.
- In Manual mode, the Output may be overridden.
- Does not apply for Three Position Step Control.
- OTI on bottom display shows value of the internal Loop 1 output before any override.

ATTENTION The output of the unselected loop tracks the selected loop to within 5 % when in Auto mode to eliminate windup. This tracking is done in the direction opposite to the Override Select configuration; i.e., for High Select, the unselected output tracks within 5 % of lower, and vice versa.

Figure 5-4 is a block diagram of the Hi/Lo Override Selector.

Figure 5-4 Hi/Lo Override Selector



Two-loop restrictions Table 5-22 gives two-loop functionality and restrictions for controllers with one current output (Auxiliary output) and three relay outputs.

Table 5-22 Two-loop Functionality and Restrictions (Model DC330E-EE-2XX or Model DC330E-EE-5XX)

Controller with One Current Output (Auxiliary Output) and Three Relay Outputs					
Output Type	Current	Auxiliary	Relay #1	Relay #2	Relay #3
Loop 1 is TIME SIMPLEX, Loop 2 is: Time Simplex Current or Current Duplex (100 %) Current/Time or Time/Current	N/A N/A N/A	Not used Loop 2 Output Loop 2: Output 1 or 2	Loop 1 Output Loop 1 Output Loop 1 Output	Loop 2 Output Alarm 2 Loop 2: Output 1 or 2	Alarm 1 Alarm 1 Alarm 1
Loop 1 is TIME DUPLEX/TPSC, Loop 2 is: Time Simplex (N/A) Current or Current Duplex (100 %) Current/Time or Time/Current (N/A)	— N/A —	— Loop 2 Output —	— Loop 1, Output 1 —	— Loop 1, Output 2 —	— Alarm 1 —
Loop 1 is CURRENT OUTPUT or CURRENT DUPLEX – 100 %, Loop 2 is: Time Simplex Current or Current Duplex (N/A) Current/Time or Time/Current (N/A)	N/A — —	Loop 1 Output — —	Loop 2 Output — —	Alarm 2 — —	Alarm 1 — —
Loop 1 is TIME/CURRENT or CURRENT/TIME, Loop 2 is: Time Simplex Current or Current Duplex (N/A) Current/Time or Time/Current (N/A)	N/A — —	Loop 1: Output 1 or 2 — —	Loop 1: Output 1 or 2 — —	Loop 2 Output — —	Alarm 1 — —

TWO-LOOP RESTRICTIONS:

1. Time Duplex and Three Position Step Control are not available on Control Loop 2.
2. Position Proportional Control is not available on Two-Loop or Cascade Controllers.
3. If either Time Duplex or Three Position Step Control is selected as Control Loop 1 Output, then Time Simplex, Current/Time Duplex and Time/Current Duplex are not available for Control Loop 2 Output.
4. Current Duplex 50 % is not available on Model No. DC330E-EE-2XX.

Two-loop restrictions Table 5-23 gives two-loop functionality and restrictions for controllers with two current outputs (including Auxiliary output) and two relay outputs.

Table 5-23 Two-loop Functionality and Restrictions (Model DC330E-KE-2XX or Model DC330E-KE-5XX)

Controller with Two Current Outputs (including Auxiliary Output) and Three Relay Outputs					
Output Type	Current	Auxiliary	Relay #1	Relay #2	Relay #3
Loop 1 is TIME SIMPLEX, Loop 2 is: Time Simplex Current or Current Duplex (100 %) Current/Time or Time/Current	Not used Not used Not used	Not used Loop 2 Output Loop 2: Output 1 or 2	N/A N/A N/A	Loop 1 Output Loop 1 Output Loop 1 Output	Loop 2 Output Alarm 1 Loop 2: Output 1 or 2
Loop 1 is TIME DUPLEX/TPSC, Loop 2 is: Time Simplex (N/A) Current or Current Duplex (100 %) Current/Time or Time/Current (N/A)	— Not used —	— Loop 2 Output —	— N/A —	— Loop 1,Output 1 —	— Loop 1,Output 2 —
Loop 1 is CURRENT OUTPUT or CURRENT DUPLEX – 100 %, Loop 2 is: Time Simplex Current or Current Duplex (100 %) Current/Time or Time/Current (N/A)	Loop 1 Output Loop 1 Output Loop 1 Output	Not used Loop 2 Ouput Loop 2: Output 1 or 2	N/A N/A N/A	Loop 2 Output Alarm 2 Loop 2: Output 1 or 2	Alarm 1 Alarm 1 Alarm 1
Loop 1 is CURRENT DUPLEX – 50 %, Loop 2 is: Time Simplex Current (N/A) Current/Time or Time/Current (N/A)	Loop 1,Output 1 — —	Loop 1,Output 2 — —	N/A — —	Loop 2 Output — —	Alarm 1 — —
Loop 1 is TIME/CURRENT or CURRENT/TIME, Loop 2 is: Time Simplex Current or Current Duplex (100 %) Current/Time or Time/Current	Loop 1: Output 1 or 2 Loop 1: Output 1 or 2 Loop 1: Output 1 or 2	Not used Loop 2 Output Loop 2: Output 1 or 2	N/A N/A N/A	Loop 1: Ouput 1 or 2 Loop 1: Output 1 or 2 Loop 1: Output 1 or 2	Loop 2 Output Alarm 1 Loop 2: Output 1 or 2




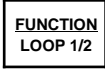



TWO-LOOP RESTRICTIONS:

1. Time Duplex and Three Position Step Control are not available on Control Loop 2.
2. Position Proportional Control is not available on Two-Loop or Cascade Controllers.
3. If either Time Duplex or Three Position Step Control is selected as Control Loop 1 Output, then Time Simplex, Current/Time Duplex and Time/Current Duplex are not available for Control Loop 2 Output.
4. Current Duplex 50 % is not available on Model No. DC330E-EE-2XX.

5.13 Configuring Two Loops of Control




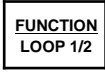
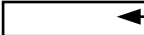
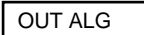

Select 2-loop algorithm The procedure in Table 5-24 shows you how select the 2-loop algorithm.

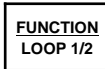

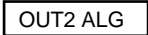

Table 5-24 Procedure for Selecting 2-loop Algorithm

Step	Operation	Press	Action
1	Select Algorithm Set Up Group		until you see: Upper Display  Lower Display 
2	Select the PID Loops		to successively display the following constants: Upper Display  ← 1 LOOP Lower Display  2LOOPS CASCAD
		 or	To select two Loops or Cascade control.

Select the output algorithm for each loop See *Section 5.12* for rules and regulations, then follow the procedure in Table 5-25.

Table 5-25 Procedure for Selecting Output Algorithm

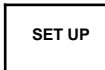

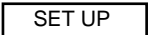


Step	Operation	Press	Action
1	Select Output Algorithm Set Up Group		until you see: Upper Display  Lower Display 
2	Select Loop 1 Algorithms		to successively display the following constants: Upper Display  ← TIME Lower Display  CURRNT POSITN TIME D CUR D CUR TI TI CUR
		 or	to select Loop 1 algorithm.

Step	Operation	Press	Action
3	Select Loop 2 algorithms		until you see: Upper Display  ← NONE Lower Display  CURRNT CUR D CUR TI TI CUR
		 or	to select Loop 2 algorithm.

Select control parameters for each loop

The procedure in Table 5-26 shows you how select the 2 loop algorithm.

Table 5-26 Procedure for Selecting Control Parameters

Step	Operation	Press	Action
1	Select Control Set Up Group		until you see: Upper Display Upper Display   Lower Display Lower Display   for Loop 1 or for Loop 2
2			Refer to <i>Section 5.12</i> for rules and restrictions and to <i>Section 3 – Configuration</i> to select the individual parameters.

5.14 Monitoring Two Loops of Control

Introduction

Monitoring two individual loops of control or internal Cascade is the same as a single loop except as indicated in Table 5-28.

Table 5-28 Digital Display Indication—Two Loops

Indicator	Loop Indication	Definition
<p>none (two-loop)</p> <p>I (cascade)</p>	Loop 1	<ul style="list-style-type: none"> Upper display shows the Process Variable (PV) for Loop 1 Lower display shows the Loop 1 parameters and the PV and Output for Loop 2 Controller setpoint annunciators show the setpoint currently being used for Loop 1
L”	Loop 2	<ul style="list-style-type: none"> Upper display shows the Process Variable (PV) for Loop 2 Lower display shows the Loop 2 parameters and the PV and Output for Loop 1 Controller setpoint annunciators show the setpoint currently being used for Loop 2

Loop display

Display of Loop 1 or Loop 2 (if configured) is selected by toggling the **FUNCTION / LOOP 1/2** key.

Viewing each loop’s process variable

Regardless of which loop is being displayed, 1 or 2, the process variable of the non-displayed loop can be shown in the lower display by repeated presses of the **LOWER DISPLAY** key until **1PVXXXX** or **2PVXXXX** is displayed.

Internal cascade indication

When internal Cascade has been configured, an “I” will appear on the left side of the upper display as long as Loop 1 is operating in the remote setpoint mode. Hold in the **SETPOINT SELECT** key until RSP appears in the lower display then release the key to select remote setpoint.

Switching between automatic and manual mode on either loop will not affect the internal Cascade indication.

5.15 Operating Two Loops of Control

Loop operation	Operation of two individual loops of control is identical to operating a single loop of control except that TUNING 2 group applies to Loop 2 only and two PID sets, 3 and 4, are available. TUNING group applies to Loop 1 with PID sets 1 and 2 applicable.
Operating modes and setpoint source	The rules for Auto/Manual modes and changing setpoint sources are the same as single loop operation.
Keyboard operation	Note that the loop being displayed is the only loop affected by normal keyboard operation. However, either loop can be reconfigured when in the Set Up mode regardless of which is being displayed during normal operation.
Accutune	Two independent loops or cascaded loops can be tuned at the same time, if configured.
Setpoint ramp or SP programming	<p>Either loop or both loops can be configured for a single setpoint ramp operation by enabling the desired loop or loops (see <i>Section 3 – Configuration</i>).</p> <p>An “H” or “R” will appear when applicable, depending upon which loop is being displayed.</p> <p>The RUN/HOLD operation is shown in Table 5-15 Procedure for Running a Setpoint Ramp.</p>
Digital inputs (remote mode switching)	Digital Input 2 is dedicated to Loop 2 and Digital Input 1 is dedicated to Loop 1 when two loops or Cascade control is configured.
Output override Hi/Lo select	<p>Output Override allows you to select the higher of Output 1 and Output 2 (Hi Select) or the lower of Output 1 and Output 2 (Lo Select) to appear at Output 1 terminals to drive the final control element. Refer to <i>Section 5.12</i> for Override rules and block diagram.</p> <p>Override prompts appear under the Algorithm Set Up group, function prompt OUT OVRD.</p>

5.16 Three Position Step Control Algorithm

Introduction

The Three Position Step Control algorithm (Loop 1 only) allows the control of a valve (or other actuator) with an electric motor driven by two controller output relays; one to move the motor upscale, the other to move it downscale, without a feedback slidewire linked to the motor shaft. Accutune **SP** or **SP+PV** tuning does not function with this algorithm. Accutune **TUNE** will operate with this algorithm.

Estimated motor position

Models DC330X-EE-XXX-X0, DC330X-AA-XXX-X0

The Three Position Step control algorithm provides an output display (OUT) which is an estimated motor position since the motor is not using any feedback. Although this output indication is only accurate to a few percent, it is corrected each time the controller drives the motor to one of its stops (0 % or 100 %).

It avoids all the control problems associated with the feedback slidewire (wear, dirt, noise). When operating in this algorithm, the estimated “OUT” display is shown to the nearest percent (i.e. no decimal).

Accurate motor position

Models DC330X-EE-XXX-X2, DC330X-AA-XXX-X2

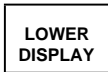
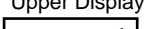
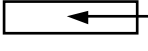
In the event that an accurate and repeatable indication in motor position is required, Position Proportional model’s slidewire input can be used to read the motor position and display it on the lower display as “POS” while still operating in the Three Position Step control mode.

The slidewire must be calibrated for this to operate correctly.

Displaying the motor position

Table 5-29 lists the procedure for displaying the motor position.

Table 5-29 Procedure for Displaying the 3PSTEP Motor Position

Step	Operation	Press	Action
1	Access the displays		<p>until you see:</p> <p>Upper Display</p>  ← The PV value
			<p>Lower Display</p>  ←
			<p>POS = 3PStep motor position with slidewire connected or OUT = Estimated 3PStep motor position when no slidewire exists</p>

Power-up output

When the controller powers up after a power outage, the position of the motor will correspond to whatever was configured at the Control Set Up function prompt PWR OUT, selection LAST or F’SAFE. Refer to *Section 4.10, Table 4-9* for definition of each selection.

5.17 Input Math Algorithms

Introduction

If selected via Math options, this controller has two input algorithms available. Each algorithm can be configured to provide a derived (calculated) PV or a derived remote setpoint. Up to three inputs may be applied to the calculation. In addition, the two algorithms may be “linked” to combine two calculations by configuring one algorithm to be an input to the other algorithm.

Standard functionality:

- Basic models (DC330B) contain as standard: Weighted Average, Feedforward Summer, Feedforward Multiplier.
- Expanded models (DC330E) provide as standard: Weighted Average, Feedforward Summer, Feedforward Multiplier, Relative Humidity.

The Math option, which provides additional algorithms plus two Characterizers, Totalizer, and Gain Scheduling, is available only on Expanded Model DC330E-XX-XXX.

Input algorithm selections

Algorithm selections are made in *Section 3 – Configuration*. The following function prompts can be found in the Algorithm Set Up group:

IN ALG1
IN ALG2

These selections include the following algorithms:

Weighted Average
Feedforward Summer
Relative Humidity
Summer
Hi Select
Lo Select
√ Multiply Divide
√ Multiply
Multiply Divide
Multiply
Feedforward Multiplier
Carbon Potential (several types)
Dewpoint

The formulas for these selections are given in Table 4-5 in *Section 4 – Configuration Prompt Definitions*.

Input A, Input B, and Input C selections for these formulas are found in *Section 4 – Configuration Prompt Definitions*; Set Up group ALGORITHM, under the following function prompts:

ALG1 INA
ALG1 INB
ALG1 INC
ALG2 INA
ALG2 INB
ALG2 INC

8-segment characterization

This is available as part of the Math Algorithm option. Two 8-segment selections can be made in *Section 3 – Configuration*; Set Up group ALGORITHM, under function prompts:

```
8SEG CH1
Xn VALUE
Yn VALUE
8SEG CH2
Xn VALU2
Yn VALU2
```

An 8-segment characterizer can be applied to either Input 1, Input 2, Output 1, or Output 2. When Input 1 or Input 2 is used, the selected input's Ratio and Bias are applied to the Xn values.

When one of the loop outputs is selected, the Xn Values are the output from the control algorithm, and the Yn Output is the final control element action.

An example of 8-segment characterization is shown in Figure 4-2.

Totalizer function

A **Flow Totalizer** is available as part of the Math Algorithm option. This calculates and displays the total flow volume being measured by Input 1. Alternatively, it can be applied to either Input Algorithm 1 or Input Algorithm 2 to totalize the compensated flow rate being calculated by the algorithm.

The **totalizer displays** the current totalized flow value (up to seven digits maximum). Seven **scaling factors** are available (from one to one million). The desired scaling factor is applied to the calculated value to extend the maximum total flow range that can be displayed.

Five integration rates are available to match the totalizer rate to the rate of flow being measured. The rates are:

```
Engineering units (EU) per second
EU per minute
EU per hour
EU per day
Millions of units per day
```

The totalizer value is stored in nonvolatile memory once every eight hours. If **power is lost** while the totalizer is in operation, the current value of the totalizer will be lost. When **power is restored**, the totalizer will start operation for the last value stored in nonvolatile memory. The Σ (**Sigma**) display will blink to indicate this condition. Reset the totalizer.

The totalizer can be **reset** from the keyboard whenever desired. The totalizer should always be reset to initialize the counters whenever it is enabled, otherwise, the " Σ " (Sigma) display will blink.

Refer to *Section 3 – Configuration*, Set Up group ALGORITHM, function prompt TOTALIZER to select an application, and the function prompts that follow TOTALIZER to enter your scale factor and rate of integration.

Alarm on totalizer value

The alarm type configuration includes an Alarm on Totalizer value. This allows an alarm setpoint value to be used to cause an alarm when exceeded. The alarm setpoint represents the lowest four digits of the selected Totalizer Scale Factor and has a range from 0 to 9999 x Totalizer Scale Factor.

Totalizer reset via digital input

The digital input type configuration includes a Reset Totalizer that resets the accumulated totalizer value when the DI is closed.

5.18 Digital Input Option (Remote Switching)

Introduction

The Digital Input option detects the state of external contacts for either of two inputs. On contact closure, the controller will respond according to how each digital input is configured. If the controller is configured for either 2-loop or Cascade control, then switch #1 operates only on Loop 1 and switch #2 operates only on Loop 2.


Make your selection under the Option Set Up group function prompt “DIG IN1” or “DIG IN2.” See *Section 3 – Configuration* .

Action on closure

Table 5-30 lists the configuration prompt selections, the “Action on Closure,” and the display indication for each selection available.

Table 5-30 Digital Input Option Action on Contact Closure

DIG IN1 or DIG IN2 Selections	Display Indication	Action on Contact Closure Returns (toggles) to original state when contact opens, unless otherwise noted.
None	DI 1 2 always off*	No Digital Input selection <i>*The Digital Input Annunciator will always show the Digital Input status.</i>
TO MAN	MAN blinks	Puts the controller into manual mode. Contact open returns the controller to former mode unless MANUAL/AUTO key is pressed while digital input is active, then it stays in the manual mode.
TO LSP		Puts the controller into local setpoint 1. When contact opens, the controller returns to former operation, local or remote setpoint, unless the SETPOINT SELECT key is pressed while digital input is active, then it stays in the local setpoint mode.
TO 2SP	RSP annunciator blinks	Puts the controller into local setpoint 2. When contact opens, the controller returns to former operation, local or remote setpoint, unless the SETPOINT SELECT key is pressed while digital input is active, then it stays in the local setpoint 2 mode.
TO 3SP	RSP annunciator blinks	Puts the controller into local setpoint 3. When contact opens, the controller returns to former operation, local or remote setpoint, unless the SETPOINT SELECT key is pressed while digital input is active, then it stays in the local setpoint 3 mode.
TO DIR		Selects direct controller action.
ToHOLD	H blinks	Suspends setpoint program or setpoint ramp operation. Contact open runs the ramp/program from the Hold point unless the Ramp/Program was not previously started via the RUN/HOLD key. This selection applies to either loop.
ToPID2	PIDSET 2 in lower display	Selects PID set 2.
PV 2IN	II IN (II blinks)	Selects the PV to equal Input 2.
PV 3IN	III IN (III blinks)	Selects the PV to equal Input 3.
RERUN		Resets the Setpoint program back to the beginning of the first segment in the program and leaves the program in the same Run or Hold mode that it was in when the DI closed. Opening the DI has no further affect.

DIG IN1 or DIG IN2 Selections	Display Indication	Action on Contact Closure Returns (toggles) to original state when contact opens, unless otherwise noted.
TO RUN	R indicator blinks	Starts a stopped SP Program. Reopening contact puts the controller in Hold mode. This selection applies to either loop.
ToBEGN		Resets the Setpoint Program back to the beginning of the first segment in the program and places the program into the Hold mode. Reopening the contact has no effect. This selection applies to either loop.
STOP I		Disables PID Integral (I) action.
MAN FS	MAN blinks	Unit goes to manual mode, output goes to the failsafe value. This will cause a bump in the output when switching from AUTO to MANUAL. The switch back from MANUAL to AUTO is bumpless.
ToLOCK	LOCKED when a key is pressed	Disables all keys.
ToAout		Output is forced to value set at control prompt "AUTO OUT" when controller is in automatic mode. Reopening contact returns the controller to the normal output. This selection is only available on Loop 1.
TIMER	Timer clock () and time appear in lower display.	Starts timer (momentary). Reopening switch has no effect.
AM STA		Causes switch to Auto Manual Station mode. Refer to <i>Figure 5-5 in Section 5.19</i> for auto manual station information. This selection is only available on Loop 1.
ToTUNE	TUNE ON in lower display	Starts the Accutune process. Opening the switch has no effect.
SPinit		Forces the SP to initialize at the current PV value.
TRACK1	O blinks	Allows Output 1 to track Input 2.
TRACK2	O blinks	Allows Output 2 to track Input 2.
ToOUT2	O blinks	Allows Output 2 to override Output 1.
TO RSP	RSP annunciator blinks	Selects remote setpoint.
D L1/2		Displays loop not being displayed at time of closure.
RST FB		Allows Input 2 to override the internal reset value, providing external reset feedback.
ToPURG	MAN blinks and output value shows in lower display	Forces loop to manual mode with the output values set to the Output High Limit configuration.
LoFIRE	MAN blinks and output value shows in lower display	Forces loop to manual mode with the output set to the Output Low Limit configuration.
MAN LT		Forces loop to manual mode. This is a momentary switch input, therefore no action occurs when the switch is opened. To return to automatic mode, press the MANUAL/AUTO key.
REStot		Resets the accumulated totalizer value. Opening the switch has no effect.

Keyboard operation Front panel keys have no effect on the digital input action in the closed state.

Digital inputs 1 and 2 combination selections The Digital Input combination selections listed in Table 5-31 can be used in combination with the digital inputs 1 and 2 listed in Table 5-30. Refer to *Section 3 – Configuration* and make your selections under the Options Set Up group function prompt “DIG 1 COMB” or “DIG 2 COMB.”

When 2-loop or cascade control is configured, digital input 1 operates on Loop 1 and digital input 2 operates on Loop 2, unless otherwise noted.

Table 5-31 Digital Input Combinations “DIG IN1” or “DIG IN2”

Selections used in Combination with “DIG IN1” or “DIG IN2”	Display Indication	Action on contact closure Returns (toggles) to original state when contact opens.
+PID2	PIDSET 2 in lower display	Selects PID set 2.
+ToDIR		Puts the controller into direct controller action.
+ToSP2	RSP blinks	Selects the second local setpoint.
+DISAT	T indicator is no longer lit	Disables Adaptive tune.
+ToSP1		Selects the local setpoint.
+RUN	R indicator blinks	Starts or restarts RUN of SP Ramp/Program.

Digital inputs 1 and 2 combination operation There are five possible situations that can occur when working with digital input combinations. Table 5-32 lists these situations and the resulting action when the switch is active.

In the table:

Enabled means that the parameter is configured and the action will occur when the digital input is active.

Action Disabled means that the digital input or digital combination parameter is configured but the action cannot occur when the digital input is active because the selected parameter is disabled.

Table 5-32 Digital Inputs 1 and 2 Combination

DIG IN1	DIG COMB	Action	Example
NONE	Any Selection	No action will occur when the digital input is active.	
ENABLED	DISABLED	The DIG IN condition will occur when the Digital Input is active.	DIG IN1 = TO MAN DIG1 COM = DISABL Loop 1 will switch to MANUAL when digital input 1 is active.
ACTION DISABLED	ENABLED	No action will occur when the digital input is active.	DIG IN1 = ToPID2 PID SETS = 1 ONLY DIG1 COM = +ToSP2 LSP'S = TWO DIG IN1 is action disabled because PID SETS is set to 1 ONLY. Therefore, when digital input 1 is active, no action will occur even though DIG1 COM is enabled.
ENABLED	ACTION DISABLED	Action is indeterminate when the digital input is active.	DIG IN1 = ToPID2 PID SETS = 2KEYBD DIG1 COM = +ToSP2 LSP'S =1 ONLY Because DIG1 COM is action disabled, the action will be indeterminate when DIG IN1 is active.
ENABLED	ENABLED	Both DIG IN and DIG COM action will occur.	

5.19 Auto/Manual Station

Introduction

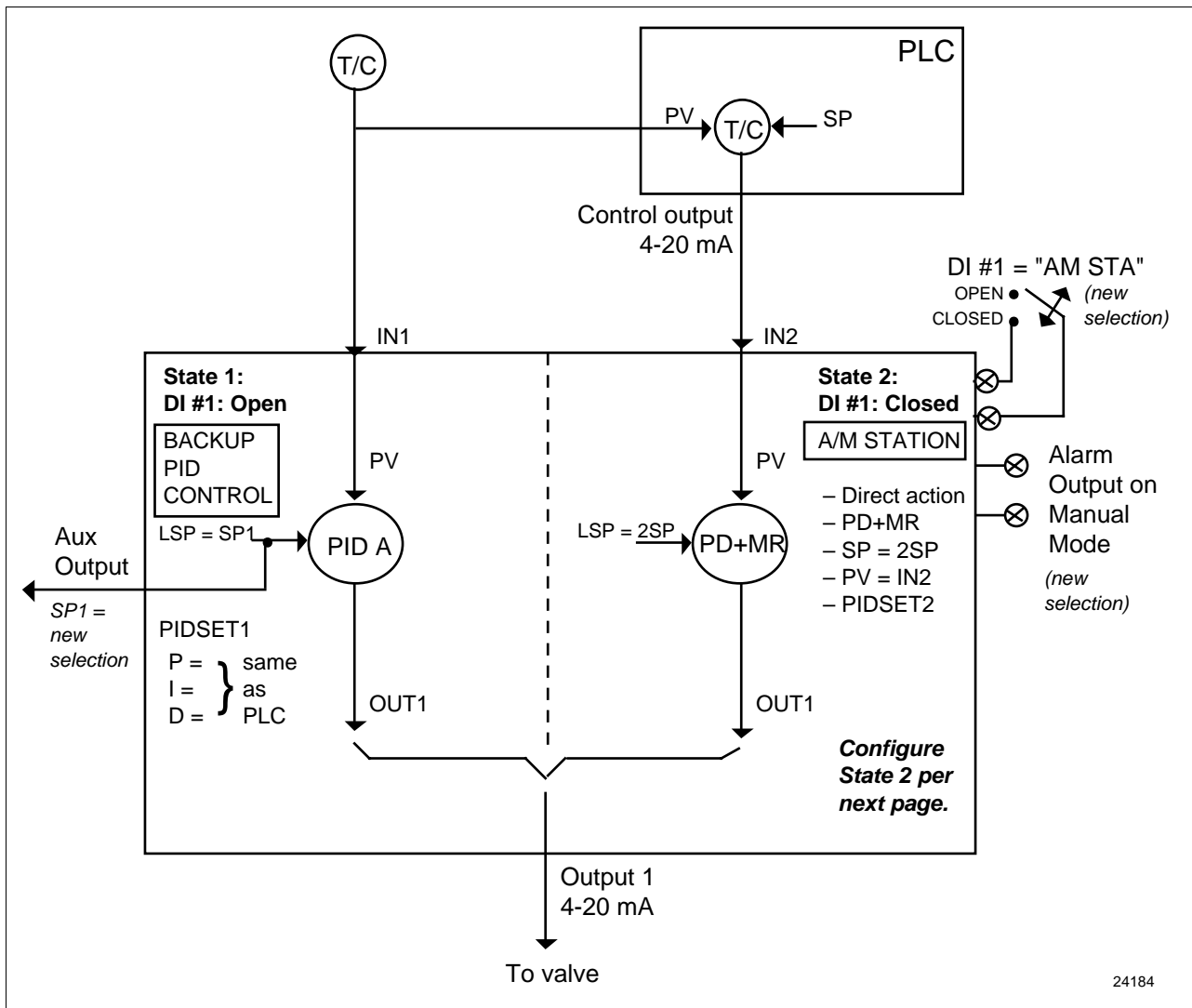
When you select "AM STA" (auto manual station) under the Option Set Up group function prompt "DIG IN1" or "DIG IN2" (digital input option), contact closure on the selected digital input causes the controller to switch to Auto/Manual Station mode.

Function

As shown in Figure 5-5, State 2 is the "A/M Station mode" where the programmable logic controller (PLC) output is sent through the Auto/Manual Station. You can switch to manual and change the output at the controller. (It uses PID set 2.)

State 1 is the "Backup PID mode" which is triggered by opening the digital input. (It uses PID set 1.)

Figure 5-5 Auto/Manual Station and Backup Control Feature



Description

The “AM STA” selection of digital input creates a repeater station when the digital input is closed. This is accomplished by a multi-selection from the digital input menu.

- “ACTION” is forced as “DIRECT”.
- “CONT ALG” is forced as “PD+MR”.
- Active setpoint is forced to 2SP.
- The PV is switched to “PV 2IN”.
- The tuning parameters used are the second set of parameters.

When the switch is open the unit becomes a normal controller with “CONT ALG” of “PID A”, using tuning parameters set 1, SP, PV as IN1 and “DIRECT” or “REVERSE” as selected by customer configuration.

Input 1 is typically the PV of some upper controller and Input 2 is typically that controller’s output. If the upper control fails, the upper device or some watchdog opens the digital input switch and UDC 3300 back-up PID A control is active.

When the upper control reactivates, the digital input switch is closed and the Auto/Manual Station becomes a repeater station and allows the upper control output signal to pass through.

Configuration

There are some things to consider when configuring the controller.



The PV range stays as the IN1 range, even while IN2 is the PV when the switch is closed; therefore:





- The IN2 HI must be less than or equal to the IN1 HI.
(Suggest: $IN2\ HI = 100.0$)
- The IN2 LO must be greater than or equal to the IN1 LO.
(Suggest: $IN2\ LO = 0.0$)
- The TUNING GAIN2 must be equal to $(IN1\ HI - IN1\ LO) / (IN2\ HI - IN2\ LO)$.

Configuration

Refer to Table 5-33 and set up the controller in the order shown.

Table 5-33 Auto/Manual Station Mode Configuration Procedure

Step	Press  to Select Set Up Group	Press  to Select Function Prompts	Press ▲ ▼ to Enter Value or Selection	Remarks
1	Control	PID SETS	2KEYBD	Select other control parameters as needed by the application.
		LSP'S	TWO	
		SP TRACK	NONE	
2	Algorithm	CONT ALG	PD+MR	This allows setting of the Manual Reset value.
3	Tuning	MAN RSET	0	Manual reset of 0 for no output bias and requires LSP2 = 0 %. If bias is required, set MR to equal the desired output bias value.

Step	Press  to Select Set Up Group	Press  to Select Function Prompts	Press   to Enter Value or Selection	Remarks
4	Algorithm	CONT ALG	PID A	Defines back-up control algorithm.
5	Tuning	RSET2MIN	50.00	Note 1. Set the Gain 2 equal to $\frac{\text{Input 1 Span}}{\text{Input 2 Span}}$ If "PB" is selected under the Control Set Up group function prompt "PBorGAIN", set the PROP BD2 to $100 \times \frac{\text{Input 2 Span}}{\text{Input 1 Span}}$
		GAIN2	See Note 1	
		RATE2MIN	0.00	
6	Options	DIG IN1 or DIG IN2	AM STA	

CAUTION

DO NOT SELECT

- In the CONTROL set up list, do not select SP TRACK as PV or RSP.
- In the SP RAMP set up list, do not select SP RATE as ENABLE.
- In the ALGORITHM set up list, do not select CONT ALG as PID B, ON-OFF, or 3PSTEP.
- In the Display menu when PIDSET # is displayed, DO NOT change the selection.

Operation

Set the local setpoint 2 to 0 % of the Input 2 range.

These features work with the Auto/Manual Station.

- In the SP RAMP set up list, SP PROG (acts on SP1 for backup operation).
- In the SP RAMP set up list, SP RAMP (acts on SP1 for backup operation).
- In the CONTROL set up list, ACTION as DIRECT or REVERSE for the backup PID A operation.

The PD+MR action is forced to be DIRECT as required for the pass through of the output signal.

5.20 Fuzzy Overshoot Suppression

- Introduction** Fuzzy Overshoot Suppression minimizes overshoot after a setpoint change or a process disturbance. This is especially useful in processes which experience load changes or where even a small overshoot beyond the setpoint may result in damage or lost product.
- How it works** The fuzzy logic observes the speed and direction of the PV signal as it approaches the setpoint and temporarily modifies the internal controller response action as necessary to avoid an overshoot. There is no change to the PID algorithm, and the fuzzy logic does not alter the PID tuning parameters. This feature can be independently enabled or disabled, as required by the application, to work with TUNE On-Demand tuning, the SP tuning algorithm, or Adaptive Tune.
- Configuration** To configure this item, refer to *Section 3 – Configuration*:
- Set Up Group **ACCUTUNE**
 - Function Prompt **FUZZY**
 - Select **ENABLE** or **DISABL** (▲ or ▼)

5.21 Accutune

Introduction

There are several types of Accutune from which to choose:

- **(TUNE) Demand Tuning**—Tuning is done on demand
 - by pressing the **LOWER DISPLAY** and **▲** keys simultaneously,
 - by selecting prompt “TUNE” in the lower display,
 - via digital input.
- **(SP) Setpoint Tuning***—SP only tuning will continually adjust the Gain or Proportional Band (P), Reset (I), and Rate (D) tuning constants in response to setpoint changes.
- **(TUN+PV) Demand Tuning + PV Adapt**—Provides TUNE On Demand tuning plus PV adaptive tuning whenever a PV process disturbance of 0.3 % span or greater occurs.
- **(SP+PV) Setpoint Tuning* + PV Adapt**—Provides SP only tuning plus PV adaptive tuning whenever a PV process disturbance of 0.3 % span or greater occurs.

*Not available on Basic Model DC330B

Configuration

To configure this item, refer to *Section 3 – Configuration*:

- Set Up Group **ACCUTUNE**.
- Function Prompt **ACCUTUNE** or **ACCUTUN2** depending on which loop you are tuning.
- Select **DISABL**, **TUNE**, **SP**, **TUN+PV**, or **SP+PV**. Use the **▲** or **▼** key.

If **SP** is selected:

- Enter the setpoint change value, function prompt **SP CHANG** or **SP CHAN2**.
- Verify or change the process gain value, function prompt **KPG** or **KPG 2**.
- Verify criteria, function prompt **CRITERIA** or **CRITERA2**.

Two-loop and cascade operation

Accutune can be used on either or both loops. However, while one loop is operating by **SP** tuning, the configuration of either loop cannot be changed. When one loop is operating by **PV** adaptive tuning, the other loop can have its configuration changed.

Rules

Table 5-34 is a list of rules for Accutune.

Table 5-34 Accutune Rules and Regulations

TUNE	SP*	Applicable Rule
X		TUNE On Demand tuning will work for all control algorithms except ON/OFF. Process line out is not required.
X		TUNE On Demand tuning works for integrating processes.
	X	SP tuning will work only for algorithm PID a or PID B selections; i.e., it will NOT work with ON/OFF, Three Position Step, or PD+MR control algorithms.
	X	SP tuning can tune on all local or computer setpoints <i>except ramping setpoints</i> ; i.e., cannot be done during SP Ramp or SP Program or when using remote setpoint.
X	X	Tuning is done in automatic mode.
X	X	Tuning can be monitored or reconfigured using communications option.
X	X	Tuning can be enabled via digital inputs.
X	X	Tuning can be aborted by going to manual mode or disabling via configuration.
X	X	When tuning is in progress, a large T appears in the upper display and disappears as soon as tuning is completed.
X	X	Can tune two independent loops.
X		Setpoint changes can be made during operation. The setpoint at the time tuning starts is captured and Tune runs until completion, then proceeds to the new SP value following the completion of tuning.

*SP ADAPT not available on Basic Model DC330B

How TUNE (demand) tuning works

TUNE tuning provides virtually foolproof, trouble-free on-demand tuning in the UDC 3300 controller. No knowledge of the process is required at start-up. The operator simply enters the desired setpoint and initiates the tuning.

The controller immediately starts controlling to the setpoint while it identifies the process, calculates the tuning constants and enters them into the Tuning group, and begins PID control with the correct tuning parameters. This works with any process, including integrating type processes, and allows returning at a fixed setpoint.

The tuning sequence will cycle the controller's output two full cycles between 0 % and 100 % (or configured output limits) while allowing only a very small process variable change above and below the SP during each cycle. The algorithm then calculates new tuning parameters and enters them into the Tuning group. A large **T** appears in the upper display while tuning is active.

Starting TUNE (demand) tuning

After TUNE or TUN+PV has been enabled, use the procedure in Table 5-35 to start tuning.

Table 5-35 Procedure for Starting TUNE (Demand) Tuning

Step	Action
1	Set the setpoint to the desired value.
2	Switch to Automatic mode by pressing the MANUAL/AUTO key.
3	Initiate Tuning by: <ul style="list-style-type: none">• pressing the ▲ key when the lower display prompt = TUNE-OFF,• pressing the LOWER DISPLAY and ▲ keys simultaneously, or• using the digital input, if configured.

Aborting tuning

If it is necessary to stop or abort the tuning process, press the **MANUAL/AUTO** key and the controller will return to manual mode. You can also disable TUNE or TUN+PV in the ACCUTUNE or ACCUTUN2 Set Up group.

TUNE for duplex (heat/cool)

TUNE can be done for applications using duplex (heat/cool) control. During tuning, Accutune requires that **setpoint 1** will cause a Heating demand, and then the calculated tuning parameters will be automatically entered as PID set 1. Likewise, it requires that tuning at local **setpoint 2** will cause a Cooling demand, and then the cooling parameters will be entered as PID set 2.

The tuning sequence will cycle the controller's output two full cycles between the high output limit and 50 % for HEAT or between 50 % and the low output limit for COOL while allowing only a small process variable change above and below the setpoint during each cycle.

Configuring TUNE for duplex (heat/cool)

To configure this item, refer to *Section 3 – Configuration*:

- Set Up Group **ACCUTUNE**
- Function Prompt **ACCUTUNE** or **ACCUTUN2**
- Select **TUNE** or **TUN+PV**, using either **▲** or **▼**.

Using TUNE at start-up for duplex (heat/cool) After TUNE or TUN+PV has been enabled, use the procedure in Table 5-36 to use TUNE at start-up for duplex (heat/cool) control.

Table 5-36 Procedure for Using TUNE at Start-up for Duplex

Step	Action
1	<p>Heat Zone:</p> <ul style="list-style-type: none"> • Adjust Local Setpoint 1 to a value within the Heat zone. • Put the controller in <i>Automatic</i> mode. • Press the LOWER DISPLAY and ▲ keys simultaneously to initiate Heat tuning. <p>The output will cycle between 50 % and 100 % (or high output limit). A large T appears in the upper display until tuning is completed and final Heat parameters are entered for PID set 1 in the Tuning group.</p>
2	<p>Cool Zone:</p> <ul style="list-style-type: none"> • Adjust Local Setpoint 2 to a value within the Cool zone. • Put the controller in <i>Automatic</i> mode. • Press the LOWER DISPLAY and ▲ keys simultaneously to initiate Cool tuning. <p>The output will cycle between 0 % and 50 % (or low output limit). A large T appears in the upper display until tuning is completed and final Cool parameters are entered for PID set 2 in the Tuning group.</p>

How SP tuning works SP tuning will continually adjust the Gain or Proportional Band (P), Reset (I), and Rate (D) tuning constants in response to setpoint changes.

ATTENTION SP tuning is not available on Basic Model DC330B.

SP tuning handles all Local and Computer setpoint changes. It uses time domain analysis, and the rule based expert system techniques to identify the two most dominant process lags plus any dead time. It then automatically readjusts the PID parameters as necessary. It does this while controlling to setpoint in automatic (closed loop) control mode.

These calculated PID values can be changed, if desired, whenever the tuning is not active. Tuning can be aborted by pushing the **MANUAL/AUTO** key to return to the manual mode.

Two criteria are available—Normal and Fast—through configuration.

Setpoint changes During start-up, or whenever the setpoint changes beyond the “SP Change” value, SP tuning employs time domain analysis to tune the process at any desired setpoint without any prior initialization or process knowledge.

Using SP tuning at start-up

After SP or PV+PV has been enabled, use the procedure in Table 5-37 to use SP tuning at start-up.

Table 5-37 Procedure for Using SP Tuning at Start-up

Step	Action
1	Put the controller in manual mode by pressing the MANUAL/AUTO key.
2	Let the PV stabilize.
3	Adjust the setpoint to the desired value.
4	Put the controller in automatic mode by pressing the MANUAL/AUTO key. The controller will switch to automatic mode and the process will start to move toward the setpoint and will line out with the proper tuning constants. A large T appears on the left side of the upper display to indicate that SP tuning is in progress.

SP tuning for duplex (heat/cool)

SP tuning can be done for applications using duplex (heat/cool) control.

Configuring SP tuning for duplex (heat/cool)

To configure this item, refer to *Section 3 – Configuration*:

- Set Up Group **ACCUTUNE**
- Function Prompt **ACCUTUNE** or **ACCUTUN2**
- Select **SP** or **SP+PV**, using either **▲** or **▼**.
- Enter the Setpoint Change Value, Function Prompt **SP CHANG** or **SP CHAN2**.
 - Verify the Process Gain Value to be 1.0, Function Prompt **KPG** or **KPG 2**.
 - Verify Criteria selected is FAST, Function Prompt **CRITERIA** or **CRITERA2**.

Using SP tuning at start-up for duplex (heat/cool)

After SP or SP+PV has been enabled, use the procedure in Table 5-38 to use SP tuning at start-up for duplex (heat/cool) control.

Table 5-38 Procedure for Using SP Tuning at Start-up for Duplex

Step	Action
1	Put the controller into manual mode— MANUAL/AUTO key.
2	<p>Heat Zone:</p> <ul style="list-style-type: none"> Adjust the Output to a value above 50 % and at least 5 % lower than the normal heating setpoint value. Let the PV stabilize. Press the MANUAL/AUTO key to start tuning for Heat zone. <p>The controller will switch to automatic mode and the process will start to move toward the setpoint and will line out with the proper Heat tuning constants. A large T appears on the left side of the upper display to indicate that SP tuning is in progress.</p> <p>When the T disappears, tuning is completed and final values are entered for PID set 1 parameters in the Tuning group.</p>
3	<p>Cool Zone:</p> <ul style="list-style-type: none"> Adjust the Output to a value below 50 % and at least 5 % above the normal cooling setpoint value. Let the PV stabilize. Press the MANUAL/AUTO key to start tuning for Cool zone. <p>The controller will switch to automatic mode and the process will start to move toward the setpoint and will line out with the proper Cool tuning constants. A large T appears on the left side of the upper display to indicate that SP tuning is in progress.</p> <p>When the T disappears, tuning is completed and final values are entered for PID set 2 parameters in the Tuning group.</p>

SP tuning after start-up SP tuning will occur whenever the controller is in automatic mode and a setpoint change occurs which is greater than the previously configured minimum setpoint change value.

The controller will delay using any setpoint changes for 30 seconds to enable it to calculate whether to SP tune or not. But if the controller is toggled between LSP1 and LSP2 or if any other key (such as LOWER DISPLAY) is pressed, the setpoint change is immediate.

A large **T** is displayed in the upper display whenever tuning is in progress. During this time, no changes to the configuration parameters, including the setpoint, are permitted.

Aborting SP tuning

If it is necessary to stop or abort the tuning:

- Press the **MANUAL/AUTO** key to return to manual mode. This will cause an immediate abort of tuning.
- Disable SP or SP+PV in the Accutune Set Up group at function prompt ACCUTUNE or ACCUTUN2.

Retuning

The controller will evaluate current tuning as SP changes occur. When retuning is required, the controller operates in automatic mode and identifies new tuning constants. At the point, the **T** appears and tuning values are entered and used until retuning occurs again.

TUN+PV or SP+PV (process variable disturbance)

The TUNE demand tuning or the SP tuning portions of these selections work as stated previously.

During process variable (PV) disturbances which result from nonlinearities, process dynamics, load changes, or other operating conditions, PV adapt tuning will occur whenever a PV disturbance of 0.3 % span or larger occurs. When this condition exists, the controller monitors the process response to determine whether there has been a true process change or a momentary upset. It will take 1 and 1/2 process cycles around the setpoint before any process recognition can occur to an oscillating process.

However, if no oscillation occurs, Adaptive may alter the parameters to speed up or slow down the process response, if it determines the time to return to the SP is excessive or too fast (overshoot occurs).

For this configuration, the controller operates with only one set of tuning parameters for each loop. The second set, normally used for duplex output or for keyboard, PV or SP switching, is not used because Adaptive tune continually updates the tuning parameters based on the PV deviation.

PV tuning indications

A small **t** is displayed in the upper display whenever PV adapt mode is in progress. During this time, changes to the configuration parameters are permitted. Whenever the **t** is displayed it signifies that the process response is being monitored and this may or may not result in parameter retuning.

The selection of Fast or Normal criteria has no effect on PV adaptive tuning.

Aborting PV adaptive tuning

If it is necessary to stop or abort the tuning:

- Press the **MANUAL/AUTO** key to return to manual mode. This will cause an immediate abort of tuning.
- Disable TUN+PV or SP+PV in the Accutune Set Up group at function prompt ACCUTUNE or ACCUTUN2.

Error prompt accessing procedure

When an error is detected in the Accutune process, the message **AT ABORT** will appear in the lower display.

In order to determine what is causing the error:

- Select **ACCUTUNE** or **ACCUTUN2** Set Up Group.
- Access Function Prompt **AT ERROR** or **AT ERR 2** for error prompt.

Error prompt

Table 5-39 lists the Accutune error prompts and their definitions.

Table 5-39 Accutune* Error Prompt Definitions

Upper Display Prompt	Prompt Definition	Action to Take
NONE	No errors	None
OUTLIM	SP Adapt step is greater than high output limit or less than low output limit Output step insufficient to get to SP value	<ul style="list-style-type: none"> • Check the output limits under Control Set Up group function prompts OUTHiLIM and OUTLoLIM in <i>Section 3 – Configuration</i>. • Verify the Process Gain Value, function prompt KPG or KPG 2.
IDFAIL	Process Identification Failure An illegal value of gain, rate, or reset was calculated.	Try to SP tune again. Insure the process is at line-out prior to initiation of SP tune.
ABORT (Only error code available for TUNE)	<ul style="list-style-type: none"> • Manual abort has occurred <ul style="list-style-type: none"> – Accutune will abort if the MANUAL/AUTO key is pressed during tuning • Digital input detected • Automatic abort has occurred <ul style="list-style-type: none"> – Accutune will automatically abort when a PV oscillation has been detected during SP adapt, whenever any SP values are changed during a PV adapt tune, or when Accutune is disabled. 	Try to TUNE or SP tune again.
LOW PV	PV not changed sufficiently or the PV has increased by more than 4 % and dead time not determined.	NONE—After a period of about five minutes, the SP adaptive tuning will be retried automatically with a larger output step.
RUNING	Informational prompt indicating that SP tune is still active checking process gain even though T is not lit. It does not affect the keyboard operation.	NONE

*Does not apply to PV Adapt.

5.22 Carbon Potential

Introduction

Figure 5-6 shows a UDC 3300 controller being used to control the carbon potential of a furnace's atmosphere. A carbon probe consisting of a ZrO₂ sensor and a thermocouple (to measure the temperature at the sensor) provides two inputs to the controller. The microprocessor-based controller computes the atmosphere's actual carbon potential from these two inputs and compares the computed value with the desired setpoint. As an on-off or PID control algorithm determines the controller output necessary to keep the actual carbon potential at the setpoint. Usually only one output is used to add more or less enriching gas (typically natural gas) to the furnace's base atmosphere, which has a relatively low carbon potential.

The enriching gas then raises the carbon potential to the desired level; however, there are occasions when it is necessary to add dilution air to lower the carbon potential instead of enriching gas to raise it. In those instances, a second output from the controller provides this function. When proportional control is used, a different set of PID tuning constants is used for the dilution air than those used for the enriching gas.

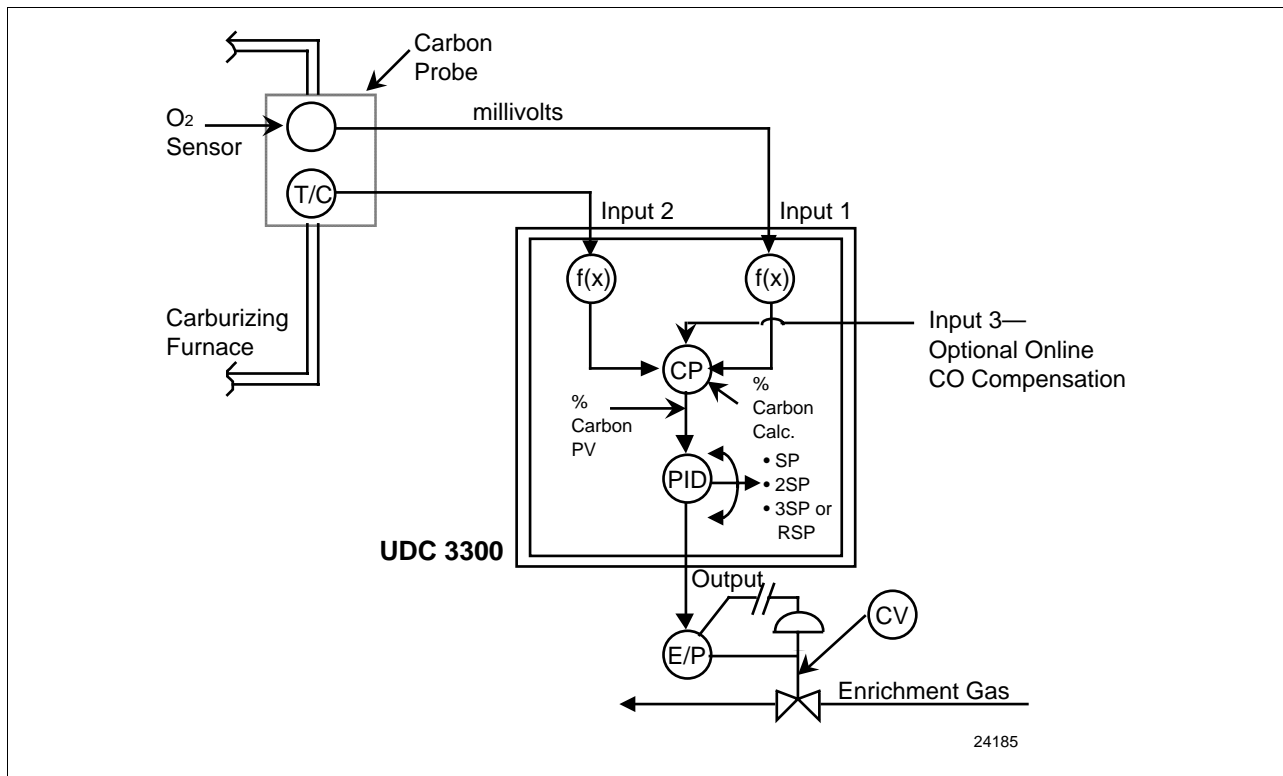
Features

- Direct calculation of carbon percentage with seven different manufacturers' probes
 - Advanced Atmosphere Control Corporation (AACC)
 - Corning
 - Cambridge Instruments
 - Marathon Monitors
 - Furnace Control Corporation
 - MacDhui (Barber Colman)
 - Bricesco
- ± 0.02 % accuracy
- No nomographs—no mistakes
- Two controller outputs are available for duplex control.
- Probe temperature input type is selectable from complete input menu.
- Three different local setpoints—standard feature
- Duplex control with second set of PID constants for dilution air control
- Process factor adjustment capability
- Automatic sooting warning via flashing display
- New Dewpoint algorithm is available. Range: -50 °F to +100 °F
- New % Oxygen algorithm is available. Range: 0 % to 40 %

Diagram

Figure 5-6 is a diagram illustrating the application of the UDC 3300 for carbon potential control.

Figure 5-6 Carbon Potential Control



ATTENTION

- For Carbon control, set Input Algorithm 1 to the proper carbon sensor used and set the PV source to IN AL 1. Input 1 will automatically become CARBON.
- For % Oxygen control, set Input Algorithm 1 to OXYGEN. Input 1 will automatically become OXYGEN.
- For Dewpoint control, set Input Algorithm 1 or Input Algorithm 2 to DEW PT. Input 1 will automatically become CARBON. The availability of Dewpoint on Input Algorithm 2 provides the capability of controlling Carbon Potential on Loop 1 and also reading the Dewpoint value from the same probe.
- CO Compensation—Receives external CO transmitter signal via Input 3 to provide online compensation fo the carbon calculation. Requires that the Input 2 temperature signal be a transmitter type input.

5.23 HealthWatch

Introduction

The HealthWatch feature puts diagnostic data at your fingertips so you can monitor vital performance status to improve your process, predict failures, and minimize downtime.

Valuable data regarding maintenance and diagnostic selections can be read by operator-accessed displays. Alarms can be configured to activate when the desired threshold is reached.

See *Section 4.18 Maintenance* for details on using the various HealthWatch timers and counters. See *Section 4.15 Alarms* for details on HealthWatch maintenance alarms.

Section 6 – Setpoint Ramp/Soak Programming Option

6.1 Overview

What is programming? The term “programming” is used here to identify the process for selecting and entering the individual ramp and soak segment data needed to generate the required setpoint versus time profile (also called a program).

A segment is a ramp or soak function which together make up a setpoint program. Setpoint Ramp/Soak Programming lets you configure 6 ramp and 6 soak segments to be stored for use as one program or several small programs. You designate the beginning and end segments to determine where the program is to start and stop.

Review program data and configuration While the procedure for programming is straightforward, and aided by prompts, we suggest that you read “*Program Contents*” in this section as well as “*Section 3 - Configuration*” before doing the setpoint programming.

Fill out the worksheet Draw a Ramp/Soak Profile on the worksheet provided and fill in the information for each segment. This will give you a record of how the program was developed.

What’s in this section The table below lists the topics that are covered in this section.

	Topic	See Page
6.1	Overview	205
6.2	Program Contents	206
6.3	Drawing a Ramp/Soak Profile	209
6.4	Entering the Setpoint Program Data	211
6.5	Run/Monitor the Program	214

6.2 Program Contents

What you will configure Basically, you will configure all the data that is relevant to each ramp and soak segment for a given setpoint versus time profile. The controller will prompt you through the sequence of segments and associated functions.

Ramp segments A ramp segment is the time it will take to change the setpoint to the next setpoint value in the program.

Ramps are odd number segments. Segment #1 will be the initial ramp time.

Ramp time is determined in either:

TIME* - Hours.Minutes Range = 0-99hr.59 min.

or

RATE* - EU/MIN or EU/HR Range = 0 to 999

* This selection of time or rate is made at prompt "RAMP UNIT".

Set this prompt before entering any Ramp.

ATTENTION Entering "0" will imply an immediate step change in setpoint to the next soak.

Soak segments A soak segment is a combination of soak setpoint (value) and a soak duration (time).

Soaks are even number segments.

Segment 2 will be the initial soak value and soak time.

The soak setpoint range value must be within the setpoint high and low range limits in engineering units.

SOAK TIME is the duration of the soak and is determined in:

TIME - Hours.Minutes RANGE = 0-99hr.59 min.

Start segment number This designates the number of the first segment (odd number).
Range = 1 to 11

End segment number This designates the number of the last segment. It must be a soak segment (even number).
Range = 2 to 12

Recycle number This number allows the program to recycle a specified number of times from beginning to end.
Range = 0 to 99

Guaranteed soak

Each soak segment can have a deviation value of from 0 to ± 99 which guarantees the value for that segment.

Guaranteed soak segment values >0 guarantee that the segments process variable is within the \pm deviation for the configured soak time. Whenever the \pm deviation is exceeded, soak timing is frozen.

There are no guaranteed soaks whenever the deviation value is configured to 0; i.e., soak segments start timing soak duration as soon as the soak setpoint is first reached, regardless of where the process variable remains relative to the soak segment.

The value is the number in engineering units, above or below the setpoint, outside of which the timer halts. The range is 0 to 99.

The decimal location corresponds to input 1 decimal selection.

Program state

This selection determines the program state after completion.

The selections are:

DISABL = Program is disabled

HOLD = Program on hold (RUN key restarts the program.)

Program termination state

This function determines the status of the controller upon completion.

The selections are:

LASTSP = controls to last setpoint and last control mode

F SAFE = manual mode, failsafe output

ATTENTION If power is lost during a program, upon power-up the controller will be in hold and the setpoint value will be the setpoint value prior to the beginning of the setpoint program. The program is placed in hold at the beginning of the first segment in the program.

Hot Start

This function determines whether LSP1 or PV is used as the setpoint when the program is initially changed from HOLD to RUN.

The selections are:

DISABL = When the program is initially changed from HOLD to RUN the present LSP1 value is captured as the default setpoint. If the program is terminated or the power cycled before the program has completed, the LSP1 is used as the control setpoint. The beginning segment uses this value as the initial ramp setpoint.

ENABL = When the program is initially changed from HOLD to RUN the present PV value is captured and used as the beginning setpoint value for the ramp segment. If the program is terminated before completion, the setpoint value will revert back to the PV value captured at the initial HOLD to RUN transition. If the power is cycled before program completion, upon power-up the setpoint is set to the PV value at power-up and when the program is restarted that setpoint value is used initially.

Ramp unit

This determines the engineering units for the ramp segments.

The selections are:

TIME = Hours.Minutes

RATE = EU/MIN or EU/HR

ATTENTION This selection cannot be changed while a program is in operation.

ATTENTION

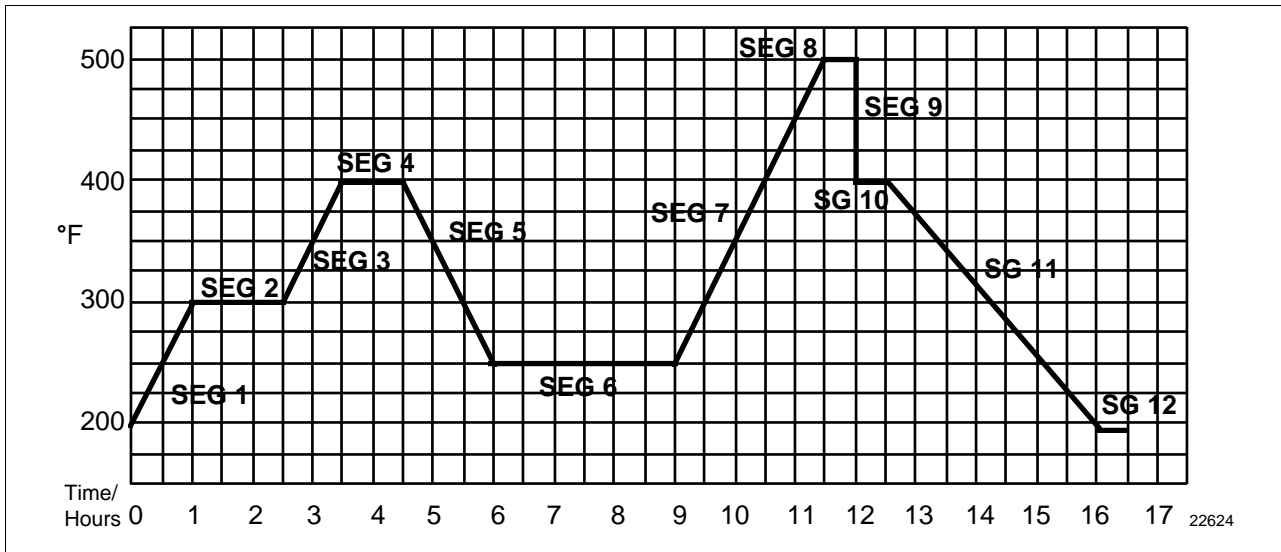
The Accutune **TUNE** selection will operate during setpoint programming. When it is initiated during a program, it places the program into Hold until it completes, then returns it to either Run or Hold depending what the state was before Tuning started.

6.3 Drawing a Ramp/Soak Profile

Ramp/Soak Profile example

Before you do the actual configuration, we recommend that you draw a Ramp/Soak profile in the space provided on the “*Program Record Sheet*” (Figure 6-2) and fill in the associated information. An example of a Ramp/Soak Profile is shown in Figure 6-1.

Figure 6-1 Ramp/Soak Profile Example

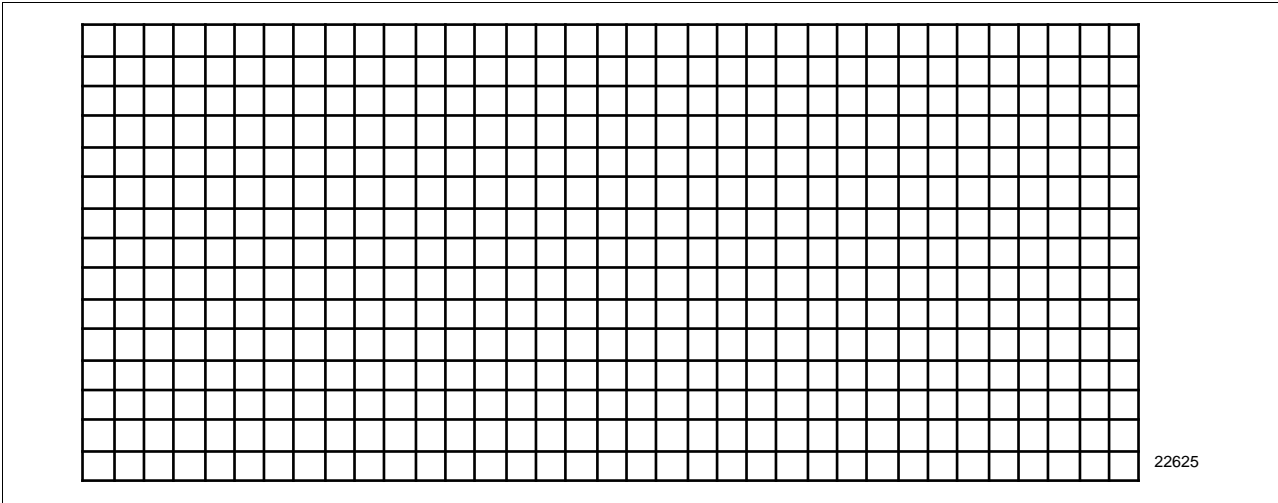


Prompt	Function	Segment	Value
STRT SEG	Start Seg.		1
END SEG	End Seg.		12
RAMP UNIT	Engr. Unit for Ramp		TIME
RECYCLES	Number of Recycles		2
SOAK DEV	Deviation Value		0
PROG END	Controller Status		LAST SP
STATE	Controller State at end		HOLD
KEYRESET	Reset SP Program		DISABL
HOT START	PV Hot Start Program Initialization or power up in SPP		DISABL
SEG1RAMP	Ramp Time	1	1 hr.
SEG2 SP	Soak SP	2	300
SEG2TIME	Soak Time	2	1 hr.:30 min.
SEG3RAMP	Ramp Time	3	1 hr.
SEG4 SP	Soak SP	4	400

Prompt	Function	Segment	Value
SEG4TIME	Soak Time	4	1 hr.
SEG5RAMP	Ramp Time	5	1 hr.:30 min.
SEG6 SP	Soak SP	6	250
SEG6TIME	Soak Time	6	3 hr.:0 min.
SEG7RAMP	Ramp Time	7	2 hr.:30 min.
SEG8 SP	Soak SP	8	500
SEG8TIME	Soak Time	8	0 hr.:30 min.
SEG9RAMP	Ramp Time	9	0
SG10 SP	Soak SP	10	400
SG10 TIME	Soak Time	10	0 hr.:30 min.
SG11RAMP	Ramp Time	11	3 hr.:30 min.
SG12 SP	Soak SP	12	200
SG12TIME	Soak Time	12	0 hr.:30 min.

Program Record Sheet Draw your ramp/soak profile on the record sheet shown in Figure 6-2 and fill in the associated information in the blocks provided. This will give you a permanent record of your program and will assist you when entering the Setpoint data.

Figure 6-2 Program Record Sheet



Prompt	Function	Segment	Value
STRT SEG	Start Seg.		
END SEG	End Seg.		
RAMPUNIT	Engr. Unit for Ramp		
RECYCLES	Number of Recycles		
SOAK DEV	Deviation Value		
PROG END	Controller Status		
STATE	Controller State at end		
KEYRESET	Reset SP Program		
HOT START	PV Hot Start Program Initialization or power up in SPP		
SEG1RAMP	Ramp Time	1	
SEG2 SP	Soak SP	2	
SEG2TIME	Soak Time	2	
SEG3RAMP	Ramp Time	3	
SEG4 SP	Soak SP	4	

Prompt	Function	Segment	Value
SEG4TIME	Soak Time	4	
SEG5RAMP	Ramp Time	5	
SEG6 SP	Soak SP	6	
SEG6TIME	Soak Time	6	
SEG7RAMP	Ramp Time	7	
SEG8 SP	Soak SP	8	
SEG8TIME	Soak Time	8	
SEG9RAMP	Ramp Time	9	
SG10 SP	Soak SP	10	
SG10 TIME	Soak Time	10	
SG11RAMP	Ramp Time	11	
SG12 SP	Soak SP	12	
SG12TIME	Soak Time	12	

6.4 Entering the Setpoint Program Data


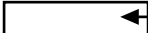



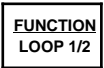




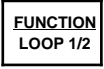

Introduction

The procedure listed in Table 6-1 tells you what keys to press and what prompts you will see when entering the setpoint program data. Follow the prompt hierarchy listed in Table 6-2 when selecting the functions for setpoint programming.

ATTENTION

Make sure SP RAMP and SP RATE are disabled first.

Table 6-1 Setpoint Program Data Entry Procedure

Step	Action	Press	Result
1	Select SP PROG Group		until you see Upper Display  ← ENABLE Lower Display  SP PROG ENABL2 ENAB12
		 or 	to enable the setpoint programming option on Loop 1, Loop 2, or both.
2	Select the functions		This accesses the function prompts SP Programming. Upper Display  ← Shows the current value for each prompt. Lower Display  ← The individual function prompts within the setpoint program group are shown. Successive presses of the [FUNCTION] key will sequentially display all the functions and their values or selections. Follow the prompt hierarchy shown in Table 6-2.
3	Change the value or selection of a function prompt	 or 	This changes the value or selection in the upper display. If the display blinks, you are trying to select an unacceptable value.
4	Enter value or selection into memory		This enters the value or selection and goes to another prompt. Repeat steps 3 and 4 for each function you want to change.
5	Exit configuration		This exits from the configuration mode.

Alarms on the setpoint program

You can configure an event to go ON or OFF at the beginning or end of any segment. Refer to *Section 3 - Configuration* under “*Alarms Parameters Group*” for details.

Prompt hierarchy

Table 6-2 lists all the function prompts for Setpoint Program data configuration in the order of their appearance. Follow the procedure in Table 6-1 to transfer the data from your setpoint Ramp/Soak profile into the controller. All parameters may be changed while the program is disabled or in HOLD.

Table 6-2 Prompt Hierarchy and Available Selections

Prompt (Lower Display)	Definition	Value or Selection (use ▲ or ▼) (Upper Display)
SP RAMP	Setpoint Ramp Selection	<i>Selections:</i> DISABL SP RAMP must be disabled to allow Setpoint Programming.
SP RATE	Setpoint Rate of Change	<i>Selections:</i> DISABL SP RATE must be disabled to allow Setpoint Programming.
SP PROG	Setpoint Ramp/Soak Programmer	<i>Selections:</i> DISABL ENABLE—Loop 1 ENABL2—Loop 2 ENAB12—Loops 1 and 2 SP PROG must be enabled to view the remaining prompts.
STRT SEG	Start Segment Number	<i>Enter Value:</i> 1 to 11
END SEG	End Segment Number	<i>Enter Value:</i> 2 to 12 Always end in a soak Segment (2,4,.....12)
RAMPUNIT	Engineering Units from Ramp Segments	<i>Selections:</i> TIME EU/MIN EU/HR
RECYCLES	Number of Program Recycles	<i>Enter Value:</i> 0 to 99 recycles
SOAK DEV	Guaranteed Soak Deviation Value	<i>Enter Value:</i> 0 to +99.00 The number selected will be 0 to 99 ± from setpoint.
PROG END	Program Termination State	<i>Selections:</i> LASTSP—Hold at last setpoint in the program F SAFE—Manual mode/Failsafe output
STATE	Program State at Program End	<i>Selections:</i> DISABL HOLD (hold mode)
KEYRESET	Reset/rerun SP Program	<i>Selections:</i> DISABL RERUN TOBEGN
HOTSTART	PV Hot Start Program Initialization or power up in SPP	<i>Selections:</i> DISABL—LSP1 is used as the initial ramp setpoint. ENABL—PV value is used as the initial ramp setpoint.
SEG1RAMP or SEG1RATE	Segment #1 Ramp Time or Segment #1 Ramp Rate	<i>Enter Value:</i> Ramp Time = 0-99hr.0-59min, or Ramp Rate = Engineering units/min or Engineering units/hr Select TIME, EU/MIN, or EU/HR at prompt "RAMP UNIT". All ramps will use the same selection.

Prompt (Lower Display)	Definition	Value or Selection (use ▲ or ▼) (Upper Display)
SEG2 SP	Segment #2 Soak Setpoint Value	<i>Enter Value:</i> Within the Setpoint limits
SEG2TIME	Segment #2 Soak Duration	<i>Enter Value:</i> 0-99hr.0-59min
SEG3RAMP or SEG3RATE	Segment #3 Ramp Time or Segment #3 Ramp Rate	<i>Enter Value:</i> Ramp Time = 0-99hr.0-59min, or Ramp Rate = EU/MIN or EU/HR
SEG4 SP	Segment #4 Soak Setpoint Value	<i>Enter Value:</i> Within the Setpoint limits
SEG4TIME	Segment #4 Soak Duration	<i>Enter Value:</i> 0-99hr.0-59min
SEG5RAMP or SEG5RATE	Segment #5 Ramp Time or Segment #5 Ramp Rate	<i>Enter Value:</i> Ramp Time = 0-99hr.0-59min, or Ramp Rate = EU/MIN or EU/HR
SEG6 SP	Segment #6 Soak Setpoint Value	<i>Enter Value:</i> Within the Setpoint limits
SEG6TIME	Segment #6 Soak Duration	<i>Enter Value:</i> 0-99hr.0-59min
SEG7RAMP or SEG7RATE	Segment #7 Ramp Time or Segment #7 Ramp Rate	<i>Enter Value:</i> Ramp Time = 0-99hr.0-59min, or Ramp Rate = EU/MIN or EU/HR
SEG8 SP	Segment #8 Soak Setpoint Value	<i>Enter Value:</i> Within the Setpoint limits
SEG8TIME	Segment #8 Soak Duration	<i>Enter Value:</i> 0-99hr.0-59min
SEG9RAMP or SEG9RATE	Segment #9 Ramp Time or Segment #9 Ramp Rate	<i>Enter Value:</i> Ramp Time = 0-99hr.0-59min, or Ramp Rate = EU/MIN or EU/HR
SG10 SP	Segment #10 Soak Setpoint Value	<i>Enter Value:</i> Within the Setpoint limits
SG10TIME	Segment #10 Soak Duration	<i>Enter Value:</i> 0-99hr.0-59min
SG11RAMP or SG11RATE	Segment #11 Ramp Time or Segment #11 Ramp Rate	<i>Enter Value:</i> Ramp Time = 0-99hr.0-59min, or Ramp Rate = EU/MIN or EU/HR
SG12 SP	Segment #12 Soak Setpoint Value	<i>Enter Value:</i> Within the Setpoint limits
SG12TIME	Segment #12 Soak Duration	<i>Enter Value:</i> 0-99hr.0-59min

6.5 Run/Monitor the Program






Introduction

Make sure all the “SP PROG” function prompts under the Set Up group “SP RAMP” have been configured with the required data.

An “H” will appear in the upper display indicating that the program is in the HOLD state.

Run/monitor functions Table 6-3 lists all the functions required to run and monitor the program.

Table 6-3 Run/Monitor Functions

Function	Press	Result
Set the Local Setpoint		You will see Upper Display  Lower Display  Local Setpoint Value
	▲ or ▼	to set the Local Setpoint value to where you want the program to start out.
Run State		Initiates the setpoint program. An “R” appears in the upper display indicating that the program is running.
Hold State		Holds the setpoint program. An “H” appears in the upper display indicating that the program is in the HOLD state. The setpoint holds at the current setpoint.
External Hold DI = “To Hold”		If Remote Switching (Digital Input option) is present on your controller, contact closure places the controller in the HOLD state, if the setpoint program is running. The “H” in the upper display will blink indicating external hold is in effect. ATTENTION The keyboard takes priority over external switch for the RUN/HOLD function. Contact reopening runs program.
Changing a Segment while in Hold	▲ or ▼	These keys will operate and allow you to change the segment number while in HOLD. If a different segment is selected, it will be started at the beginning when placed in RUN. If the original segment is brought back, the program will continue from the point placed in HOLD. NOTE: Changing a segment number may affect the alarms/events.

Function	Press	Result
Viewing the number of cycles left in the program	<div style="border: 1px solid black; padding: 2px; width: fit-content; margin: auto;">LOWER DISPLAY</div>	<p>until you see</p> <p>Upper Display <div style="border: 1px solid black; width: 60px; height: 15px; margin: 2px auto; position: relative;"> ← </div> "R" and the PV value</p> <p>Lower Display <div style="border: 1px solid black; width: 60px; height: 15px; margin: 2px auto;"></div></p> <p style="text-align: center;">RECYC <u>XX</u></p> <p style="text-align: center;"> </p> <p>Remaining Cycles 0 to 99 This number does not include the current partially completed cycle.</p>
End Program		<p>When the final segment is completed, the "R" in the upper display either changes to "H" if configured for HOLD state, or disappears if configured for disable of setpoint programming.</p> <p>The controller operates at the last setpoint in the program in automatic or will be in manual mode at the failsafe output.</p>















Power-up state

The program will be placed in HOLD mode at the beginning of the program at the local setpoint value prior to the beginning of the program.

SP programming tips

Table 6-4 gives procedures for restarting, advancing, and changing the current segment time or setpoint of a running setpoint program.

Table 6-4 Procedures for Changing a Running Setpoint Program

Function	Press	Result/Action
Restarting a running SP program		to place SP PROG into HOLD mode.
		until you see X RA XXX or X SK XX.XX in the lower display.
		until you see 1 RA XX.XX in the lower display. If the lower display already reads 1 RA XX.XX then press the [▲] key before pressing the [▼] key.
		to place SP PROG into RUN mode.
Advancing a running SP program		to place SP PROG into HOLD mode.
		until you see X RA XXX or X SK XX.XX in the lower display.
	 and  together	to select the segment number to advance to. EXAMPLE: Change 2 SK XX.XX to 3 RA XX.XX .
		to place SP PROG into RUN mode.
Changing the current segment time or setpoint in a running SP program		to place SP PROG into HOLD mode. Enter SP PROG configuration and change the segment to the new time or setpoint desired.
		until you see X RA XXX or X SK XX.XX in the lower display.
	 then 	
		to place SP PROG into RUN mode.

Section 7 – Input Calibration

7.1 Overview

Introduction

This section describes the field calibration procedures for Input 1 and Input 2. Every UDC 3300 controller contains all input actuation ranges fully factory calibrated and ready for configuration to range by the user. However, these procedures can be implemented if the factory calibration of the desired range is not within specifications.

Note that the field calibration will be lost if a change in input type configuration is implemented at a later time. The original factory calibration data remains available for later use after a field calibration is done.

What's in this section

This section contains the following topics:

	Topic	See Page
7.1	Overview	219
7.2	Minimum and maximum range values	220
7.3	Preliminary Information <ul style="list-style-type: none">• Disconnect the field wiring• Equipment needed	221 221 222
7.4	Input 1, 2, or 3 Set Up Wiring <ul style="list-style-type: none">• Thermocouple inputs using an ice bath• Thermocouple inputs using a precision resistor• RTD (Resistance Thermometer Device) inputs• Radimatic, Millivolts, or Volts except 0-10 Volts inputs• 0 to 10 Volts input• 4-20 Milliamps input	223 223 224 225 226 227 228
7.5	Input 1, 2, or 3 Calibration Procedure	229
7.6	Restoring Factory Calibration	231



WARNING—SHOCK HAZARD



INPUT CALIBRATION MAY REQUIRE ACCESS TO HAZARDOUS LIVE CIRCUITS, AND SHOULD ONLY BE PERFORMED BY QUALIFIED SERVICE PERSONNEL. MORE THAN ONE SWITCH MAY BE REQUIRED TO DE-ENERGIZE UNIT BEFORE CALIBRATION.

7.2 Minimum and Maximum Range Values

Select the range values You should calibrate the controller for the minimum (0 %) and maximum (100 %) range values of your particular sensor. If you have a two-input controller, calibrate each input separately.

Select the Voltage or Resistance equivalent for 0 % and 100 % range values from Table 7-1. Use these value when calibrating your controller.

Table 7-1 Voltage and Resistance Equivalents for 0 % and 100 % Range Values

Sensor Type	PV Input Range		Range Values	
	° F	° C	0 %	100 %
Thermocouples				
B	0 to 3300	-18 to 1816	-0.100 mV	13.769 mV
E	-454 to 1832	-270 to 1000	-9.835 mV	76.373 mV
E (low)	-200 to 1100	-129 to 593	-6.472 mV	44.455 mV
J	0 to 1600	-18 to 871	-0.886 mV	50.060 mV
J (low)	20 to 770	-7 to 410	-0.334 mV	22.400 mV
K	0 to 2400	-18 to 1816	-0.692 mV	52.952 mV
K (low)	-20 to 1000	-29 to 538	-1.114 mV	22.255 mV
NiNiMoly (NNM68)	32 to 2500	0 to 1371	0.000 mV	71.330 mV
NiNiMoly (low)	32 to 1260	0 to 682	0.000 mV	31.820 mV
NiMo-NiCo (NM90)	32 to 2500	0 to 1371	0.000 mV	71.773 mV
NiMo-NiCo (low)	32 to 1260	0 to 682	0.000 mV	31.825 mV
Nicrosil Nisil (Nic)	0 to 2372	-18 to 1300	-0.461 mV	47.513 mV
R	0 to 3100	-18 to 1704	-0.090 mV	20.281 mV
S	0 to 3100	-18 to 1704	-0.092 mV	17.998 mV
T	-300 to 700	-184 to 371	-5.341 mV	19.097 mV
T (low)	-200 to 500	-129 to 260	-4.149 mV	12.574 mV
W5W26	0 to 4200	-18 to 2315	-0.234 mV	37.075 mV
W5W26 (low)	0 to 2240	-18 to 1227	-0.234 mV	22.283 mV
Honeywell Radiamatic				
Type RH	0 to 3400	-18 to 1871	0.00 mV	57.12 mV
Type RI*	0 to 9999 max.	-18 to 9999 max.	0.00 mV	60.08 mV
RTD (IEC Alpha=0.00385)				
100 ohms	-300 to 1200	-184 to 649	25.18 ohms	329.13 ohms
100 ohms (low)	-300 to 300	-184 to 149	25.18 ohms	156.90 ohms
200 ohms	-300 to 1200	-184 to 649	50.36 ohms	658.26 ohms
500 ohms	-300 to 1200	-184 to 649	125.90 ohms	1645.65 ohms
Linear				
Milliamps	4 to 20 mA 0 to 20 mA		4.00 mA 0.00 mA	20.00 mA 20.00 mA
Millivolts	0 to 10 mV 0 to 50 mV		0.00 mV 0.00 mV	10.00 mV 50.00 mV
Volts	1 to 5 Volts 0 to 5 Volts 0 to 10 Volts		1.00 Volts 0.00 Volts 0.00 Volts	5.00 Volts 5.00 Volts 10.00 Volts
Carbon	0 to 1250 mV		0.00 mV	1250 mV
Oxygen	-30 to 510 mV		-30.00 mV	510.00 mV

*User must enter the range manually per RI type and application.

ATTENTION Thermocouple voltages are for a reference junction temperature of 32 °F (0 °C).

7.3 Preliminary Information

Calibration steps

Use the following steps when calibrating an input.

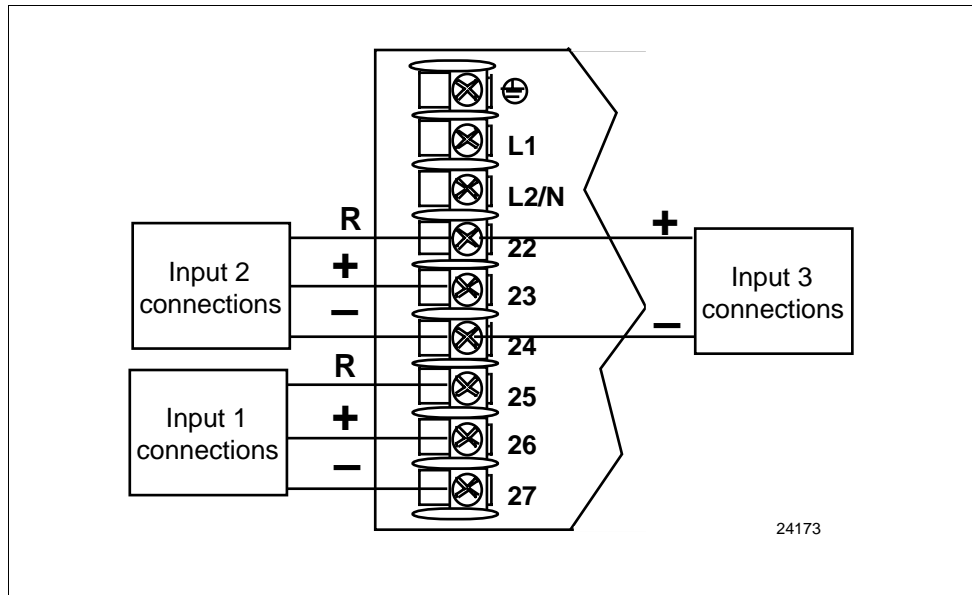
Step	Action
1	Find the minimum and maximum range values for your PV input range from Table 7-1.
2	Disconnect the field wiring and find out what equipment you will need to calibrate. DO NOT remove external resistor assemblies (if present).
3	Wire the calibrating device to your controller according to the Set Up wiring instructions for your particular input.
4	Follow the calibration procedure given for Input #1, Input #2, or Input #3, after the controller has warmed up for a minimum of 15 minutes.

Disconnect the field wiring

Depending on which input (#1, #2, or #3) you are going to calibrate, tag and disconnect any field wiring connected to the input terminals on the rear of the controller.

Figure 7-1 shows the wiring terminal designations for Input #1, Input #2, and Input #3.

Figure 7-1 Inputs #1, #2, and #3 Wiring Terminals



Equipment needed

Table 7-2 lists the equipment you will need to calibrate the specific types of inputs that are listed in the table. You will need a screwdriver to connect these devices to your controller.

Table 7-2 Equipment Needed

Type of Input	Equipment Needed
<i>Thermocouple Inputs (Ice Bath)</i>	<ul style="list-style-type: none">• A calibrating device with $\pm 0.02\%$ accuracy for use as a signal source such as a millivolt source.• Thermocouple extension wire that corresponds with the type of thermocouple that will be used with the controller input.• Two insulated copper leads for connecting the thermocouple extension wire from the ice baths to the precision calibrator.• Two containers of crushed ice.
<i>Thermocouple Inputs (Precision Resistor)</i>	<ul style="list-style-type: none">• A calibrating device with $\pm 0.02\%$ accuracy for use as a signal source such as a millivolt source.• Two insulated copper leads for connecting the calibrator to the controller.• A precision 500 ohm resistor $\pm 0.1\%$ connected across input #1 terminals 25 (R) and 27 (-) or input #2 terminals 22 (R) and 24 (-).
<i>RTD (Resistance Thermometer Device)</i>	<ul style="list-style-type: none">• A decade box, with $\pm 0.02\%$ accuracy, capable of providing stepped resistance values over a minimum range of 0 to 1400 ohms with a resolution of 0.1 ohm.• Three insulated copper leads for connecting the decade box to the controller.
<i>Milliampere, Millivolt, Volts, and Radiamatic</i>	<ul style="list-style-type: none">• A calibrating device with $\pm 0.02\%$ accuracy for use as a signal source.• Two insulated copper leads for connecting the calibrator to the controller.• Place current source at zero before switching ON.• Do not switch current sources OFF/ON while connected to the UDC 3300 input.

7.4 Input #1, #2, or #3 Set Up Wiring

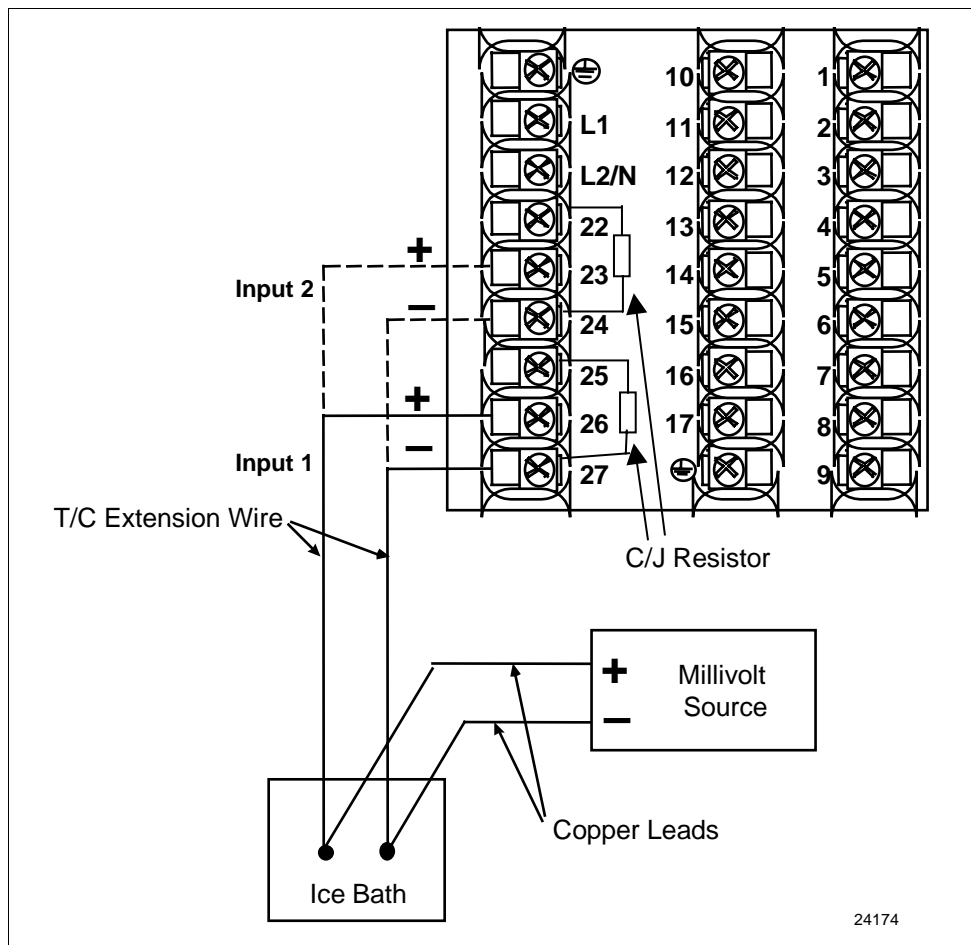
Thermocouple inputs using an ice bath

Referring to Figure 7-2, wire the controller according to the procedure given in Table 7-3.

Table 7-3 Set Up Wiring Procedure for Thermocouple Inputs Using an Ice Bath

Step	Action
1	Connect the copper leads to the calibrator.
2	Connect a length of thermocouple extension wire to the end of each copper lead and insert the junction points into the ice bath.
3	Connect the thermocouple extension wires to the terminals for Input #1 or Input #2. See Figure 7-2.
4	Connect a cold junction resistor to terminals 25 and 27 for Input #1 or terminals 22 and 24 for Input #2. See Figure 7-2.

Figure 7-2 Wiring Connections for Thermocouple Inputs Using an Ice Bath



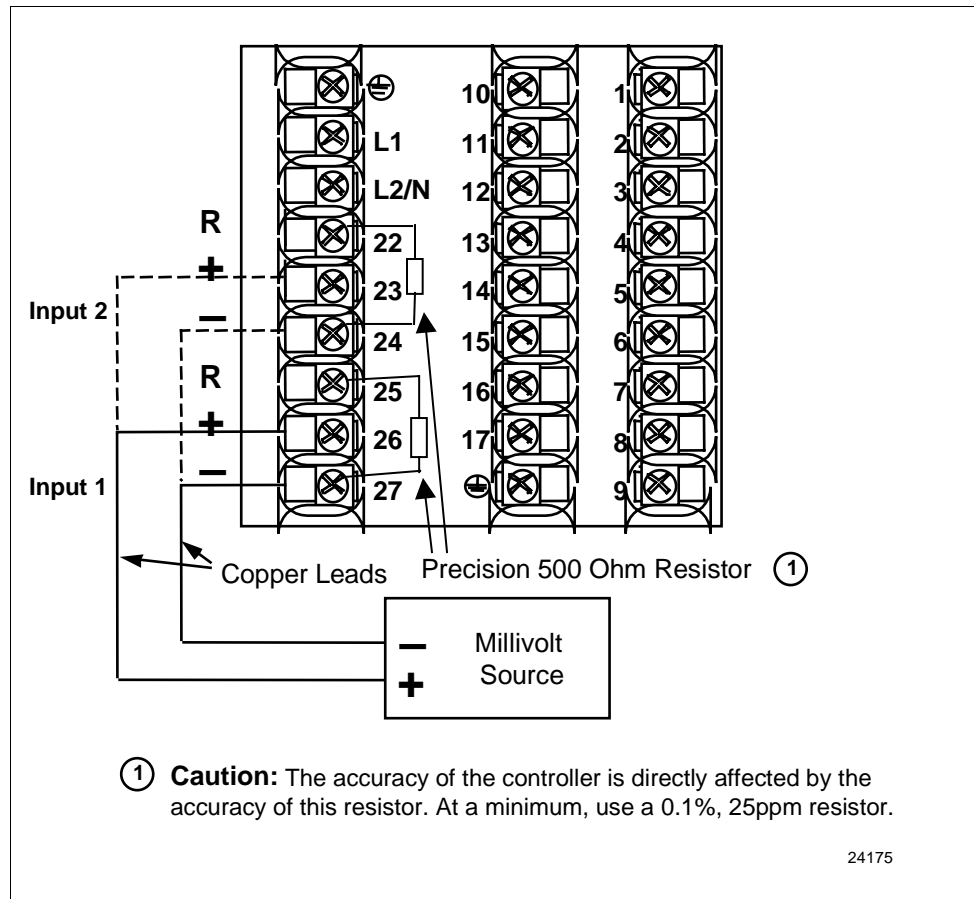
Thermocouple inputs using a precision resistor

Referring to Figure 7-3, wire the controller according to the procedure given in Table 7-4.

Table 7-4 Set Up Wiring Procedure for Thermocouple Inputs Using a Precision Resistor

Step	Action
1	Connect the copper leads to the calibrator.
2	Disconnect the cold junction resistor.
3	Install a 500-ohm precision resistor across Input 1 terminals 25 (R) and 27 (-) or Input 2 terminals 22 (R) and 24 (-). See Figure 7-3.
4	Subtract the millivolt value for 77 °F (25 °C) from the zero and span value for your range (see Table 7-1 for zero and span values) and use the adjusted value when calibrating.

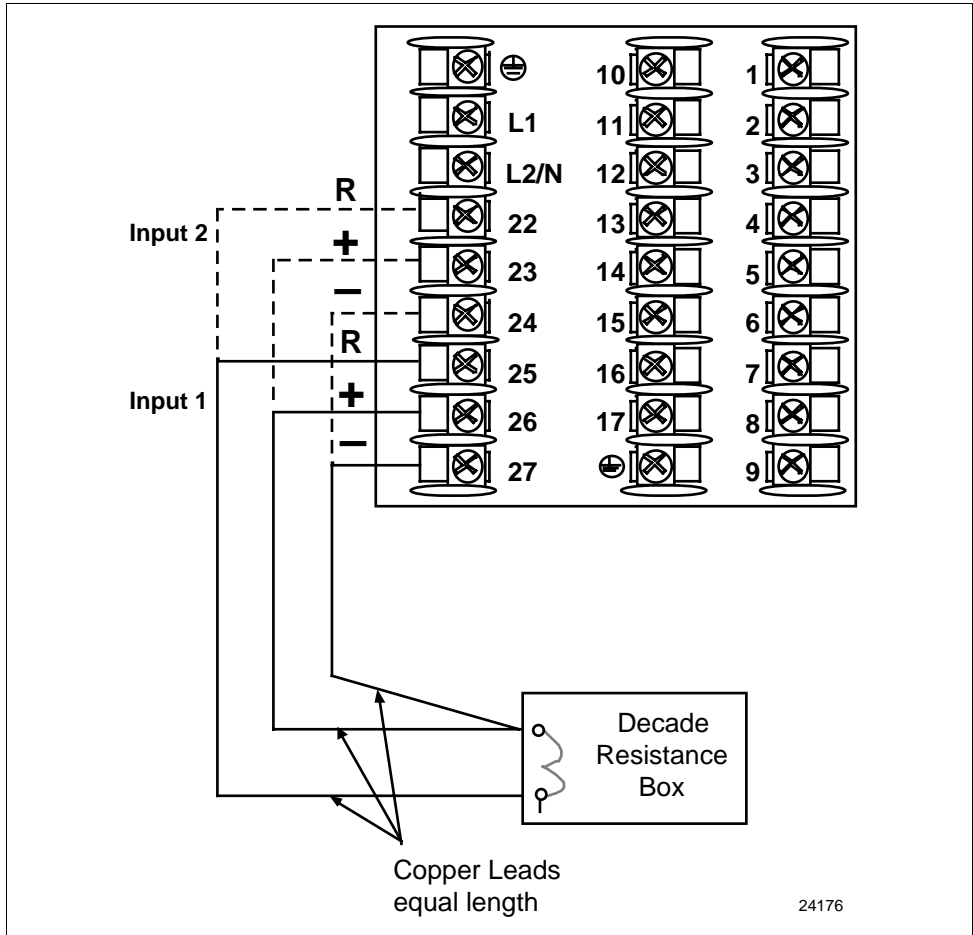
Figure 7-3 Wiring Connections for Thermocouple Inputs Using a Precision Resistor



RTD inputs

Use the copper leads and connect the calibrator to the rear terminals of Input #1 or #2. See Figure 7-4.

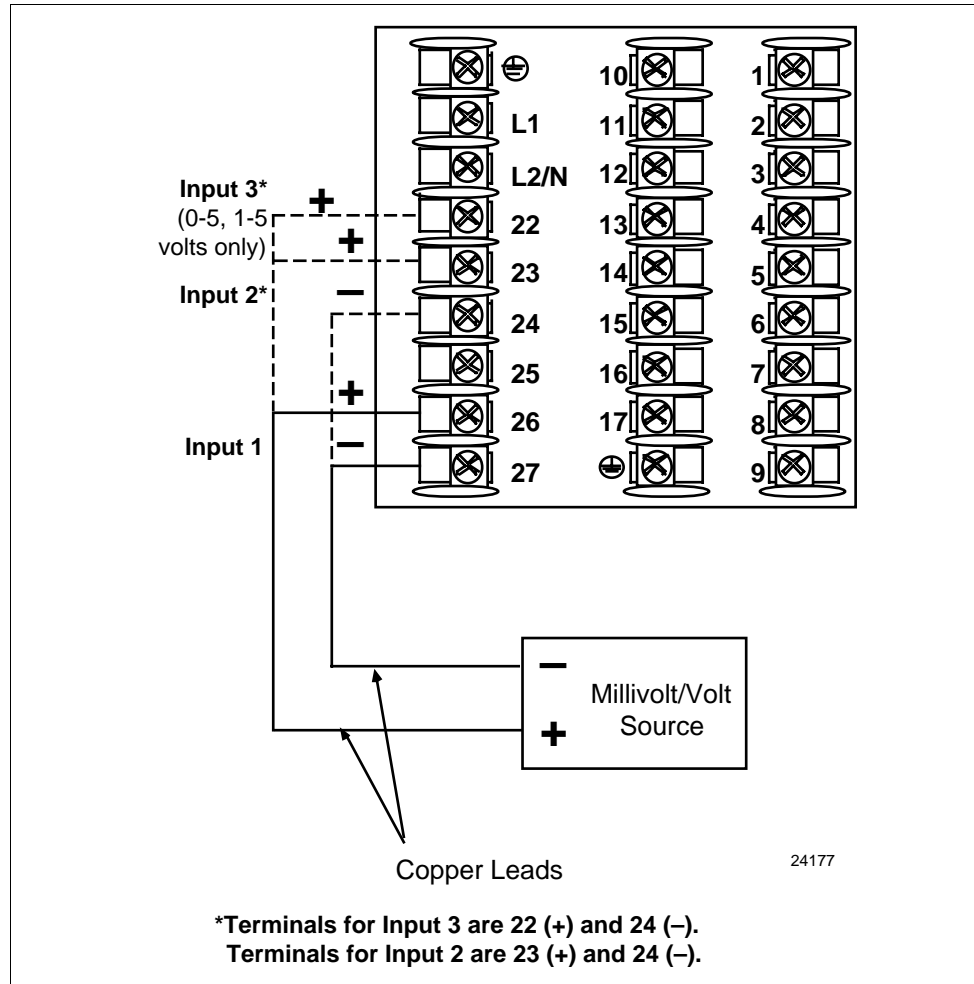
Figure 7-4 Wiring Connections for RTD



Radiamatic, millivolts, or volts (except 0 to 10 volts) inputs

Use the copper leads and connect the calibrator to the rear terminals of Input #1, #2, or #3. See Figure 7-5.

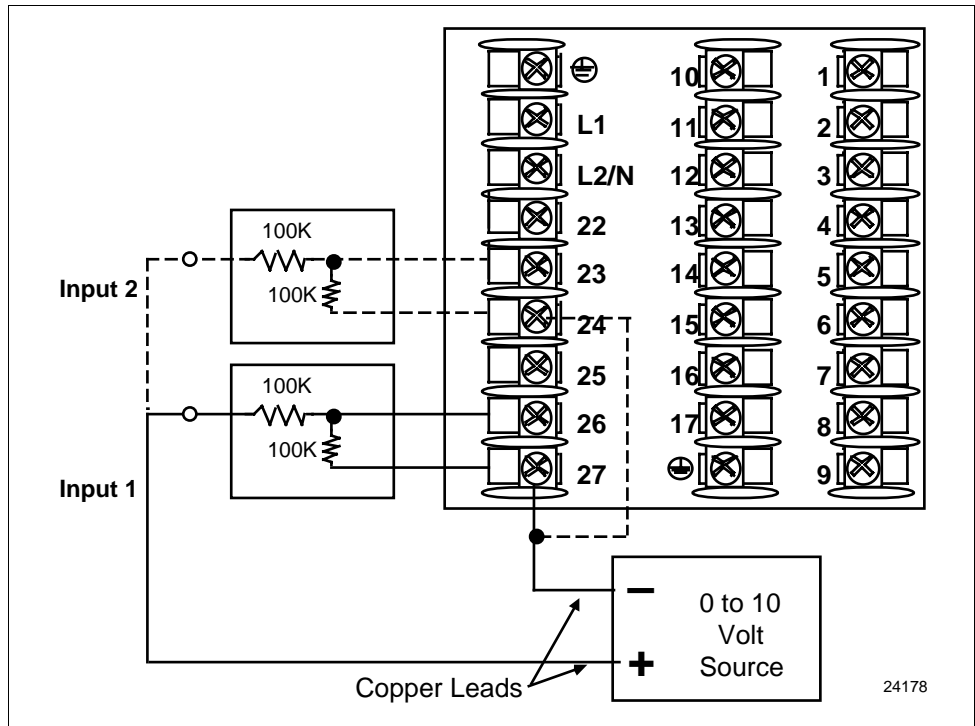
Figure 7-5 Wiring Connections for Radiamatic, Millivolts, or Volts (except 0 to 10 Volts)



0 to 10 volt inputs

Use the copper leads and connect the calibrator to the rear terminals of Input #1 or #2. See Figure 7-6.

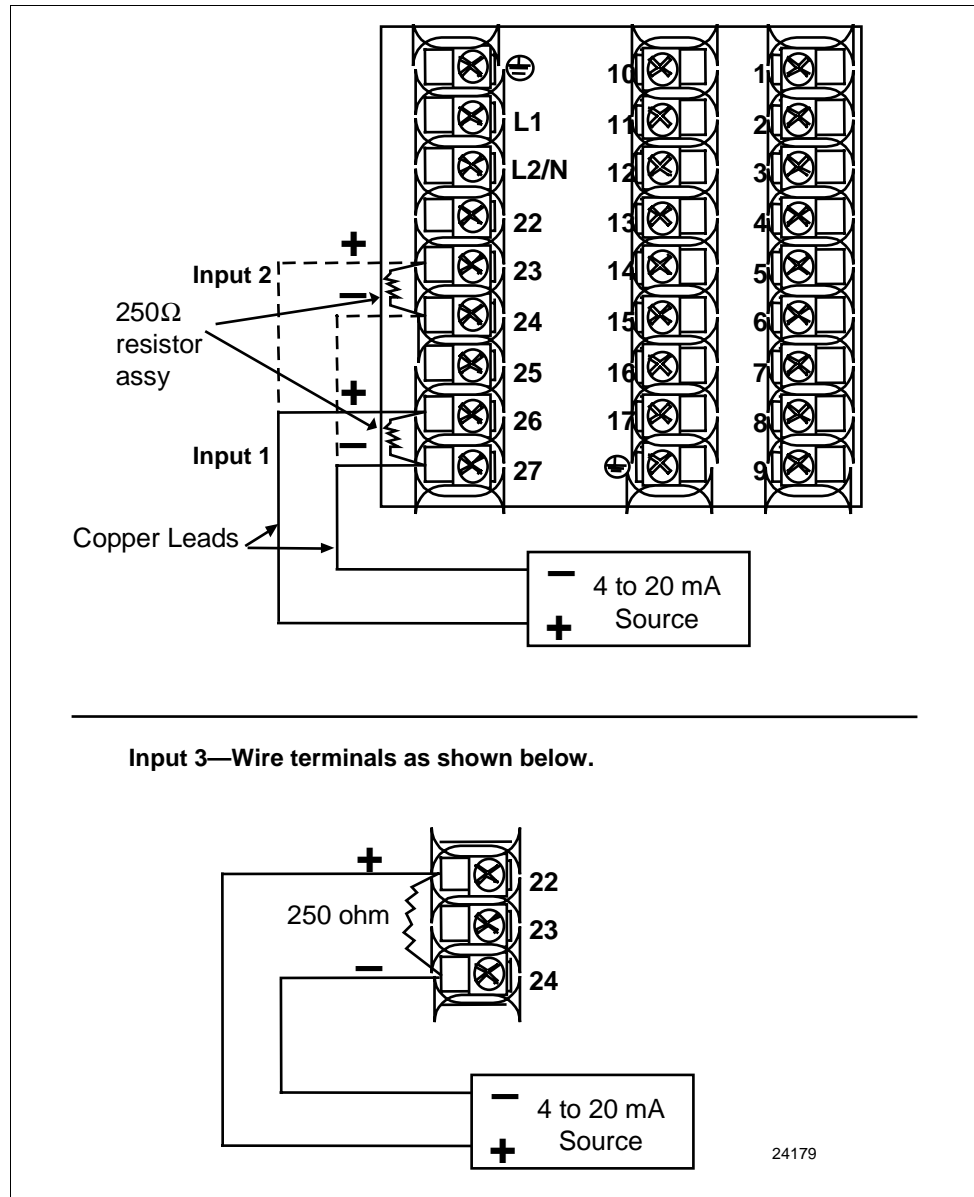
Figure 7-6 Wiring Connections for 0 to 10 Volt Inputs



4 to 20 mA inputs

Use the copper leads and connect the calibrator to the rear terminals of Input #1, #2, or #3. See Figure 7-7.

Figure 7-7 Wiring Connections for 4 to 20 mA inputs



7.5 Input #1, #2, or #3 Calibration Procedure

Introduction




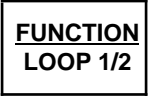




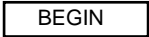
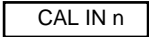
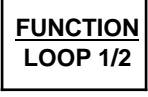

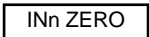
Apply power and allow the controller to warm up for 15 minutes before you calibrate. Read “*Set Up Wiring*” before beginning the procedure. Make sure you have LOCKOUT set to NONE. See *Section 3 – Configuration*.

CAUTION For linear inputs, avoid step changes in inputs. Vary smoothly from initial value to final 100 % value.

Procedure

The Calibration procedure for Input #1, #2, or #3 is listed in Table 7-5.

Table 7-5 Input #1, #2, or #3 Calibration Procedure

Step	Description	Press	Action
1	Enter Calibration Mode		until you see Upper Display  Lower Display  n = 1, 2, or 3
			You will see: Upper Display  Lower Display  n = 1, 2, or 3
		 or 	The calibration sequence is enabled and you will see: Upper Display  Lower Display  n = 1, 2, or 3 At the completion of the sequence, the selection automatically reverts to disable.
2	Calibrate 0 %		You will see: Upper Display  Lower Display  n = 1, 2, or 3 Adjust your calibration device to an output signal equal to the 0 % range value for your particular input sensor. See Table 7-1 for Voltage or Resistance equivalents. Wait 15 seconds, then go to the next step.

Step	Description	Press	Action						
3	Calibrate 100 %	<div style="border: 1px solid black; padding: 2px; display: inline-block;">FUNCTION LOOP 1/2</div>	<p>You will see: Upper Display <div style="border: 1px solid black; padding: 2px; display: inline-block;">APPLY</div></p> <p>Lower Display <div style="border: 1px solid black; padding: 2px; display: inline-block;">INn SPAN</div> n = 1, 2, or 3</p> <p>Adjust your calibration device to an output signal equal to the 100 % range value for your particular input sensor. See Table 7-1 for Voltage or Resistance equivalents.</p> <p>Wait 15 seconds, and</p> <table border="1" data-bbox="829 520 1377 730"> <thead> <tr> <th data-bbox="829 520 1192 558">If...</th> <th data-bbox="1192 520 1377 558">Then...</th> </tr> </thead> <tbody> <tr> <td data-bbox="829 558 1192 659">you are calibrating a thermocouple input (Input 1 or 2)</td> <td data-bbox="1192 558 1377 659">Go to step 4</td> </tr> <tr> <td data-bbox="829 659 1192 730">you are calibrating other than a thermocouple input</td> <td data-bbox="1192 659 1377 730">Go to step 5</td> </tr> </tbody> </table>	If...	Then...	you are calibrating a thermocouple input (Input 1 or 2)	Go to step 4	you are calibrating other than a thermocouple input	Go to step 5
If...	Then...								
you are calibrating a thermocouple input (Input 1 or 2)	Go to step 4								
you are calibrating other than a thermocouple input	Go to step 5								
4	Check the Cold Junction Temperature <div style="border: 1px solid black; padding: 2px; display: inline-block;">CAUTION</div> The accuracy of the controller is directly affected by the accuracy of this value. Change this value only if the zero and span calibration procedures did not bring the controller within the specified accuracy requirements.	<div style="border: 1px solid black; padding: 2px; display: inline-block;">FUNCTION LOOP 1/2</div>	<p>The calculations for zero and span are now stored and you will see: Upper Display <div style="border: 1px solid black; padding: 2px; display: inline-block;"> ← The cold junction temperature at the rear terminals </div> Lower Display <div style="border: 1px solid black; padding: 2px; display: inline-block;">C-J TEMP</div></p> <p>The value in the upper display is in the tenths of a degree. It is the current reading of the temperature as measured at the thermocouple terminals and recognized by the controller. You can change this value, if it is in error, using the ▲ or ▼ key.</p> <div style="border: 1px solid black; padding: 2px; display: inline-block;">ATTENTION</div> When calibrating T/C inputs using a precision 500-ohm resistor, calibrate the cold junction as 77°F (25°C).						
5	Exit the Calibration Mode	<div style="border: 1px solid black; padding: 2px; display: inline-block;">FUNCTION LOOP 1/2</div>	The controller will store the calibration constants and exit calibration mode.						

7.6 Restoring Factory Calibration














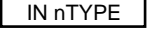


How to restore it



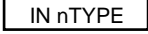


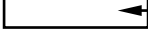
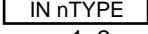

The factory calibration constants for all the input actuation types that can be used with the controller are stored in its nonvolatile memory. Thus, you can quickly restore the “Factory Calibration” for a given input actuation type by simply changing the actuation type to another type and then changing it back to the original type. See Table 7-6 for the procedure.

Procedure

Table 7-6 lists the procedure for restoring factory calibration.

Table 7-6 Restoring Factory Calibration

Step	Operation	Press	Action/Result
1	Set LOCKOUT to CALIB or NONE		until you see: Upper Display  Lower Display 
			until you see: Upper Display  ← One of the following NONE CALIB +CONF +VIEW MAX Lower Display 
		 or 	Until CALIB or NONE is in the upper display.
2	Enter INPUT 1 or 2 Setup Group		until you see: Upper Display  Lower Display  n = 1, 2, or 3
			until you see: Upper Display  ← Current Selection Lower Display  n = 1, 2, or 3
		 or 	to change the current selection to another selection.

Step	Operation	Press	Action/Result
			<p>until the lower display rolls through the rest of the functions and returns to</p> <p>Upper Display  New Selection</p> <p>Lower Display  n = 1, 2, or 3</p>
		 or 	<p>until you change the input selection in the upper display back to the proper selection. You will see:</p> <p>Upper Display  Original input selection that matches your type of sensor.</p> <p>Lower Display  n = 1, 2, or 3</p>
3	Return to normal operating mode		<p>to return to Normal operating mode.</p> <p>The factory calibration will be restored. If the problem is not corrected, contact the Honeywell Technical Assistance Center.</p> <p>1-800-423-9883 USA and Canada</p>

CAUTION

A restored factory calibration overwrites any previous field calibration done for the input and may change the High and Low Range Limits. Be sure to protect any field calibration from accidental overwrites by configuring the appropriate LOCKOUT selection after calibration. See the *Section 3 - Configuration* for specific instructions to set the lockout.

Section 8 – Output Calibration

8.1 Overview

Introduction

This section describes the field calibration procedures for the following types of outputs:

- Current Output
- Position Proportional and 3 Position Step Output
- Auxiliary Output

What's in this section

This section contains the following topics:

	Topic	See Page
8.1	Overview	233
8.2	Current Proportional Output Calibration <ul style="list-style-type: none"> • Introduction • Equipment Needed • How to Connect the Calibrator • Calibration Procedure 	234 234 234 234 235
8.3	Position Proportional and Three Position Step Output Calibration <ul style="list-style-type: none"> • Position Proportional Control • 3 Position Step Control • Equipment Needed • What connection to make • Calibration Procedure 	236 236 236 236 237
8.4	Auxiliary Output Calibration <ul style="list-style-type: none"> • Introduction • Equipment Needed • How to Connect the Calibrator • Calibration Procedure 	240 240 240 240 241



WARNING—SHOCK HAZARD



OUTPUT CALIBRATION MAY REQUIRE ACCESS TO HAZARDOUS LIVE CIRCUITS, AND SHOULD ONLY BE PERFORMED BY QUALIFIED SERVICE PERSONNEL. MORE THAN ONE SWITCH MAY BE REQUIRED TO DE-ENERGIZE UNIT BEFORE CALIBRATION.

8.2 Current Proportional Output Calibration

Introduction

Calibrate the controller so that the output provides the proper amount of current over the desired range. The controller can provide an output current range of from 0 to 21 milliamperes and can be calibrated at 4 mA for 0 % of output and 20 mA for 100 % of output or any other values between 0 mA and 21 mA.

Equipment needed

You will need a standard shop type milliammeter, with whatever accuracy is required, capable of measuring 0 to 20 milliamps.

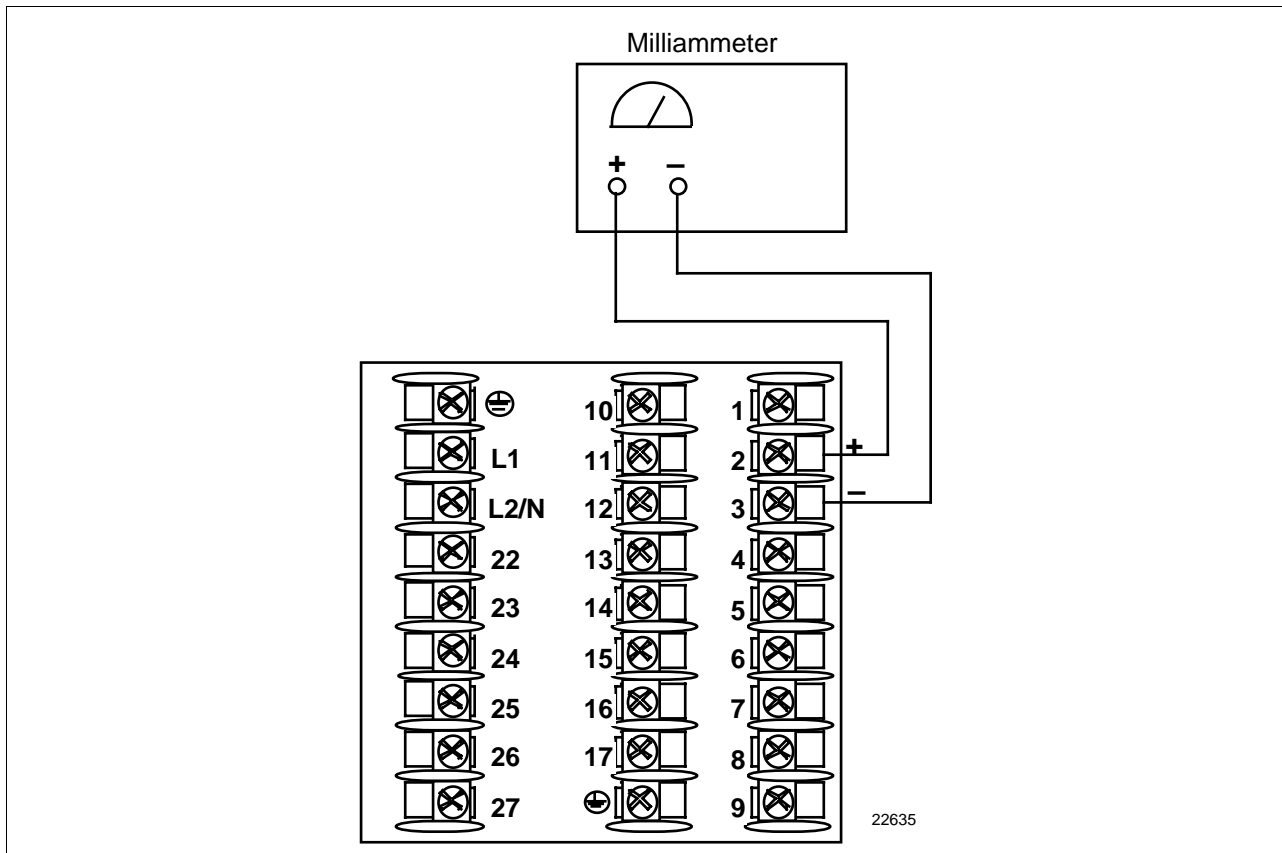
Calibrator connections

Referring to Figure 8-1, wire the controller according to the procedure given in Table 8-1.

Table 8-1 Set Up Wiring Procedure Current Proportional Output

Step	Action
1	Apply power and allow the controller to warm up 15 minutes before you calibrate.
2	Tag and disconnect the field wiring, at the rear of the controller, from terminals 2 (+) and 3 (-). See Figure 8-1.
3	Connect a milliammeter across these terminals.




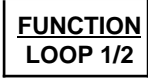




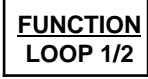




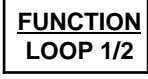


Figure 8-1 Wiring Connections for Calibrating Current Proportional Output



Procedure

The procedure for calibrating the Current Proportional Output is listed in Table 8-2. Make sure LOCKOUT in the Tuning Set Up group is set to NONE. See *Section 3 – Configuration*.

Table 8-2 Current Proportional Output Calibration Procedure

Step	Description	Press	Action
1	Enter Calibration Mode		until you see Upper Display  Lower Display 
2	Calibrate 0 %		You will see: Upper Display  a value between 1 and 2048 Lower Display 
		 or 	until the desired 0 % output is read on the milliammeter. Use the values shown below depending on the action of your valve. 0 mA For 0 to 20 mA Direct Action* 20 mA For 0 to 20 mA Reverse Action 4 mA For 4 to 20 mA Direct Action 20 mA For 4 to 20 mA Reverse Action
3	Calibrate 100 %		This stores the 0 % value and you will see: Upper Display  a value between 1 and 2048 Lower Display 
		 or 	until the desired 100 % output is read on the milliammeter. Use the values shown below depending on the action of your valve. 20 mA For 0 to 20 mA Direct Action 0 mA For 0 to 20 mA Reverse Action* 20 mA For 4 to 20 mA Direct Action 4 mA For 4 to 20 mA Reverse Action
4	Exit the Calibration Mode		The controller will store the span value.
		 or 	To exit the calibration mode.

*When attempting to achieve 0 mA, always adjust the output to about 0.5 mA, and slowly decrease until the output just goes to zero. Further decrementing will not change the output current (since the circuit cannot produce negative current) but will affect the accuracy of the output by creating a dead zone where no current flows.

8.3 Position Proportional and Three Position Step Output Calibration

Position proportional control	When the UDC 3300 controller has a Position Proportional control output, calibrate the controller so that the increase and decrease relays operate properly with respect to the position of the external feedback slidewire.
Three position step control	<p><i>Three Position Step Control Output Models with Motor Position Indication</i> (Model Numbers DC330X-EE-XXX-X2, DC330X-AA-XXX-02) This model must have its output calibrated per the entire procedure to ensure the displayed output (slidewire position) agrees with the final control element position.</p> <p><i>Three Position Step Control Output Models without Motor Position Indication</i> (Model Numbers 330X-EE-XXX-X0, DC330X-AA-XXX-X0) This model only requires that the “Motor Time” be entered as shown in the calibration procedure. FULL CALIBRATION IS NOT REQUIRED.</p>
Equipment needed	None
Connections	Apply power and allow the controller to warm up 30 minutes before you calibrate. Leave all field wiring connected to the rear terminals.
Auto mode vs manual mode	There are two ways in which to calibrate Position Proportional or 3 Position Step control: AUTO mode or MANUAL mode.
Rules for auto mode vs manual mode	The Auto-mode selection must be done at least once before the manual mode will operate properly. Failure to use the Auto-mode procedure will prevent the controller from going into automatic control mode.
Displayed values	During the Auto-mode calibration procedure, the values being displayed are used only to indicate if the motor is still traveling. To view the actual calibration value, use the manual mode after the Auto-mode is completed. These values can be changed for purposes of tweaking the calibration.

Procedure




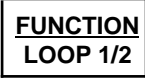




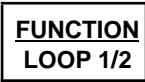


The procedure for calibrating the Position Proportional output and 3 Position Step control output is listed in Table 8-3. Make sure LOCKOUT in Tuning Set Up group is set to NONE. See *Section 3 – Configuration*.

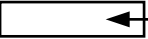





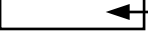

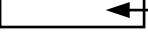



For *Three Position Step Control Output models without Motor Position Indication*, do steps 1 and 2 only.



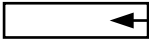

For *Position Proportional Output and Three Position Step Control Output models with Motor Position Indication*, follow the entire calibration procedure.

ATTENTION These prompts *only* appear when position OUT ALG is selected. If motor position for 3PSTEP is desired, first configure unit for “position.” After calibration the unit can be switched to 3PSTEP.

Table 8-3 Position Proportional and 3 Position Step Output Calibration Procedure

Step	Description	Press	Action
1	Enter Calibration Mode		until you see Upper Display  Lower Display 
2	Set Motor Traverse Time NOTE: This is the time it takes the motor to travel from 0 % to 100 %.		until you see: Upper Display  ← a value Lower Display 
		 or 	until the proper motor stroke time is reached (see the motor specs or measure the time) Range of setting = 5 to 1800 Seconds
3	Select Automatic or Manual Calibration		until you see: Upper Display  Lower Display  You can calibrate the controller output manually or let the controller calibrate the output automatically. If the slidewire has never been calibrated, you must use DO AUTO first. In the “Automatic Calibration Mode” (DO AUTO), the controller relays automatically move the motor in the proper direction. If desired, however, the motor may be manually positioned to 0 % and 100 % positions. Disconnect the relay wires. Use DO MAN. In the “Manual Calibration Mode” (DO MAN), the motor does not move. Instead, the existing 0 % and 100 % values may be changed with the ▲ or ▼ key.

Step	Description	Press	Action						
		▲ or ▼	<p>to select automatic or manual calibration.</p> <p>Upper Display  ← DO AUTO or DO MAN</p> <p>Lower Display  POS PROP</p> <table border="1"> <thead> <tr> <th>If you select...</th> <th>Then...</th> </tr> </thead> <tbody> <tr> <td>DO AUTO</td> <td>go to Step 4</td> </tr> <tr> <td>DO MAN</td> <td>go to Step 6</td> </tr> </tbody> </table> <p>ATTENTION When calibration is terminated, this selection reverts to DISABL.</p>	If you select...	Then...	DO AUTO	go to Step 4	DO MAN	go to Step 6
If you select...	Then...								
DO AUTO	go to Step 4								
DO MAN	go to Step 6								
4	DO AUTO Set 0 % value	FUNCTION LOOP 1/2	<p>The decrement relay is turned on to move the motor to 0 % position.</p> <p>Upper Display  ← counts of feedback slidewire (0 to 3000)</p> <p>Lower Display  ZERO VAL</p> <p>When the motor stops, the display should stop counting, then go to the next step.</p>						
5	DO AUTO Set 100 % value	FUNCTION LOOP 1/2	<p>The increment relay is turned on to move the motor to 100 % position.</p> <p>Upper Display  ← counts of feedback slidewire (0 to 3000)</p> <p>Lower Display  SPAN VAL</p> <p>When the motor stops, the display should stop counting, then, go to Step 8.</p>						
6	DO MAN Set 0 % value	FUNCTION LOOP 1/2	<p>You will see:</p> <p>Upper Display  ← The existing zero calibration value in counts.</p> <p>Lower Display  ZERO VAL</p>						
		▲ or ▼	<p>until the desired zero value is reached in the upper display.</p> <p>Upper Display  ← The desired zero value</p> <p>Lower Display  ZERO VAL</p>						
7	DO MAN Set 100 % value	FUNCTION LOOP 1/2	<p>The controller will store the 0 % value and you will see:</p> <p>Upper Display  ← The existing span calibration value in counts</p> <p>Lower Display  SPAN VAL</p>						

Step	Description	Press	Action
		 or 	<p>until the desired span value is reached in the upper display.</p> <p>Upper Display  ← The desired span value</p> <p>Lower Display </p> <p>For manual calibration, the motor does not move from its position prior to the start of Position Proportional calibration.</p>
8	Exit the Calibration Mode	<div data-bbox="656 516 799 596" style="border: 1px solid black; padding: 2px; text-align: center;"> FUNCTION LOOP 1/2 </div> <div data-bbox="656 617 799 697" style="border: 1px solid black; padding: 2px; text-align: center;"> LOWER DISPLAY </div> <p style="text-align: center;">or</p> <div data-bbox="656 730 799 810" style="border: 1px solid black; padding: 2px; text-align: center;"> SET UP </div>	<p>The controller will store the 100 % value.</p> <p>To exit the calibration mode.</p>

8.4 Auxiliary Output Calibration

Introduction

Calibrate the controller so that the Auxiliary output provides the proper amount of current over the desired range. The controller can provide an auxiliary output current range of from 0 to 21 milliamperes and can be calibrated at 4 mA for 0 % of output and 20 mA for 100 % of output or any other values between 0 mA and 21 mA.

Equipment needed

You will need a standard shop type milliammeter with whatever accuracy is required, capable of measuring 0 to 20 milliamps.

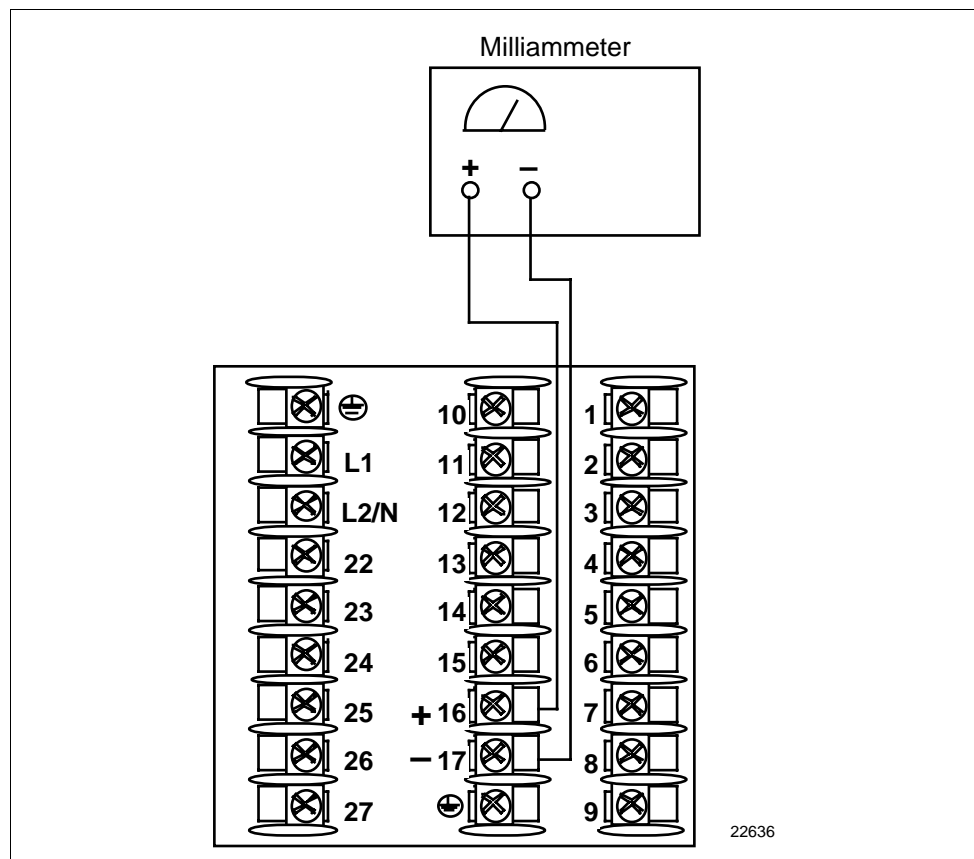
Calibrator connections

Referring to Figure 8-2, wire the controller according to the procedure given in Table 8-4.

Table 8-4 Set Up Wiring Procedure for Auxiliary Output

Step	Action
1	Apply power and allow the controller to warm up 30 minutes before you calibrate.
2	Tag and disconnect the field wiring, at the rear of the controller, from terminals 16 (+) and 17 (-). See Figure 8-2.
3	Connect a milliammeter across these terminals.



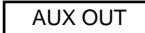
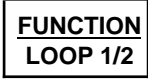




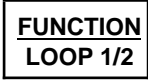

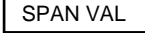


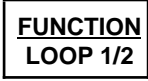


Figure 8-2 Wiring Connections for Calibrating Auxiliary Output



Procedure

The procedure for calibrating the Auxiliary Output is listed in Table 8-5. Make sure LOCKOUT in the Tuning Set Up group is set to NONE. See *Section 3 – Configuration*.

Table 8-5 Auxiliary Output Calibration Procedure

Step	Description	Press	Action
1	Enter Calibration Mode		until you see Upper Display  Lower Display 
2	Calibrate 0 %		You will see: Upper Display  ← a value between 0 and 4095 Lower Display 
		 or 	until the desired 0 % output is read on the milliammeter. Use the values shown below depending on the action of your valve. 0 mA For 0 to 20 mA Direct Action * 20 mA For 0 to 20 mA Reverse Action 4 mA For 4 to 20 mA Direct Action 20 mA For 4 to 20 mA Reverse Action
3	Calibrate 100 %		This stores the 0 % value and you will see: Upper Display  ← a value Lower Display 
		 or 	until the desired 100 % output is read on the milliammeter. Use the values shown below depending on the action of your valve. 20 mA For 0 to 20 mA Direct Action 0 mA For 0 to 20 mA Reverse Action* 20 mA For 4 to 20 mA Direct Action 4 mA For 4 to 20 mA Reverse Action
4	Exit the Calibration Mode		The controller will store the span value.
		 or 	To exit the calibration mode.

*When attempting to achieve 0 mA, always adjust the output to about 0.5 mA, and slowly decrease until the output just goes to zero. Further decrementing will not change the output current (since the circuit cannot produce negative current) but will affect the accuracy of the output by creating a dead zone where no current flows.

Section 9 – Troubleshooting / Service

9.1 Overview

Introduction

Instrument performance can be adversely affected by installation and application problems as well as hardware problems. We recommend that you investigate the problems in the following order:

- installation related problems
- application related problems
- hardware and software related problems

and use the information presented in this section to solve them. If a replacement of any part is required, follow the procedures listed under “Parts Replacement Procedures.”

What’s in this section? The following topics are covered in this section.

Topic		See Page
9.1	Overview	243
9.2	Troubleshooting Aids	245
	• Overall Error Messages	245
	• Controller Failure Symptoms	246
	• Customer Support	246
	• Determining the Software Version Number	246
9.3	Power-up Tests	247
9.4	Status Tests	248
9.5	Background Tests	250
9.6	Controller Failure Symptoms	252
9.7	Troubleshooting Procedures	253
	• Power Failure	253
	• Current Proportional Output Failure	254
	• Position Proportional Output Failure	255
	• Time Proportional Output Failure	256
	• Time/Current - Current/Time Proportional Output Failure	257
	• Alarm Relay Output Failure	258
	• Keyboard Failure	259
	• Communications Failure	260
9.8	Parts Replacement Procedures	261
	• How to remove the chassis	262
	• How to replace the display/keyboard assembly	263
	• How to remove printed wiring boards from the chassis	264
	• Printed wiring board identification	265
	• 2nd input board replacement procedure	266
	• Power input board replacement procedure	266
	• Digital input board replacement procedure	267
	• Aux. output/commun. board replacement procedure	268
	• MCU/output board replacement procedure	269
9.9	Maintenance	270

Installation related problems

Read the Installation section in this manual to make sure the UDC 3300 has been properly installed. The installation section provides information on protection against electrical noise, connecting external equipment to the controller, and shielding and routing external wiring.

ATTENTION System noise induced into the controller will result in diagnostic error messages recurring. If the diagnostic error messages can be cleared, it indicates a “soft” failure and is probably noise related. If system noise is suspected, completely isolate the controller from all field wiring. Use calibration sources to simulate PV and check all controller functions; i.e. Gain, Rate, Reset, Output, Alarms, etc.

Application related problems

Review the application of the controller; then, if necessary, direct your questions to the local sales office.

Hardware and software related problems

Use the troubleshooting error message prompts and controller failure symptoms to identify typical failures which may occur in the controller. Follow the troubleshooting procedures to correct them.

9.2 Troubleshooting Aids

Overall error messages An error message can occur

- at power-up,
- during continuous background tests while in normal operation,
- when the Status Tests are requested.

Table 9-1 lists all the error message prompts that you could see, the reason for the failure, and under what test group the prompt could appear. Refer to Tables 9-3 (Power-up), 9-5 (Status), and 9-6 (Background) for the particular test group indicated.

Table 9-1 Error Message Prompts

Error Message (lower display)	Reason for Failure	Test Group	Refer to Table
CAL MTR	Auto calibration never performed.	Power-up and Background	9-3 9-6
CAL TEST	Calibration test failure	Power-up or Status	9-3 9-5
CONF ERR	Low limit greater than high limit for PV, SP, Reset, or Output	Background	9-6
CONFTEST	Configuration test failure	Power-up or Status	9-3 9-5
E E FAIL	Unable to write to nonvolatile memory	Background	9-6
FACT CRC	Factory Calibration Cyclic Redundancy	Status	9-5
FAILSAFE or FAILSF2 (Loop 2)	Controller in Failsafe	Power-up, Background, or Status	9-3 9-5 9-6
INP1FAIL	Two consecutive failures of Input 1 integration	Background	9-6
INP2FAIL	Two consecutive failures of Input 2 integration	Background	9-6
INP3FAIL	Two consecutive failures of Input 3 integration	Background	9-6
INP1 RNG	Input 1 out of range	Background	9-6
INP2 RNG	Input 2 out of range	Background	9-6
INP3 RNG	Input 3 out of range	Background	9-6
PV LIMIT	PV out of range	Background	9-6
RAM TEST	RAM test failed	Power-up or Status	9-3 9-5
RV LIMIT	Remote Variable out of range	Background	9-6
SEG ERR	Start segment greater than ending segment	Background	9-6
SOOTING	Percent Carbon falls outside sooting boundary	Background	9-6
SW FAIL	Position Proportional slidewire input failure	Background	9-6

Controller failure symptoms

Other failures may occur that deal with the Power, Output, or Alarms. Refer to the controller failure symptom in Table 9-7 to determine what is wrong and the troubleshooting procedures to use to correct the problem.

Check Installation

If a set of symptoms still persists, refer to *Section 2 - Installation* and ensure proper installation and proper use of the controller in the system.


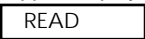

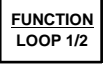
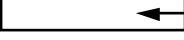

Customer support

If you cannot solve the problem using the troubleshooting procedures listed in this section, you can get **technical assistance** by contacting us. Refer to the contact information in the front of this manual. An engineer will discuss your problem with you. **Please have your complete model number, serial number, and Software version available.** The model and serial numbers can be found on the chassis nameplate. The software version can be viewed under Setup Group "Status." See Table 9-2.

Determining the software version

Table 9-2 lists the procedure for identifying the software version number.

Table 9-2 Procedure for Identifying the Software Version

Step	Operation	Press	Action
1	Select STATUS Set Up Group		until you see: Upper Display  Lower Display 
2	Read the software version		until you see: Upper Display  ← Software version Number Lower Display  Please give this number to the Customer Support person. It will indicate which version of UDC 3300 you have and help them determine a solution to your problem.

9.3 Power-up Tests

What happens at power-up

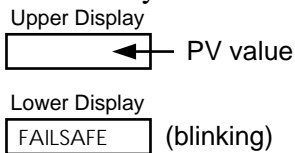
When the controller is powered-up, three tests are run by the UDC 3300 software to ensure memory integrity. As the tests are run, the displays will appear as shown in Table 9-3.

Table 9-3 Power-up Tests

Lower Display	Upper Display
RAM TEST	PASS or FAIL
CONFTEST	PASS or FAIL
CAL TEST	PASS or FAIL

Test failures

If any of these three tests fail, FAIL will appear momentarily in the upper display, then a display test is run, after which the controller will go into manual mode and you will see:



Refer to “*Status Tests*” to determine which tests have failed and how to correct them.

Position proportional or 3 position step test failures

For controller configured for Position Proportional or 3 Position Step control with motor position indication and Auto-cal has never been done, a prompt CAL MTR will appear suggesting that the controller be calibrated.

9.4 Status Tests

Introduction

When required, the results of these tests can be checked to determine the reason the controller has gone to Failsafe.

How to check the status tests

The procedure in Table 9-4 tells you how to display the results of the status tests. Table 9-5 lists the tests, the reason for the failure, and how to correct the problem.

Table 9-4 Procedure for Displaying the Status Tests Results

Step	Operation	Press	Action
1	Select STATUS Set Up Group	SET UP	until you see: Upper Display READ Lower Display STATUS
2	Read the status tests results	FUNCTION LOOP 1/2	until you see: Upper Display NO or YES YES indicates a failure Lower Display FAILSAFE Successive presses of the [FUNCTION] key will display the results of the status tests in the following order: RAM TEST CONF TEST CAL TEST FACT CRC Identify the problem and correct the failure as shown in Table 9-5.

Status Tests

Table 9-5 lists the Status tests, the reason for their failure, and how to correct the failure.

Table 9-5 Status Tests

Test (Lower Display)	Definition	Upper Display	Reason for Failure	How to Correct the Failure
FAILSAFE FAILSF2 (Loop 2)	Failsafe Fault	NO	No Failure	
		YES	Burnout configured for none and input fails. –RAM TEST failed –CONFTEST failed –CALTEST failed	1. Step through the rest of the STATUS check to identify the particular failure. Also see Table 9-6, Background tests
RAM TEST	RAM test run at power-up	PASS	No Failure	RAM test passed.
		FAIL	RAM Failure	1. Power cycle to see if the error clears.
CONF TEST	Configuration Checksum	PASS	No Failure	Configuration checksum passed.
		FAIL	Configuration data is in error.	1. Step through STATUS tests – the controller will recalculate the checksum. 2. Check all configuration prompts for accuracy. See <i>Section 3 - Configuration</i>
CAL TEST	Working Calibration	PASS	No Failure	Working calibration checksum passed.
		FAIL	The working calibration constants in the controller are in error.	1. If the controller has not been field calibrated, see <i>Section 3 - Configuration</i> and change the input to a different type. Enter it, loop through the status tests, then return the input type to the original one. 2. If the controller has been field calibrated, recalibrate the controller.
FACT CRC	Factory calibration test	PASS	No Failure	Factory calibration cyclic redundancy test passed
		FAIL	Factory set input constants have been changed due to the change in input type.	1. Cycle through Status to clear the error. 2. Check the calibration. Make sure 0 % and 100 % are correct values. 3. Recalibrate if step 1 is unsatisfactory. Refer to <i>Section 7 - Input Calibration</i> .

9.5 Background Tests

Introduction

The UDC 3300 performs on-going background tests to verify data and memory integrity. If there is a malfunction, an error message will be displayed (blinking) in the lower display.

Background tests

In the case of more than one simultaneous malfunction, only the one with the highest priority will appear in the lower display. Table 9-6 lists these background tests, the reason for their failure, and how to correct the problem.

Table 9-6 Background Tests

Lower Display	Reason for Failure	How to Correct the Problem
EE FAIL	Unable to write to non-volatile memory. Anytime you change a parameter and it is not accepted, you will see EE FAIL.	<ol style="list-style-type: none"> 1. Check the accuracy of the parameter and re-enter. 2. Try to change something in configuration. 3. Run through STATUS tests to re-write to EEPROM.
FAILSAFE or FAILSF2 (Loop 2)	This error message shows whenever the controller goes into a failsafe mode of operation. This will happen if: <ul style="list-style-type: none"> • RAM test failed • Configuration test failed • Calibration test failed • Burnout configured for none and the input failed. 	<ol style="list-style-type: none"> 1. Run through STATUS check to determine the reason for the failure. 2. Press the SET UP key until STATUS appears in the lower display. 3. Press the FUNCTION key to see what tests pass or fail, then run through the STATUS codes a second time to see if the error cleared. Correct according to the recommendations given in Table 9-5.
INP1FAIL	Two consecutive failures of input 1 integration. i.e., cannot make analog to digital conversion. This will happen if: <ul style="list-style-type: none"> • Upscale or Downscale burnout is selected • Input not configured correctly 	<ol style="list-style-type: none"> 1. Make sure the actuation is configured correctly. See <i>Section 3 - Configuration</i>. 2. Make sure the input is correct. 3. Check for gross over-ranging. 4. Replace factory calibration. See <i>Section 7.6</i>. 5. Replace the cold junction assembly.
INP2FAIL	Two consecutive failures of input 2 integration. i.e., cannot make analog to digital conversion.	Same as INP1FAIL above.
INP3FAIL	Two consecutive failures of input 3 integration, i.e., cannot make analog to digital conversion.	Same as INP1FAIL above.
SW FAIL	Position Proportional input slidewire failure	<ol style="list-style-type: none"> 1. Check motor slidewire connections. 2. Recalibrate the slidewire motor position. see the calibration section (<i>Section 8.3</i>).
CAL MTR	Position Proportional or 3 Position Step Control with Motor Position Indication, Auto Cal never performed.	1. Calibrate the controller for Position Proportional output. Refer to <i>Subsection 8.3 – Position Proportional and 3 Position Step Output Calibration</i> .
CONF ERR	<ul style="list-style-type: none"> • PV low limit is > PV high limit • SP low limit is > SP high limit • Output low limit > Output high limit 	1. Check the configuration for each item and reconfigure if necessary.

Lower Display	Reason for Failure	How to Correct the Problem
INP1 RNG	Input 1 out of range. The process input is outside the range limits.	<ol style="list-style-type: none"> 1. Make sure the range and actuation are configured properly. 2. Check the input source. 3. Restore the factory calibration. (See Section 7.6.) 4. Field calibrate. See Section 7 - Input Calibration.
INP2 RNG	Input 2 out of range. The remote input is outside the range limits.	Same as INP1 RNG above.
INP3 RNG	Input 3 out of range. The remote input is outside the range limits.	Same as INP1 RNG above.
PV LIMIT	PV out of range. $PV = INP1 + INP1 \text{ BIAS}$	<ol style="list-style-type: none"> 1. Make sure the input signal is correct. 2. Make sure the Bias setting is correct 3. Recheck the calibration. Use Bias of 0.0
RV LIMIT	The result of the formula shown below is beyond the range of the remote variable. $RV = INP2 \times \text{RATIO} + \text{BIAS}$	<ol style="list-style-type: none"> 1. Make sure the input signal is correct. 2. Make sure the Ratio and Bias settings are correct. 3. Recheck the calibration. Use a Ratio of 1.0 and a Bias of 0.0.

9.6 Controller Failure Symptoms

Introduction

In addition to the error message prompts, there are failure symptoms that can be identified by noting how the controller displays and indicators are reacting.

Symptoms

Compare your symptoms with those shown in Table 9-7 and refer to the troubleshooting procedure indicated to correct the problem.

Table 9-7 Controller Failure Symptoms

Upper Display	Lower Display	Indicators	Controller Output	Probable Cause	Troubleshooting Procedure
Blank	Blank	Off	None	Power Failure	1
OK	Displayed Output disagrees with Controller Output	OK	Controller Output disagrees with Displayed Output	Current Proportional Output	2
OK		OK		Position Proportional Output	3
OK		OK		Time Proportional Output	4
OK		OK		Current/Time Proportional Output	5
OK	OK	OK	External Alarm function does not operate properly	Malfunction in alarm output	6
Display does not function when a key is pressed				Keyboard Malfunction	7
Controller fails to go into "Slave" operation during communications				Communications Failure	8

Other symptoms


If a set of symptoms or prompts other than the one you started with appears while troubleshooting, re-evaluate the symptoms. This may lead to a different troubleshooting procedure.

If the symptom still persists, refer to the installation section in this manual to ensure proper installation and proper use of the controller in your system.

9.7 Troubleshooting Procedures


Introduction

The troubleshooting procedures are listed in numerical order as they appear in Table 9-7. Each procedure lists what to do if you have that particular failure and how to do it or where to find the data needed to accomplish the task.



WARNING—SHOCK HAZARD

TROUBLESHOOTING MAY REQUIRE ACCESS TO HAZARDOUS LIVE CIRCUITS, AND SHOULD ONLY BE PERFORMED BY QUALIFIED SERVICE PERSONNEL. MORE THAN ONE SWITCH MAY BE REQUIRED TO DE-ENERGIZE UNIT BEFORE SERVICING.



Equipment needed

You will need the following equipment in order to troubleshoot the symptoms listed in the tables that follow:

- DC Milliammeter – mAdc
- Calibration sources – T/C, mV, Volt, etc.
- Voltmeter

Procedure #1

Table 9-8 explains how to troubleshoot power failure symptoms.

Table 9-8 Troubleshooting Power Failure Symptoms

Step	What to do	How to do it
1	Check the AC line voltage.	Use a voltmeter to measure the AC voltage across terminals L1 and L2 on the rear terminal panel of the controller. Check the earth ground connection.
2	Make sure the chassis plugs into the rear of the case properly.	Withdraw the chassis and visually inspect the controller board and the inside of the case.
3	Check the system for Brown-outs, heavy load switching, etc., and conformance to installation instructions.	Refer to <i>Section 2 - Installation</i> .
4	Change PS/Input board.	Refer to Table 9-20.
5	Change MCU/Output board.	Refer to Table 9-23.

Procedure #2

Table 9-9 explains how to troubleshoot Current Proportional Output failure symptoms.

Table 9-9 Troubleshooting Current Proportional Output Failure

Step	What to do	How to do it
1	Make sure the controller is configured for Current output.	Make Algorithm Set Up group function prompt OUT ALG or OUT2 ALG = CURRNT. Refer to <i>Section 3 - Configuration</i> .
2	Check the field wiring.	Output impedance must be less than or equal to 1000 ohms.
3	Make sure all the configurable tuning constants, limits, and configuration data stored in the controller are correct. Reconfigure, if necessary.	Refer to <i>Section 3 - Configuration</i> to check all this data and how to reconfigure.
4	Check the output.	Put the controller into Manual mode and change the output from 0 % to 100 % (4-20 mA). Use a DC milliammeter at the rear terminals to verify the output.
5	Recalibrate the Current Proportional output.	Refer to <i>Section 8 - Output Calibration</i> for details.
6	Change MCU/Output board.	Refer to Table 9-23.

Procedure #3

Table 9-10 explains how to troubleshoot Position Proportional Output failure symptoms.

Table 9-10 Troubleshooting Position Proportional Output Failure

Step	What to do	How to do it
1	Make sure the controller is configured for Position Proportional output.	Make Output Algorithm Set Up group function prompt OUT ALG = POSITN. Refer to <i>Section 3 - Configuration</i> .
2	Check the field wiring.	Refer to <i>Section 2 - Installation</i> for Position Proportional Wiring information.
3	Check the output.	Put the controller into Manual mode and change the output from 0 % to 100 %.
4	Check whether the motor drives in both directions. If it does go to Step 6.	See the Position Proportional calibration procedure in Section 8 for motor slidewire calibration.
5	Check whether the motor drives in either direction. If the motor drives in one direction, check the slidewire. If the motor does not drive in either direction, check the motor.	Refer to the motor instructions.
6	Check the output voltage to the slidewire.	Should equal from 1.3 to 1.0 volts. See wiring in the installation section for terminal designations. The feedback slidewire output voltage must vary with the valve position.
7	Make sure the output relays are actuating properly.	Put the controller into Manual mode. Vary the output above and below the present value. Observe "OUT" indicator on the operator interface. If they are not working properly, check the field wiring, then go to Step 5. If they are, go to Step 8.
8	Recalibrate the controller.	Refer to <i>Section 8 - Output Calibration</i> .
9	Change MCU/Output board.	Refer to Table 9-23.

Procedure #4

Table 9-11 explains how to troubleshoot Time Proportional Output failure.

Table 9-11 Troubleshooting Time Proportional Output Failure

Step	What to do	How to do it
1	Make sure the controller is configured for Time Proportional output.	Make Output Algorithm Set Up group function prompt OUT ALG = TIME or TIME D or function prompt OUT2 ALG = TIME. Refer to <i>Section 3 - Configuration</i> .
2	Check the field wiring.	Make sure the NO or NC contact wiring is correct at the rear terminals. Refer to <i>Section 2 - Installation</i> for details.
3	Make sure all the configurable tuning constants, limits, and configuration data stored in the controller are correct. Reconfigure, if necessary.	Refer to <i>Section 3- Configuration</i> to check all this data and how to reconfigure.
4	Check the output.	Put the controller into Manual mode. Vary the output above and below the present value. Observe OUT indicator on the operator interface.
5	Change MCU/Output board.	Refer to Table 9-23.

Procedure #5

Table 9-12 explains how to troubleshoot Current/Time or Time/Current Proportional Output failure.

Table 9-12 Troubleshooting Time/Current or Current/Time Proportional Output Failure

Step	What to do	How to do it
1	Make sure the controller is configured for Time/Current or Current/Time Proportional output.	Make Output Algorithm Set Up group function prompt OUT ALG or OUT2 ALG = TI CUR or CUR TI. Refer to <i>Section 3 - Configuration</i> .
2	Check the field wiring.	Make sure the NO or NC contact wiring is correct at the rear terminals. Refer to <i>Section 2 - Installation</i> for details.
3	Make sure all the configurable tuning constants, limits, and configuration data stored in the controller are correct. Reconfigure, if necessary.	Refer to <i>Section 3 - Configuration</i> to check all this data and how to reconfigure.
4	Check the relay output.	Put the controller into Manual mode. Vary the output above and below the present value. Observe OUT indicator on the operator interface.
5	Check the Current Proportional Output.	Put the controller into Manual mode and change the output from 0 % to 100 % (4-20 mA). Use a DC milliammeter at the rear terminals to verify the output.
6	Recalibrate the controller.	Refer to <i>Section 8 - Output Calibration</i> for details.
7	Change MCU/Output board.	Refer to Table 9-23.

Procedure #6

Table 9-13 explains how to troubleshoot Alarm Relay Output failure.

Table 9-13 Troubleshooting Alarm Relay Output Failure

Step	What to do	How to do it
1	Check the alarm configuration data. If it is correct, check the field wiring.	Reconfigure if necessary. Refer to <i>Section 3 - Configuration</i> for details.
2	Check that the applicable alarm relay actuates properly depending on what you have set at prompt AxSxTYPE. If it does, check the field wiring.	If the alarm type is set for PV, place the controller in manual mode. Vary the input to raise and lower the PV around the setpoint. Listen for a click from the relay as the PV moves in either direction and note that the proper ALM1 or ALM2 is lit. EXAMPLE: If the alarm is set for MANUAL, put the controller into manual mode. The alarm light is ON. Put the controller into automatic mode and the alarm light is OFF.
3	Check the field wiring.	Make sure the NO or NC contact wiring is correct on the alarm output terminals. Refer to <i>Section 2 - Installation</i> for details.
4	Change MCU/Output board.	Refer to Table 9-23.

Procedure #7

Table 9-14 explains how to troubleshoot a Keyboard failure.

Table 9-14 Troubleshooting a Keyboard Failure

Step	What to do	How to do it
1	Make sure the keyboard is connected properly to the MCU/output and power/input boards.	Withdraw the chassis from the case and visually inspect the connection.
2	Controller Keyboard or specific keys may be LOCKED OUT via the security code.	<p>Use your four-digit security code number to change the lockout level. Refer to <i>Section 3 – Configuration</i>.</p> <p>ATTENTION Using “1000” as a security code number will override the 4-digit code previously entered.</p>
3	Run the keyboard test.	<p>Press the [SET UP] key and hold in, then press the [FUNCTION] key at the same time. The controller will run a display test. Then you will see:</p> <p>Upper Display</p> <div style="border: 1px solid black; padding: 2px; width: fit-content; margin: 0 auto;">KEYS</div> <p>Lower Display</p> <div style="border: 1px solid black; padding: 2px; width: fit-content; margin: 0 auto;">TRY ALL</div> <p>Press each key. If it works, the key name will appear in the lower display.</p>
4	Replace the display/keyboard if any keys are shorted out.	Refer to “ <i>Parts Replacement Procedures</i> ” in this section.

Procedure #8

Table 9-15 explains how to troubleshoot a Communications failure.

Table 9-15 Troubleshooting a Communications Failure

Step	What to do	How to do it
1	Check the field wiring and termination resistor.	Depending on the protocol used, refer to the proper communications manual installation section.
2	Make sure the Communications Printed Wiring Board is installed properly in the controller.	Withdraw the chassis from the case and inspect the board. See the exploded view (Figure 10-1) for location of the board. Return the chassis to the case.
3	<p>Determine if the Communications board is faulty by running a LOCAL LOOPBACK TEST.</p> <p>If the test fails, replace the board.</p>	<p>Run the Local Loopback Test.</p> <p>Press [SET UP] until you see:</p> <p>Upper Display <div style="border: 1px solid black; padding: 2px; display: inline-block;">SET UP</div></p> <p>Lower Display <div style="border: 1px solid black; padding: 2px; display: inline-block;">COM</div></p> <p>Press [FUNCTION] until you see:</p> <p>Upper Display <div style="border: 1px solid black; padding: 2px; display: inline-block;">DISABL</div></p> <p>Lower Display <div style="border: 1px solid black; padding: 2px; display: inline-block;">LOOPBACK</div></p> <p>Press ▲ or ▼, you will see:</p> <p>Upper Display <div style="border: 1px solid black; padding: 2px; display: inline-block;">ENABLE</div></p> <p>Lower Display <div style="border: 1px solid black; padding: 2px; display: inline-block;">LOOPBACK</div></p> <p>The test will run until the operator disables it here.</p>

9.8 Parts Replacement Procedures

Introduction

These procedures tell you how to access and replace the following printed wiring boards in your controller.

- Display/Keyboard
- MCU/Output
- Power/Input
- 2nd Input
- Digital Input
- Auxiliary Output
- DMCS Communications
- RS422/485 Communications
- Modbus Communications

Equipment needed

To accomplish the procedures that follow, you will need the following equipment:

- Phillips Head Screwdriver
- Flat Bladed Screwdriver
- Small Pliers

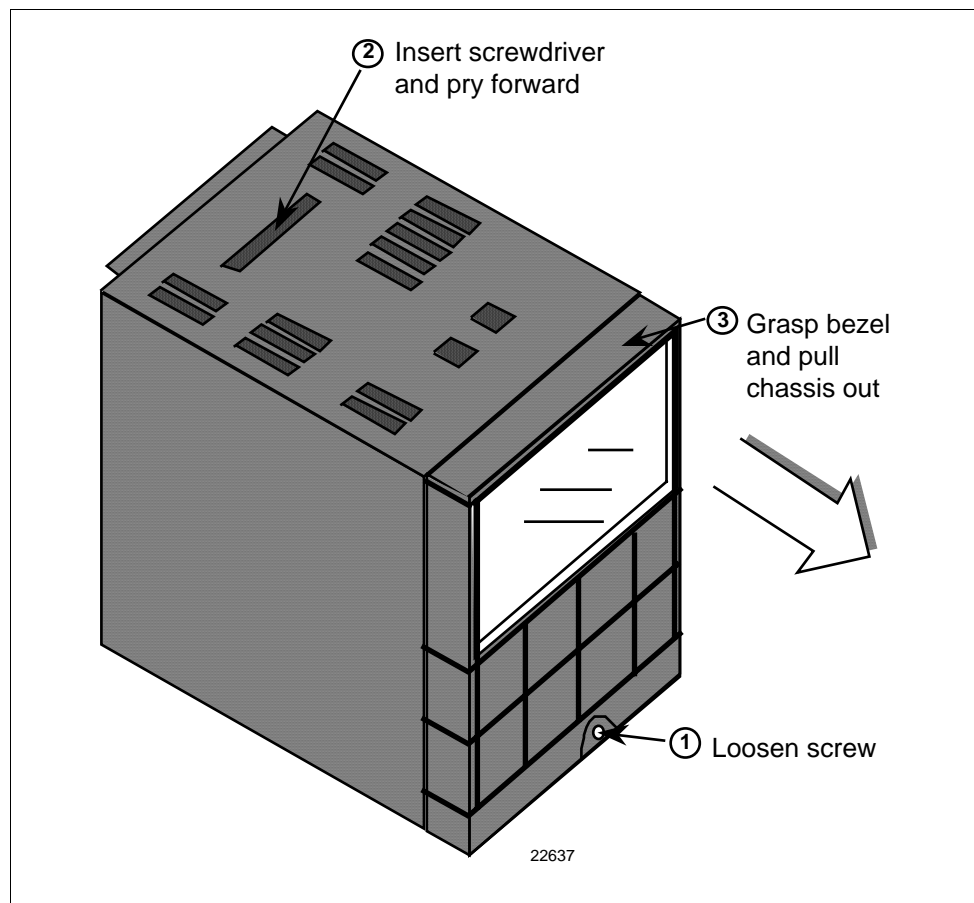
How to remove the chassis

Refer to Figure 9-1 for steps and follow the procedure listed in Table 9-16.

Table 9-16 How to Remove the Chassis

Step	Action
1	Loosen the screw on the front face.
2	Insert a flat-bladed screwdriver into the hole on the top of the case as shown in Figure 9-1 and pry chassis forward slightly until the chassis connectors separate from the back of the case.
3	Grasp the bezel and pull the chassis out of the case.

Figure 9-1 Chassis Removal



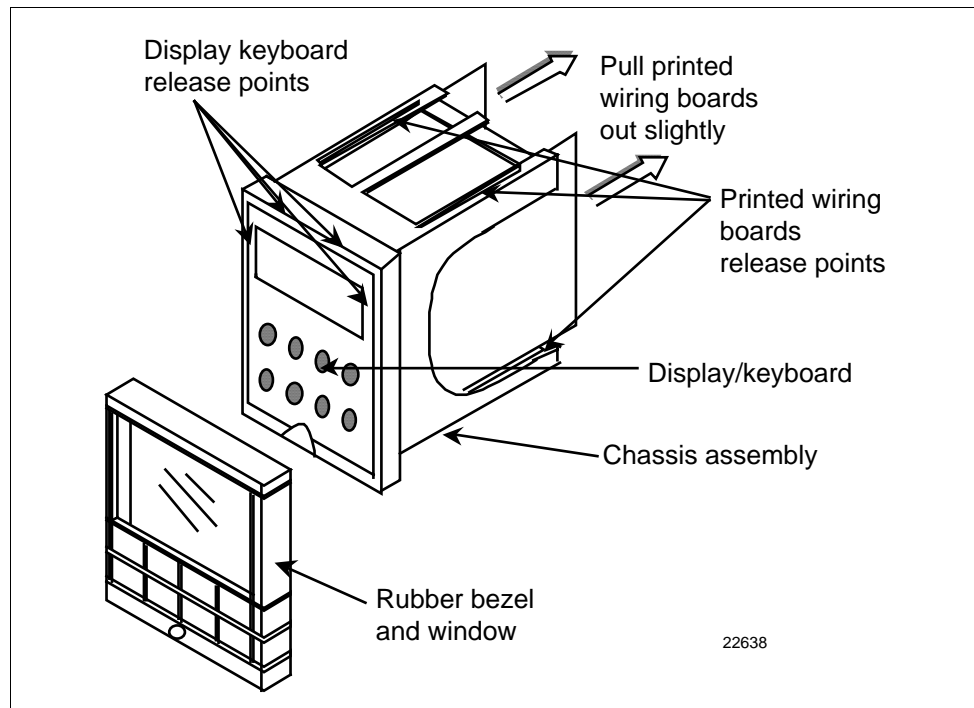
How to replace the display/keyboard assembly

Refer to Figure 9-2 and follow the procedure listed in Table 9-17.

Table 9-17 Display/Keyboard Assembly Replacement Procedure

Step	Action
1	Remove the chassis from the case as shown in Figure 9-1.
2	Peel the rubber bezel and display window off the chassis assembly.
3	Separate the chassis frame at the four release points shown in Figure 9-2 and wiggle each printed wiring board out of its socket on the display/keyboard assembly. Pull out slightly.
4	Insert a small flat-bladed screwdriver into each of the display/keyboard release points (Figure 9-2) and pry out the board.
5	Install the new board, bottom end in first, and push in the top until it clicks into place.
6	Reinstall the printed wiring boards into the rear of the display board making sure that the boards click into their release points.
7	Replace the bezel and window assembly.
8	Reinstall chassis into case. Press in hard, then tighten the screw.

Figure 9-2 Display/Keyboard Replacement



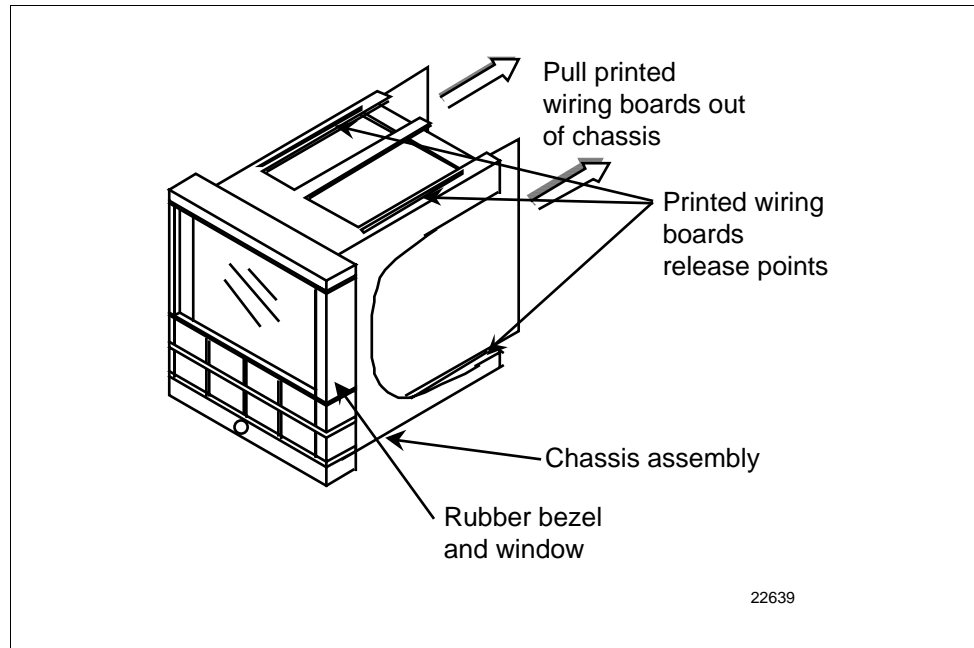
How to remove the printed wiring boards from the chassis

To remove the printed wiring boards from the chassis, refer to Figure 9-3 and follow the procedure in Table 9-18.

Table 9-18 Printed Wiring Board Removal from Chassis

Step	Action
1	Remove the chassis from the case as shown in Figure 9-1.
2	Separate the chassis frame at the release points shown in Figure 9-3 and wiggle each printed wiring board out of its socket on the display/keyboard assembly. Pull both boards out of the chassis assembly.

Figure 9-3 Removing the Printed Wiring Boards



Printed wiring board identification

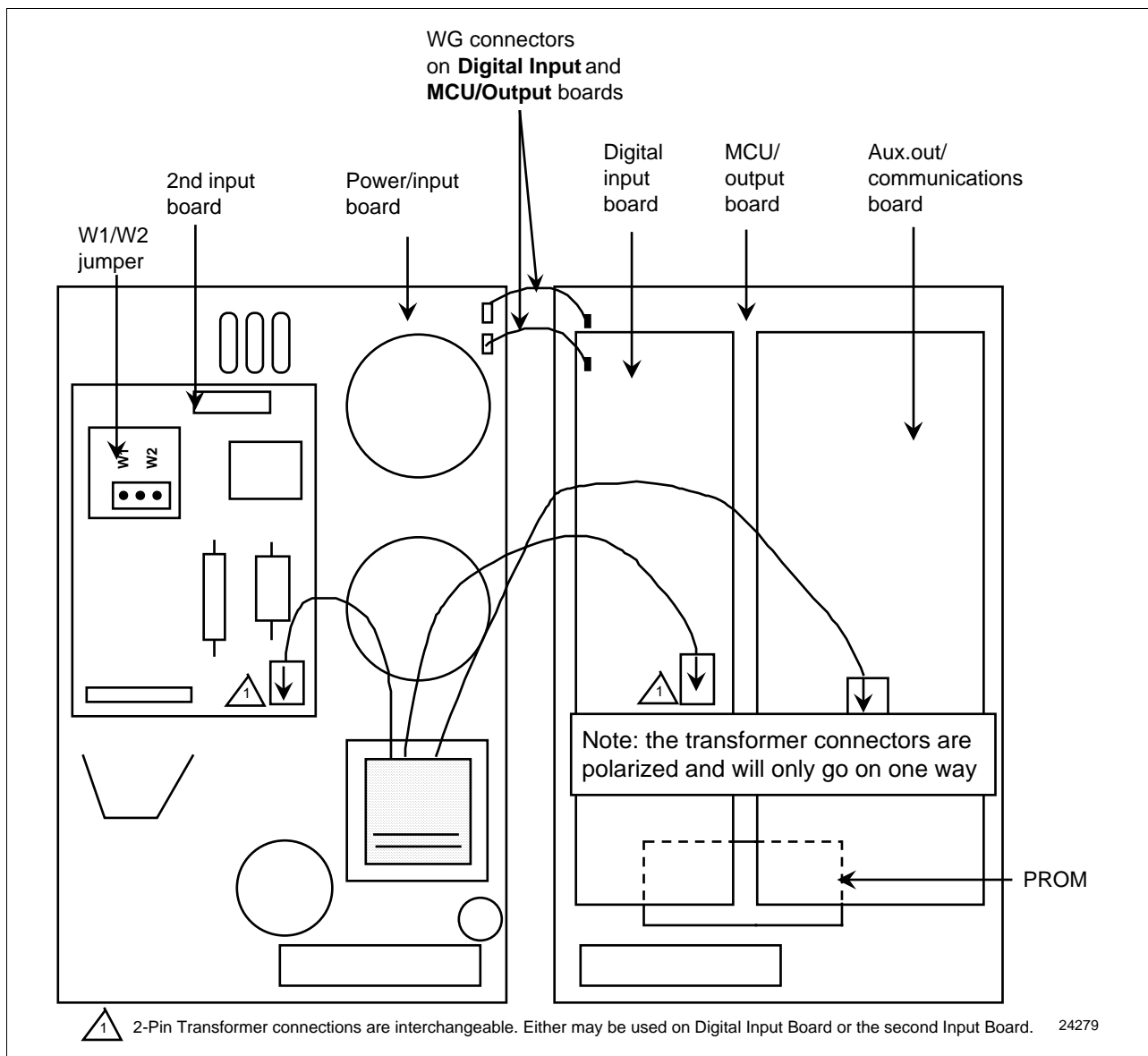
Figure 9-4 identifies each of the printed wiring boards that can be replaced. Refer to this drawing when following the replacement procedures for each of the boards, since you have to remove all of them from the chassis to replace the one you want.

In order to lay boards flat, remove the transformer lead from the Auxiliary Output/Communications board and the Digital Input board.

Refer to the specific procedure table to remove the desired board.

- 2nd Input Board—Table 9-19
- Power Input Board—Table 9-20
- Digital Input Board—Table 9-21
- Auxiliary Output/Communications Board—Table 9-22
- MCU/Output Board—Table 9-23

Figure 9-4 Printed Wiring Board Identification



2nd input board

Follow the procedure listed in Table 9-19 to replace the Second Input board—P/N 30756715-501.

Table 9-19 Second Input Board Replacement Procedure

Step	Action
1	Remove the chassis from the case. See Figure 9-1.
2	Remove the printed wiring boards from the chassis. See Figure 9-3.
3	Lay the boards flat and identify the 2nd Input board. See Figure 9-4.
4	Remove the transformer plug from connector J14.
5	The 2nd Input board is attached to the Power Input board by three mounting posts. Locate these posts under the power input board.
6	Use a small pliers and squeeze the ends of each post together and push it up through the board. Remove 2nd Input board.
7	Orient the new 2nd Input board onto the Power Input board and push the mounting posts down through the Power Input board until they click into place.
8	Replace the transformer plug onto connector J14. Make sure the Input 2 jumper (W1/W2) is in the correct position. (Refer to Table 2-4.)
9	Slide the printed wiring boards back into the chassis. Make sure the connections to the display/keyboard assembly are made and that the release points on the chassis snap into place on the printed wiring boards.
10	Reinstall the chassis into the case. Push in hard, then tighten screw.

Power input board

Follow the procedure listed in Table 9-20 to replace the Power Input board—P/N 51309404-502 (90 to 264 Vac) or 51309404-501 (24 Vac/dc).

Table 9-20 Power Input Board Replacement Procedure

Step	Action
1	Remove the chassis from the case. See Figure 9-1.
2	Remove the printed wiring boards from the chassis. See Figure 9-3.
3	Lay the boards flat and identify the Power Input board. See Figure 9-4.
4	Remove the 2nd Input board, if present. See procedure in Table 9-19.
5	Remove the transformer connections to the Digital Input board and Auxiliary Output/Communications board, if present.
6	Remove the connector from plug WG if present (current output models only). Slide a small screwdriver under the connector and lift the release.
7	Replace the Power Input board.
8	Reinstall WG connector and transformer connections to Digital Input board and Auxiliary Output/Communications board, if present.
9	Reinstall the 2nd Input board. See procedure in Table 9-19.
10	Slide the printed wiring boards back into the chassis. Make sure the connections to the display/keyboard assembly are made and that the release points on the chassis snap into place on the printed wiring boards.
11	Reinstall the chassis into the case. Push in hard, then tighten screw.

Digital input board

Follow the procedure listed in Table 9-21 to replace the Digital Input board—P/N 30756696-501.

Table 9-21 Digital Input Board Replacement Procedure

Step	Action
1	Remove the chassis from the case. See Figure 9-1.
2	Remove the printed wiring boards from the chassis. See Figure 9-3.
3	Lay the boards flat and identify the Digital Input board. See Figure 9-4.
4	Remove the transformer plug from connector J9.
5	The Digital Input board is attached to the MCU/output board by three mounting posts. Locate these posts under the MCU/output board.
6	Use small pliers and squeeze the ends of each post together and push it up through the board. Remove the Digital Input board.
7	Orient the new Digital Input board onto the MCU/Output board and push the mounting posts down through the MCU/Output board until they click into place.
8	Replace the transformer plug onto connector J9.
9	Slide the printed wiring boards back into the chassis. Make sure the connections to the display/keyboard assembly are made and that the release points on the chassis snap into place on the printed wiring boards.
10	Reinstall the chassis into the case. Push in hard, then tighten the screw.

**Aux.Out/
communications board**

Follow the procedure listed in Table 9-22 to replace the following boards:

- Auxiliary Output Board—P/N 30756687-501
- Auxiliary Output/RS422/485 Board—P/N 30756687-502
- DMCS Communications Board—P/N 30756690-502
- RS422/485 Communications Board—P/N 30756693-502 (Basic)
or P/N 30756693-503 (Expanded)

Table 9-22 Aux.Out/Communications Board Replacement Procedure

Step	Action
1	Remove the chassis from the case. See Figure 9-1.
2	Remove the printed wiring boards from the chassis. See Figure 9-3.
3	Lay the boards flat and identify the Auxiliary Output or the Communications board. See Figure 9-4.
4	Remove the transformer plug from connector J8.
5	The Aux.Out/Communications board is attached to the MCU/Output board by three mounting posts. Locate these posts under the MCU/Output board.
6	Use small pliers and squeeze the ends of each post together and push it up through the board. Remove the Aux.Out/Communications board.
7	If you are replacing a Communications Board, a new PROM is supplied with the board. Locate the PROM (shown in Figure 9-4) and gently pry out the old PROM. Orient the new PROM supplied and gently press into place.
8	Orient the new Aux.Out/Communications board onto the MCU/Output board and push the mounting posts down through the MCU/Output board until they click into place.
9	Replace the transformer plug onto connector J8.
10	Slide the printed wiring boards back into the chassis. Make sure the connections to the keyboard assembly are made and that the release points on the chassis snap into place on the printed wiring boards.
11	Reinstall the chassis into the case. Push in hard, then tighten the screw.

MCU/output board

Follow the procedure listed in Table 9-23 to replace the following MCU/output boards:

Basic

- Current Output—P/N 51309401-504
- Relay Output—P/N 51309401-505

Expanded

- Current Output—P/N 51309401-504
- Relay Output—P/N 51309401-505

Table 9-23 MCU/Output Board Replacement Procedure

Step	Action
1	Remove the chassis from the case. See Figure 9-1.
2	Remove the printed wiring boards from the chassis. See Figure 9-3.
3	Lay the boards flat and identify the MCU/Output board. See Figure 9-4.
4	Each option board is held onto the MCU/Output board with three posts. Locate these posts under the MCU/Output board.
5	Use small pliers and squeeze the ends of each post together and push it up through the board. Remove the option boards present.
6	Remove the transformer connections to the Digital Input board and the Auxiliary Output/Communications board, if present.
7	Remove the Digital Input Board, if present. See Table 9-21.
8	Remove the Auxiliary Output/Communications board, if present. See Table 9-22.
9	Remove the connector from plug WG. Slide a small screwdriver under the connector and lift the release.
10	Replace the MCU/Output board.
11	Reinstall the Digital Input board, if present, onto the new MCU/Output board.
12	Reinstall the Auxiliary Output/Communications board, if present, onto the new MCU/Output board.
13	Reinstall the WG connector and the transformer connectors to the Digital Input board and Auxiliary Output/Communications board, if present.
14	Slide the printed wiring boards back into the chassis. Make sure the connections to the display/keyboard assembly are made and that the release points on the chassis snap into place on the printed wiring boards.
15	Reinstall the chassis into the case. Push in hard, then tighten the screw.

9.9 Maintenance

Cleaning

If you find it necessary to clean the elastomer bezel, use mild soapy water.

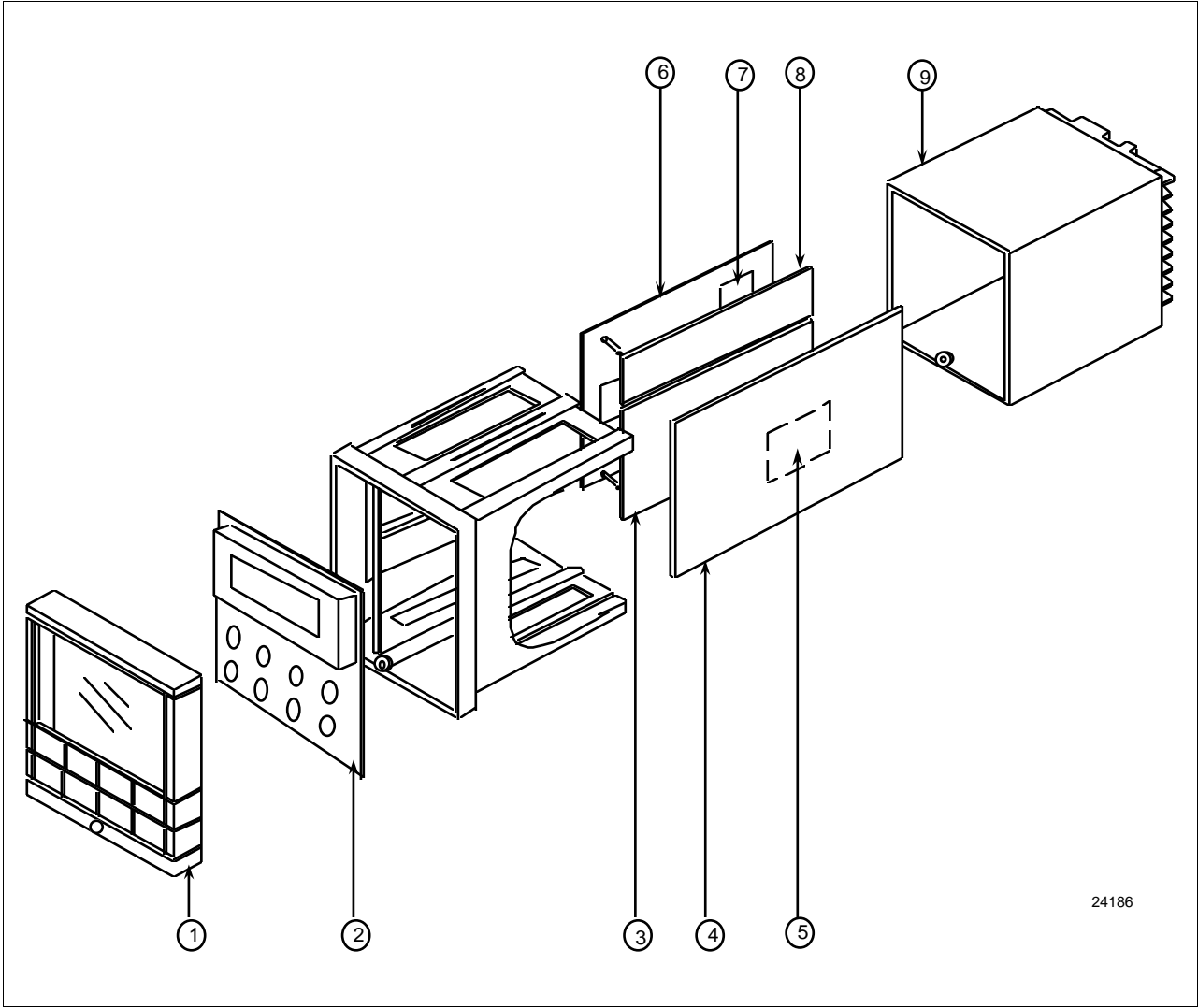
Section 10 – Parts List

10.1 Exploded View

Introduction

Figure 10-1 is an exploded view of the UDC 3300 Controller. Each part is labeled with a key number. The part numbers are listed by key number in Table 10-1. There is a list of parts not shown in Table 10-2.

Figure 10-1 UDC 3300 Exploded View



Parts identification

Table 10-1 lists the part numbers for the key numbers shown in the exploded view.

Table 10-1 Parts Identification

Key Number	Part Number	Description	Quantity
1	30756667-526	Bezel Assembly—Gray	1
2	30756672-501	Display/Keyboard Printed Wiring Assembly	1
3	30756687-501 30756687-502 30756690-502 39656693-502 30756693-503	Auxiliary Output Printed Wiring Board Auxiliary Output/Half Duplex RS422/485 Communications Board DMCS Communications Printed Wiring Board RS422/485 Communications Printed Wiring Board—includes Basic Prom RS422/485 Communications Printed Wiring Board (Full or Half Duplex)—includes Expanded Prom	1
4	51309404-502 51309404-501	Power/Input Printed Wiring Board 90-264 Vac Power/Input Printed Wiring Board 24 Vac/dc	1
5	30756715-501	2nd Input Printed Wiring Board	1
6	51309401-504 51309401-505	Current Output/MCU Printed Wiring Board Relay Output/MCU Printed Wiring Board	1
7	30755306-501 30756725-501 30756679-501	Relay, Electromechanical Relay, Solid State 1 Amp Open Collector Output	1 per kit
8	30756696-501	Digital Input Printed Wiring Board	1
9	30756721-501	Case Assembly	1
	51309713-501 51309714-501 51309715-501 51309716-501 51309717-501	FIELD UPGRADE SOFTWARE KITS: Upgrade DC330B to SPP + Carbon Upgrade DC330E to SPP + Math + HealthWatch Upgrade DC330E to SPP + 2 Loops + HealthWatch Upgrade DC330E to SPP + Math + 2 Loops + HealthWatch Upgrade DC330D to SPP	

Parts not shown

Table 10-2 lists the part numbers of the parts not shown in the exploded view.

Table 10-2 Parts Not Shown

Part Number	Description	Quantity
30731996-506	4-20 mA Resistor Assembly, 250 ohms	1
30754465-501	0-10 Volt Input Resistor Assembly, 100K Pair	1
30732481-501 30732481-502	Varistor, 120 V Varistor, 240 V	1
30755050-501	Mounting Kit	1
30756764-002	Rear Cover Kit	1
30755223-002 30755223-003	DIN Adapter Kit, Blue DIN Adapter Kit, Gray	1
30757088-501	Cold Junction Resistor Kit	1
30756018-003	External Relay, Solid State 10 Amp	1
30756683-001	NEMA3 Gasket (Panel to case)	
30757215-001	NEMA4 Front Face Kit	1

Section 11 – Appendix A – Manual Tuning

11.1 Overview

Introduction

When you tune a controller, there are some things to consider:

- Process Characteristics - Gain, Time Constants, etc.
- Desired response - Minimal overshoot

Basically, controller tuning consists of determining the appropriate values for the Gain (PB), Rate (Derivative), and Reset (Integral) time tuning parameters (control constants) that will give the control you want.

Depending on the characteristics of the deviation of the process variable from the setpoint, the tuning parameters interact to alter the controller's output and produce changes in the value of the process variable.

Since each parameter responds to a specific characteristic of the deviation, you may not need a combination of all three. It depends on the process characteristics and the desired control response.

Tuning technique

You can estimate a starting point and the tuning parameters required to give the desired controller response and with some experience become proficient with this method.

An alternate approach is to rely on a tuning technique. In practice, tuning techniques usually do not give exactly the type of response desired; thus, some final adjustments to the tuning parameters must be made.

However, you should at least obtain a reasonable starting point from which the desired response characteristics can be obtained.

Controller tuning procedures

There are three procedures for tuning the controller:

- Time, Position, or Current Proportional simplex control,
- Duplex Time or Current Proportional control,
- Two sets of tuning constants for single output operation.

The suggested procedures describe how to establish and store values of Gain (PB), Rate, and Reset time constants for your process. You must know the type of control and algorithm your controller has.

Tuning aids

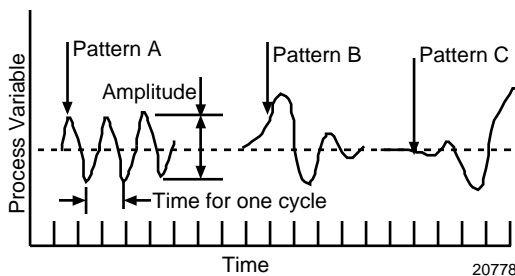
A graphic recorder (such as Honeywell model DPR, DR4500, or VP131) connected to the process variable will make it easier to determine when the oscillations are constant and also the time for one oscillation. If a recorder is not available, you can use a stopwatch to time the oscillation of the process variable displayed on the controller.

11.2 Time, Position, or Current Proportional Simplex Control

Procedure

The procedure listed in Table 11-1 gives you the steps for manually tuning a controller with Time, Position, or Current proportional simplex control.

Table 11-1 Manual Tuning Procedure for Simplex Control

Step	Action
1	In Manual Mode, adjust the output to bring the PV (Process Variable) near the desired value.
2	Set the Rate time to 0 minutes and set the Reset time to the maximum value (50.00 minutes) or set repeats/min to the minimum value to minimize reset action If applicable, set the CYCLE TIME to 4 seconds and DEADBAND to 0.5.
3	Increase GAIN (decrease PB) significantly. Try a factor of 10.
4	Adjust the local setpoint to equal PV and switch to Automatic control mode.
5	Increase the setpoint by 5 or 10% and observe the process variable response.
6	If the PV oscillates, continue to Step 7. If it does not oscillate, return to the original setpoint and increase GAIN (decrease PB) again by a factor of 2, and repeat Step 5.
7	<p>Compare the oscillations with the figure below:</p>  <p>The graph shows three oscillation patterns labeled Pattern A, Pattern B, and Pattern C. The vertical axis is labeled 'Process Variable' and the horizontal axis is labeled 'Time'. A dashed horizontal line represents the setpoint. Pattern A is a regular sine wave. Pattern B is a wave with increasing amplitude. Pattern C is a wave with decreasing amplitude. A vertical double-headed arrow indicates 'Amplitude' and a horizontal double-headed arrow indicates 'Time for one cycle'.</p> <ul style="list-style-type: none"> • If the oscillation matches pattern A, go to Step 8. • If the oscillation matches pattern B, increase GAIN (decrease PB) by a factor of 2 and repeat Steps 4 to 6. • If the oscillation matches pattern C, decrease GAIN (increase PB) by a factor of 0.8 and repeat Steps 4 to 6 <p>The amplitude of the cycle is immaterial, but all of the elements of the loop must be within the operating range (i.e., the valve must not go full open or closed).</p>
8	Record the current value of GAIN (or PB) and measure and record the value of time for one completed oscillation of PV.
9	Select the proper set of formulas from Table 11-2. Use the values of Gain (or PB) and time (in minutes) in the formulas to arrive at the controller's tuning parameters settings.

Step	Action
10	<p>Enter the values of GAIN (or PB), RATE, and RESET in minutes (or repeats per minute) into the UDC 3300 controller and verify that the PV response is adequate.</p> <p>Make additional trimming adjustments, if necessary, to fine tune the controller per the guidelines shown below:</p> <p>TO REDUCE OVERSHOOT Less Gain (more PB) perhaps a longer Rate time.</p> <p>TO INCREASE OVERSHOOT OR INCREASE SPEED OR RESPONSE More Gain (less PB), perhaps shorter Rate time.</p>

Manual tuning formulas Table 11-2 lists the formulas used in the procedure listed in Table 11-1.

Table 11-2 Manual Tuning Formulas

	Units	
	GAIN and RESET TIME in $\frac{\text{Minutes}}{\text{Repeat}}$	% PROPORTIONAL BAND and RESET ACTION in $\frac{\text{Repeats}}{\text{Minutes}}$
Proportional (P) only Use PD+MR Algorithm (i.e. No Reset)	GAIN = Measured Gain x 0.5 RESET TIME = 50.00 (minimum reset) RATE = 0	%PB = Measured PB x 2 RESET ACTION = 0.02 (repeats/minute) RATE = 0
Proportional + Reset (PI) (No Rate)	GAIN = Measured Gain x 0.5 RESET TIME = $\frac{\text{Measured Time}}{1.2}$ (M/R) RATE = 0	%PB = Measured PB x 2.2 RESET ACTION = $\frac{1.2}{\text{Measured Time}}$ (R/M) RATE = 0
Proportional + Reset + Rate (PID)	GAIN = Measured Gain x 0.6 RESET TIME = $\frac{\text{Measured Time}}{2}$ RATE = $\frac{\text{Measured Time}}{8}$	%PB = Measured PB x 1.7 RESET ACTION = $\frac{2}{\text{Measured Time}}$ RATE = $\frac{\text{Measured Time}}{8}$

11.3 Time Proportional Duplex or Current Proportional Duplex Control

Introduction For HEAT/COOL applications.
Tune the controller with the output above 50% for Heat and below 50% for Cool.

HEAT/COOL prompts The “TUNING” function prompts for HEAT/COOL are:

<u>HEAT</u>	<u>COOL</u>
PB or GAIN	GAIN2
RSETMIN or RSETRPM	RSET2MIN or RSETRPM2
RATEMIN	RATE2MIN
CYCSEC	CYC2SEC

11.4 Two Sets of Tuning Parameters for Single Output Operation

Introduction You can use two sets of tuning constants for single output types and tune each set separately.

TWO SETS prompts The “TUNING” function prompts for two sets are:

<u>PID SET 1</u>	<u>PID SET 2</u>
PB or GAIN	GAIN2
RSETMIN or RSETRPM	RSET2MIN or RSETRPM2
RATEMIN	RATE2MIN
CYCSEC	CYC2SEC

Index

- %**
% Oxygen control, 203
- A**
Aborting PV adaptive tuning, 200
Accutune, 181
Accutune, 194
Accutune error prompts, 201
Accutune Set Up group, 47
Accutune Set Up Group, 88
Adaptive tune, 89
Adaptive tune error status, 91
Advancing a running SP program, 217
Alarm blocking, 142
Alarm on totalizer value, 185
Alarm setpoints, 171
Algorithm Data Set Up Group, 92
Auto bias, 120, 126
Auto Manual Station mode
 backup control feature, 190
Auto/Manual Station mode, 190
Automatic mode, 158
Automatic switchover value, 125
Auxiliary output calibration, 240
Auxiliary output, 129
Auxiliary Output board, 268
Auxiliary output connections, 29
Auxiliary Output/RS422/485 board, 268
- B**
Baud rate, 136
Bias, 114
Burnout protection, 114
- C**
Calibration mode, 229
Calibration steps, 221
Carbon control, 203
Carbon potential, 99, 202
Carbon potential selections, 97
CE Conformity, 1
Changing current segment time or setpoint in running SP program, 217
Characterizer, 104, 105
Cleaning, 270
CO compensation, 203
Cold junction temperature, 230
Communication units, 137
Communications option connections, 30
Communications selection, 135
Communications Set Up Group, 135
Composite wiring diagram, 18
Configuration Prompt Definitions, 79
Control 2 algorithm, 94
Control algorithm, 92
Controller dropoff value, 122, 127
Controller failure symptoms, 246
Current duplex, 110
Current output 2, 129
Current output/ universal output connections, 26
Current proportional duplex, 276
Current simplex, 109
Current/time duplex, 110
Cycle time (cool), 81
Cycle time (heat), 81
- D**
Deadband, 122, 127
Demand Tuning, 47
Dewpoint, 98
Dewpoint control, 203
Diagnostic error messages, 154
Digital input combinations, 134
Digital Input option, 186
Digital input selections, 131
Digital inputs (remote mode switching), 181
Digital inputs 1 and 2 combination operation, 188
Digital inputs 1 and 2 combination selections, 188
Digital inputs connections, 29
Digital output status, 111
Dimensions, 13
Direct acting control, 121, 126
Disconnect the field wiring, 221
Display Parameters Set Up Group, 143
Displays and indicators, 3
DMCS Communications board, 268
Duplex, 136
Duplex Heat/Cool applications, 84
- E**
Eight segment characterizer, 105, 106
Eight segment characterizer, 104
Eight-segment characterization, 184
Electrical considerations, 15
Electrical noise, 15
Electromechanical Relay Output., 22
Emissivity, 115
End segment number, 206
Exploded view, 271
External program reset, 215
External setpoint program reset, 132
- F**
Failsafe mode, 122, 127
Failsafe output value, 122, 128
Feedforward multiplier, 97
Feedforward summer, 96
Filter, 114
Flow totalizer, 184
Function Prompts, 36
Fuzzy overshoot suppression, 193
Fuzzy Overshoot Suppression, 47

Index

G

Gain, 80
Gain 2, 81
Gain scheduling, 119
Gain Value for Gain Scheduling, 83
grounding, 15
Guaranteed soak, 207

H

HealthWatch
 counters, 144
 timers, 144
High output limit, 127
High scaling factor, 98
High select, 97
Hysteresis (output relay), 122

I, J

Input 1 actuation type, 112
Input 1 high range value, 113
Input 1 low range value, 114
Input 1/Input 2 connections, 20
Input 2 actuation type, 116
Input 3 actuation type, 117
Input algorithm selections, 183
Integration rates, 184
Internal Cascade control, 172
Internal cascade indication, 180

K

Key functions, 4

L

Line voltage wiring, 19
Local setpoint source, 119, 125, 160
Lockout, 82
Loop 1 Control Parameters Set Up Group, 118
Loop 1 Tuning Parameters Set Up Group, 80
Loop break, 140
Loopback, 138
Low scaling factor, 98
Low select, 97
Lower display key, 153

M, N

Maintenance
 counters, 71, 144
 timers, 71, 144
Maintenance Group, 71
Manual mode, 158
Manual reset, 81
Manual tuning formulas, 275
Manual tuning procedure, 274
Manual/Auto key lockout, 82
Mass flow orifice constant (K) for math selections, 98
Math algorithms, 96, 183
Monitoring two-loop control, 180
Mounting
 Overall dimensions, 13

Mounting method, 14
Mounting procedure, 14
Multiplier, 97
Multiplier divider, 97
Multiplier divider with square root, 97
Multiplier with square root, 97

O

Open Collector Output Connections, 25
Operating limits, 8
Operating parameters, 153
Operation of two-loop control, 181
Operator interface, 3
Options Set Up Group, 129
Output algorithm, 109, 111
Output change rate, 121, 127
Output override, 181
Output override (2 PID loops only), 153
Output Override, 95
Output rate down value, 121, 127
Output rate up value, 121, 127
Override selector, 175
Oxygen, 98

P, Q

Parity, 136
PD with manual reset, 93, 95
Percent carbon source, 99
Physical considerations, 13
PID A, 93, 95
PID B, 93, 95
PID loop selection, 94
Position proportional backup mode, 159
Position Proportional control output calibration, 236
Position proportional output connections, 28
Power up, 148
Printed wiring board identification, 265
Printed wiring board removal, 264
Process gain Loop 2, 90
Program record sheet, 210
Program state, 207
Program termination state, 207
Prompt hierarchy, 36
Proportional band, 80
Proportional band 2, 81
Proportional band units, 123
Protective bonding, 15
PV Tuning, 47

R

Ramp segments, 206
Ramp unit, 208
Ramp/Soak profile, 205
Ramp/Soak profile example, 209
Ramp/Soak programming, 205
Range values, 220
Rate, 80
Rate 2, 81
Ratio, 114
Recycle number, 206
Relative humidity, 97, 99

Index

Relay Output, 22
Remote mode switching, 181
Remote setpoint, 162
Remote setpoint source, 120, 126
Remote switching, 186
Reset, 81
Reset 2, 81
Reset totalizer value, 187
Reset units, 123
Restarting a running SP program, 217
Restoring factory calibration, 231
Restrictions for two-loop control, 175
Reverse acting control, 121, 127
RS422/485 Communications board, 268
Run/Hold key lockout, 82
Run/monitor SP program, 214

S

Security code, 82
Set Up Group, 36
Setpoint high limit, 121, 126
Setpoint low limit, 121, 126
Setpoint ramp, 85
Setpoint ramp final setpoint, 86
Setpoint Ramp Set Up group, 45
Setpoint ramp time, 85
Setpoint Ramp/Rate/Programming Set Up Group, 85
Setpoint rate, 45, 86
Setpoint Select key lockout, 82
Setpoint selection indication, 162
Setpoint tracking, 120
Setpoint tracking, 126
Shed controller mode and output level, 137
Shed time, 136
Shock hazard warning, 219, 233, 253
Single Setpoint Ramp, 45
Soak segments, 206
Software version, 246
Solid State Relay Output Connections, 23
SP programming tips, 217
SP Tuning, 47
Start segment number, 206
Summer with ratio and bias, 97

T, U, V

Three Position Step, 94
Three Position Step Control algorithm, 182
Time duplex, 109
Time proportional output, 109
Time simplex, 109
Timer, 96
Totalizer displays, 184
Totalizer function, 107, 184
Totalizer reset via digital input, 185
Transmitter characterization, 113
Tuning 2 Set Up group, 44
Tuning constant values, 169
Tuning parameter sets, 118
Tuning parameter sets—Loop 2, 124
Tuning parameters, 179
Two HLAI replace second LLAI connections, 21

W, X, Y, Z

WARNING—SHOCK HAZARD, 219, 233, 253
Weighted average ratio, 98
Wiring diagram, 18

Index

Honeywell

Sensing and Control
Honeywell
11 West Spring Street
Freeport, IL 61032

51-52-25-55 Rev. D 0400 Printed in USA

www.honeywell.com/sensing

Download from Www.Somanuals.com. All Manuals Search And Download.

Free Manuals Download Website

<http://myh66.com>

<http://usermanuals.us>

<http://www.somanuals.com>

<http://www.4manuals.cc>

<http://www.manual-lib.com>

<http://www.404manual.com>

<http://www.luxmanual.com>

<http://aubethermostatmanual.com>

Golf course search by state

<http://golfingnear.com>

Email search by domain

<http://emailbydomain.com>

Auto manuals search

<http://auto.somanuals.com>

TV manuals search

<http://tv.somanuals.com>