

DCP200 Graphical Profiler Controller with optional Recorder



51-52-25-150

Issue 1

April 2009

This manual supplements the Concise Product manual(s) supplied with each instrument at the time of shipment. Information in this installation, wiring and operation manual is subject to change without notice.

Copyright © Honeywell Inc, April 2009, all rights reserved. No part of this publication may be reproduced, transmitted, transcribed or stored in a retrieval system, or translated into any language in any form by any means without the written permission of Honeywell Inc.

Copies of this manual are available in electronic format on the Honeywell web site www.honeywell.com/ps. Printed versions are available from Honeywell or its representatives.

Note:

It is strongly recommended that applications incorporate a high or low limit protective device, which will shut down the equipment at a preset process condition in order to prevent possible damage to property or products.



WARNING:

THE INTERNATIONAL HAZARD SYMBOL IS INSCRIBED ADJACENT TO THE REAR CONNECTION TERMINALS. IT IS IMPORTANT TO READ THIS MANUAL BEFORE INSTALLING OR COMMISSIONING THE UNIT.

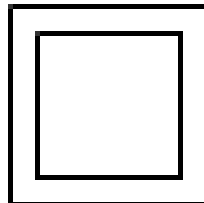

WARNING:

THIS SYMBOL MEANS THE EQUIPMENT IS PROTECTED THROUGHOUT BY DOUBLE INSULATION.

Products covered by this manual are suitable for Indoor use, Installation Category II, Pollution category 2 environments.

This user guide covers all versions of the Honeywell DCP200 Profile controller & Recorder.

Warranty and Returns Statement

These products are sold by Honeywell Inc under the warranties set forth in the following paragraphs. Such warranties are extended only with respect to a purchase of these products, as new merchandise, directly from Honeywell or from a Honeywell distributor, representative or reseller and are extended only to the first buyer thereof who purchases them other than for the purpose of resale.

Warranty

These products are warranted to be free from functional defects in material and workmanship at the time the products leave the factory and to conform at that time to the specifications set forth in the relevant Honeywell manuals sheet or sheets, for such products for a period of 18 months.

THERE ARE NO EXPRESSED OR IMPLIED WARRANTIES, WHICH EXTEND BEYOND THE WARRANTIES HEREIN AND ABOVE SET FORTH. NO WARRANTY IS MADE OF MERCHANTABILITY OR FITNESS FOR A PARTICULAR PURPOSE WITH RESPECT TO THE PRODUCTS.

Limitations

Honeywell shall not be liable for any incidental damages, consequential damages, special damages, or any other damages, costs or expenses excepting only the cost or expense of repair or replacement as described above. Products must be installed and maintained in accordance with Honeywell's instructions. There is no warranty against damage to the product resulting from corrosion. Users are responsible for the suitability of the products to their application.

For a valid warranty claim, the product must be returned carriage paid to the supplier within the warranty period. The product must be properly packaged to avoid damage from Electrostatic Discharge or other forms of harm during transit.

Contacts

World Wide Web

The following lists Honeywell's World Wide Web sites that will be of interest to our customers. Honeywell Organization WWW Address (URL)

Corporate <http://www.honeywell.com>

Honeywell Field Solutions <http://www.honeywell.com/ps>

Technical tips <http://content.honeywell.com/ipc/faq>

Telephone

Contact us by telephone at the numbers listed below.

Organization Phone Number

United States and Canada Honeywell 1-800-423-9883

Tech. Support 1-800-525-7439 Service

How to use this manual

This manual is structured to give easy access to the information required for all aspects of the installation and use and of the Graphical Controller. The main sections are shown here, followed by a full table of contents.

- Section 1: **Introduction** - A brief description of the product and it's features.
- Section 2: **Installation** - Unpacking, installing and panel mounting instructions.
- Section 3: **Field Upgrade Options** - Installation of the plug-in option modules.
- Section 4: **Wiring Instructions** - Guidance on good wiring practice, noise avoidance, wiring diagrams and input/output connections.
- Section 5: **Powering Up** - Powering up procedure and descriptions of displays & switches.
- Section 6: **Messages & Error Indications** - Display Messages and fault indications.
- Section 7: **Configuration & Use** - Describes operating and configuration modes available. These include Operation Mode; the Main and Configuration menus; the Easy Setup Wizard; Supervisor Mode; Automatic tuning; Product and Service Information. Also available on some models are menus to setup the USB, Data Recorder and Profiler features.
- Section 8: **The USB Interface Option** – Describes uploading or downloading of instrument settings, profiles or recorder logs to a USB memory stick.
- Section 9: **The Data Recorder Option** – Describes the Data recorder feature. This allows process data to be stored in to memory for later download and analysis.
- Section 10: **Profiler** – Describes the Profiler feature. A profile controls the value of the setpoint over time; increasing, decreasing or holding its value as required.
- Section 11: **Manually Tuning** - Advice on manually adjusting the controller to the process characteristics.
- Sections 12: **Serial Communications** - Details the physical layer and message formats used for the RS485 and Ethernet communications options.
- Sections 13: **Modbus Parameters** - Details the parameter addresses and data formats used for the Modbus RTU and TCP communications protocols.
- Section 14: **Calibration** - Step-by-step instructions to calibrate the instrument. This section is intended for use by suitably qualified personnel.
- Appendix 1: **Glossary** - Explanations of the terms used and product features.
- Appendix 2: **PC Software** – Using the software suite.
- Appendix 3: **Specifications** - Technical specifications for all products in the range.
- Appendix 4: **Product Coding** - Product model/ordering codes.

Contents

Page Number:

Warranty and Returns Statement	iv
1 Introduction	14
2 Installation	15
Unpacking	15
Installation	15
Panel-Mounting	15
Cleaning	16
3 Field Upgrade Options	17
Options Modules and Functions.....	17
Preparing to Install or Remove Options Modules.....	18
Removing/Replacing Option Modules	19
Replacing the Instrument in its Housing	20
Auto Detection of Option Modules.....	20
Replacement of Power Supply or Input Boards	20
Data Recorder Board.....	21
4 Electrical Installation	22
Installation Considerations	22
AC Power Wiring - Neutral (for 100 to 240V AC versions)	22
Wire Isolation.....	22
Use of Shielded Cable	23
Noise Suppression at Source.....	23
Sensor Placement (Thermocouple or RTD).....	24
Thermocouple Wire Identification Chart	24
Connections and Wiring.....	25
Power Connections	26
Universal Input Connections	27
Option Slot 1 Connections	29
Option Slot 2 Connections	30
Option Slot 3 Connections	32
Option Slot A Connections.....	35
Option Slot B Connections.....	36
5 Powering Up	37
Powering Up Procedure.....	37
Front Panel Overview	37
Display	37
LED Functions.....	38
Keypad.....	38
6 Messages and Error Indications	39
Start-up Errors.....	39

	Input Problems	39
	USB Data Transfer Problems.....	40
	Getting Help	40
7	Configuration and Use	41
	Operation Mode.....	41
	Base, Trend & Profile Operating Screens.....	41
	Adjusting the Local Setpoint(s)	43
	Adjusting the Setpoint Ramp Rate	44
	Selecting Automatic or Manual Mode.....	44
	Control Enable or Disable	44
	Main Menu.....	45
	Entry into the Main Menu	45
	Unlock Codes	45
	Setup Wizard.....	46
	Manual entry to the Setup Wizard	46
	Supervisor Mode	47
	Entry into Supervisor Mode.....	47
	Configuration Menu	48
	Entry into the Configuration Menu.....	48
	Input Configuration Sub-Menu	49
	Control Configuration Sub-Menu.....	50
	Output Configuration Sub-Menu.....	52
	Alarm Configuration Sub-Menu	53
	Communications Configuration Sub-Menu	53
	Recorder Configuration Sub-Menu.....	54
	Clock Configuration Sub-Menu	55
	Display Configuration Sub-Menu.....	55
	Lock Code View.....	56
	Lost Lock Codes.....	56
	Resetting To Defaults	57
	Automatic Tuning Menu	57
	Profiler Setup Menu	58
	Profiler Control Menu	61
	USB Menu	62
	Recorder Menu.....	63
	Product Information Mode.....	63
	Service Information Mode	64
8	The USB Interface.....	65
	Using the USB Port.....	65
	USB Memory Stick Folders & Files	65
9	The Data Recorder Option	66

	Introduction	66
	Changes To Operation Mode.....	66
10	The Profiler Option.....	67
	Profile Components.....	67
	Profile Starting & Standard Segments.....	68
	Loops Segments.....	69
	Profile Running / Holding vs. Hold Segments	69
	The Auto-Hold Feature	70
	Profile Cycles & Repeat Sequences.....	71
	Power/Signal Lost Recovery Actions.....	71
	Profile End Actions	72
	Profile Abort Actions	73
11	Manually Tuning Controllers	74
	Single Control Tuning (PID with Primary Output only)	74
	Dual Control Tuning (PID with Primary and Secondary Outputs)	75
	PI Tuning (Valve, Damper & Speed Controllers)	75
	Fine Tuning.....	77
12	Serial Communications.....	78
	Supported Protocols	78
	RS485 Configuration	78
	Ethernet Configuration.....	78
	Supported Modbus Functions	80
	Function Descriptions	80
	Exception Responses.....	82
13	Modbus Parameters	83
	Example Register Address Calculations	83
	Universal Process Input Parameters.....	84
	Option Slot A Parameters	86
	Option Slot B Parameters	87
	Option Slot 1 Parameters.....	88
	Option Slot 2 Parameters.....	90
	Option Slot 3 Parameters.....	93
	Option Slot 4 Parameters.....	96
	Setpoint Parameters.....	101
	Control Parameters.....	102
	Alarm parameters.....	104
	Recorder & Clock Parameters.....	106
	Display Parameters	109
	Profiler Control & Status Parameters	112
	Profile Setup Via Modbus	114
	Instrument Data.....	129

14	Calibration	130
	Calibration Reminder	130
	Equipment Required For Checking or Calibrating The Universal Input.....	130
	Calibration Check	130
	Recalibration Procedure	131
15	Appendix 1 – Glossary of Terms Used	132
	Active Setpoint.....	132
	Actual Setpoint	132
	Alarm Configuration	132
	Alarm Operation	134
	Alarm Inhibit	135
	Alarm Types	135
	Alternative Setpoint.....	135
	Auto Pre-Tune	135
	Automatic Reset	135
	Auxiliary Input.....	136
	Auxiliary Input Lower Limit	136
	Auxiliary Input Offset.....	136
	Auxiliary Input Type	136
	Auxiliary Input Upper Limit	136
	Band Alarm Value.....	136
	Bar Graphs	137
	Bias (Manual Reset)	137
	Bumpless Transfer.....	137
	Cascade Control	137
	Clock Configuration	138
	Communications Write Enable.....	138
	Configuration Menu	138
	Contactor.....	138
	Control Configuration	138
	Control Deviation	139
	Control Action.....	139
	Control Enable/Disable	139
	Control Type.....	139
	Controller.....	139
	Controller Mode.....	139
	Correcting Variable	139
	CPU	140
	Current Proportioning Control	140
	Custom Display Mode.....	140
	Cycle Time	140

Data Recorder	140
Deadband	140
Derivative Action.....	140
Deviation Alarm Value	141
Digital Input	141
Direct Acting Control.....	141
Display Configuration.....	141
Display Languages	141
Display Resolution.....	142
Effective Setpoint.....	142
Engineering Units	142
Ethernet.....	142
Indicator	142
Input Configuration	142
Input Filter Time Constant.....	142
Input Range.....	143
Input Span.....	143
Integral Time Constant.....	143
Latching Relay.....	143
LED	143
Linear Input	143
Linear Output.....	144
Limit Controller	144
Local Setpoints.....	144
Lock Codes	144
Logical Combination of Alarms.....	144
Loop Alarm	145
LSD	145
mADC	145
Main Menu	146
Manual Loop Alarm Time.....	146
Manual Mode.....	146
Master & Slave Controllers	146
Minimum Duration Of Change.....	147
Modbus RTU	147
Modbus TCP	147
Modulating Valve.....	148
Multi-Point Scaling.....	148
mVDC	148
On-Off Control	148
On-Off Differential (On-Off Hysteresis).....	148

Operation Mode.....	149
Output Configuration.....	149
Overlap/Deadband.....	149
PD Control.....	151
PI Control	151
PID Control.....	151
PLC.....	151
Pre-Tune	151
Power Output Limits	152
Primary Proportional Band.....	153
Process High Alarm <i>n</i> Value	153
Process Input	153
Process Low Alarm <i>n</i> Value	153
Process Variable (PV).....	153
Process Variable Offset	154
Profile Control Menu	154
Profile Events	154
Profile Header.....	154
Profile Segments	154
Profile Setup Menu	154
Profiler.....	155
Profiler Mode	155
Proportional Control.....	155
Rate	155
Rate Of Change Alarm.....	155
Recorder Configuration.....	155
Recorder Option	156
Recorder Menu.....	156
Relay.....	156
Remote Setpoint (RSP)	156
Retransmit Output.....	156
Retransmit Output <i>n</i> Scale Maximum	156
Retransmit Output <i>n</i> Scale Minimum	157
Reset To Defaults.....	157
Reverse Acting Control	157
RS485	157
RTD.....	158
Scale Range Upper Limit	158
Scale Range Lower Limit	158
Secondary Proportional Band	158
Self-Tune.....	159

	Sensor Break Pre-Set Power	159
	Serial Communications Configuration	160
	Serial Communications Option.....	160
	Setpoint.....	160
	Setpoint Upper Limit	160
	Setpoint Lower Limit	160
	Setpoint Ramp Editing.....	160
	Setpoint Ramp Rate	161
	Setpoint Selection.....	161
	Setup Wizard.....	161
	Solid State Relay (SSR).....	161
	Solenoid Valve	162
	Supervisor Mode	162
	Thermocouple	162
	Three Point Stepping Control.....	162
	Time Proportioning Control	163
	Trend Display	163
	Tuning.....	163
	Tuning Menu	163
	Triac.....	164
	USB Menu.....	164
	Valve Motor Drive Control (VMD).....	164
	VDC	164
	VMD.....	164
16	PC SOFTWARE.....	165
	Using The Software	165
	Instrument Configuration.....	166
	Profile Creation And Editing.....	167
	Changing the Start-up Splash Screen.....	169
	Changing the Alternate Display Language	169
	Instrument Simulation.....	169
	Configuring The Connection	169
	Network Configuration For Modbus TCP Options.....	171
17	Appendix 2 - Specifications.....	173
	Universal Process Input.....	173
	General Input Specifications.....	173
	Thermocouple Input.....	173
	Resistance Temperature Detector (RTD) Input	174
	DC Linear Input.....	175
	Auxiliary Inputs.....	175
	Digital Inputs.....	176

Output Specifications.....	177
Communications.....	179
Display	180
Control Loop.....	180
Data Recorder Option.....	180
Profiler Option.....	181
Alarms.....	181
Conditions For Use	182
Standards.....	182
Dimensions.....	182
18 Appendix 3 - Product Coding.....	183

1 Introduction

This product is a 1/4 DIN size (96 x 96mm front) microprocessor based graphical process controller, featuring a 160 x 80 pixel, monochrome LCD with a dual colour (red/green) backlight. It can control process variables from a variety of sources such as temperature, pressure, flow and level.

The operating voltage is either 100-240V at 50/60 Hz or 24V-48V AC/DC depending on the model purchased. Optional features include a USB interface, RS485 or Ethernet communications, profile controlling and data recording. Non-volatile memory protects against data or configuration loss during power outages. If the unit is left un-powered, a lithium battery powers the data recorder's real-time clock for a minimum of one year.

The USB Interface option allows uploading or downloading instrument configuration settings to/from a USB memory stick, for easy configuration of multiple instruments or transfer to/from the PC configuration software. If the Data Recorder or Profiler options are fitted, recordings and profile information can also be transferred via the memory stick.

The Data Recorder option allows the user to make recordings of the process over time. Recordings can be transferred to a memory stick using the USB Port or downloaded using one of the communications options.

The Profiler option allows the user to predefine up to 255 segments, shared amongst up to 64 Setpoint Profiles. These control the setpoint level over time, increasing, decreasing or holding its value as required. When combined with the real-time clock of the Data Recorder option, the profiling capabilities are expanded to allow automatic program start at a defined time and day.

Inputs are user configurable for thermocouple and RTD probes, as well as linear process signal types such as mVDC, VDC or mADC. Multipoint scaling can compensate for non-linear signals. Output options include relays, SSR drivers, triacs or linear mV/voltage modules. These can be used for process control, alarms or retransmission of the process variable or setpoint to external devices. Transmitter Power Supply options can provide an unregulated 24V DC (22mA) auxiliary output voltage, or a 0 to 10VDC stabilised excitation for external signal transmitters.

Alarm indication is standard on all instruments; up to five alarms can be defined. Alarms may be set as process high or low, deviation (active above or below controller setpoint), band (active both above and below setpoint), rate of input change, control loop or signal break types. Alarm status can be indicated by lighting an LED, changing the display backlight colour or viewing the alarm status screen. These alarms can be linked to any suitable output.

The controller can be programmed for on-off, time proportioning, or current proportioning control implementations, depending on the output modules fitted, and feature manual or automatic tuning of the PID parameters. A secondary control output is available when additional output modules are fitted. Optional analogue Remote Setpoint inputs can be included. Configuration of the major settings is made easy by a Setup Wizard that runs automatically at first ever power-up or whenever option modules have been changed. Access to the full range of parameters is via a simple menu driven front panel interface, or the PC based configuration software.

2 Installation

Unpacking

1. Remove the product from its packing. Retain the packing for future use, in case it is necessary to transport the instrument to a different site or to return it to the supplier for repair/testing.
2. The instrument is supplied with a panel gasket and push-fit fixing strap. Concise manual(s) are supplied with the instrument, in one or more languages. Examine the delivered items for damage or defects. If any are found, contact your supplier immediately.

Installation

CAUTION:

Installation should only be performed by technically competent personnel. It is the responsibility of the installing engineer to ensure that the configuration is safe. Local Regulations regarding electrical installation & safety must be observed (e.g. US National Electrical Code (NEC) or Canadian Electrical Code).

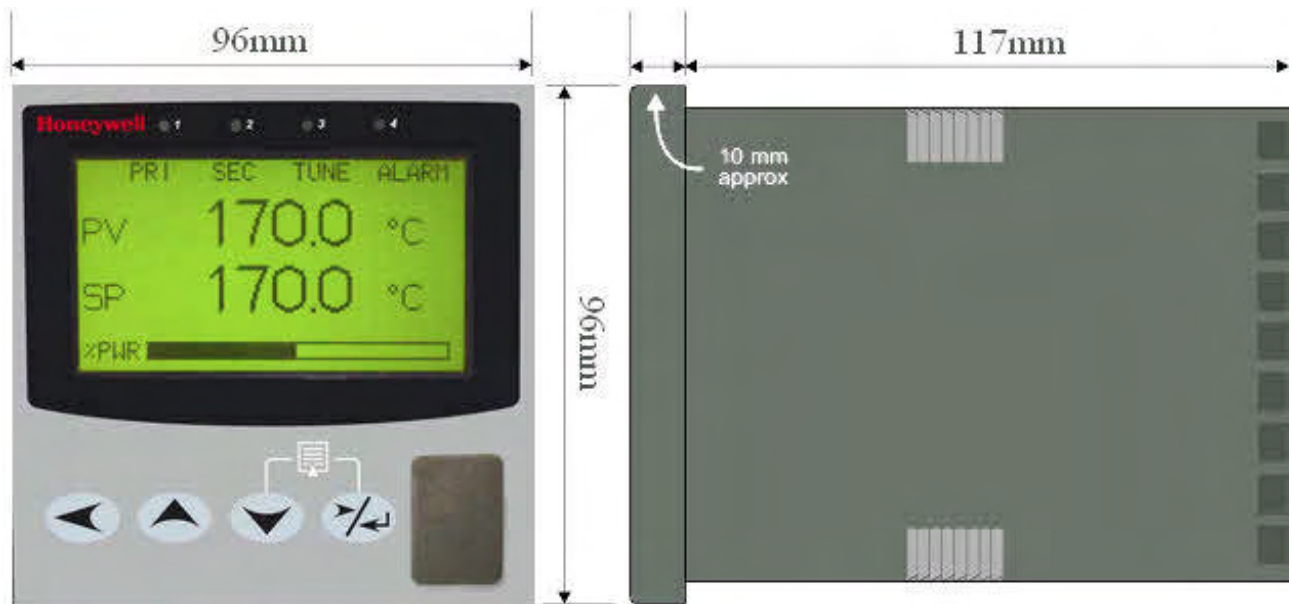

Figure 1. Main dimensions

Panel-Mounting

The mounting panel must be rigid and may be up to 6.0mm (0.25 inches) thick. The cut-out size is:

92mm x 92mm (+0.5mm / -0.0mm).

Instruments may be mounted side-by-side in a multiple installation, but instrument to panel moisture and dust sealing will be compromised. Allow a 20mm gap above, below and behind the instrument for ventilation. The cut-out width (for n instruments) is:

$$(96n - 4) \text{ mm or } (3.78n - 0.16) \text{ inches}$$

If panel sealing must be maintained, mount each instrument into an individual cut-out with 6mm or more clearance between the edges of the holes.

Note:

The mounting clamp tongues may engage the ratchets either on the sides or the top/bottom faces of the Instrument housing. When installing several Instruments side-by-side in one cut-out, use the ratchets on the top/bottom faces.

CAUTION:

Ensure the inside of the panel remains within the instrument operating temperature and that there is adequate airflow to prevent overheating.

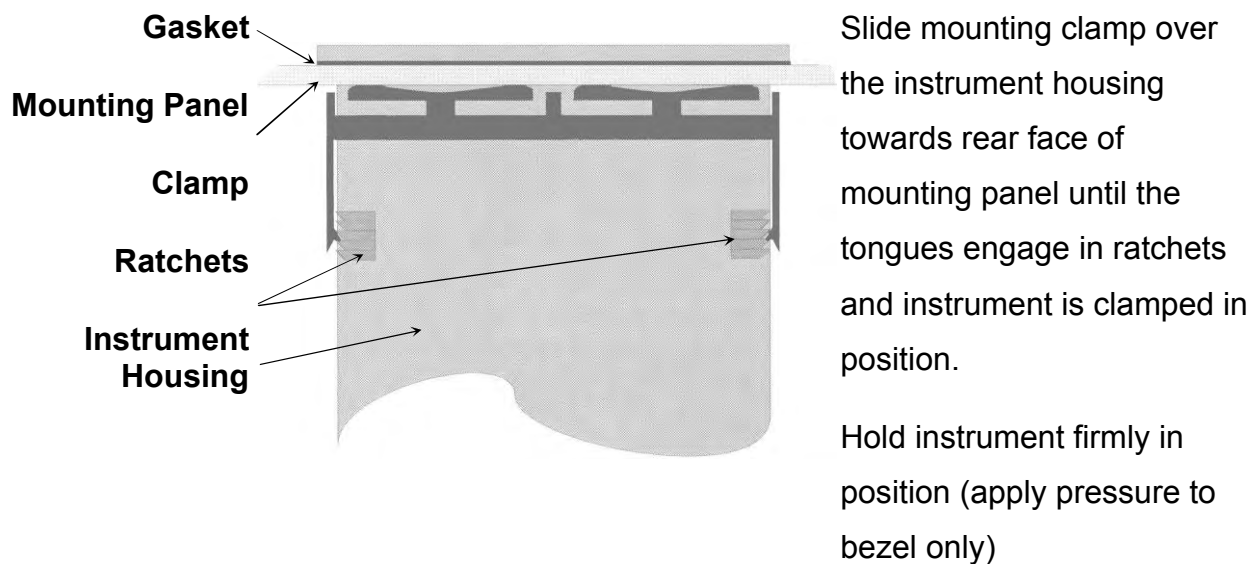

Figure 2. Panel-Mounting the instrument

CAUTION:

Do not remove the panel gasket, as this may result in inadequate clamping and sealing of the instrument to the panel.

Once the instrument is installed in its mounting panel, it may be subsequently removed from its housing, if necessary, as described in the Fitting and Removing Option Modules section.

Cleaning

Clean the front panel by washing with warm soapy water and dry immediately. If the USB option is fitted, close the USB port cover before cleaning.

3 Field Upgrade Options

Options Modules and Functions

The available plug-in modules, options and accessories are shown in below:

Table 1. Options & Accessories

PART NUMBER	DESCRIPTION	BOARD IDENTIFICATION NUMBER
OPTION SLOT 1		
51453391-517	Single Relay Output for option slot 1	716/01
51453391-502	Single SSR Driver Output for option slot 1	716/02
51453391-503	Triac Output for option slot 1	716/03
51453391-504	Linear mA / Voltage Output module for option slot 1	639/01
OPTION SLOT 2 or 3		
51453391-518	Single Relay Output for option slot 2 or 3	717/01
51453391-510	Dual Relay Output for option slot 2 or 3	644/01
51453391-507	Single SSR Driver Output for option slot 2 or 3	717/02
51453391-519	Dual SSR Driver Output for option slot 2 or 3	644/02
51453391-508	Triac module Output for slot 2 or 3	647/01
51453391-509	Linear mA / Voltage Output for option slot 2 or 3	640/01
51453391-111	24VDC Transmitter Power Supply for option slot 2 or 3	642/01
OPTION SLOT A		
51453391-513	Digital Input for option slot A	641/02
51453391-515	Basic Auxiliary Input for option slot A	653/01
51453391-512	RS485 Serial Communications for option slot A	680/01
51453391-521	Ethernet Communications for option slot A	707/01
OPTION SLOT B		
51453391-516	Full Auxiliary Input (inc digital input B) for option slot B	641/01
OPTION SLOT 4		
51453391-520	4-Relay Output for option slot 4	703/01
ACCESSORIES		
51453391-522	Blue Control PC Configuration Software & Lead	

Note:

Modules can be either pre-installed at the time of manufacture, or retrofitted in the field.

CAUTION:

Plastic pegs prevent fitting of older non-reinforced single relay modules (Board Identification Numbers 637/01 and 638/01). Fitting the older relay modules reduces the isolation rating to Basic 240V Isolation and is therefore not recommended. Remove this peg when fitting Dual Relay Modules.

Note:

All dual relay modules have reinforced isolation.

Board Positions

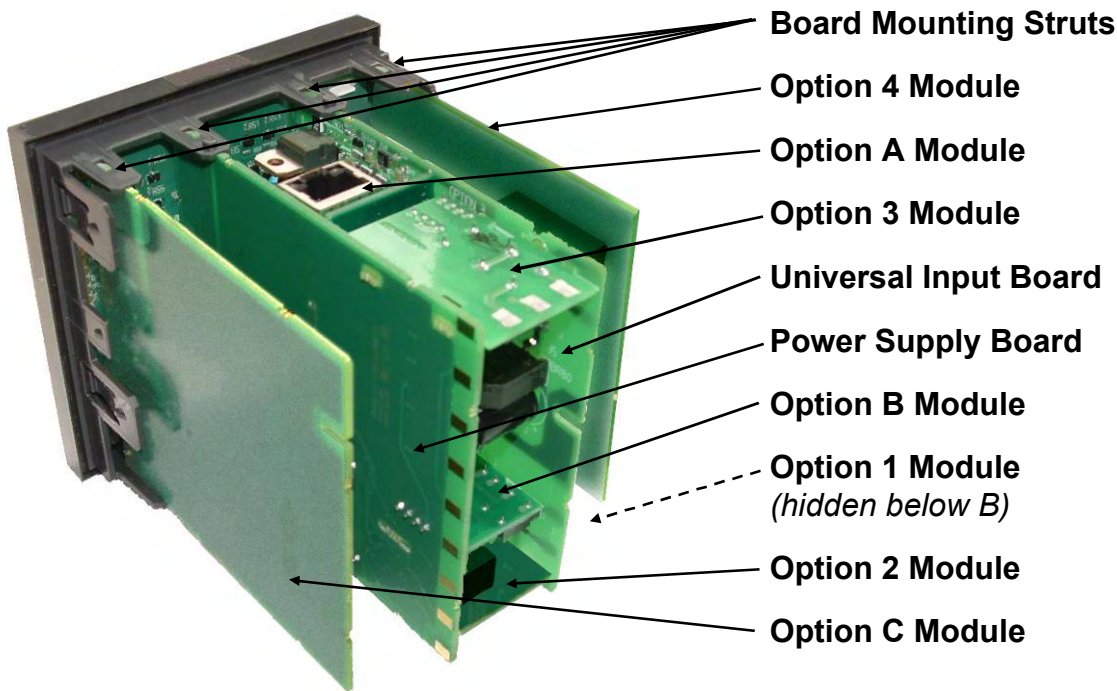

Figure 3. Rear view (uncased) & board positions

Preparing to Install or Remove Options Modules

CAUTION:

Before removing the instrument from its housing, ensure that all power has been removed from the rear terminals. Modules / boards should only be replaced by a trained technician.

1. Remove the instrument from its housing by gripping the edges of the front panel (there is a finger grip on each edge) and pull the instrument forwards. This will release the instrument from the rear connectors in the housing and will give access to the boards.
2. Take note of the orientation of the instrument for subsequent replacement into the housing. The positions of the boards in the instrument are shown above.

Main Board Connectors

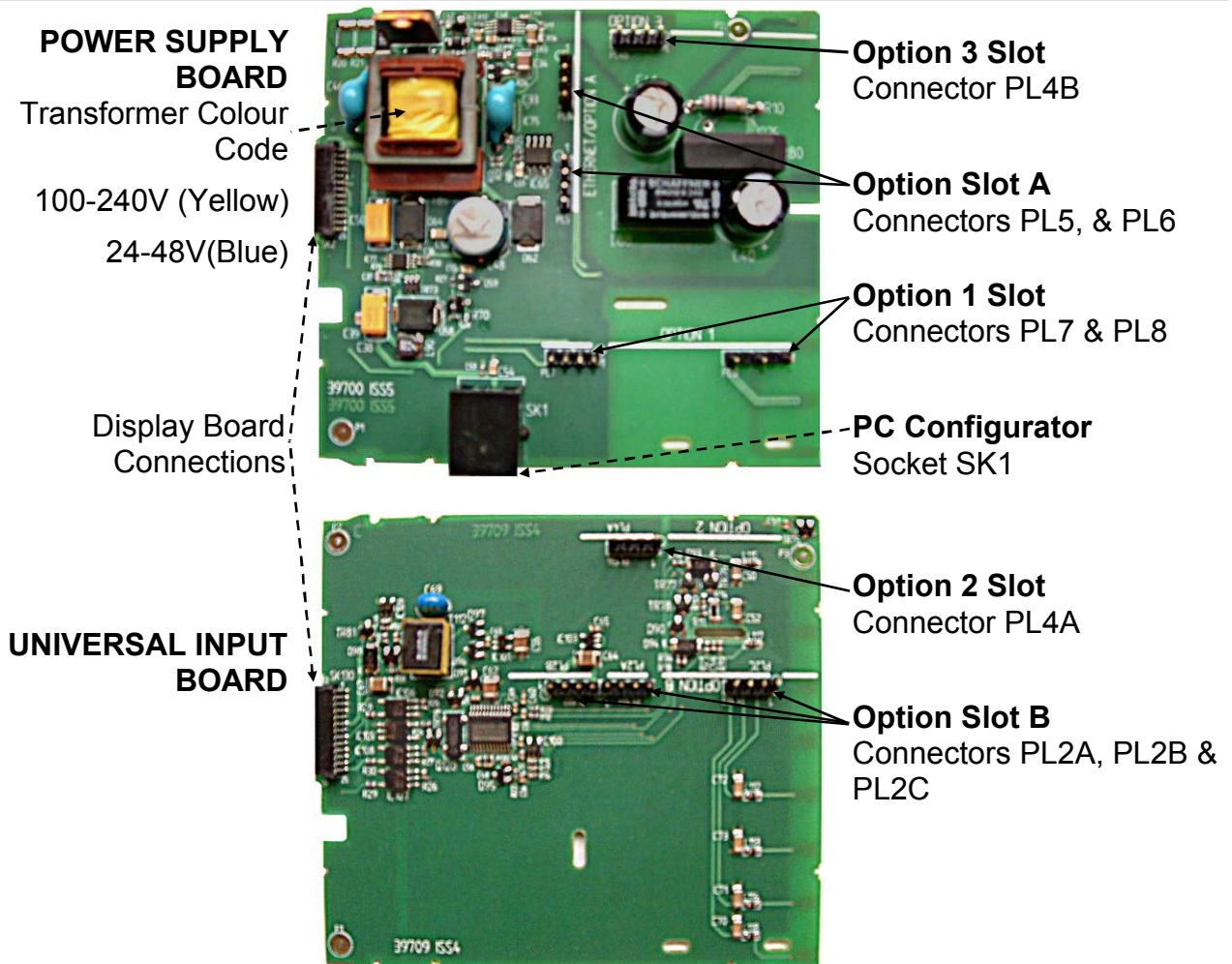

Figure 4. Main board connectors

Removing/Replacing Option Modules

1. To remove or replace modules in Option Slots 1, 2, 3, A or B, it is necessary to detach the Power Supply and Input boards from the front panel by lifting first the upper and then lower mounting struts.
2. Remove or fit the modules to the connectors on the Power Supply and Input boards. The location of the connectors is shown below. Plastic pegs prevent fitting of older non-reinforced single relay modules – *Remove the peg to fit dual relay modules*
3. Assemble the Power Supply and Input boards together. Tongues on each option module locate into a slots cut into the main boards, opposite each of the connectors. Hold the Power and Input boards together and relocate them back on their mounting struts.
4. Remove or replace the Slot C and 4 modules as required.
5. Push the boards forward to ensure correct connection to the front Display/CPU board.

CAUTION:

Check for correct orientation of the modules and that all pins are located correctly.

Replacing the Instrument in its Housing

CAUTION:

Before replacing the instrument in its housing, ensure that all power has been removed from the rear terminals.

With the required option modules correctly located into their respective positions the instrument can be replaced into its housing as follows:

1. Hold the Power Supply and Input boards together.
2. Align the boards with the guides in the housing.
3. Slowly and firmly, push the instrument in position.

CAUTION:

Ensure that the instrument is correctly orientated. A mechanical stop will operate if an attempt is made to insert the instrument in the wrong orientation, this stop MUST NOT be over-ridden.

Auto Detection of Option Modules

The instrument automatically detects which option modules have been fitted into each slot. The menus and screens change to reflect the options compatible with the hardware fitted. The modules fitted can be viewed in the products information menu, as detailed in the Product Information Mode section of this manual.

Replacement of Power Supply or Input Boards

It is recommended that users only change these boards if it is unavoidable..

1. Remove the instrument from its housing as detailed above.
2. Remove all option modules.
3. Replace the Power Supply or Input board as required. Carefully observe the transformer colour and the case labelling to **check the supply voltage** when replacing the power supply board.
4. Reassemble the unit in its case.
5. If the input board has to be replaced, a full recalibration **must** be carried out before the instrument is used. Refer to the calibration section of this manual for instructions.

CAUTION:

Replacement of boards must be carried out by a trained technician. If the Power Supply board does not match the labelling, users may apply incorrect voltage resulting in irreparable damage.

Data Recorder Board

If installed, the Data Recorder memory and Real Time Clock (RTC) components are located on a plug-in daughter board attached to the front Display/CPU board.

CAUTION:

Servicing of the Data Recorder/RTC circuit and replacement of the lithium battery should only be carried out by a trained technician.

4 Electrical Installation

CAUTION:

Installation should be only performed by technically competent personnel. It is the responsibility of the installing engineer to ensure that the configuration is safe. Local Regulations regarding electrical installation & safety must be observed (e.g. US National Electrical Code (NEC) or Canadian Electrical Code).

Installation Considerations

Ignition transformers, arc welders, motor drives, mechanical contact relays and solenoids are examples of devices that generate electrical noise in typical industrial environments. The following guidelines MUST be followed to minimise their effects.

1. If the instrument is being installed in existing equipment, the wiring in the area should be checked to ensure that good wiring practices have been followed.
2. Noise-generating devices such as those listed should be mounted in a separate enclosure. If this is not possible, separate them from the instrument, by the largest distance possible.
3. If possible, eliminate mechanical contact relays and replace with solid-state relays. If a mechanical relay being powered by an output of this instrument cannot be replaced, a solid-state relay can be used to isolate the instrument.
4. A separate isolation transformer to feed only the instrumentation should be considered. The transformer can isolate the instrument from noise found on the AC power input.

AC Power Wiring - Neutral (for 100 to 240V AC versions)

It is good practice to ensure that the AC neutral is at or near ground (earth) potential. A proper neutral will help ensure maximum performance from the instrument.

Wire Isolation

Four voltage levels of input and output wiring may be used with the unit:

1. Analogue input or output (for example thermocouple, RTD, VDC, mVDC or mADC)
2. Relays & Triac outputs
3. SSR Driver outputs
4. AC power

CAUTION:

The only wires that should run together are those of the same category.

If any wires need to run parallel with any other lines, maintain a minimum space of 150mm between them.

If wires MUST cross each other, ensure they do so at 90 degrees to minimise interference.

Use of Shielded Cable

All analogue signals must use shielded cable. This will help eliminate electrical noise induction on the wires. Connection lead length must be kept as short as possible keeping the wires protected by the shielding. The shield should be grounded at one end only. The preferred grounding location is at the sensor, transmitter or transducer.

Noise Suppression at Source

Usually when good wiring practices are followed, no further noise protection is necessary. Sometimes in severe electrical environments, the amount of noise is so great that it has to be suppressed at source. Many manufacturers of relays, contactors etc supply 'surge suppressors' which mount on the noise source. For those devices that do not have surge suppressors supplied, Resistance-Capacitance (RC) networks and/or Metal Oxide Varistors (MOV) may be added.

Inductive coils:- MOVs are recommended for transient suppression in inductive coils, connected in parallel and as close as possible to the coil. Additional protection may be provided by adding an RC network across the MOV.

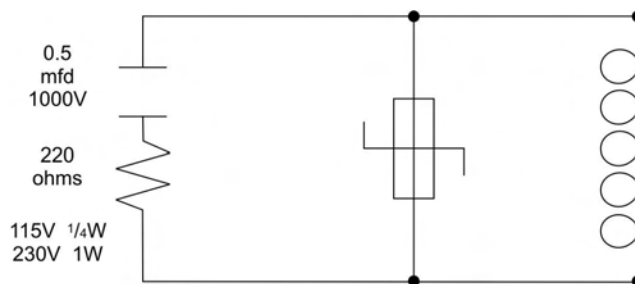

Figure 5. Transient suppression with inductive coils

Contacts:- Arcing may occur across contacts when they open and close. This results in electrical noise as well as damage to the contacts. Connecting a properly sized RC network can eliminate this arc.

For circuits up to 3 amps, a combination of a 47 ohm resistor and 0.1 microfarad capacitor (1000 volts) is recommended. For circuits from 3 to 5 amps, connect two of these in parallel.

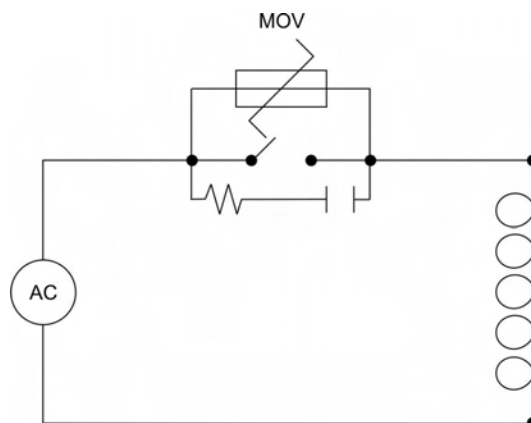

Figure 6. Contact noise suppression

Sensor Placement (Thermocouple or RTD)

If the temperature probe is to be subjected to corrosive or abrasive conditions, it must be protected by an appropriate thermowell. The probe must be positioned to reflect true process temperature:

1. In a liquid media - the most agitated area
2. In air - the best circulated area

CAUTION:

The placement of probes into pipe work some distance from the heating vessel leads to transport delay, which results in poor control.

For a two wire RTD, a wire link should be used in place of the third wire (see the wiring section for details). Two wire RTDs should only be used with lead lengths less than 3 metres. Use of three wire RTDs is strongly recommended to reduce errors do to lead resistance.

Thermocouple Wire Identification Chart

The different thermocouple types are identified by their wires colour, and where possible, the outer insulation as well. There are several standards in use throughout the world.

The table below shows the wire and sheath colours used for most common thermocouple types. The format used in this table is:

+ Wire	Sheath
- Wire	

Table 2. Thermocouple Extension Wire Colours

Type		International IEC584-3	USA ANSI MC 96.1	British BS1843	French NFC 42-324	German DIN 43710
J	+*	Black Black	White Black	Yellow Black	Yellow Black	Red Blue
	-	White Black	Red Black	Blue Black	Black Black	Blue Blue
T	+	Brown Brown	Blue Blue	White Blue	Yellow Blue	Red Brown
	-	White Brown	Red Blue	Blue Blue	Blue Blue	Brown Brown
K	+	Green Green	Yellow Yellow	Brown Red	Yellow Yellow	Red Green
	-*	White Green	Red Yellow	Blue Red	Purple Yellow	Green Green
N	+	Pink Pink	Orange Orange	Orange Orange		
	-	White Pink	Red Orange	Blue Orange		
B	+	Grey Grey	Grey Grey			Red Grey
	-	White Grey	Red Grey			Grey Grey
R & S	+	Orange Orange	Black Green	White Green	Yellow Green	Red White
	-	White Orange	Red Green	Blue Green	Green Green	White White
C (W5)	+		White White			
	-		Red White			

Note:

* = Wire is magnetic

The wiring diagram below shows the additional connections (numbered 25 to 42) at the sides of the case rear. These are required for Options Slots 4 and C if fitted.

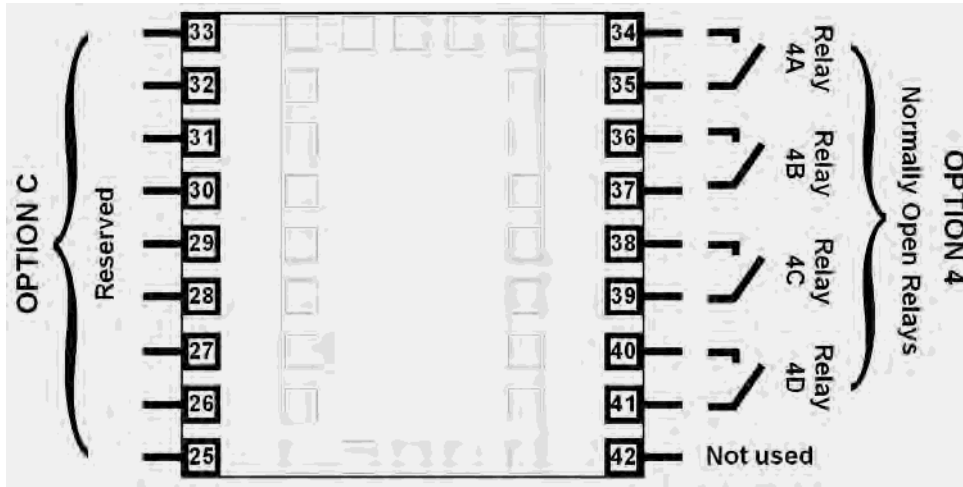

Figure 8. Additional Option terminals

Note:

Use single strand (1.2mm / AWG18 max size) copper wire throughout, except for the thermocouple input, where the correct thermocouple or compensating cable and connectors must be used.

Power Connections

Power Connections - Mains Powered Instruments

Mains powered instruments operate from a 100 to 240V (±10%) 50/60Hz supply. Power consumption is 24VA. Connect the line voltage (live and neutral) as illustrated via a two-pole IEC60947-1 & IEC60947-3 compliant isolation switch / circuit breaker and a UL listed fuse type: 250V AC 1Amp anti-surge. If the instrument has relay outputs with contacts carrying mains voltage, it is recommended that the relay contacts supply should be switched and fused in a similar manner, but should be separate from the instruments mains supply.

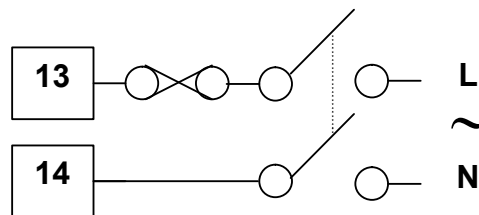

Figure 9. Mains Power Connections

WARNING:

CHECK THE INFORMATION LABEL ON THE CASE TO DETERMINE THE CORRECT VOLTAGE BEFORE CONNECTING TO A LIVE SUPPLY.

CAUTION:

This equipment is designed for installation in an enclosure that provides adequate protection against electric shock. The isolation switch should be located in close proximity to the unit, in easy reach of the operator and appropriately marked.

Power Connections - 24/48V AC/DC Powered Instruments

24/48V AD/DC powered instruments will operate from a 20 to 48V AC or 22 to 55V DC supply. AC power consumption is 15VA max, DC power consumption is 12 watts max. Connection should be via a two-pole IEC60947-1 & IEC60947-3 compliant isolation switch / circuit breaker and a UL listed fuse type: 65v dc 1Aamp anti-surge.

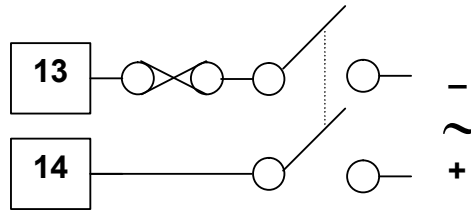

Figure 10. 24/48V AC/DC Power Connections

WARNING:

CHECK THE INFORMATION LABEL ON THE CASE TO DETERMINE THE CORRECT VOLTAGE BEFORE CONNECTING TO A LIVE SUPPLY.

CAUTION:

This equipment is designed for installation in an enclosure that provides adequate protection against electric shock. The isolation switch should be located in close proximity to the unit, in easy reach of the operator and appropriately marked.

Universal Input Connections

Universal Input Connections - Thermocouple (T/C)

Use only the correct thermocouple wire or compensating cable from the probe to the instrument terminals avoiding joints in the cable if possible. Where joints are made, special thermocouple connectors must be used. Failure to use the correct wire type and connectors will lead to inaccurate readings. Ensure correct polarity of the wires by cross-referencing the colours with a thermocouple reference table.

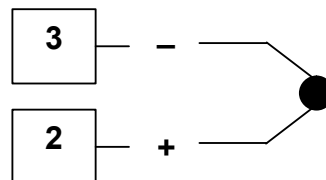

Figure 11. Thermocouple Input Connections

Universal Input Connections – PT100 / NI120 (RTD) input

For three wire RTDs, connect the resistive leg and the common legs of the RTD as illustrated. For a two wire RTD a wire link should be used in place of the third wire (shown by dotted line). Two wire RTDs should only be used when the leads are less than 3 metres long. Avoid cable joints.

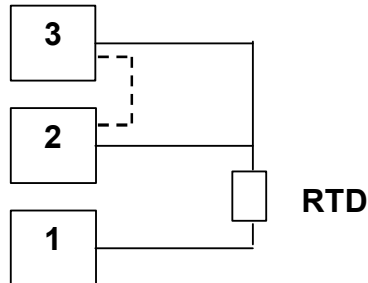

Figure 12. RTD Input Connections

Four wire RTDs can be used, provided that the fourth wire is left unconnected. This wire should be cut short or tied back so that it cannot contact any of the terminals on the rear of the instrument.

Universal Input Connections - Linear Volt, mV or mA input

Linear DC voltage, millivolt or milliamp input connections are made as illustrated. Carefully observe the polarity of the connections.

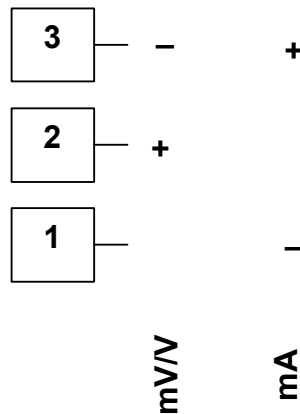

Figure 13. DC Volt, mV & mA Input Connections

Option Slot 1 Connections

Option Slot 1 – Single Relay Output Module

If option slot 1 is fitted with a single relay output module, make connections as illustrated. The relay contacts are SPDT and rated at 2 amps resistive, 240 VAC.

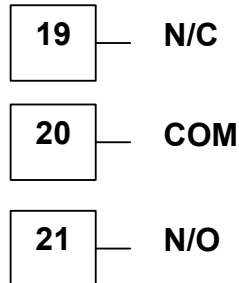

Figure 14. Option Slot 1 – Single Relay Module

Option Slot 1 – Single SSR Driver Output Module

If option slot 1 is fitted with a single SSR driver output module, make connections as illustrated. The solid-state relay driver is a 0-10V DC signal, load impedance must be no less than 500 ohms. SSR driver outputs are not isolated from the signal input or other SSR driver outputs.

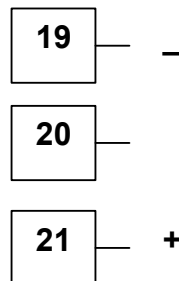

Figure 15. Option Slot 1 – Single SSR Driver Module

Option Slot 1 - Triac Output Module

If option slot 1 is fitted with a Triac output module, make connections as shown. This output is rated at 0.01 to 1 amp @ 280V AC 50/60Hz. A snubber should be fitted across inductive loads to ensure reliable switch off the Triac.

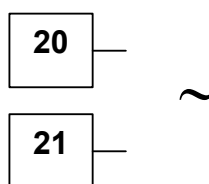

Figure 16. Option Slot 1 - Triac Module

Option Slot 1 - Linear Voltage or mADC Output module

If option slot 1 is fitted with a DC linear output module, make connections as illustrated.

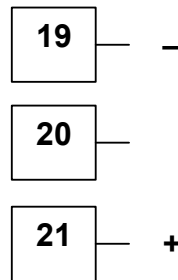

Figure 17. Option Slot 1 - Linear Voltage & mADC Module

Option Slot 2 Connections

Option Slot 2 – Single Relay Output Module

If option slot 2 is fitted with a single relay output module, make connections as illustrated. The relay contacts are SPDT, and rated at 2 amps resistive, 240 VAC.

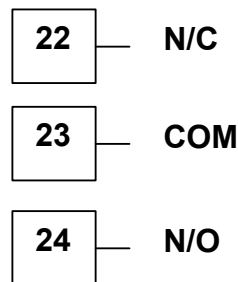

Figure 18. Option Slot 2 – Single Relay Module

Option Slot 2 - Dual Relay Output Module

If option slot 2 is fitted with a dual relay output module, make connections as illustrated. This module has two independent SPST relays, which share a common connection terminal. The contacts are rated at 2 amp resistive 240 VAC.

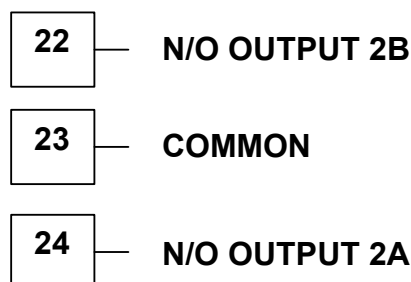

Figure 19. Option Slot 2 - Dual Relay Module

Option Slot 2 – Single SSR Driver Output Module

If option slot 2 is fitted with a single SSR driver output module, make connections as illustrated. The solid-state relay driver is a 0-10V DC signal, load impedance must be no less than 500 ohms. SSR driver outputs are not isolated from the signal input or other SSR driver outputs.

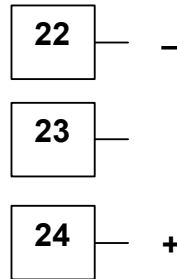

Figure 20. Option Slot 2 – Single SSR Driver Module

Option Slot 2 – Dual SSR Driver Output Module

If option slot 2 is fitted with a dual SSR driver output module, make connections as illustrated. The solid-state relay drivers are a 0-10V DC signal, load impedance must be no less than 500 ohms. SSR driver outputs are not isolated from the signal input or other SSR driver outputs.

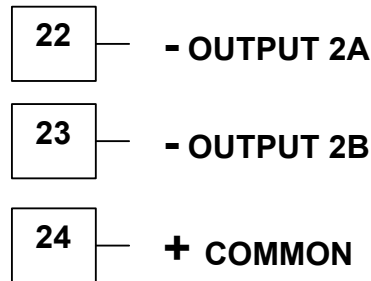

Figure 21. Option Slot 2 – Dual SSR Driver Module

Option Slot 2 - Triac Output Module

If option slot 2 is fitted with a Triac output module, make connections as shown. This output is rated at 0.01 to 1 amp @ 280V AC 50/60Hz. A snubber should be fitted across inductive loads to ensure reliable switch off the Triac.

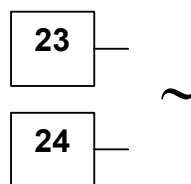

Figure 22. Option Slot 2 - Triac Module

Option Slot 2 - Linear Voltage or mADC Output module

If option slot 2 is fitted with a DC linear output module, make connections as illustrated.

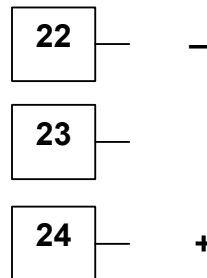

Figure 23. Option Slot 2 - Linear Voltage & mADC module

Option Slot 2 - Transmitter Power Supply Module

If option slot 2 is fitted with a transmitter power supply module, make connections as illustrated. The output is an unregulated 24V DC, 22mA supply.

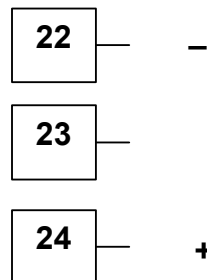

Figure 24. Option Slot 2 - Transmitter Power Supply Module

Option Slot 3 Connections

Option Slot 3 – Single Relay Output Module

If option slot 3 is fitted with a single relay output module, make connections as illustrated. The relay contacts are SPDT, and rated at 2 amps resistive, 240 VAC.

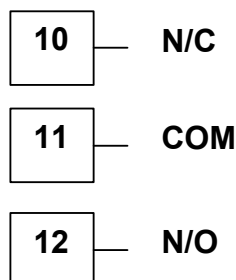

Figure 25. Option Slot 3 – Single Relay Module

Option Slot 3 - Dual Relay Output Module

If option slot 3 is fitted with a dual relay output module, make connections as illustrated. This module has two independent SPST relays, which share a common connection terminal. The contacts are rated at 2 amp resistive 240 VAC.

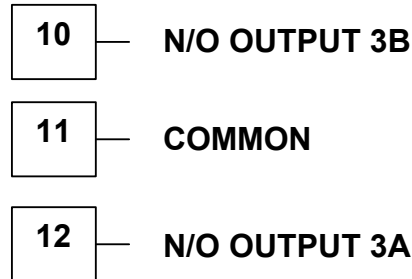

Figure 26. Option Slot 3 - Dual Relay Module

Option Slot 3 – Single SSR Driver Output Module

If option slot 3 is fitted with a single SSR driver output module, make connections as illustrated. The solid-state relay driver is a 0-10V DC signal, load impedance must be no less than 500 ohms. SSR driver outputs are not isolated from the signal input or other SSR driver outputs.

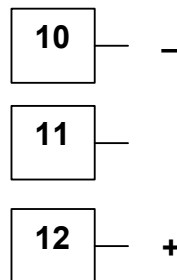

Figure 27. Option Slot 3 – Single SSR Driver Module

Option Slot 3 – Dual SSR Driver Output Module

If option slot 3 is fitted with a dual SSR driver output module, make connections as illustrated. The solid-state relay drivers are a 0-10V DC signal, load impedance must be no less than 500 ohms. SSR driver outputs are not isolated from the signal input or other SSR driver outputs.

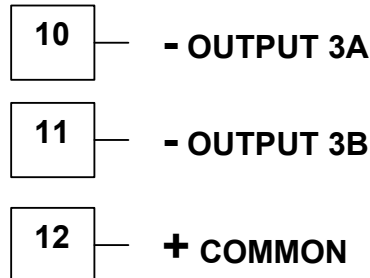

Figure 28. Option Slot 3 – Dual SSR Driver Module

Option Slot 3 - Triac Output Module

If option slot 3 is fitted with a Triac output module, make connections as shown. This output is rated at 0.01 to 1 amp @ 280V AC 50/60Hz. A snubber should be fitted across inductive loads to ensure reliable switch off the Triac.

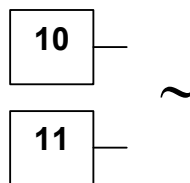

Figure 29. Option Slot 3 - Triac Module

Option Slot 3 - Linear Voltage or mADC Output module

If option slot 3 is fitted with a DC linear output module, make connections as illustrated.

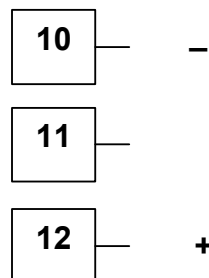

Figure 30. Option Slot 3 - Linear Voltage & mADC module

Option Slot 3 - Transmitter Power Supply Module

If option slot 3 is fitted with a transmitter power supply module, make connections as illustrated. The output is an unregulated 24V DC, 22mA supply.

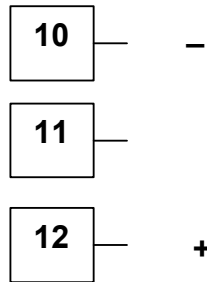

Figure 31. Option Slot 3 - Transmitter Power Supply Module

Option Slot A Connections

Option Slot A Connections – Basic Auxiliary Input Module

If option slot A is fitted with a basic auxiliary input module, connect as shown. Consider using the full auxiliary input (Option Slot B) instead, as this has additional features and leaves option slot A free for other modules.

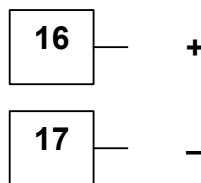

Figure 32. Option Slot A – Basic Auxiliary Input Module

Option Slot A Connections - Digital Input A Module

If a digital input module is fitted in option slot A, this may be connected to either voltage free contacts (e.g. switch or relay), or a TTL compatible voltage. Connections are shown below.

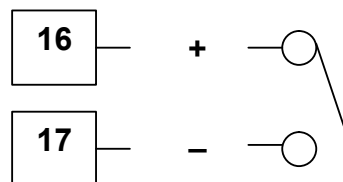

Figure 33. Option Slot A – Digital Input A Module

Option Slot A Connections - Ethernet Communications Module

If option slot A is fitted with the Ethernet communication module, a standard RJ45 connector is accessible from the top of case. No rear connections are required.

Option Slot A Connections - RS485 Serial Communications Module

If option slot A is fitted with the RS485 serial communication module, connections are as illustrated. Carefully observe the polarity of the A (Rx/Tx +ve) and B (Rx/Tx -ve) connections.

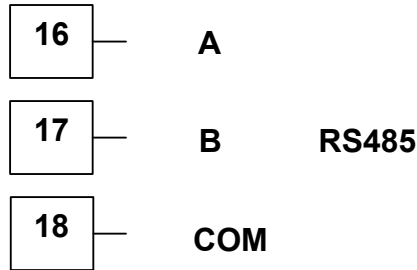

Figure 34. Option Slot A – RS485 Serial Communications Module

CAUTION:

External computing devices connected to the communications port should comply with the standard, UL 60950.

Option Slot B Connections

Option Slot B Connections – Digital Input B (Full Auxiliary Module)

If option slot B is fitted with the Full Auxiliary input module (see below), a secondary digital input is also provided. This may be connected to the voltage free contacts of a switch or relay, or to a TTL compatible voltage.

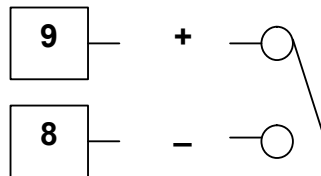

Figure 35. Option Slot B – Digital Input B Connections

Option Slot B Connections – Full Auxiliary Input B Module

If option slot B is fitted with full auxiliary input feature, input connections are as shown.

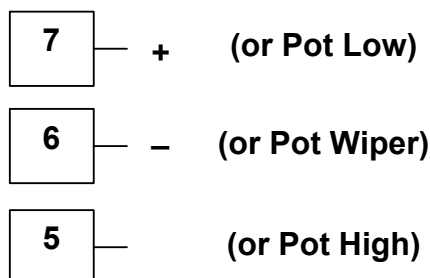

Figure 36. Option Slot B – Full Auxiliary Input Connections

5 Powering Up

CAUTION:

Ensure safe wiring practices have been followed. When powering up for the first time, disconnect the output connections.

The instrument must be powered from a supply according to the wiring label on the side of the unit. The supply will be either 100 to 240V AC, or 24/48V AC/DC powered. Check carefully the supply voltage and connections before applying power.

Powering Up Procedure

At power up, a self-test procedure is automatically started, during which a splash screen is displayed and the LED indicators are lit. At the first power up from new, or if the option modules are changed, the Setup Wizard will run, indicating that configuration is required (*refer to the Setup Wizard section of this manual*). At all other times, the instrument returns to Operation Mode once the self-test procedure is complete.

Front Panel Overview

The illustration below shows the instrument front panel. A USB socket fitted to USB and Data Recorder versions, to the right of the keypad.

Clean the front panel by washing with warm soapy water and dry immediately. If the USB option is fitted, close the USB port cover before cleaning.



Figure 37. Front panel and keys

Display

The instrument has a 160 x 80 pixel monochrome graphical display with dual colour (red/green) backlight. The main display typically shows the process variable and setpoint values or a graphical trend during normal operation. There are various bar graph, recorder status and profile status information options (*refer to the Display Configuration section for more details*). The top line of the display has labels for the 4 LED indicators. If desired, the backlight colour can be changed to indicate the presence of an active alarm.







LED Functions

There are four red LEDs that by default, indicate the status of the primary and secondary control outputs, automatic tuning and alarm status. The top line of the graphical display has four labels for LED indicators. The function of these LEDs and their display labels can be changed using the PC configuration software. The information in this manual assumes standard functions for these LEDs.

Keypad

Each instrument has four keypad switches, which are used to navigate through the user menus and adjust the parameter values. In configuration screens, a context sensitive scrolling help text is displayed that guides the user about the function of the keys.

Table 3. Keypad button functions

Button	Function
	<p>Moves backwards to the previous parameter or screen in the current mode. CAUTION: If editing a parameter, ensure that the current (highlighted) parameter value is correct before pressing the key as this action will update the instrument to the value displayed.</p>
	<p>In menus and configuration choice screens, this key moves to the next item on the list. Editable values can be decreased by pressing this key. Holding the key down speeds up the change. In Trend view this key moves the Cursor Line back through the stored data points</p>
	<p>In menus and configuration choice screens, this key moves to the previous item on the list. Editable values can be increased by pressing this key. Holding the key down speeds up the change. In Trend view this key moves the Cursor Line forward through the stored data points</p>
	<p>Moves forwards to the next parameter or screen in the current mode. CAUTION: If editing a parameter, ensure that the current (highlighted) parameter value is correct before pressing the key as this action will update the instrument to the value displayed.</p>
	<p>Pressing the  key while holding down the  key causes the instrument to move up one menu level. From Operation Mode and in most menus, this will result in entry to the Main Menu. From sub-menus, it is necessary to carry out this sequence more than once to reach the main menu. CAUTION: If editing a parameter, ensure that the current (highlighted) parameter value is correct before pressing the key as this action will update the instrument to the value displayed.</p>

6 Messages and Error Indications

Start-up Errors

The following displays are shown when an error detected during the power-up self-test.

Option Module Problems

The “**Option Slot n Error**” display is shown when an error detected with the installed option modules - where “n” is the slot number for the fault.

Replace the module in slot “n”. If this does not solve the problem, return the instrument for servicing.

Configuration Problem

Warns if a problem has been detected with the instrument configuration. Check all settings are correct before proceeding. If the problem persists, return the instrument for servicing.

Input Problems

Sensor Break Detection

Whenever a problem is detected with the process variable or auxiliary input connections, their displayed value is replaced with the word “**OPEN**”.

This may be the result of a failed sensor, a broken connection or an input circuit fault. In this condition, the Control Outputs go to the pre-set power value (*see Control Configuration*).

CAUTION:

Correct the signal/wiring problem to continue normal operation.

Un-Calibrated Input Detection

The instrument is fully calibrated during manufacture. If a fault occurs and the calibration data becomes corrupted, the process input display is replaced with the word “**ERROR**”.

In this condition, the Control Outputs go to the pre-set power value (*see Control Configuration*).

CAUTION:

Re-calibrate the input before continuing normal operation. If the problem persists, return the instrument for servicing.

PV Over-range or Under-range Indication

If the measured process variable value is more than 5% above than the Scale Range Upper Limit, its value is replace by the word "**HIGH**".

If the measured process variable value is more than 5% below than the Scale Range Lower Limit, its value is replace by the word "**LOW**".

Auxiliary Input Over-range or Under-range Indication

If the auxiliary input (RSP) is more than 5% above than the Auxiliary Input Upper Limit, its value is replace by the word "**HIGH**".

If the auxiliary input (RSP) is more than 5% below than the Auxiliary Input Lower Limit, its value is replace by the word "**LOW**".

If you need to return your instrument for servicing, check the Service Information screen (available from the main menu) or contact your supplier.

USB Data Transfer Problems

Data Transfer Failure message

If the instrument cannot successfully write to the USB memory stick, the message "**Data Transfer Failure**" will be displayed. Check that there is adequate disk space on the memory stick, then retry.

If the instrument cannot successfully read data from the USB memory stick, the message "**Data Transfer Failure**" will also appear. Check that this operation would not cause the maximum number of profiles and/or segments to be exceeded, then retry.

Getting Help

First Level Support

If the errors persist or other problems are encountered, refer your supplier for first level support. This includes help with configuration, tuning, servicing and replacement modules.

Second Level Support

If your supplier is unable to assist or cannot be contacted, check the Service Information Page (in Configuration Mode) for details of whom to contact.

Third Level Support

If further assistance is required, contact the nearest company from those listed on the back page of this manual.

7 Configuration and Use

Operation Mode

This is the mode used during normal operation of the instrument. It can be accessed from the Main Menu, and is the usual mode entered at power-up. The available displays are dependent upon the features and options fitted and the way in which it has been configured.

WARNING:

DURING NORMAL USE, THE USER MUST NOT REMOVE THE CONTROLLER FROM ITS HOUSING OR HAVE UNRESTRICTED ACCESS TO THE REAR TERMINALS, AS THIS WOULD PROVIDE POTENTIAL CONTACT WITH HAZARDOUS LIVE PARTS.

CAUTION:

Set all Configuration parameters as required before starting normal operations. It is the responsibility of the installing engineer to ensure that the configuration is safe for the intended application.

Base, Trend & Profile Operating Screens

The Base screen is the usual screen displayed during operation. It provides “at a glance” information about the process. The Profile Operating screen shows similar information when using profiles. Trend View is a graphical representation of recent process conditions. Its scale adjusts automatically for the best resolution for the visible data.

Note:

Trend data is not retained at power down or if the Sample Interval is changed.

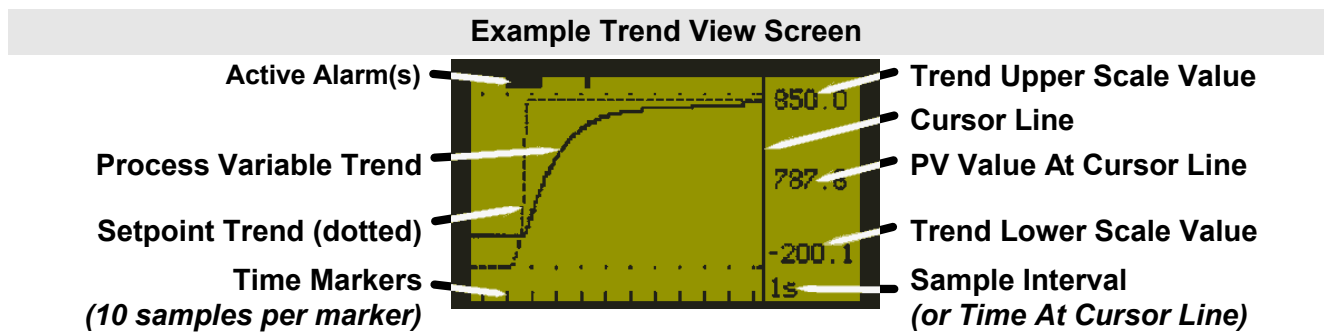
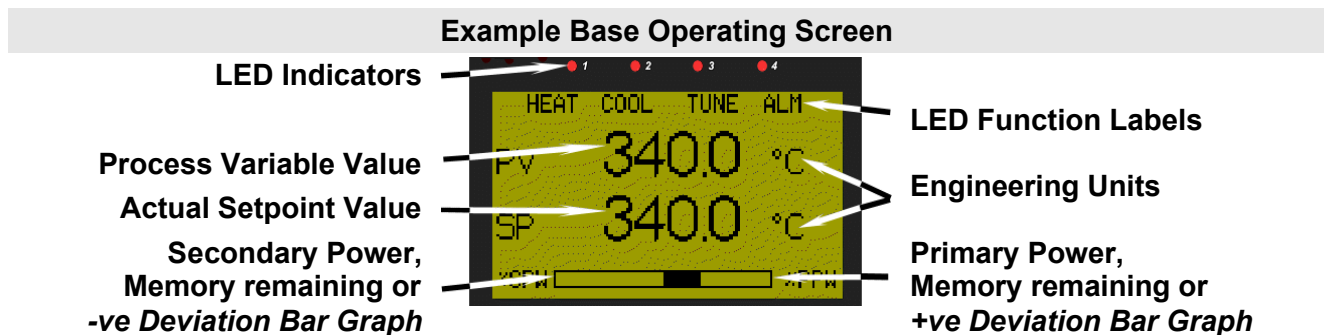

Example Profile Operating Screen

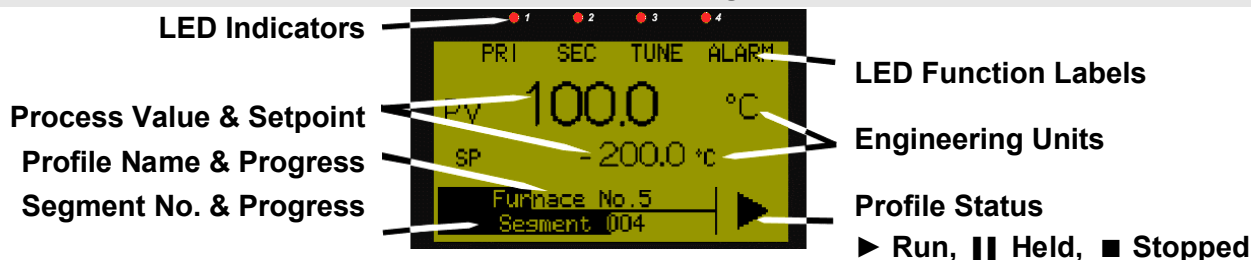



Table 4. Operation Mode Screens



Operation Mode:	
After 2 minutes without key activity, the most screens revert to the Base Operating Screen. Screens marked ⌚ do not revert automatically. They remain displayed until the user navigates away.	
Calibration Check Due Warning	⌚ Shown if a Calibration Reminder is set and the due date has passed - <i>if the feature is enabled in Control Configuration. Recorder version only.</i> Shown at power up (and repeated once per day). Press ■ to acknowledge and continue using the instrument. Re-calibrate or disable the reminder to cancel the warning.
Base Operating Screen. Displayed is: LED Labels; PV value; SP value & Bar Graph	⌚ LED Labels = LED indicator functions. Defaults are HEAT, COOL, TUNE & ALARM - <i>can be altered with configuration software</i> PV value = The current Process Variable value. SP value = The current Setpoint value. Bar Graph = Primary/Secondary Power; Deviation or Memory Use. - <i>see Bar Graph Format screen in Display Configuration.</i>
Auto/Manual Control Mode Selection	Allows switching between automatic and manual control modes. - <i>only shown if enabled in Control Configuration.</i>
Setpoint Value Display & Adjustment	View and alter local (internal) setpoint(s) to any value between the Setpoint Upper and Lower Limits. <i>Remote setpoints are read only.</i>
Setpoint Ramp Rate	Setpoint Ramp Rate adjustment between 0.1 and 9999.0 Display Units per hour. - <i>only shown if enabled in Control Configuration.</i>
Select Setpoint Source	Select if Local Setpoint 1 or the Alternate Setpoint is to be the active setpoint. - <i>only shown if enabled in Control Configuration.</i>
Control Enable	Enables or disables control outputs. When disabled, the unit works normally except the Primary and Secondary Control Outputs are turned off - <i>only shown if enabled in Control Configuration.</i>
Alarm Status	Shows the status (Active, Inactive or Unused) of the five alarms.
Event Status	Shows the status (Active or Inactive) of the five Events - <i>Profiler version only.</i>
Profiler Operating Screen Displayed is: LED Labels; PV value; SP value; Bar Graph & Status Indicator	⌚ LED Labels = LED indicator functions. Defaults are HEAT, COOL, TUNE & ALARM - <i>can be altered with configuration software</i> PV value = The current Process Variable value. SP value = The current Setpoint value. Bar Graph = The Profile Name & overall progress; the current Segment Number and segment progress Status Indicator = ▶ (Run), (Held), or ■ (Stopped). <i>- Profiler version only.</i>

Operator Profile Control		Allows the operator to control the defined profiles. If a profile is running, the choices are: Do Nothing; Abort Profile (end immediately); Jump to Next Segment; Hold Profile or Release Hold. If no profile is running, the choices are: Do Nothing; Run Profile or End Profile Control (returns to standard controller operation). - <i>only shown if enabled in the Profile Control Menu.</i>
Profile Information		Shows the Profile Status (Running, Held, Aborted or Ended); Profile Time Remaining, Cumulative Held Time; Cycles Completed and Profile Sequences Completed - <i>not shown when in Controller mode.</i>
Segment Information		Shows the Current segment number and type (Ramp Up, Ramp Down, Dwell, or End); Segment Time Remaining, Loops completed if loop-back active- <i>not shown when in Controller mode.</i>
Start & Stop Data Recording		Manually Stop or Start a new recording. – <i>only shown if Recorder Log Trigger is Operator Start/Stop.</i>
Recorder Status Information		The status of the data recorder. It shows if a recording is in progress; the recording mode (FIFO or Record Until Memory Is Used); the memory usage for each recording sample; memory remaining (in bytes) and the approximate* recording time remaining. <i>*If the status of alarms is recorded, extra samples are taken when these alarms change state. Therefore recording time will reduce.</i>
Trend View		An auto-scaling trend graph of the Process Variable; Process Variable & Setpoint (dotted line), or the Minimum and Maximum value of the Process Variable measured since the last sample. Any active alarm(s) are indicated above the graph. 120 data points are visible. The user can scroll the right hand cursor line back to examine up to 240 data points. The sample interval is set in Display Configuration.
Recorder Memory Full Warning		Indicates that the Data Recorder memory is full and that recording has stopped – <i>Only if Recording mode is Record Until Memory Full.</i>
- Custom Display Screens		The user can copy up to 50 Configuration Menu parameters into Operation Mode using the PC software. Note: In this mode these screens are <u>not pass-code protected</u> .



Note:

The operator can freely use the screens in this mode, but it is possible to make the entire Operation Mode “read only” from the Display Configuration sub-menu. This includes any custom screens.

Navigating in Operator Mode

Press  to move forward or  to move backwards through the available screens.

When a displayed value can be adjusted, use  or  to change its value.

In Trend View, pressing  or  moves the Cursor Line back through the last 240 data points.

Adjusting the Local Setpoint(s)

Setpoints can be adjusted within the limits set by the Setpoint Upper and Lower Limit parameters in Control Configuration. Operation Mode adjustment of Setpoint is not possible if Read Only Operation Mode has been selected in the Display Configuration settings.

Press  to select the Setpoint Value Display and Adjustment screen

Press  or  to adjust each Local Setpoint to the required value.

A Remote Setpoint value cannot be altered from the key pad.

Adjusting the Setpoint Ramp Rate

The Setpoint Ramp Rate may be adjusted in the range 0.1 to 9999.0 (in display units per hour) and OFF. When the Setpoint Ramp Rate is set to Off, setpoint changes will step immediately to the new value.

Press  to select the Setpoint Ramp Rate screen

Press  or  to adjust ramp rate to the required value.

Note:

The SETPOINT ramp feature disables the pre-tune facility. The self-tune facility will calculate new tuning terms only after the SETPOINT has completed the ramp.

Selecting Automatic or Manual Mode

Depending on the Control Configuration settings, an Auto/Manual selection screen may be shown which allows operators to select between automatic or manual control. Switching to or from manual mode is made via Bumpless Transfer. In Manual mode the Setpoint display is replaced by a 0 to 100% power output level, labelled “**Man**”.

Press  to select the Manual Power screen

Press  or  to adjust required power to the required value.

Note:

In Manual mode a running profile will hold until automatic control is reselected.

CAUTION:

The Manual Mode power level can be adjusted from 0 to 100% (-100 to +100% for dual control). It is not restricted by the Output Power Limit parameters.

Control Enable or Disable

Depending on the Control Configuration settings, a Control Enable/Disable screen may be shown. Disabling control turns off all control outputs (Primary and Secondary power output levels are set to zero).

Press  to select the Control Enable screen

Press  or  to change between control enable and disable.



CAUTION:

Use with care. The instrument is not able to control the process when control is disabled. The Output Power Lower Limit parameters are also ignored.

Main Menu

This menu is used to access the various features and configuration menus available in the instrument. The available menus are dependent upon the features and options fitted and the way in which it has been configured

Entry into the Main Menu

Holding down  and pressing  from Operation Mode and most other screens will cause the unit to enter the Main Menu. Each time this key press sequence is made, the instrument moves to the next menu level above. Sub-menu levels will require this sequence to be pressed more than once in order to reach the Main Menu.

Navigating the Main Menu

Once in the Main Menu, press  or  to select the required option

Press  to enter the chosen menu.

Scrolling “Help Text” is shown at the bottom of the screens to aid navigation.

Unlock Codes









To prevent unauthorised entry, most modes require a pass-code (1 to 9999) to gain entry. These modes are indicated by the symbol  against their names. The default unlock code for all modes is 10 and the current codes can be viewed and changed from the Lock Code View in Configuration Mode. For security, users should to change the codes. If the Configuration Mode lock code is lost, refer to the Lock code View section of this manual.

Table 5. Main Menu Screens

Main Menu:	
Operation Mode	Display of the process and setpoint values, selection/adjustment of the Setpoints, auto/manual control, alarm/event status, trend view and where available, data recorder and profile information.
 Setup Wizard	Easy, step-by-step parameter setup for simple applications.
 Supervisor Mode	If configured from the PC software, a sub-set of up to 50 Configuration screens can be accessed.
 Configuration Menu	Accesses the sub-menus for Input; Control; Outputs; Alarms; Communications; Recorder; Clock; Display; Lock Codes and Reset To Defaults menus and functions.
 Automatic Tuning	Selection of Pre-Tune, Self-Tune and Auto Pre-Tune.
 Profile Setup Menu	Setting of Global Control Parameters for all profiles; plus Profile creation, editing and deletion.
 Profile Control Menu	Selection of profiles. Running, holding or aborting the selected profile.
 USB Menu	Uploading/downloading instrument configuration, profile information and data recordings.
 Recorder Menu	Manually starting, stopping and deleting recordings.
Product Information	Instrument information, including features and options installed.
Service Information	Contact information for service/support etc.

Setup Wizard

An easy Setup Wizard runs automatically at first ever power-up or if whenever a Reset To Defaults is carried out. Users can follow the Wizard screens to setup parameters required for typical applications (*screens marked w in the following Screen Sequence lists are also included in the Setup Wizard*).

A partial Wizard also runs whenever option modules have been changed. The partial wizard, only shows parameters affected by the changes made. The Wizard can also be run manually from the Main Menu. Once completed, the Setup Wizard exits to Operation Mode.

Experts or users with more complex applications can select the parameters they wish to set-up from the Configuration Menus instead of using the Wizard.



Manual entry to the Setup Wizard

CAUTION:

Adjustments to these parameters should only be performed by personnel competent and authorised to do so.

The Setup Wizard can be selected from the Main Menu.

Hold down  and press  from to enter the Main Menu.

Press  or  to select Setup Wizard.

Press  to enter the Setup Wizard.

Note:

With the exception of the first ever power-up, entry into this mode is security-protected by the Setup Wizard Lock Code. Refer to the Lock Code View section for more details.

Navigating in the Setup Wizard

Press  to move forward or  to move backwards through the screens.

Press  or  to change the value as required.

Hold down  and press  to return to the Main Menu

Scrolling “Help Text” is shown at the bottom of the screens to aid navigation.

Table 6. Setup Wizard Screens

🔒 Setup Wizard:		
Setup Wizard Unlocking	w	Enter correct code number to access Setup Wizard.
- major screens from Configuration Menu (those marked w)	w	Press  to select each major configuration parameter in turn. Follow on-screen prompts to alter the values.
Setup Wizard Completed	w	Confirms completion of the Setup Wizard. Exits to Operation Mode.

Supervisor Mode

This mode is only available if it has been configured from the PC software. The software is used to copy up to 50 screens from the Configuration Menus to include in Supervisor Mode. The purpose of Supervisor Mode is to allow certain users access to a lock code protected sub-set of the main configuration parameters without providing them with the higher level Configuration Menu unlock code.

Entry into Supervisor Mode

CAUTION:

Adjustments to these parameters should only be performed by personnel competent and authorised to do so.

Supervisor Mode is entered from the Main Menu

Hold down  and press  from to enter the Main Menu.



Press  or  to select Supervisor Mode

Press  to enter the Supervisor Mode.

Note:

Entry into this mode is security-protected by the Supervisor Mode Lock Code. Refer to the Lock Code View section for more details.

Navigating in Supervisor Mode



Press  to move forward or  to move backwards through the screens.

Press  or  to change the value as required.

Hold down  and press  to return to the Main Menu

Scrolling "Help Text" is shown at the bottom of the screens to aid navigation.

Table 7. Supervisor Mode Screens

 Supervisor Mode:	
Supervisor Mode Unlocking	If Supervisor Mode is configured, enter correct code number to continue.
- Supervisor Mode Screens ...	Press  to select each parameter in turn. Follow on-screen prompts to alter the values.

Configuration Menu

This menu can be used as an alternative to the more limited Setup Wizard when the instrument is configured for the first time, or when further changes are required to the instruments characteristics. Configuration contains a number of sub-menus that allow access to all of the available parameters. The correct settings must be made before attempting to use the instrument in an application. Screens marked **w** are also shown in the Easy Setup Wizard.

Entry into the Configuration Menu

CAUTION:

Adjustments to these parameters should only be performed by personnel competent and authorised to do so.

Configuration is entered from the Main Menu

Hold down  and press  from to enter the Main Menu.

Press  or  to select Configuration Menu

Press  to enter the Configuration Menu.

Note:

Entry into this mode is security-protected by the Configuration Menu Lock Code. Refer to the Unlock Code section for more details.

Navigating the Configuration Menu

Configuration contains sub-menus to set-up the Input; Output; Control; Alarm; Communications; Recorder; Display and Lock Codes. There is also an option to return the instrument to its factory default settings.

The correct settings must be made before attempting to use the instrument in an application.

From the Configuration Menu, press  or  to select the required sub-menu.

Press  to enter the sub-menu.

Scrolling “Help Text” is shown at the bottom of the screens to aid navigation.

Note:

Only parameters that are applicable to the hardware and options fitted will be displayed.

Table 8. Configuration Menu Screens

 Configuration Menu:	
Configuration Mode Unlocking	Enter correct code number to access Configuration Mode.
Configuration Options	Select the required Configuration Sub-Menu Option from: Input; Control; Output; Alarm; Communications; Recorder; Clock; Display; Lock Code or Reset To Defaults.

Input Configuration Sub-Menu

Table 9. Input Configuration Sub-Menu Screens

Input Configuration:		
Process Variable Input Type	w	From various Thermocouple, RTD and Linear inputs. - see <i>specifications section for full details of input types available.</i>
Engineering Units	w	Select display units from: °C; °F; °K; bar; %; %RH; pH; psi or none.
Decimal Point Position	w	Sets the maximum display resolution to 0; 1; 2 or 3 decimal places. Temperature inputs are limited to 0 or 1 place. Numbers >99.999 never display more than 2 dec places, >999.99 never display more than 1 dec place and >99999 always display without a decimal place.
Multi-Point Scaling Enable		Enables or disables Linear Input Multi-Point Scaling. This feature allows up to 15 point linearization of mA or V DC input signals.
Scale Range Lower Limit	w	For Temperature inputs, Upper & Lower Limits set the usable span. Min span = 100 units, max span = range limits - see <i>specs.</i> For Linear inputs, Upper & Lower Limits define the values shown (-1999 to 9999) when input is at minimum and maximum values. Min span = 100 units. If Multi-Point Scaling is enabled, up to 15 breakpoints* can scale input vs. displayed value between the linear input scale limits.
Multi-Point Scale Point(s)		
Scale Range Upper Limit	w	*A breakpoint set at 100% input ends the sequence.
CJC Enable/Disable		Enables/disables internal Thermocouple Cold Junction Compensation. If disabled, external compensation will be required for thermocouples. The default value is Enabled.
Process Variable Offset		Trims the measured process value. +Ve values add to, -Ve values subtract from measured input. Caution: A value other than zero alters the apparent calibration of the instrument. Use with care!
Input Filter Time		Removes unwanted signal noise. Adjustable from 0.0 (OFF) to 100.0 seconds or OFF (default = 2s). Caution: Too large a value will cause slow response to changes in the process. Use with care!
Auxiliary Input <i>n</i> Type	w	Sets the type of signal to be connected to the auxiliary inputs (if fitted). From: 0-10V; 2-10V; 0-5V; 1-5V, 0-20mA or 4-20mA DC. Auxiliary input B also supports >2KΩ Potentiometer and 0-100mV.
Auxiliary Input <i>n</i> Scaling Lower Limit	w	Scales the displayed a value (-9999 to 10000) when an auxiliary input is at or below it's lower limit (e.g. 4mA for a 4-20mA signal).
Auxiliary Input <i>n</i> Scaling Upper Limit	w	Scales the displayed a value (-9999 to 10000) when an auxiliary input is at or above it's lower limit (e.g. 20mA for a 4-20mA signal).
Auxiliary Input <i>n</i> Offset		Trims the displayed a value for auxiliary input A or B. +Ve values are added to, -Ve values subtracted from the measured auxiliary input.
Calibration Reminder Enable/Disable		Enables or disables the display of Calibration Reminder at start-up (repeated daily thereafter), if the due date has passed – Available on the <i>Recorder version only</i>
Calibration Reminder Due Date		Sets the due date for the Calibration Reminder - Available on the <i>Recorder version only</i>

Control Configuration Sub-Menu

Table 10. Control Configuration Sub-Menu Screens

Control Configuration:		
Control Enable/Disable		Sets the method used to enable/disable the control output(s). From: Enabled (<i>always</i>); Disabled (<i>always</i>); Enable/Disable via Digital Input A or B, or Operator Selectable (<i>allows control output(s) to be turned off from Operation Mode</i>). Caution: The instrument is not able to control the process when control is disabled. The Output Power Lower Limit parameters are also ignored. Use with care!
Auto/Manual Mode Access	w	Sets the method used to select Automatic or Manual Control. From: Automatic (<i>always</i>); Manual (<i>always</i>); Select via Digital Input A or B, or Operator Selectable (<i>allows automatic or manual control to be selected from Operation Mode</i>). Caution: In Manual Mode, the user must monitor and alter power to correctly control the process (0 to 100% or -100 to +100% for dual control). Manual power is not restricted by the Output Power Limit parameters. Use with care!
Control Type	w	Set to Single Control for Primary control only (e.g. Heating or Cooling only) or to Dual for Primary and Secondary Control outputs (e.g. Heating & Cooling).
Primary Control Action	w	Set the Primary Control Output for Reverse or Direct Action. Reverse action applies more primary power as the process falls further below setpoint (e.g. heating applications). Direct action applies more primary power as the process rises further above setpoint (e.g. cooling applications). If Dual Control is used, the secondary output action is always opposite to the Primary action.
Control Status		Displays the current Process Variable and Setpoint values to aid manual tuning – <i>This screen is Read Only.</i>
Power Output Level		Displays the current Primary and Secondary control power levels (each 0 to 100%) to aid manual tuning – <i>This screen is Read Only.</i>
Primary Proportional Band		Sets the width of the Primary Proportional Band between 0.5% and 999.9%, or select On-Off control. – <i>This screen is Read Only during automatic tuning.</i>
Secondary Proportional Band		Sets the width of the Secondary Proportional Band between 0.5% and 999.9%, or select On-Off control. – <i>This screen is Read Only during automatic tuning.</i>
Integral Time Constant		Sets the Integral Time Constant (Automatic Reset) from 1s to 99min 59s or OFF. – <i>This screen is Read Only during automatic tuning.</i>
Derivative Time Constant		Derivative Time Constant (Rate) from 1s to 99 min 59s or OFF. – <i>This screen is Read Only during automatic tuning.</i>
Manual Reset (Bias)		Sets the Manual Reset (Proportional Band Bias) from 0-100% or -100 to +100% for Dual Control.
Overlap / Deadband		Sets the Overlap (+ve values) or Deadband (-ve values) between Primary & Secondary Proportional Bands when Dual Control is used.
Primary On-Off Differential		Sets the Primary On-Off control hysteresis (deadband) from 0.1 to 10.0% of Span (centred about setpoint), when Primary On-Off control is used.

Secondary On-Off Differential		Sets the Secondary On-Off control hysteresis (deadband) from 0.1 to 10.0% of Span (centred about setpoint), when Primary PID with Secondary On-Off control is used.
Primary & Secondary On-Off Differential		Sets the combined Primary & Secondary On-Off Control hysteresis (deadband) from 0.1 to 10.0% of Span. when Primary On-Off control and Secondary On-Off control is used.
Primary Cycle Time		Sets the Primary Power Cycle Time (0.5s to 512s). For time proportioned Primary Relay, SSR Driver or Triac Control Outputs.
Secondary Cycle Time		Sets the Secondary Power Cycle Time (0.5s to 512s). For time proportioned Secondary Relay, SSR Driver or Triac Control Outputs.
Primary Power Upper Limit		Sets the Maximum Primary Output Power Limit, from 0 to 100% of available power. This value must be higher than the lower limit. Caution: The instrument will not be able to correctly control the process if sufficient power isn't available to maintain setpoint. Use with care!
Primary Power Lower Limit		Minimum Primary Output Power limit, from 0 to 100%. This value must be less than the upper limit. Caution: The instrument will not be able to correctly control the process if the lower limit is more than required to maintain setpoint. Use with care!
Secondary Power Upper Limit		Maximum Secondary Output Power limit, from 0 to 100%. This value must be higher than the lower limit. Caution: The instrument will not be able to correctly control the process if sufficient power isn't available to maintain setpoint. Use with care!
Secondary Power Lower Limit		Minimum Secondary Output Power limit, from 0 to 100%. This value must be less than the upper limit. Caution: The instrument will not be able to correctly control the process if the lower limit is more than required to maintain setpoint. Use with care!
Sensor Break Pre-set Power Output		Sets the power level applied if the process input (or active RSP) is lost. Adjustable from 0 to 100% or -100 to +100% for Dual Control. The default value is OFF (0% power). Caution: Use a value that will maintain safe conditions.
Setpoint Selection	w	Sets the method to select the Active Setpoint. From: Local Setpoint 1 only; Alternate Setpoint only; Select via Digital Input A or B; or Operator Selectable (allows Setpoint 1 or Alternate Setpoint to be selected from Operation Mode).
Alternate Setpoint Source	w	Up to two setpoints can be used, Local Setpoint 1 plus an Alternate The Alternate Setpoint can be selected from: Local Setpoint 2 or a Remote Setpoint set via Auxiliary Input A or B.
Setpoint Upper Limit		The maximum allowable setpoint value. Adjustable within the Input Span limits, but must be greater than the Setpoint Lower Limit. Applies to both local and remote setpoints. Caution: Operators can adjust the setpoint to any value between the Setpoint Upper and Lower Limits. Use with care!
Setpoint Lower Limit		The minimum allowable setpoint value. Adjustable within the Input Span limits, but must be less than the Setpoint Upper Limit. Applies to both local and remote setpoints. Caution: Operators can adjust the setpoint to any value between the Setpoint Upper and Lower Limits. Use with care!
Setpoint Ramp Editing		Enables or disables the changing of the Setpoint Ramp Rate in Operation Mode – Note: this does not turn off an active ramp. To turn of an active ramp, set the Setpoint Ramp Rate to OFF.

Setpoint Ramp Rate		The Setpoint Ramp Rate value (1 to 9999 display units per hour or OFF). This ramp is applied at power-up and any setpoint changes.
Local Setpoint 1 Value	w	Sets the value of Local Setpoint 1 between the Setpoint Upper and Lower Limits.
Local Setpoint 1 Offset		A value added to the Setpoint 1 value (+ve values) or subtracted from it (-ve values). Use when the instrument is a slave in multi-zone applications to achieve a zone offset. Otherwise, always set to zero.
Local Setpoint 2 Value	w	Sets the value of Local Setpoint 1 between the Setpoint Upper and Lower Limits.
Local Setpoint 2 Offset		A value added to the Setpoint 2 value (+ve values) or subtracted from it (-ve values). Use when the instrument is a slave in multi-zone applications to achieve a zone offset. Otherwise, always set to zero.

Output Configuration Sub-Menu

Table 11. Output Configuration Sub-Menu Screens

Outputs Configuration:		
No Outputs Warning		Shown if the Outputs Configuration menu is entered on an instrument without any output modules fitted.
Linear Output <i>n</i> Type	w	Set the desired type for any Linear Outputs fitted. From: 0-5, 0-10, 1-5, 2-10V & 0-20, 4-20mA or 0-10VDC adjustable Transmitter PSU.
Adjustable 0-10V Transmitter PSU <i>n</i>	w	Sets the voltage required if Linear Output <i>n</i> type is 0-10VDC adjustable Transmitter PSU.
Output <i>n</i> Usage	w	Sets the use for each output fitted. From: Primary or Secondary Control; Alarms; Profile Events & Alarms; Retransmit Process Variable or Setpoint. Choices offered are as appropriate for the output type fitted (e.g. only Linear Outputs can retransmit).
Output <i>n</i> Alarm Selection	w	When an Output Usage is Alarms, this selects which alarm(s) will cause it to change state. From Alarm 1; 2; 3; 4; 5 or a Logical OR of alarms 1 to 2; 1 to 3; 1 to 4 or 1 to 5. Each choice is selectable with Direct Action (on during alarm) or Reverse Action (off during alarm).
Output <i>n</i> Events	w	When an Output Usage is Events & Alarms, this selects which Events(s) will cause it to change state. From: Profile Running or Profile End; Event 1; 2; 3; 4; 5 or a Logical AND of Event <i>n</i> & Alarm <i>n</i> . Each choice is selectable with Direct Action (on during event) or Reverse Action (off during event). - <i>Profiler version only</i>
Retransmit Output <i>n</i> Scale Low	w	Sets the displayed value at which a retransmission output should be at it's minimum level (e.g. the display value when a 4 to 20mA PV Retransmission output will be 4mA. Adjustable from -1999 to 9999.
Retransmit Output <i>n</i> Scale High	w	Sets the displayed value at which a retransmission output will be at it's maximum level (e.g. the display value when a 4 to 20mA PV Retransmission output will be 20mA. Adjustable from -1999 to 9999.

Alarm Configuration Sub-Menu

Table 12. Alarm Configuration Sub-Menu Screens

Alarm Configuration:		
Alarm <i>n</i> Type	w	Sets the type for each of the 5 alarms From: Unused; Process High; Process Low; PV-SP Deviation; Band; Control Loop; Rate Of Signal Change; PV Signal Break; Aux. Input A or B Break.
Alarm <i>n</i> Value	w	Alarm activation point. – applicable if type is High; Low; Deviation (+ve above, -ve below SP), Band (above or below SP) or Rate of Signal Change (a rate of more that <i>x units</i> per hour).
Process Alarm <i>n</i> Hysteresis		Deadband on “safe” side of alarm, through which signal must pass before alarm deactivates.
Signal Change Alarm <i>n</i> Minimum Duration		The minimum time that the rate of input change must be above the alarm threshold for a Rate Of Change Alarm to change state (from on to off, or off to on). Adjustable from 1 to 9999 secs. Caution: If the duration is less than this time, the alarm will not activate no matter how fast the rate of rise.
Alarm <i>n</i> Inhibit		Enables or disables the prevention of initial alarm activation, if the alarm condition is true at power up. Activation only occurs once the alarm condition has passed and then reoccurred.
Loop Alarm Type		Sets the source of the Loop Alarm Time. From: Automatic (2x the Integral Time Constant) or Manual (the Manual Loop Alarm Time value). If configured, a Loop Alarm activates if no response is seen after this time.
Manual Loop Alarm Time		The time allowed after PID power output reaches minimum or maximum), for process to begin responding.

Communications Configuration Sub-Menu

Table 13. Communications Configuration Sub-Menu Screens

Communications Configuration:		
No Communications Warning		If Communications Configuration menu is entered without a communications module fitted.
Modbus RTU Parity	w	From: Odd; Even or None.
Modbus RTU Data Rate	w	From: 9600; 19200; 57600 or 115200 bps.
Master Mode, or Slave Address	w	Slave address (1 to 255), or multi-zone Setpoint Master Mode.
Target Register In Slave		Target register for Setpoint value in attached slave controllers.
Master Mode Format		The data format required by the attached setpoint slaves. From: Integer; integer with 1 decimal place or float.
Serial Communications Write Enable		Enables/disables writing via RS485 or Ethernet (if fitted). When disabled, all parameters are read only.

Recorder Configuration Sub-Menu

Table 14. Data Recorder Configuration Sub-Menu Screens

Recorder Configuration:		
No Recorder Warning		If the Recorder Configuration menu is entered on an instrument without this option fitted.
Recording In Progress Warning		If recording in progress when Recorder Configuration entered. – <i>Allows access to the Recording Start/Stop screen only, until the recording is stopped.</i>
Recorder Mode	w	Choose Record Until Memory Used (Stop recording when full) or Continuous FIFO (First In - First Out) - Caution: A FIFO recording will overwrite all previous recordings in memory, starting with the oldest data first. Download the previous data to USB memory stick before selecting this option.
Recording Sample Interval	w	A recording of the selected data will be taken once every Sample Interval. From: Every 1; 2; 5; 10; 15; 30 Seconds, or Every 1; 2; 5; 10; 15; 30 Minutes. Note: Short intervals will reduce the maximum possible duration of the recording.
Recorder Trigger	w	The recording Start/Stop trigger method to be used. From: Operation Mode selection; Recorder Menu selection; On Alarm(s); Digital Input A or B state; or During Profiles.
Trigger On Alarms		Any from: Alarm <i>n</i> – Where <i>n</i> is alarms 1 to 5. Any combination of these can be set to trigger (TRG) or not (OFF). Any active alarm set to TRG will start the instrument recording. Note: Recording will only stop if all alarms selected as triggers become inactive.
Values To Record		Any from: Process Variable value; Maximum or Minimum PV (since the previous sample was taken); Setpoint; Primary Power or Secondary Power. Any combination of these can be set to Record (REC) or not (OFF). Note: Recording more parameters will reduce the maximum possible duration of the recording.
Alarms & System Events To Record		Any from: Alarm <i>n</i> Status or Unit turned On/Off. Caution: An alarm state change between samples is also recorded. This uses additional recorder memory, which may cause the recording to end sooner than expected.
Profiler Events To Record		Any from: Profiler Event <i>n</i> Status. Caution: A profile event state change between samples is also recorded. This uses additional recorder memory, which may cause the recording to end sooner than expected.
Recorder Status Information		Shows if a recording is in progress; the recording mode; memory usage per sample; memory remaining and the recording time remaining. The time remaining is adjusted for any alarm/events that have already occurred, but cannot allow for any future alarms/events

Clock Configuration Sub-Menu

Table 15. Internal Clock Configuration Sub-Menu Screens

Clock Configuration:		
Date Format	w	Sets the format used for all displayed dates: <i>dd/mm/yyyy (Day / Month / Year)</i> or <i>mm/dd/yyyy (Month / Day / Year)</i> . – Recorder versions only.
Set Date	w	Sets the internal clock Date. – Entered in the format defined by Date Format screen. – Recorder versions only.
Set Day Of Week		Sets the day of week used by the internal clock. – Recorder versions only.
Set Time		Sets the internal clock Time. - In <i>hh:mm:ss (Hours : Minutes : Seconds)</i> format. – Recorder versions only.

Display Configuration Sub-Menu

Table 16. Display Configuration Sub-Menu Screens

Display Configuration:		
Enable Custom Display Mode		Enables/disables Custom Operation Mode, if configured (this mode can only be enabled using the PC configuration software).
Read Only Operation Mode?		Allows Operation Mode to be Read-Only or Read/Write. Screens can be seen but values cannot be changed if set to Read-Only.
Operation Mode Bar Graph Format		From: PID Power; Control Deviation or % Recorder Memory Usage.
Trend Sample Interval		Interval between display of next value on the trend graph From: Every 1; 2; 5; 10; 15; 30 Seconds, or Every 1; 2; 5; 10; 15; 30 Minutes.
Select Trend Mode		From: PV only, PV (solid) & SP (dotted) at sample time or Max/Min PV between samples (candle-stick graph). Alarm activity is shown above the trend graph.
Display Colour		From: Red only; Green only; Red to Green on Alarm or Green to Red on Alarm.
Invert Display		Standard or Negative display image.
Display Contrast		Screen contrast (0 and 100) to improve clarity. 100 = maximum contrast.
Language		Select English or the alternate local language. The alternate language is selected at time of order. The choice of alternate language can be changed using the PC software.



Lock Code View

Unlock Codes

To prevent unauthorised entry, some menus are protected by a lock code. These screens are indicated by the  symbol before their names in the screen list tables. To enter these screens, the correct code must first be entered. The current lock codes can be viewed and changed from the Lock Code View Configuration sub-menu.

The default unlock code for all protected menus is 10. For security, users are recommended to change these codes. A value between 1 and 9999 can be used, or the lock can be set to OFF if no protection is required.

Navigating Lock Code View

Press  to move forward or  to move backwards through the screen elements.

Press  or  to change the value as required.

Hold down  and press  to return to the Main Menu

Scrolling "Help Text" is shown at the bottom of the screens to aid navigation.

Table 17. Lock Code View Sub-Menu Screens



Lock Code View:	
Lock Code View 1	Setup Wizard; Configuration Mode and Tuning Menu Lock Codes (1-9999 or OFF).
Lock Code View 2	Supervisor Mode; USB; Recorder and Profiler Menu Lock Codes (1-9999 or OFF) - if fitted/configured.



Lost Lock Codes



The lock codes can be viewed or changed from Configuration Mode. In the event that the Configuration Mode lock code itself is forgotten, the instrument can be forced into Lock Code View from power-up, where the codes can be checked or set to new values.

Forcing Lock Code View

Power down the instrument.

Re apply the power and hold down  and  for more than 5 seconds as the start-up splash screen appears. Lock Code View will appear.

Press  to move forward or  to move backwards through the screen elements.

Make note of the codes or press  or  to change their values if required.

Hold down  and press  to return to the Main Menu

Scrolling "Help Text" is shown at the bottom of the screens to aid navigation.

Resetting To Defaults

Table 18. Reset To Defaults Sub-Menu Screen

Reset To Defaults:	
Reset To Defaults	Sets all parameters to their factory default values.

If the instrument is to be used in a new or changed application, it is possible to reset all of the instruments parameters back to their factory default settings. The Easy Setup Wizard runs automatically whenever a Reset To Defaults is performed.

CAUTION:

User must reconfigure all required settings before using the instrument in a live application.

Automatic Tuning Menu

The Automatic Tune Menu is used engage the Pre-tune and/or Self-tune facilities to assist the user in setting up Proportional band(s), Integral and Derivative parameter values.

Pre-tune can be used to set PID parameters approximately. Self-tune may then be used to optimise the tuning if required.

Pre-tune can be set to run automatically after every power-up by enabling Auto Pre-Tune.

The **TUNE** indicator (LED 3)* will flash while pre-tune is operating, and is continuously on whilst Self-tune is operating. If both Pre-tune and Self-tune are engaged the **AT** indicator will flash until Pre-tune is finished, and is then continuously on.

Note:

Self-Tune will not engage if either primary or secondary control outputs are set for On-Off control.

Pre-Tune will not engage if either primary or secondary control outputs are set for On-Off control, during setpoint ramping, if a profile is running or if the process variable is less than 5% of the input span from the setpoint.

Navigating Automatic Tuning Menu

Press  to move forward or  to move backwards through the selections.

Press  or  to engage or disengage the tuning as required.

Hold down  and press  to return to the Main Menu

Scrolling "Help Text" is shown at the bottom of the screens to aid navigation.

*Provided the function of LED3 has not been changed (*LED functions can be altered using the PC Configuration Software*).

Table 19. Automatic Tuning Menus Screens

🔒 Automatic Tuning Menu:		
Automatic Tuning Mode Unlocking		Enter correct code number to access the Automatic Tuning Menu.
Pre-Tune	w	Turns Pre-Tune on/off. Pre-Tune is disabled in On-Off Control Mode; if the PV is less than 5% of span from SP; during Profiles or if the Setpoint is Ramping.
Pre-Tune Status		Shows the current Pre-Tune status. Active or Inactive.
Self-Tune		Turns Self-Tune on/off. Self-Tune is disabled in On-Off Control Mode.
Self-Tune Status		Shows current Self-Tune status. Active or Inactive.
Auto Pre-Tune Enable		Enables/Disables Automatic Pre-Tune. When enabled, this attempts to perform a Pre-Tune at every power-up. Normal Pre-Tune engagement rules are applied (see Pre-Tune above).

Profiler Setup Menu

Refer to the Profiler Option section of this manual for more details about the profiler features.

Screens marked ⌚ will not time-out automatically. They must be completed for a valid profile to be created.

Table 20. Profiler Setup Menu Screens

🔒 Profiler Menu:		
General Profile Configuration: <i>Settings that apply to all profiles</i>		
General	Profile Run/Hold Signal	Selects the method used to Run or Hold a profile. From: Digital Input A; Digital Input B or Key Pad Only (using the either the Profile Control Menu or an Operation Mode screen).
	Profile Abort Signal	Selects the method used to force a profile to end prematurely. From: Digital Input A; Digital Input B or Key Pad Only (using either the Profile Control Menu or an Operation Mode screen).
	Control In Operation Mode	Enables/disables the ability to control profiles (run, hold or abort) from Operation Mode.
	Enable Edit While Running	Enables/disables the ability to edit profiles whist a profile is running (even if selected, the current or next segment of the running profile will not change until after the profile is restarted).
Create A Profile	⌚	Creates a new profile. A header is created first, followed by the segments – see below. A warning is displayed if the maximum number of 64 profiles or 255 segments is exceeded.

Profile Header: <i>Settings that apply to the chosen profile as a whole</i>		
Profile Header Details	Enter Profile Name	Up to 16 characters can be used to name each profile
	Profile Starting Point	The setpoint value to be used at the beginning of the first segment. From: Actual Setpoint or Process Variable value at the time the profile starts.
	Profile Start Trigger	From: None (profile start is not delayed); After Delay or Day and Time (Recorder version only).
	Profile Start Time	The time (hh:mm:ss) when the profile should run. – This applies only if Day and Time is the Profile Start Trigger. Caution: Take care not to clash with other profiles. A Profile cannot start if another is running.
	Profile Start Day(s)	The Day(s) when the profile should run. From: Mon; Tue; Wed; Thu; Fri; Sat; Sun; Mon-Fri; Mon-Sat; Sat-Sun or All. – This applies only if Day and Time is the Profile Start Trigger.
	Profile Start Delay	The delay time, up to 99:59 (hh:mm), for a profile to begin after the start request has been given.
	Profile Recovery Method	The power-on action if profile was running at power-down (e.g. after a power cut), or following correction of a signal break. From: Control outputs off; Restart profile from the beginning; Maintain last profile setpoint; Use controller setpoint; Continue profile from where it was when power failed.
	Profile Recovery Time	The Recovery Method is ignored (the profile continues from where power failed), if power off for less than this time. Max 99:59 (hh:mm). - <i>Recorder version only.</i>
	Profile Abort Action	Action after profile has been forced to stop before its end. From: Control outputs off; Maintain last profile setpoint or Use controller setpoint.
	Profile Cycles	The number of times the program should run each time it is started (1-9999 or Infinite).
Profile Segments: <i>Settings that apply to individual profile segments</i>		
Profile Segment Details	Segment Number	Shows the number of the profile segment being created from 1-255
	Segment Type	Set the segment type from: Ramp Time (time to reach target SP); Ramp Rate (rate of change towards target SP); Step (jump to target SP), Dwell (keep current SP); Hold (hold the profile until released); Loop (back to a previous segment); Join (join to another profile); End (end the profile) or Repeat Sequence Then End (repeat a sequence of joined profiles – of which this is the last). A Join, End or Repeat Sequence Then End will become the last segment in the profile.
	Segment Target Setpoint	The setpoint value to be reached by the end of this segment, if the segment type is Ramp Time, Ramp Rate or Step.
	Segment Ramp Time	The time (hh:mm:ss) to reach the Segment Target Setpoint if the segment type is Ramp Time.
	Segment Ramp Rate	The rate of change towards the Segment Target Setpoint if the segment type is Ramp Rate. The rate can be set from 0.001 to 9999.9 display units per hour.
Segment Dwell Time	The time (hh:mm:ss) to maintain the current setpoint if the segment type is Dwell.	

Segment Details (Cont....)	Segment Loop	⌚	Enter the segment to loop back to, and the number of times to loop back, before continuing forward to the next segment, if the segment type is Loop. Note: Two Loops cannot be set to cross each other.
	Segment Auto-Hold Type	⌚	From: None (no auto-hold); Above Setpoint (hold if too high only); Below Setpoint (hold if too low only) or Band (hold if too high or low).
	Segment Auto-Hold Band Value	⌚	The distance from setpoint beyond which the profile is held for the selected Auto-Hold Type. The profile continues once the process returns within this band.
	Segment Hold Release Type	⌚	Sets the method used to release the profile from hold if the segment type is Hold. From: Digital Input A; Digital Input B; Front Keys or Time Of Day. (Time of day on Recorder version only)
	Hold Release Time	⌚	The time of day (hh:mm:ss) when a Hold Segment will release if the Release Type is Time Of Day. Release occurs at the next occurrence of this time.
	Times To Repeat Sequence	⌚	The number of times the entire sequence of profiles should run. – if the last segment is Repeat Sequence Then End.
	Segment End Type	⌚	The action taken after the profile ends normally. From: Control outputs off; Maintain last profile setpoint; Use controller setpoint.
	Select Profile To Join	⌚	Choose a profile to join to from the list provided – if the last segment type is Join. The selected profile will start immediately the current profile ends.
	Segment Events	⌚	Select the event(s) to be active during this segment. For end segments, events selected to be active stay on until the unit exits from profiler mode or a new profile runs.
Edit A Profile Header	⌚	Choose the profile to be edited from the list of names provided, then alter any values as required – <i>The profile header details are as shown in “Create A Profile” above.</i>	
Edit A Profile Segment	⌚	Choose the profile, then the segment to be edited from the lists provided. Alter any values as required – <i>The profile segment details are as shown in “Create A Profile” above.</i> Note: The last segment type can only be set to Join, End or Repeat Sequence Then End.	
Insert A Segment	⌚	Choose the profile, then the new segment’s position from the lists provided – Enter the new segments values as required – <i>The profile segment details are as shown in “Create A Profile” above.</i> Note: The new segments type cannot be set to Join, End or Repeat Sequence Then End.	
Delete A Segment	⌚	Choose the profile, then the segment to be deleted from the lists provided. End, Join or Repeat segments cannot be deleted.	
Delete A Profile	⌚	Choose the profile to be deleted from the list of names is provided. The user is then prompted confirm that it should be deleted.	
Delete All Profiles	⌚	Deletes all profiles from memory. The user is prompted to confirm that all profiles should be deleted. Caution: Use with care!	

Profiler Control Menu



Table 21. Profiler Control Menu Screens

🔒 Profiler Menu:	
Profile Control	<p>If a profile is running, choose from: Do Nothing, Abort Profile (end immediately); or Jump to Next Profile Segment, Hold Profile or Release Hold.</p> <p>If no profile is running, choose from: Do Nothing, Run Profile or End Profile Control (Return to normal controller operation).</p>
Select Active Profile	<p>Change the active profile. Choose from the list of profile names provided. The active profile is the profile that will run, when a run instruction is given (perhaps via a digital input).</p>
Select A Profile To Run	<p>Choose the profile to run from the list of names provided. The profile name and run status is then confirmed.</p>

USB Menu

A Notification is shown if a USB Memory Stick is inserted or removed from the USB Port. The USB Menu will automatically be offered after insertion. The USB menu can also be accessed from the Main Menu. Refer to the USB Interface section for more details on the use of the USB port option.

Table 22. USB Menu Screens

🔒 USB Menu:		
USB Mode Unlocking		Enter correct code number to access USB Menu.
Read/Write To USB Device?		Select the required action from: Read Instrument Configuration (from USB stick); Write Instrument Configuration (to USB stick); Read Profiles (from USB stick); Write Profiles (to USB stick) or Write Recorder Log File (to USB stick).
Write	Select Profile To Write	If writing a profile to the USB Memory Stick, choose a profile to write from the list provided.
	Enter A File or Folder Name	Enter an 8-character folder name for recorder logs, or a file name for configurations or profiles. An extension (bct for configurations, .pfl for profiles) is added to files automatically. Caution: Existing files/folders with the same name will be over-written.
	Writing Profile/Configuration File	An animated screen is shown while the file(s) are being written. Caution: Do not disconnect USB device until completed! Data loss or corruption may result.
	Transfer Successful	Confirmation that the data transfer to the USB stick completed correctly. Press  to continue
	Transfer Failure	For write failures, check for adequate disk space on the USB stick.
Read	Select File	Select the Configuration or Profile file to transfer from the USB stick. Caution: A configuration read overwrites all existing instrument settings.
	Reading Profile/Configuration File	An animated screen is shown while the file is being read. Caution: Do not remove the memory stick whilst this operation is in progress. Data corruption may result.
	Transfer Successful	Confirmation that the data transfer from the USB stick completed correctly. Press  to continue
	Transfer Failure	For read failures, check the maximum number of profiles and/or segments is not being exceeded.

CAUTION:

Do not remove the memory stick from the USB port whilst a Data Transfer to or from the USB stick is in progress. Data loss or corruption may result.

CAUTION:

During Data Transfer, normal operation carries on in the background, but operator access to other screens is not possible. The transfer of a full memory can take up to 7 minutes. Only begin a transfer when you are certain that access (e.g. setpoint changes) will not be required.

Recorder Menu

This menu controls the starting and stopping of the Data Recorder and the deletion of previous recordings. Refer to the Recorder Configuration sub-menu in Configuration Mode for information about how to setup the data to be recorded and the recording interval.

See to the Data Recorder Option section for more details on the use of the recorder and it's features.



Table 23. Recorder Menu Screens

🔒 Recorder Menu:	
Recorder Mode Unlocking	Enter correct code number to access Data Recorder Menu.
Recording In Progress Warning	Shown if a recording is in progress when the Recorder Menu is entered. - <i>Allows access to the Recording Start/Stop screen only, until the recording is stopped.</i>
Start/Stop Data Recording	Manually Stop, or Start a new recording. – if Log Trigger is Recorder Menu Start/Stop.
Abort Recording	Forces a recording to Stop, overriding the selected record trigger. – if Log Trigger is During Alarms; Digital Input A or B; or During Profile.
Recorder Status Information	Shows if a recording is in progress; the recording mode; memory usage per sample; memory remaining and the recording time remaining. The time remaining is adjusted for any alarm or events that have already occurred, but cannot allow for future alarms or events.
Delete Recording	Clears the recorder memory. Caution: Permanently removes All recorded data.

Product Information Mode

This is a read only mode describing the instrument and the options fitted to it.

Navigating Product Information Mode

Press  to move forward or  to move backwards through the displayed information.

Hold down  and press  to return to the Main Menu

Scrolling “Help Text” is shown at the bottom of the screens to aid navigation.

Table 24. Product Information Screens

Product Information Mode:	
Input Calibration Status	Calibration status of the mVDC, VDC, mADC, RTD and Thermocouple CJC inputs. Caution: Re-calibrate the unit if any inputs are not shown as "Calibrated".
Calibration Check Due Date	The date re-calibration is due. – Only shown if the Calibration Reminder is enabled in the Input Configuration menu.
Option Slot <i>n</i> Information	The type of Option Modules (if any) fitted in Option Slot s 1 to 4 and A to C.
Controller Feature Information	Shows the features fitted/enabled in the instrument: Controller Only; USB Port; Data Recorder (includes USB Port) or Profiler.
Firmware Information	The type and version of firmware installed in the instrument.
Serial Number	The instruments serial number.
Date of Manufacture	The instrument's Date of Manufacture

Service Information Mode

This is a read only mode. It provides contact information to the user about where they can obtain service, sales or technical support for the product. Normally this shows either the manufacturer or supplier details. Using the PC software, the user can enter their own details. There are 7 lines of text - each up to 26 characters in length.

Navigating Product Information Mode

There are no other screens in this mode.

Hold down  and press  to return to the Main Menu

Table 25. Service Contact Information Screen

Service Information Mode:	
For Service Contact	Contact information for Service, Sales or Technical Support.

8 The USB Interface

The features covered in this section of the manual are available on models fitted with the optional USB Interface or the Data Recorder (which includes the USB Interface).

Using the USB Port

The USB Interface option allows the user to upload or download instrument settings to or from a USB memory stick. This allows easy configuration of multiple instruments by copying from one to another, or to transfer it to or from the PC configuration software. If the Data Recorder or Profiler options are fitted, recordings and profile information can also be transferred via USB memory stick. Refer to the USB Menu section for more details.

USB Memory Stick Folders & Files

When a USB stick is inserted, the instrument looks for, and if necessary creates the **DEVICE**, **CONFIG**, **PROFILE** and **RECORDER** folders. Files must be located in these folders in order to be used. When preparing to upload files from your PC, ensure that you save them to the correct folder on the memory stick.

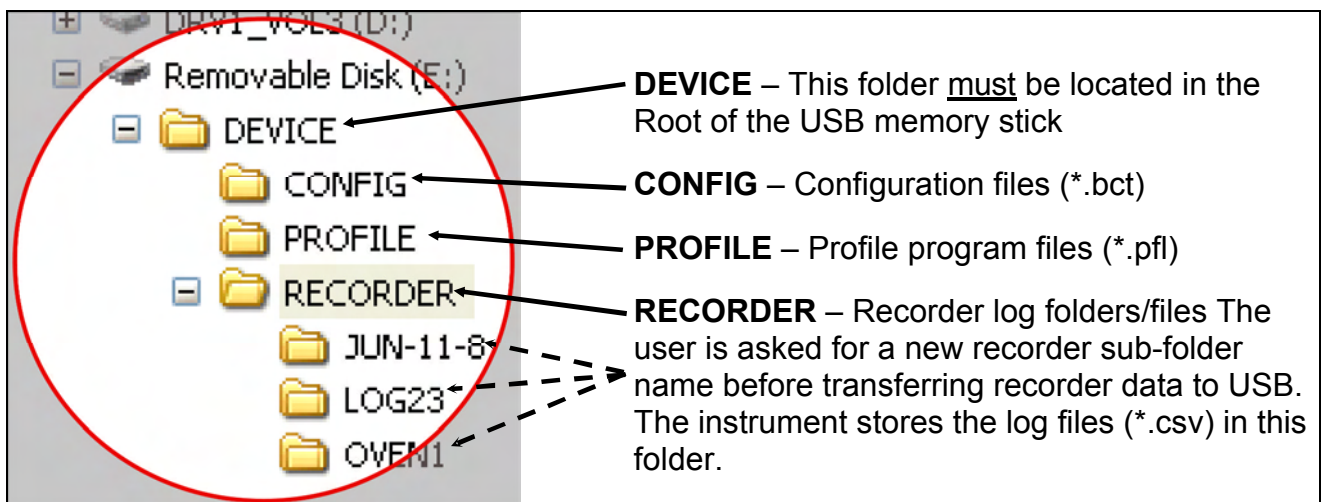

CAUTION:

If the file or folder named already exists, data will be overwritten

The first recorder log file written is named 000001-1.csv and placed in the new Recorder sub-folder. Stopping/starting a recording does not create a new file, but each time the parameters being recorded are changed a new file is created (e.g. 000002-1.csv then 000003-1.csv etc). If any of these files would exceed the maximum spreadsheet size of 65500 data lines, a new file is created with the last digit incremented by 1 (e.g. 000001-2.csv then 000001-3.csv).

Note:

To speed up the disk operation, keep the number of files in these folders to a minimum.

CAUTION:

Do not remove the memory stick from the USB port whilst a data transfer operation is in progress. Data loss or corruption may result.

9 The Data Recorder Option

The features covered in this section are available on models fitted with the Data Recorder option. This option includes a USB Interface (*refer to section 8*) and a Real Time Clock (RTC) with battery backup..

Introduction

The Data Recorder option allows the user to make a recording of the process over time. Recordings can be transferred to a memory stick using the USB Port.

Recordings are stored in Comma Separated format (.csv), suitable for use with spreadsheets, or for import in to other software. See the USB Memory Stick Folders & Files details (in section 8) for file information.

A Recorder Configuration sub-menu is added to the Configuration Menu and Recorder Control can be optionally added to the Main Menu or Operation Mode. The RTC also expands the profiling capabilities (refer to section 10) and allows a "calibration due" reminder to be shown at a date specified by the user.

Changes To Operation Mode

The Data Recorder adds the option for a Calibration Reminder and a % memory use bar graph to the Operation Mode screen sequence.

Calibration Reminder

A "calibration due reminder" can be shown if the date is equal to or after the Calibration Reminder Date. The reminder screen persists until the  key is pressed. If due, the reminder is shown at Power-up, and repeated every 24hrs until the reminder date is changed. The Calibration Reminder enable/disable and Reminder Date parameters can be set from the Input Configuration Menu.

Memory Use Bar Graph

The bar-graph shown in the main Operation Mode screen can be set to show 0 to 100% of recorder memory used instead of the standard options of PID power or control deviation. The Bar Graph Format is defined in the Display Configuration Menu.

10 The Profiler

The features covered in this section relate to the Profiler (Setpoint Programmer) option. If the instrument also has the Data Recorder option fitted, it's Real Time Clock is used to expand the profiling capabilities by adding Day & Time profile start options, releasing of hold segments at a specific time of day and changing the power fail recovery option to one based on the length of time the power has been off. These features are explained below and in the Profiler Setup and Profile Control menus (refer to section 7)

Introduction

The Profiler allows the user to store up to 255 profile segments, shared between a maximum of 64 Profiles. Each profile controls the value of the setpoint over time; increasing, decreasing or holding its value as required. If fitted, Profiler options are shown to the Main Menu as well as the Operation Mode.

Profile Components

The General Profile Configuration settings decide how profiles can be Run, Held or Aborted. These settings apply to all profiles. Each profile has its own header information, plus 1 or more segments.

Profile Header & Segment Information

The profile header contains information about how the profile starts and stops, the power loss recovery action and how many times it should be repeated.

Note:

Profile Header information is stored to memory as the Segment creation sequence begins. No profile is created if you exit before this point.

Segments can be ramps, dwells, steps or special segments such as holds, ends or joins. Note: Segment information is stored as each segment is created, but the profile remains invalid until an end or join segment is defined.

Profile Starting & Standard Segments

The example profiles below contain examples of the standard segment types required to make simple profiles or profile sequences. A **Start Trigger** is the instruction to begin the selected profile. Depending on the Run/Hold Signal parameter setting in the Profile Setup Menu, this can be from a Key-press given in the appropriate screen, a digital input signal or via a serial communications command.

Following a Start Trigger, profiles can start immediately, after a delay, or from the Timer (*Timer start available on Recorder version only*).

CAUTION:

A timer start time should not clash with other profiles. A profile will not start if another is running. Remember that delays caused by manual holds or Auto-Hold can effect when the previous running profile will finish.

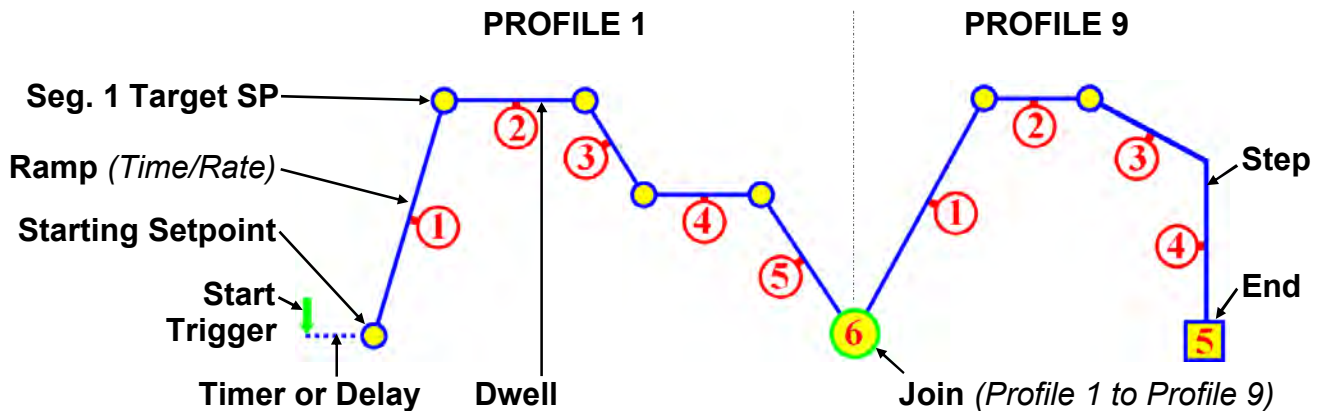

Figure 38. Profile Starting and Standard Segment Types

Ramps, Dwells and Step Segments each have an end of segment Target Setpoint. If a segment is a **Ramp-Time** type, the slope needed to reach the target in the defined time will change depending on the Starting Setpoint value. For a **Ramp-Rate** segment, the slope is defined by the segments Ramp Rate, so the time to reach the target setpoint will change instead. This is of particular significance for the first segment, since the starting value of the process may not be known.

A **Dwell** (sometimes called a soak) holds the last segment's value for the specified Dwell Time.

Step segments jump straight to the new target setpoint value.

An **End** segment ends the profile sequence.

If the last segment is a **Join**, the join target profile will start.

Note:

The Profile sequence will abort if the join target has been deleted.

Loops Segments

A **Loop Segment** goes back to a specified segment in the current profile. This action is repeated for the required number of times (1 to 9999) before the profile continues onwards. More than one Loop Segment can be used in a profile, but they must not cross.

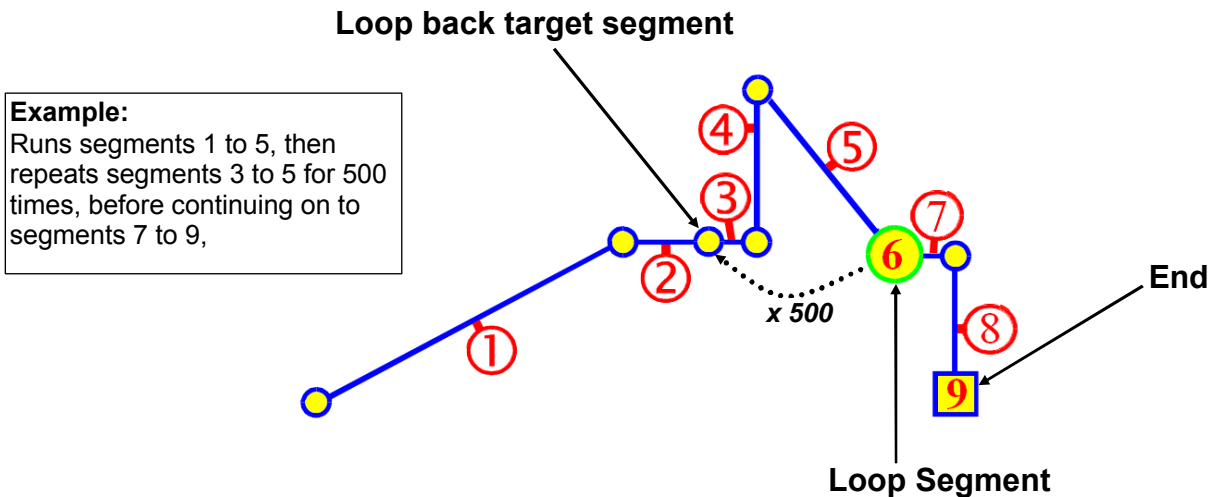

Figure 39. Loops Segments

Profile Running / Holding vs. Hold Segments

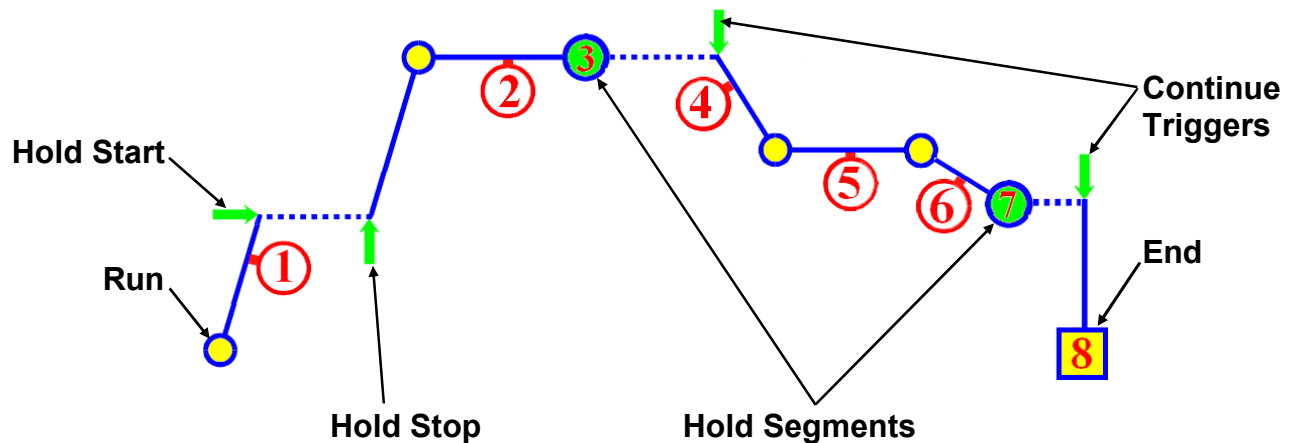

Figure 40. Run/Hold & Hold Segments

A **Hold** during a segment maintains the current setpoint value. Once the hold condition is stopped the Ramp or Dwell continues. Depending on the configuration, a hold can be the started & stopped by via a key-press, breaking the signal to a Run/Hold digital input, a serial comms command or by the Auto-Hold feature (see below).

Note:

A running profile will also hold while Manual Control is selected.

A **Hold Segment** is a pre-planned hold, programmed into the profile. It maintains the value of the previous segment. The profile does not continue until a **Continue Trigger** occurs. This can be via a key-press, a digital input signal or after waiting for a time of day (*available on Recorder version only*).

The Auto-Hold Feature

Each profile segment has individual Auto-Hold settings. If utilised, these ensure that the profile and the actual process remain synchronised. If the process does not closely match the required setpoint by remaining within the defined **Hold Band**, the profile can be held until it returns within bounds.

The user can choose to hold the profile if the process goes beyond the Hold Band **Above The Setpoint** only, **Below The Setpoint** only or to **Band** (either side of the setpoint). When Auto-Hold becomes active, the profile status is shown as "Held".

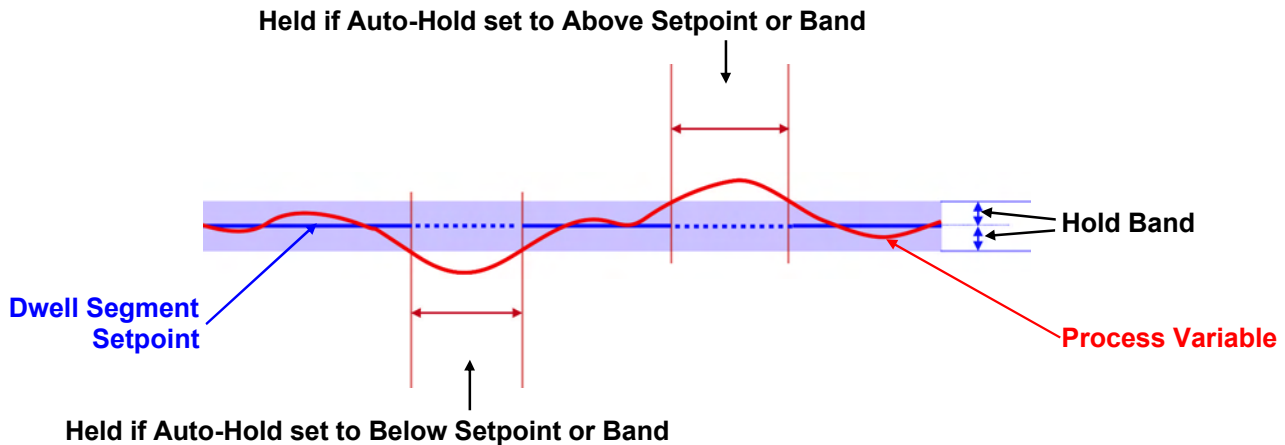

Figure 41. Auto-Hold On A Dwell Segment

During a Dwell, the dwell time is increase by the time that the process is outside of the hold band in the selected direction(s). This ensures the process was at the desired level for the required amount of time.

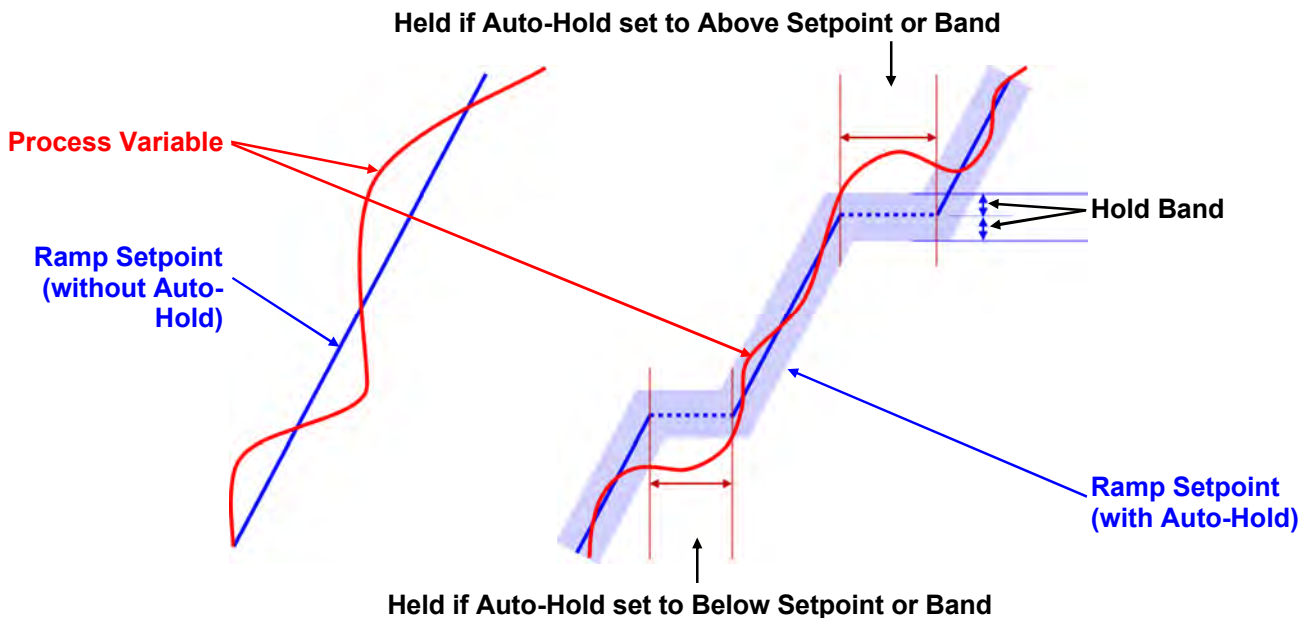

Figure 42. Auto-Hold On A Ramp Segment

During a Ramp segment, the ramp is held at the current setpoint value while the process is outside of the hold band in the selected direction(s). The time taken to complete the ramp is increased by the time taken by the Auto-Hold.

Profile Cycles & Repeat Sequences

A profile can be configured to run itself 1 to 9999 times or continuously using the Profile Cycles setting. A profile ending with **Repeat Then End** will run the entire sequence of profiles again from 1 to 9999 times before ending.

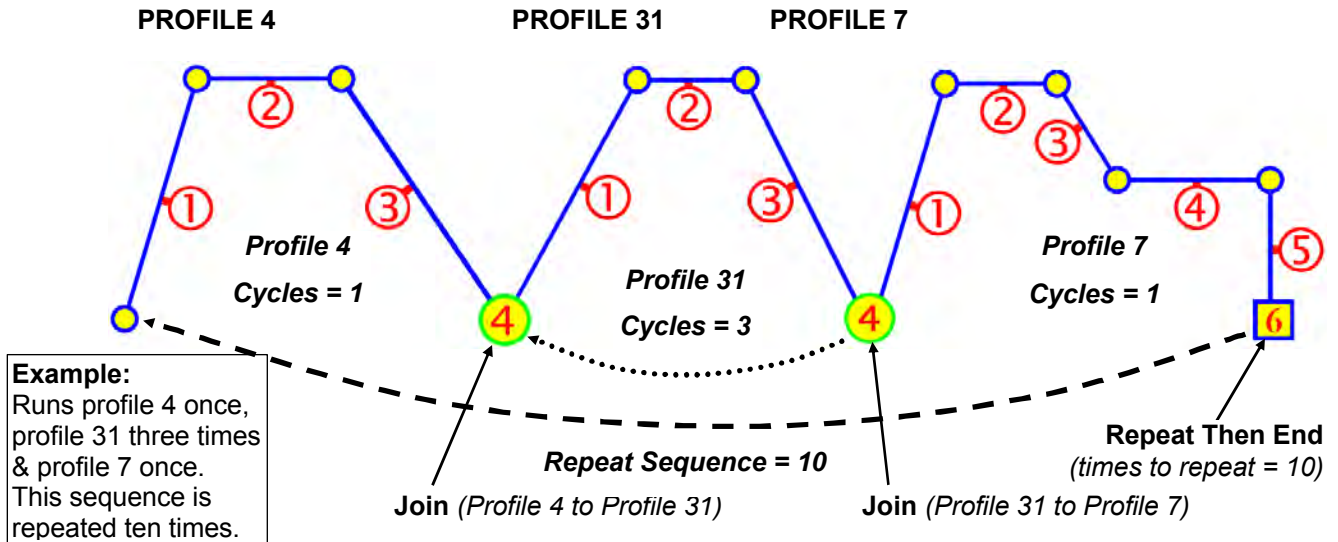

Figure 43. Profile Cycles & Repeats

Power/Signal Lost Recovery Actions

If there is a power cut while a profile is running, the instrument will use the defined **Profile Recovery Method** once the power has been restored.

If there is a break in the input while a program is running, the unit will go to the Pre-Set Power Value during the break condition. Once the condition has ended it carries out the same recovery action as specified for power failure.

Note:

Recorder versions always use option E (Continue profile from the point it had reached when the power failed) if the Power Off Time is less than the Profile Recovery Time setting. If the power is off for more than this time, the defined Profile Recovery Method is used.

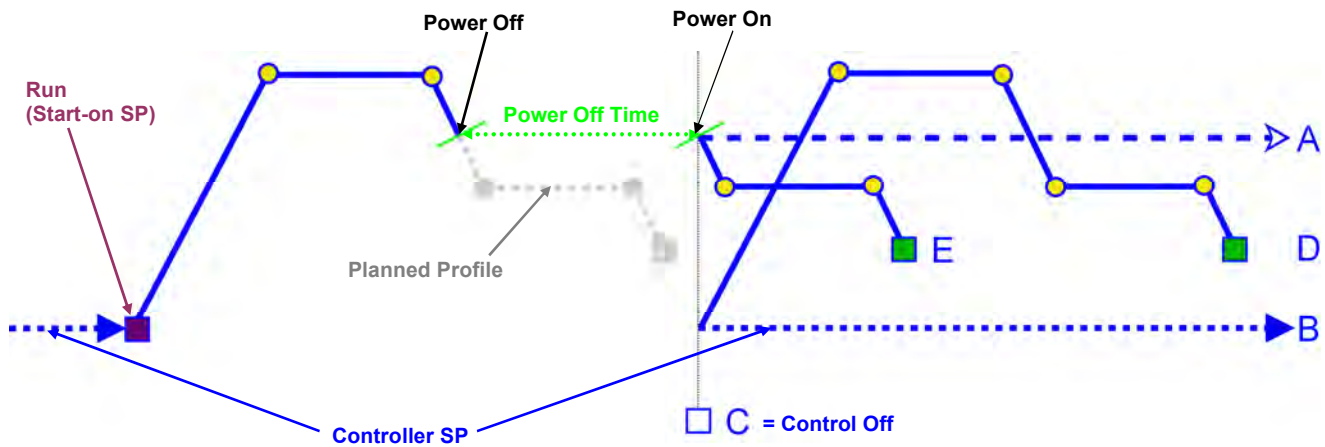

Possible Recovery Methods:

- A Abort the profile and maintain the profile value from the time the power failed.
- B Abort the profile and use Controller Setpoint value.
- C Abort the profile with the Control outputs off.
- D Restart the profile again from the beginning.
- E Continue profile from the point it had reached when the power failed

Figure 44. End, Abort and Recovery Actions

Profile End Actions

Once a running profile ends, that profiles' **Segment End Type** defines action taken by the instrument. If a sequence of profiles has been completed, the End Segment Type of the last profile will be carried out. The possible end actions are explained below.

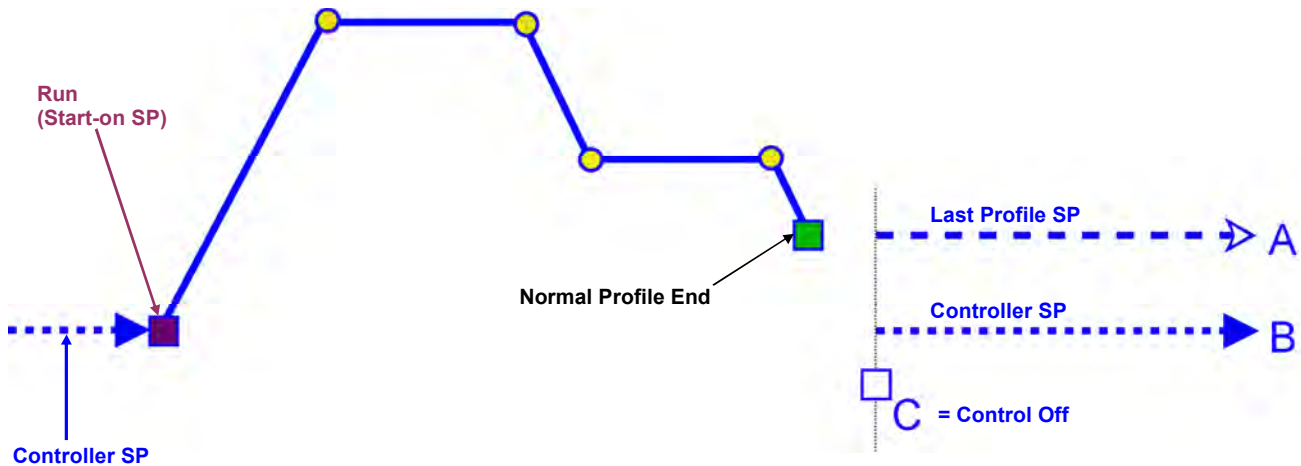

Possible Profile End Actions:

- A At profile end, maintain the Final Setpoint value of the last segment.
- B At profile end, exit Profiler Mode and use the Controller Setpoint value.
- C At profile end, remain in Profiler Mode with the Control outputs off.

Figure 45. Profile End Action

Profile Abort Actions

If a running profile is forced to end early, the **Profile Abort Action** defines action taken by the instrument. This is set in the General Profile Configuration section of the Profile Setup Menu, and is common to all profiles.

The possible options are explained below.

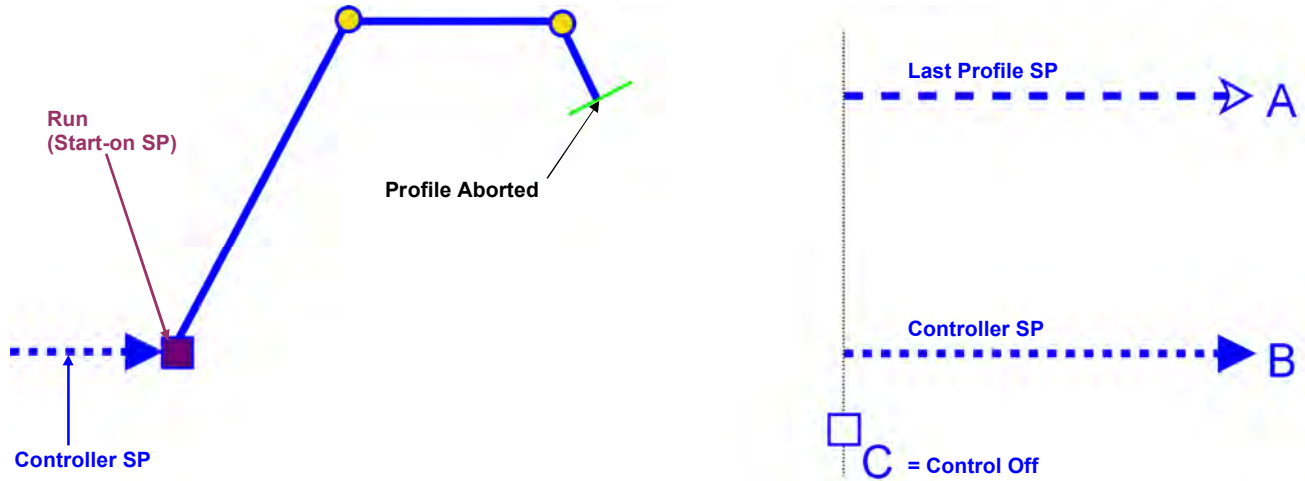

Possible Profile Abort Actions:

- A** Abort the profile and maintain the value of the setpoint at the time of the abort.
- B** Abort the profile and exit Profiler Mode using the Controller Setpoint value.
- C** Abort the profile and remain in Profiler Mode with the Control outputs off.

Figure 46. Profile Abort Action

11 Manually Tuning Controllers

Single Control Tuning (PID with Primary Output only)

This technique balances the need to reach setpoint quickly, with the wish to limit setpoint overshoot at start-up or during process changes. It determines values for the Primary Proportional Band and the Integral and Derivative time constants that allow the PID control algorithm to give acceptable results in most applications that use a single control device.

CAUTION:

This technique is suitable only for processes that are not harmed by large fluctuations in the process variable.

1. Check that the Setpoint Upper Limit and Setpoint Lower Limit are set to safe levels for your process. Adjust if required.
2. Set the Setpoint to the normal operating value for the process (or to a lower value if overshoots beyond this value might cause damage).
3. Select On-Off control (i.e. set the Primary Proportional Band to zero).
4. Switch on the process. The process variable will oscillate about the setpoint. Record the Peak-to-Peak variation (**P**) of the first cycle (i.e. the difference between the highest value of the first overshoot and the lowest value of the first undershoot), and the time period of the oscillation (**T**) in minutes. See the example diagram below - Manually Tuning PID.
5. Calculate the PID control parameters using the formula below. **P.Pb** is the Primary Proportional Band, **Int.T** is the Integral Time Constant, and **Der.T** is the Derivative Time Constant. The Input Span is the difference between Scale Range Lower Limit and Scale Range Upper Limit:

$$\begin{aligned}
 \mathbf{P.Pb} &= \frac{\mathbf{P}}{\mathbf{Input\ Span}} \times 100 \\
 \mathbf{Int.T} &= \mathbf{T} \text{ minutes} \\
 \mathbf{Der.T} &= \frac{\mathbf{T}}{6} \text{ minutes}
 \end{aligned}$$

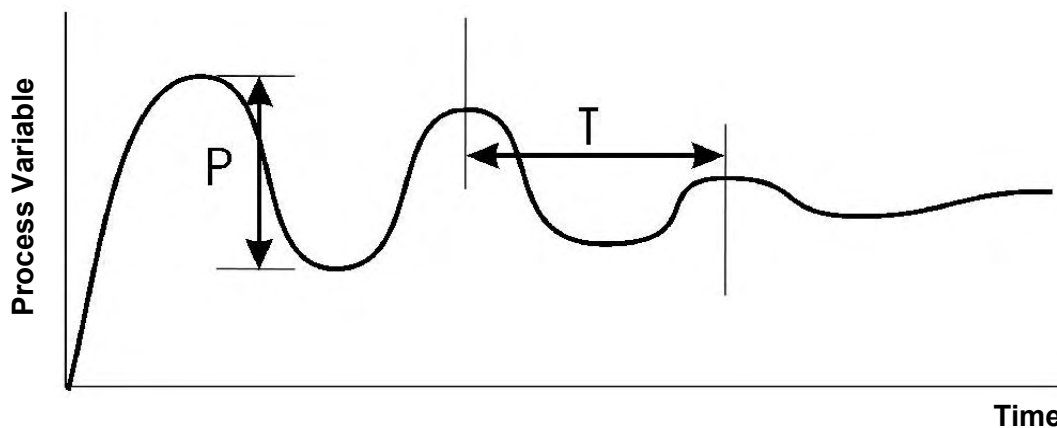

Figure 47. Manually Tuning PID

Dual Control Tuning (PID with Primary and Secondary Outputs)

This tuning technique balances the need to reach setpoint quickly, with the wish to limit setpoint overshoot at start-up and during process changes. It determines values for the Primary Proportional Band, Secondary Proportional Band, Integral and Derivative time constants that allow the PID control algorithm to give acceptable results in most applications that use dual control (e.g. Heat & Cool).

CAUTION:

This technique is suitable only for processes that are not harmed by large fluctuations in the process variable.

1. Tune the controller using only the Primary Control output as described in the Single Control Tuning section above.
2. Set the Secondary Proportional Band to the same value as the Primary Proportional Band and monitor the operation of the controller in dual control mode. If there is a tendency to oscillate as the control passes into the Secondary Proportional Band, increase its value. If the process appears to be over-damped (slow to respond) in the region of the Secondary Proportional Band, decrease its value.
3. When the PID tuning values have been determined, if there is a disturbance to the process variable as control passes from one proportional band to the other, set the Overlap/Deadband parameter to a positive value to introduce some overlap. Adjust this value by trial and error until satisfactory results are obtained.

PI Tuning (Valve, Damper & Speed Controllers)

This tuning technique is used when controlling a damper, a modulating valve or motor speed controller. It determines values for the Primary Proportional Band, and Integral Time Constant. The Derivative Time Constant is normally set to OFF. This type of control (known as PI Control) minimises valve/motor wear whilst giving optimal process control.

CAUTION:

This technique is suitable only for processes that are not harmed by large fluctuations in the process variable.

1. Set the setpoint to the normal operating process value (or to a lower value if overshoot beyond this value is likely to cause damage).
2. Set controller to On/Off Control mode (i.e. set Primary Proportional Band to the minimum value).
3. Set the Integral Time Constant to OFF.
4. Set the Derivative Time Constant to OFF.

5. Follow the instructions in the diagram below. At each stage, allow sufficient settling time before moving on to the next stage. **P.Pb** is the Primary Proportional Band, **Int.T** is the Integral Time Constant.

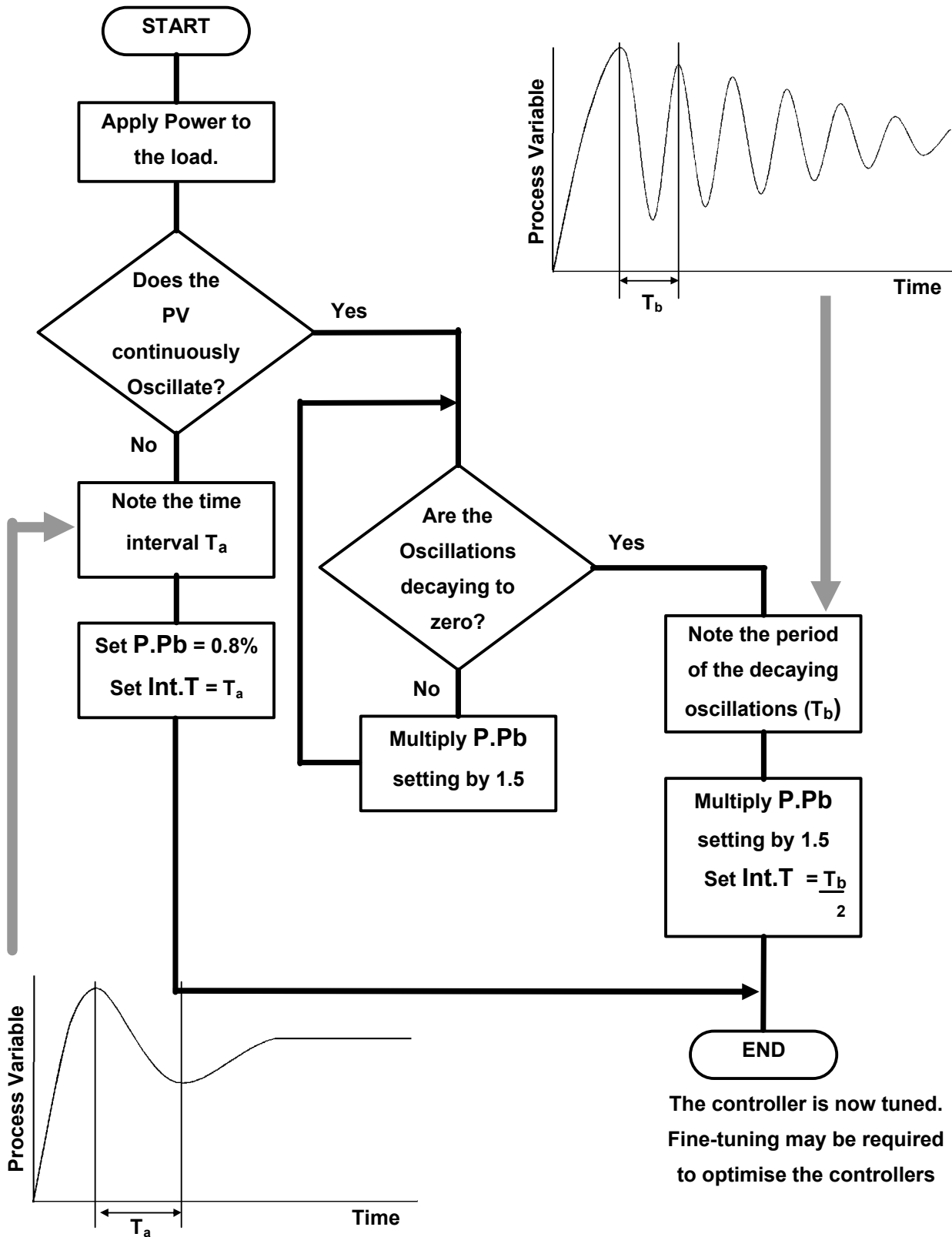

Table 26. Manually Tuning Valve Control

Fine Tuning.

A separate cycle time adjustment parameter is provided for the Primary and Secondary control when using time proportioning control outputs.

Note:

Adjusting the cycle time affects the controllers operation; a shorter cycle time gives control that is more accurate, but mechanical components such as relays will have a reduced life span.

1. Increase the width of the proportional band if the process overshoots or oscillates excessively.
2. Decrease the width of the proportional band if the process responds slowly or fails to reach setpoint.
3. To find the optimum value for the Integral Time, decrease its value until the process becomes unstable, then increase it a little at a time, until stability has is restored. Induce a load disturbance or make a setpoint change to verify that the process stabilises. If not increase the value some more and re-test.

Note:

Allow enough time for the controller and process to adjust between changes.

4. Initially add Derivative at a value between $1/4^{\text{th}}$ and $1/10^{\text{th}}$ of the Integral Time value.
5. Increase the Derivative Time if the process overshoots/undershoots, increase its value a little at a time, if the process becomes unstable, until the oscillation stops. Induce a load disturbance or make a setpoint change to verify that the process stabilises. If not decrease the value some more and re-test.

Note:

When controlling a modulating valve, it is recommended that Derivative is set to OFF to avoid excessive valve activity. Derivative can cause process instability in these processes.

6. After making all other adjustments, if an offset exists between the setpoint and the process variable use the Bias (manual reset) to eliminate the error:

Below setpoint - use a larger value
Above setpoint - use a smaller value.

12 Serial Communications

Supported Protocols

Communication with a Modbus RTU or Modbus TCP master device is possible if the appropriate communications module is fitted into Option Slot A. An RS485 Module is required for Modbus RTU. An Ethernet Module is required for Modbus TCP.

The instrument can also act as Setpoint Master over RS485 in multi-zone applications. In this mode the unit continuously sends its setpoint value using Modbus broadcast messages.

For a complete description of the Modbus protocol refer to the description provided at <http://www.modbus.org/>

All models also have a configuration socket for use with the PC configuration software. An RS232 to TTL lead (*available from your supplier*) is required in order to use this socket. A front mounted USB port is available on some models; this can also be used to configure the instrument or to transfer recorder or profile files via a USB memory stick.

RS485 Configuration

The RS485 address, bit rate and character format are configured via the front panel from the Comms Configuration menu or by using the PC Configurator software.

Physical layer configuration settings possible are:

Data rate: 4800, 9600, 19200, 38400, 57600 or 115200 bps

Parity: None (default), Even, Odd

Character format: Always 8 bits per character.

Device Address: *See below.*

RS485 Device Addressing

The instrument must be assigned a unique device address in the range 1 to 255. This address is used to recognise Modbus Queries intended for this instrument. With the exception of globally addressed broadcast messages, the instrument ignores Modbus Queries that do not match the address that has been assigned to it.

The instrument will accept broadcast messages (global queries) using device address 0 no matter what device address is assigned. No response messages are returned for globally addressed Queries.

Ethernet Configuration

For Modbus TCP communications (Modbus over Ethernet), the IP address can either be assigned by a Dynamic Host Configuration Protocol (DHCP), BootP or AutoIP server on the network, or manually assigned using the IP address allocation software tool.

Refer to the PC Software section of this manual for more information setting IP addresses. The supported data rates 10/100BASE-T (10 or 100 Mbps) are automatically detected.

Link Layer

A Query (or command) is transmitted from the Modbus Master to the Modbus Slave. The slave instrument assembles the reply to the master. All of the instruments covered by this manual are slave devices, and cannot act as a Modbus Master.

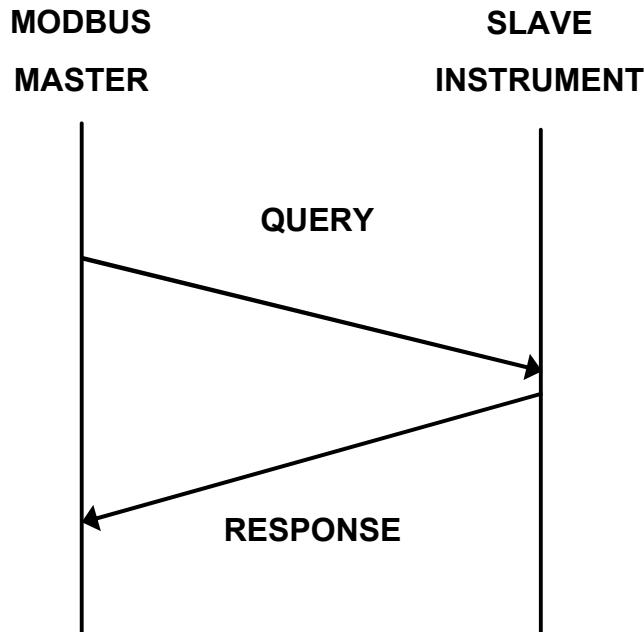

Figure 48. Modbus Link Layer

A message for either a QUERY or RESPONSE is made up of an inter-message gap followed by a sequence of data characters. The inter-message gap is at least 3.5 data character times - the transmitter must not start transmission until 3 character times have elapsed since reception of the last character in a message, and must release the transmission line within 3 character times of the last character in a message.

Note:

Three character times is approximately 0.25ms at 115200 bps, 0.51ms at 57600 bps, 0.75ms at 38400 bps, 1.5ms at 19200 bps, 3ms at 9600 bps and 6ms at 4800bps.

Data is encoded for each character as binary data, transmitted LSB first.

For a QUERY the address field contains the address of the slave destination. The slave address is given together with the Function and Data fields by the Application layer. The CRC is generated from the given address, function and data characters.

For a RESPONSE the address field contains the address of the responding slave. The Function and Data fields are generated by the slave application. The CRC is generated from the address, function and data characters.

The standard MODBUS RTU CRC-16 calculation employing the polynomial $2^{16}+2^{15}+2^2+1$ is used.

Inter-message gap	Address 1 character	Function 1 character	Data <i>n</i> characters	CRC Check 2 characters
-------------------	------------------------	-------------------------	-----------------------------	---------------------------

Supported Modbus Functions

Modbus defines several function types. The following types are supported by this instrument:

Function Code (decimal)	Modbus Meaning	Description
03 / 04	Read Holding/Input registers	Read current binary value of specified number of parameters at given address. Up to 64 parameters can be accessed with one Query.
06	Write Single Register	Writes two bytes to a specified word address.
08	Diagnostics	Used for loopback test only.
16 (0x10 hex)	Write Multiple Registers	Writes up to 253 bytes of data to the specified address range.
23 (0x17 hex)	Read/Write Multiple Registers	Reads and Writes 253 bytes of data to the specified address ranges.

Function Descriptions

The following is interpreted from the Modbus Protocol Description obtainable from <http://www.modbus.org/>. Refer to that document if clarification is required.

In the function descriptions below, the preceding device address value is assumed, as is the correctly formed two-byte CRC value at the end of the QUERY and RESPONSE frames.

Function 03 / 04 - Read Holding/Input Registers

Reads current binary value of data at the specified word addresses.

QUERY

Function	Address of 1 st Word		Number of Words	
03 / 04	HI	LO	HI	LO

RESPONSE

Function	Number of Bytes	First Word		Last Word	
03 / 04		HI	LO	HI	LO

In the response the “Number of Bytes” indicates the number of data bytes read from the instrument. E.g. if 5 words are read, the count will be 10 (A hex). The maximum number of words that can be read is 64. If a parameter does not exist at one of the addresses read, then a value of 0000h is returned for that word.

Function 06 - Write Single Register

Writes two bytes to a specified word address.

QUERY

Function	Address of Word		Value to write	
06	HI	LO	HI	LO

RESPONSE

Function	Address of Word		Value written	
06	HI	LO	HI	LO

Note:

The Response normally returns the same data as the Query.

Function 08 - Loopback Diagnostic Test

QUERY

Function	Diagnostic Code		Value	
08	HI =00	LO=00	HI	LO

RESPONSE

Function	Sub-function		Value	
08	HI=00	LO=00	HI	LO

Note:

The Response normally returns the same data as the loopback Query. Other Diagnostic Codes are not supported.

Function 16 - Write Multiple Registers (0x10 Hex)

Writes consecutive word (two-byte) values starting at the specified address.

QUERY

Function	1 st Write Address		Number of Words to Write		Number of Query Bytes	1 st Query Byte	2 nd Query Byte	etc	Last Query Byte
10	HI	LO	HI	LO				→	

RESPONSE

Function	1 st Word Address		Number of Words	
10	HI	LO	HI	LO

Note:

The number of data bytes that can be written in one message is 253 bytes.

Function 23 Hex - Read / Write Multiple Registers (0x17 hex)

Reads and writes the requested number of consecutive words (two-bytes) starting at the specified addresses.

QUERY

Function	1 st Read Address		Number of Words to Read		1 st Write Address		Number of Words to Write		Values to Write						
	HI	LO	HI	LO	HI	LO	HI	LO	1 st Word	2 nd Word	etc	Last Word			
17	HI	LO	HI	LO	HI	LO	HI	LO	HI	LO	HI	LO	→	HI	LO

RESPONSE

Function	Number of Bytes	Read Data						
		1 st Word		2 nd Word		etc	Last Word	
17		HI	LO	HI	LO	→	HI	LO

Note:

The number of data bytes that can be read and written in one message is 253 bytes.

Exception Responses

When a QUERY is sent that the instrument cannot interpret, an Exception RESPONSE is returned. Possible exception responses are:

Exception Code	Error Condition	Interpretation
00	Unused	None.
01	Illegal function	Function number out of range.
02	Illegal Data Address	Write functions: Parameter number out of range or not supported. (for write functions only). Read Functions: Start parameter does not exist or end parameter greater than 65536.
03	Illegal Data Value	Attempt to write invalid data / required action not executed.

The format of an exception response is:

RESPONSE

Function	Exception Code
Original Function code with its Most Significant Bit (MSB) set.	<i>as detailed above</i>

Note:

In the case of multiple exception codes for a single QUERY the Exception code returned is the one corresponding to the first parameter in error.

13 Modbus Parameters

The Modbus parameter register addresses are detailed in the tables below. The Access column indicates if a parameter is read only (RO) or if it can also be written to (R/W). Communications writes will not be implemented if the Writing Via Serial Comms parameter in the Communications Configuration menu is set to Disabled.

Note:

Some parameters that do not apply for a particular configuration will accept reads and writes (e.g. attempting to scale a Linear output which has not been fitted). Read only parameters will return an exception if an attempt is made to write values to them.

Data Formats

Data can be read or written in three formats: Integer Only, Integer with 1 Decimal Place and Floating Point Number.

The Modbus Address column shows the register address for each parameter in integer format. Other formats can be calculated from the Integer Only address.

When working in Hexadecimal, the format calculations are:

Address for Integer with 1 Decimal Place = Integer address plus 0x4000
Address for Floating Point = Integer address multiplied by 2, plus 0x8000

When working in Decimal, the format calculations are:

Address for Integer with 1 Decimal Place = Integer address plus 16384
Address for Floating Point = Integer address multiplied by 2, plus 32768

Example Register Address Calculations

Calculating Parameter Register Addresses				
		<i>Integer Only</i>	<i>Integer+1</i>	<i>Floating Point</i>
Register Address Calculation	<i>(hex)</i>	Address	Address + 0x4000	Address x 2 + 0x8000
	<i>(dec)</i>	Address	Address + 16384	Address x 2 + 32768
Address Example: (For Process Variable)	<i>(hex)</i>	0x0407	0x4407	0x880E
	<i>(dec)</i>	1031	17415	34830
Data Value Returned: If actual Value = 23.9 decimal	<i>(hex)</i>	0x00, 0x17	0x00, 0xEF	0x41, 0xBF, 0x33, 0x33
	<i>(dec)</i>	23	239	23.9 as floating decimal
Address Example: (For Selected Setpoint)	<i>(hex)</i>	0x101F	0x501F	0xA03E
	<i>(dec)</i>	4127	20511	41022
Data Value Returned: If Value = 1 (Alternative SP)	<i>(hex)</i>	0x00, 0x01	0x00, 0x0A	0x3F, 0x80, 0x00, 0x00
	<i>(dec)</i>	1	10	1.0 as floating decimal

Universal Process Input Parameters

Parameter Name	Modbus Address		Access	Values	
	(Dec)	(Hex)		Value	Process Input Type
Universal Process Input Type	1024	0x0400	R/W	0	B Type Thermocouple
				2	C Type Thermocouple
				4	D Type Thermocouple
				6	E Type Thermocouple
				8	J Type Thermocouple
				10	K Type Thermocouple
				12	L Type Thermocouple
				14	N Type Thermocouple
				16	R Type Thermocouple
				18	S Type Thermocouple
				20	T Type Thermocouple
				22	PtRh 20%: 40% Thermocouple
				24	PT100 RTD
				26	NI120 RTD
				28	0 to 20mA DC
				29	4 to 20mA DC
				30	0 to 50mV DC
				31	10 to 50mV DC
32	0 to 5V DC				
33	1 to 5V DC				
34	0 to 10V DC				
35	2 to 10V DC				
Engineering Units	1025	0x0401	R/W	Value	Engineering Units
				0	= None
				1	= °C (Default for Europe)
2	= °F (Default for USA)				
Maximum Display Decimal Places	1026	0x0402	R/W	Value	Decimal Places
				0	None (e.g. 1234)
				1	One (e.g. 123.4)
				2	Two (e.g. 12.34)
3	Three (e.g. 1.234)				
Range Minimum	1027	0x0403	R/W	Valid between input range maximum and minimum (see Specifications Section for input details)	
Range Maximum	1028	0x0404	R/W		
Process Variable Offset	1029	0x0405	R/W	Valid between scale range maximum and minimum	
Filter Time Constant	1030	0x0406	R/W	Valid between 0.0 and 512.0	
Process Variable	1031	0x0407	RO	The current process input value	
Input Signal /Sensor Break Flag	1032	0x0408	RO	Value	Process Input Break Status
				0	Inactive
				1	Active

Parameter Name	Modbus Address		Access	Values	
	(Dec)	(Hex)			
Input Signal Under Range Flag	1033	0x0409	RO	Value	Process Input Under Range Status
				0	Inactive
				1	Active
Input Signal Over Range Flag	1034	0x040A	RO	Value	Process Input Over Range Status
				0	Inactive
				1	Active
Cold Junction Compensation Enable/disable	1035	0x040B	R/W	Value	CJC Status
				0	Disabled
				1	Enabled (<i>default</i>)
Calibration Reminder Enable	1048	0x0418	R/W	Value	Calibration Reminder Status
				0	Disabled
				1	Enabled
Calibration Reminder Date	1049	0x0419	R/W	Data Format = ddmmyy where dd = day, mm = month and yy = year (e.g. 200308 is 20 th March 2008)	
Calibration Reminder Status	1052	0x041C	RO	Value	Calibration Status
				0	Calibration OK
				1	Calibration Required
Multi-point Scaling Enable	1053	0x041D	R/W	Value	Multi-point Scaling Status
				0	Disabled
				1	Enabled (<i>only if the input type is linear</i>)
Scale Point 1	1054	0x041E	R/W	0.1 to 100.0%	
Display Point 1	1055	0x041F	R/W	Valid between scale range maximum and minimum	
Scale Point 2	1056	0x0420	R/W	>Scale point 1 to 100.0%	
Display Point 2	1057	0x0421	R/W	Valid between scale range maximum and minimum	
Scale Point 3	1058	0x0422	R/W	>Scale point 2 to 100.0%	
Display Point 3	1059	0x0423	R/W	Valid between scale range maximum and minimum	
Scale Point 4	1060	0x0424	R/W	>Scale point 3 to 100.0%	
Display Point 4	1061	0x0425	R/W	Valid between scale range maximum and minimum	
Scale Point 5	1062	0x0426	R/W	>Scale point 4 to 100.0%	
Display Point 5	1063	0x0427	R/W	Valid between scale range maximum and minimum	
Scale Point 6	1064	0x0428	R/W	>Scale point 5 to 100.0%	
Display Point 6	1065	0x0429	R/W	Valid between scale range maximum and minimum	
Scale Point 7	1066	0x042A	R/W	>Scale point 6 to 100.0%	
Display Point 7	1067	0x042B	R/W	Valid between scale range maximum and minimum	
Scale Point 8	1068	0x042C	R/W	>Scale point 7 to 100.0%	
Display Point 8	1069	0x042D	R/W	Valid between scale range maximum and minimum	
Scale Point 9	1070	0x042E	R/W	>Scale point 8 to 100.0%	
Display Point 9	1071	0x042F	R/W	Valid between scale range maximum and minimum	
Scale Point 10	1072	0x0430	R/W	>Scale point 9 to 100.0%	
Display Point 10	1073	0x0431	R/W	Valid between scale range maximum and minimum	
Scale Point 11	1074	0x0432	R/W	>Scale point 10 to 100.0%	
Display Point 11	1075	0x0433	R/W	Valid between scale range maximum and minimum	
Scale Point 12	1076	0x0434	R/W	>Scale point 11 to 100.0%	
Display Point 12	1077	0x0435	R/W	Valid between scale range maximum and minimum	

Parameter Name	Modbus Address		Access	Values
	(Dec)	(Hex)		
Scale Point 13	1078	0x0436	R/W	>Scale point 12 to 100.0%
Display Point 13	1079	0x0437	R/W	Valid between scale range maximum and minimum
Scale Point 14	1080	0x0438	R/W	>Scale point 13 to 100.0%
Display Point 14	1081	0x0439	R/W	Valid between scale range maximum and minimum
Scale Point 15	1082	0x043A	R/W	>Scale point 14 to 100.0%
Display Point 15	1083	0x043B	R/W	Valid between scale range maximum and minimum

Option Slot A Parameters

Parameter Name	Modbus Address		Access	Values	
	(Dec)	(Hex)		Value	
Digital Input A Status	2115	0x0845	RO	Value	Digital Input A Status
				0	Inactive
				1	Active
Option Slot A Module Type	2116	0x0844	RO	Value	Module Fitted In Slot A
				0	None Fitted
				1	RS485 Communications
				3	Digital Input
				4	Auxiliary Input A
				255	Error (<i>unrecognised module</i>)
RS485 Address	2117	0x0845	R/W	Value	RS485 Address
				0	Modbus Master mode
				1 to 255	Modbus Slave Address
RS485 Data Rate	2118	0x0846	R/W	Value	Baud Rate
				0	4800
				1	9600
				2	19200 (<i>Default</i>)
				3	38400
				4	57600
RS485 Parity	2119	0x0847	R/W	Value	Parity
				0	None
				1	Even
Auxiliary Input A Type	2120	0x0848	R/W	Value	Auxiliary A Input Type
				0	0 to 20mA DC
				1	4 to 20mA DC
				2	0 to 10V DC
				3	2 to 10V DC
				4	0 to 5V DC
Target Setpoint Address	2121	0x0849	R/W	Target setpoint parameter address for master mode	

Parameter Name	Modbus Address		Access	Values	
	(Dec)	(Hex)		Value	Data Format
Master Transmit Format	2123	0x084B	R/W	0	Integer
				1	Integer with 1 decimal place
				2	Floating point number
Comms Write Enable/Disable	2124	0x084C	R/W	0	Writing via serial communications disabled
				1	Writing via serial communications enabled
Auxiliary Input A Input Signal Break	2127	0x084F	RO	0	Inactive
				1	Active
Auxiliary Input A Input Signal Under Range	2128	0x0850	RO	0	Inactive
				1	Active
Auxiliary Input A Input Signal Over Range	2129	0x0851	RO	0	Inactive
				1	Active

Option Slot B Parameters

Parameter Name	Modbus Address		Access	Values	
	(Dec)	(Hex)		Value	Data Format
Auxiliary Input B Type	2080	0x0820	R/W	0	0 to 20mA DC
				1	4 to 20mA DC
				2	0 to 10V DC
				3	2 to 10V DC
				4	0 to 5V DC
				5	1 to 5V DC
				6	0 to 100mV DC
				7	>2000 Ohm Potentiometer
Option Slot B Module Type	2081	0x0821	RO	0	None Fitted
				1	Auxiliary Input B with Digital Input B
				255	Error (<i>unrecognised module</i>)
Auxiliary Input B Input Signal Break	2082	0x0822	RO	0	Inactive
				1	Active
Auxiliary Input B Input Signal Under Range	2083	0x0823	RO	0	Inactive
				1	Active
Auxiliary Input B Input Signal Over Range	2084	0x0824	RO	0	Inactive
				1	Active

Parameter Name	Modbus Address		Access	Values	
	(Dec)	(Hex)		Value	
Digital Input B Status	2085	0x0825	RO	Value	Digital Input B Status
				0	Inactive
				1	Active
Calibration Status	2086	0x0826	RO	Value	Calibration Status
				0	Calibration OK
				1	Calibration Required

Option Slot 1 Parameters

Parameter Name	Modbus Address		Access	Values	
	(Dec)	(Hex)		Value	
Option Slot 1 Module Type	2130	0x0852	RO	Value	Module Fitted In Slot 1
				0	None Fitted
				1	Single Relay
				2	Single SSR Driver
				3	Linear mA/V DC
				255	Error (<i>unrecognised module</i>)
Linear mA/V DC Output 1 Type	2131	0x0853	R/W	Value	Linear Output 1 Type
				0	0 to 5V DC
				1	0 to 10V DC
				2	2 to 10V DC
				3	0 to 20mA DC
				5	Variable 0 to 10VDC Transmitter PSU
Digital Output 1 Status	2132	0x0854	RO	Value	Digital Output 1 Status
				0	Inactive
				1	Active
Linear Output 1 Level Status	2134	0x0856	RO	-2.0% to 102.0% of nominal range (<i>control output will over/under drive by 2%</i>).	
Linear Output 1 Function	2144	0x0860	R/W	Value	Linear Output 1 Function
				0	Disabled
				1	Primary Output Power
				2	Secondary Output Power
				4	Retransmit Process Variable Value
Digital Output 1 Function (<i>Relays, SSR Drivers or Triacs. Linear Outputs are mA or VDC</i>)	2146	0x0862	R/W	Value	Digital Output 1 Function
				0	Disabled
				1	Primary Output Power
				2	Secondary Output Power
				4	Alarm and Event
Output 1 Alarm Selection	2148	0x0864	R/W	Value	Output 1 Alarm Selection
				0	Alarm 1. Direct Acting

Parameter Name	Modbus Address		Access	Values	
	(Dec)	(Hex)			
				1	Alarm 1. Reverse Acting
				2	Alarm 2, Direct Acting
				3	Alarm 2. Reverse Acting
				4	Alarm 3. Direct Acting
				5	Alarm 3. Reverse Acting
				6	Alarm 4. Direct Acting
				7	Alarm 4. Reverse Acting
				8	Alarm 5. Direct Acting
				9	Alarm 5. Reverse Acting
				10	OR of Alarm 1 or 2. Direct
				11	OR of Alarm 1 or 2. Reverse
				12	OR of Alarm 1, 2, or 3. Direct
				13	OR of Alarm 1, 2, or 3. Reverse
				14	OR of Alarm 1, 2, 3, or 4. Direct
				15	OR of Alarm 1, 2, 3, or 4. Reverse
				16	OR of Alarm 1, 2, 3, 4 or 5. Direct
				17	OR of Alarm 1, 2, 3, 4 or 5. Reverse
Output 1 Event And Alarm Selection	2150	0x0866	R/W	Value	Output 1 Event And Alarm Selection
				0	Event 1. Direct Acting
				1	Event 1. Reverse Acting
				2	Event 2. Direct Acting
				3	Event 2. Reverse Acting
				4	Event 3. Direct Acting
				5	Event 3. Reverse Acting
				6	Event 4. Direct Acting
				7	Event 4. Reverse Acting
				8	Event 5. Direct Acting
				9	Event 5. Reverse Acting
				10	Profile Running. Direct Acting
				11	Profile Running. Reverse Acting
				12	End of Profile. Direct Acting
				13	End of Profile. Reverse Acting
				14	Event 1 AND Alarm 1. Direct Acting
				15	Event 1 AND Alarm 1. Reverse Acting
				16	Event 2 AND Alarm 2. Direct Acting
				17	Event 2 AND Alarm 2. Reverse Acting
				18	Event 3 AND Alarm 3. Direct Acting
				19	Event 3 AND Alarm 3. Reverse Acting
				20	Event 4 AND Alarm 4. Direct Acting
				21	Event 4 AND Alarm 4. Reverse Acting
				22	Event 5 AND Alarm 5. Direct Acting
23	Event 5 AND Alarm 5. Reverse Acting				
Output 1 Retransmit Minimum	2152	0x0868	R/W	Limited by input range maximum and minimum	
Output 1 Retransmit Maximum	2153	0x0869	R/W	Limited by input range maximum and minimum	

Option Slot 2 Parameters

Parameter Name	Modbus Address		Access	Values	
	(Dec)	(Hex)		Value	
Option Slot 2 Module Type	2160	0x0870	RO	Value	Module Fitted In Slot 2
				0	None Fitted
				1	Single Relay
				2	Single SSR Driver
				3	Linear mA/V DC
				8	Triac
				9	Dual Relay
				10	Dual SSR Driver
				11	24VDC Transmitter PSU
255	Error (<i>unrecognised module</i>)				
Linear mA/V DC Output 2 Type	2161	0x0871	R/W	Value	Linear Output 2 Type
				0	0 to 5V DC
				1	0 to 10V DC
				2	2 to 10V DC
				3	0 to 20mA DC
				4	4 to 20mA DC
Digital Output 2 or 2A Status	2162	0x0872	RO	Value	Digital Output 2 or 2A Status
				0	Inactive
				1	Active
Digital Output 2B Status	2163	0x0873	RO	Value	Digital Output 2B Status
				0	Inactive
				1	Active
Linear Output 2 Level Status	2164	0x0874	RO	-2.0% to 102.0% of nominal range (<i>control output will over/under drive by 2%</i>).	
Linear Output 2 or 2A Function	2174	0x087E	R/W	Value	Linear Output 2 or 2A Function
				0	Disabled
				1	Primary Output Power
				2	Secondary Output Power
				3	Retransmit Actual Setpoint Value
4	Retransmit Process Variable Value				
Digital Output 2 or 2A Function	2176	0x0880	R/W	Value	Digital Output 2 or 2A Function
				0	Disabled
				1	Primary Output Power
				2	Secondary Output Power
				3	Alarm
4	Alarm and Event				

Parameter Name	Modbus Address		Access	Values	
	(Dec)	(Hex)		Value	
Digital Output 2B Function	2177	0x0881	R/W	Value	Digital Output 2B Function
				0	Disabled
				1	Primary Output Power
				2	Secondary Output Power
				3	Alarm
Output 2 or 2A Alarm Selection	2178	0x0882	R/W	Value	Output 2 or 2A Alarm Selection
				0	Alarm 1. Direct Acting
				1	Alarm 1. Reverse Acting
				2	Alarm 2, Direct Acting
				3	Alarm 2. Reverse Acting
				4	Alarm 3. Direct Acting
				5	Alarm 3. Reverse Acting
				6	Alarm 4. Direct Acting
				7	Alarm 4. Reverse Acting
				8	Alarm 5. Direct Acting
				9	Alarm 5. Reverse Acting
				10	OR of Alarm 1 or 2. Direct
				11	OR of Alarm 1 or 2. Reverse
				12	OR of Alarm 1, 2, or 3. Direct
				13	OR of Alarm 1, 2, or 3. Reverse
				14	OR of Alarm 1, 2, 3, or 4. Direct
				15	OR of Alarm 1, 2, 3, or 4. Reverse
				Output 2B Alarm Selection	2179
0	Alarm 1. Direct Acting				
1	Alarm 1. Reverse Acting				
2	Alarm 2, Direct Acting				
3	Alarm 2. Reverse Acting				
4	Alarm 3. Direct Acting				
5	Alarm 3. Reverse Acting				
6	Alarm 4. Direct Acting				
7	Alarm 4. Reverse Acting				
8	Alarm 5. Direct Acting				
9	Alarm 5. Reverse Acting				
10	OR of Alarm 1 or 2. Direct				
11	OR of Alarm 1 or 2. Reverse				
12	OR of Alarm 1, 2, or 3. Direct				
13	OR of Alarm 1, 2, or 3. Reverse				
14	OR of Alarm 1, 2, 3, or 4. Direct				
15	OR of Alarm 1, 2, 3, or 4. Reverse				
16	OR of Alarm 1, 2, 3, 4 or 5. Direct				
17	OR of Alarm 1, 2, 3, 4 or 5. Reverse				

Parameter Name	Modbus Address		Access	Values	
	(Dec)	(Hex)		Value	
Output 2 or 2A Event And Alarm Selection	2180	0x0884	R/W		Output 2 or 2A Event/Alarm Selection
				0	Event 1. Direct Acting
				1	Event 1. Reverse Acting
				2	Event 2. Direct Acting
				3	Event 2. Reverse Acting
				4	Event 3. Direct Acting
				5	Event 3. Reverse Acting
				6	Event 4. Direct Acting
				7	Event 4. Reverse Acting
				8	Event 5. Direct Acting
				9	Event 5. Reverse Acting
				10	Profile Running. Direct Acting
				11	Profile Running. Reverse Acting
				12	End of Profile. Direct Acting
				13	End of Profile. Reverse Acting
				14	Event 1 AND Alarm 1. Direct Acting
				15	Event 1 AND Alarm 1. Reverse Acting
				16	Event 2 AND Alarm 2. Direct Acting
				17	Event 2 AND Alarm 2. Reverse Acting
				18	Event 3 AND Alarm 3. Direct Acting
				19	Event 3 AND Alarm 3. Reverse Acting
				20	Event 4 AND Alarm 4. Direct Acting
				21	Event 4 AND Alarm 4. Reverse Acting
				22	Event 5 AND Alarm 5. Direct Acting
23	Event 5 AND Alarm 5. Reverse Acting				
Output 2B Event And Alarm Selection	2181	0x0885	R/W		Output 2B Event/Alarm Selection
				0	Event 1. Direct Acting
				1	Event 1. Reverse Acting
				2	Event 2. Direct Acting
				3	Event 2. Reverse Acting
				4	Event 3. Direct Acting
				5	Event 3. Reverse Acting
				6	Event 4. Direct Acting
				7	Event 4. Reverse Acting
				8	Event 5. Direct Acting
				9	Event 5. Reverse Acting
				10	Profile Running. Direct Acting
				11	Profile Running. Reverse Acting
				12	End of Profile. Direct Acting
				13	End of Profile. Reverse Acting
				14	Event 1 AND Alarm 1. Direct Acting
				15	Event 1 AND Alarm 1. Reverse Acting
				16	Event 2 AND Alarm 2. Direct Acting
				17	Event 2 AND Alarm 2. Reverse Acting
				18	Event 3 AND Alarm 3. Direct Acting
19	Event 3 AND Alarm 3. Reverse Acting				

Parameter Name	Modbus Address		Access	Values	
	(Dec)	(Hex)			
				20	Event 4 AND Alarm 4. Direct Acting
				21	Event 4 AND Alarm 4. Reverse Acting
				22	Event 5 AND Alarm 5. Direct Acting
				23	Event 5 AND Alarm 5. Reverse Acting
Output 2 Retransmit Minimum	2182	0x0886	R/W	Limited by input range maximum/minimum	
Output 2 Retransmit Maximum	2183	0x0887	R/W	Limited by input range maximum/minimum	

Option Slot 3 Parameters

Parameter Name	Modbus Address		Access	Values	
	(Dec)	(Hex)			
Option Slot 3 Module Type	2192	0x0890	RO	Value	Module Fitted In Slot 3
				0	None Fitted
				1	Single Relay
				2	Single SSR Driver
				3	Linear mA/V DC
				8	Triac
				9	Dual Relay
				10	Dual SSR Driver
				255	Error (<i>unrecognised module</i>)
Linear mA/V DC Output 3 Type	2193	0x0891	R/W	Value	Linear Output 3 Type
				0	0 to 5V DC
				1	0 to 10V DC
				2	2 to 10V DC
				3	0 to 20mA DC
				4	4 to 20mA DC
Digital Output 3 or 3A Status	2194	0x0892	RO	Value	Digital Output 3 or 3A Status
				0	Inactive
				1	Active
Digital Output 3B Status	2195	0x0893	RO	Value	Digital Output 3B Status
				0	Inactive
				1	Active
Linear Output 3 Level Status	2196	0x0894	RO	-2.0% to 102.0% of nominal range (<i>control output will over/under drive by 2%</i>).	
Linear Output 3 or 3A Function	2203	0x089B	R/W	Value	Linear Output 3 or 3A Function
				0	Disabled
				1	Primary Output Power
				2	Secondary Output Power
				3	Retransmit Actual Setpoint Value
4	Retransmit Process Variable Value				

Parameter Name	Modbus Address		Access	Values	
	(Dec)	(Hex)		Value	
Digital Output 3 or 3A Function	2205	0x089D	R/W	Value	Digital Output 3 or 3A Function
				0	Disabled
				1	Primary Output Power
				2	Secondary Output Power
				3	Alarm
Digital Output 3B Function	2206	0x089E	R/W	Value	Digital Output 3B Function
				0	Disabled
				1	Primary Output Power
				2	Secondary Output Power
				3	Alarm
Output 3 or 3A Alarm Selection	2207	0x089F	R/W	Value	Output 3 or 3A Alarm Selection
				0	Alarm 1. Direct Acting
				1	Alarm 1. Reverse Acting
				2	Alarm 2. Direct Acting
				3	Alarm 2. Reverse Acting
				4	Alarm 3. Direct Acting
				5	Alarm 3. Reverse Acting
				6	Alarm 4. Direct Acting
				7	Alarm 4. Reverse Acting
				8	Alarm 5. Direct Acting
				9	Alarm 5. Reverse Acting
				10	OR of Alarm 1 or 2. Direct
				11	OR of Alarm 1 or 2. Reverse
				12	OR of Alarm 1, 2, or 3. Direct
				13	OR of Alarm 1, 2, or 3. Reverse
				14	OR of Alarm 1, 2, 3, or 4. Direct
				15	OR of Alarm 1, 2, 3, or 4. Reverse
16	OR of Alarm 1, 2, 3, 4 or 5. Direct				
17	OR of Alarm 1, 2, 3, 4 or 5. Reverse				
Output 3B Alarm Selection	2208	0x08A0	R/W	Value	Output 3B Alarm Selection
				0	Alarm 1. Direct Acting
				1	Alarm 1. Reverse Acting
				2	Alarm 2. Direct Acting
				3	Alarm 2. Reverse Acting
				4	Alarm 3. Direct Acting
				5	Alarm 3. Reverse Acting
				6	Alarm 4. Direct Acting
				7	Alarm 4. Reverse Acting
				8	Alarm 5. Direct Acting
				9	Alarm 5. Reverse Acting
				10	OR of Alarm 1 or 2. Direct
11	OR of Alarm 1 or 2. Reverse				
12	OR of Alarm 1, 2, or 3. Direct				

Parameter Name	Modbus Address		Access	Values	
	(Dec)	(Hex)			
				13	OR of Alarm 1, 2, or 3. Reverse
				14	OR of Alarm 1, 2, 3, or 4. Direct
				15	OR of Alarm 1, 2, 3, or 4. Reverse
				16	OR of Alarm 1, 2, 3, 4 or 5. Direct
				17	OR of Alarm 1, 2, 3, 4 or 5. Reverse
Output 3 or 3A Event And Alarm Selection	2209	0x08A1	R/W	Value	Output 3 or 3A Event/Alarm Selection
				0	Event 1. Direct Acting
				1	Event 1. Reverse Acting
				2	Event 2. Direct Acting
				3	Event 2. Reverse Acting
				4	Event 3. Direct Acting
				5	Event 3. Reverse Acting
				6	Event 4. Direct Acting
				7	Event 4. Reverse Acting
				8	Event 5. Direct Acting
				9	Event 5. Reverse Acting
				10	Profile Running. Direct Acting
				11	Profile Running. Reverse Acting
				12	End of Profile. Direct Acting
				13	End of Profile. Reverse Acting
				14	Event 1 AND Alarm 1. Direct Acting
				15	Event 1 AND Alarm 1. Reverse Acting
				16	Event 2 AND Alarm 2. Direct Acting
				17	Event 2 AND Alarm 2. Reverse Acting
				18	Event 3 AND Alarm 3. Direct Acting
				19	Event 3 AND Alarm 3. Reverse Acting
				20	Event 4 AND Alarm 4. Direct Acting
				21	Event 4 AND Alarm 4. Reverse Acting
				22	Event 5 AND Alarm 5. Direct Acting
23	Event 5 AND Alarm 5. Reverse Acting				
Output 3B Event And Alarm Selection	2210	0x08A2	R/W	Value	Output 3B Event/Alarm Selection
				0	Event 1. Direct Acting
				1	Event 1. Reverse Acting
				2	Event 2. Direct Acting
				3	Event 2. Reverse Acting
				4	Event 3. Direct Acting
				5	Event 3. Reverse Acting
				6	Event 4. Direct Acting
				7	Event 4. Reverse Acting
				8	Event 5. Direct Acting
				9	Event 5. Reverse Acting
				10	Profile Running. Direct Acting
				11	Profile Running. Reverse Acting
				12	End of Profile. Direct Acting
13	End of Profile. Reverse Acting				

Parameter Name	Modbus Address		Access	Values	
	(Dec)	(Hex)			
				14	Event 1 AND Alarm 1. Direct Acting
				15	Event 1 AND Alarm 1. Reverse Acting
				16	Event 2 AND Alarm 2. Direct Acting
				17	Event 2 AND Alarm 2. Reverse Acting
				18	Event 3 AND Alarm 3. Direct Acting
				19	Event 3 AND Alarm 3. Reverse Acting
				20	Event 4 AND Alarm 4. Direct Acting
				21	Event 4 AND Alarm 4. Reverse Acting
				22	Event 5 AND Alarm 5. Direct Acting
				23	Event 5 AND Alarm 5. Reverse Acting
Output 3 Retransmit Minimum	2211	0x08A3	R/W	Limited by input range maximum/minimum	
Output 3 Retransmit Maximum	2212	0x08A4	R/W	Limited by input range maximum/minimum	

Option Slot 4 Parameters

Parameter Name	Modbus Address		Access	Values	
	(Dec)	(Hex)			
Option Slot 4 Module Type	2222	0x08AE	RO	Value	Module Fitted In Slot 4
				0	None Fitted
				1	Quad Relay
				255	Error (<i>unrecognised module</i>)
Digital Output 4 Status	2223	0x08AF	RO	Value	Digital Output 4A, 4B, 4C & 4D Status
				0	All outputs inactive
				Bit 0	Output 4A Active
				Bit 1	Output 4B Active
				Bit 2	Output 4C Active
Digital Output 4A Function	2230	0x08B6	R/W	Value	Digital Output 4A Function
				0	Disabled
				1	Primary Output Power
				2	Secondary Output Power
				3	Alarm
Digital Output 4B Function	2231	0x08B7	R/W	Value	Digital Output 4B Function
				0	Disabled
				1	Primary Output Power
				2	Secondary Output Power
				3	Alarm
				4	Alarm and Event

Parameter Name	Modbus Address		Access	Values	
	(Dec)	(Hex)		Value	
Digital Output 4C Function	2232	0x08B8	R/W	Value	Digital Output 4C Function
				0	Disabled
				1	Primary Output Power
				2	Secondary Output Power
				3	Alarm
Digital Output 4D Function	2233	0x08B9	R/W	Value	Digital Output 4D Function
				0	Disabled
				1	Primary Output Power
				2	Secondary Output Power
				3	Alarm
Output 4A Alarm Selection	2234	0x08BA	R/W	Value	Output 4A Alarm Selection
				0	Alarm 1. Direct Acting
				1	Alarm 1. Reverse Acting
				2	Alarm 2. Direct Acting
				3	Alarm 2. Reverse Acting
				4	Alarm 3. Direct Acting
				5	Alarm 3. Reverse Acting
				6	Alarm 4. Direct Acting
				7	Alarm 4. Reverse Acting
				8	Alarm 5. Direct Acting
				9	Alarm 5. Reverse Acting
				10	OR of Alarm 1 or 2. Direct
				11	OR of Alarm 1 or 2. Reverse
				12	OR of Alarm 1, 2, or 3. Direct
				13	OR of Alarm 1, 2, or 3. Reverse
				14	OR of Alarm 1, 2, 3, or 4. Direct
				15	OR of Alarm 1, 2, 3, or 4. Reverse
				Output 4B Alarm Selection	2235
0	Alarm 1. Direct Acting				
1	Alarm 1. Reverse Acting				
2	Alarm 2. Direct Acting				
3	Alarm 2. Reverse Acting				
4	Alarm 3. Direct Acting				
5	Alarm 3. Reverse Acting				
6	Alarm 4. Direct Acting				
7	Alarm 4. Reverse Acting				
8	Alarm 5. Direct Acting				
9	Alarm 5. Reverse Acting				
10	OR of Alarm 1 or 2. Direct				
11	OR of Alarm 1 or 2. Reverse				
12	OR of Alarm 1, 2, or 3. Direct				

Parameter Name	Modbus Address		Access	Values	
	(Dec)	(Hex)			
				13	OR of Alarm 1, 2, or 3. Reverse
				14	OR of Alarm 1, 2, 3, or 4. Direct
				15	OR of Alarm 1, 2, 3, or 4. Reverse
				16	OR of Alarm 1, 2, 3, 4 or 5. Direct
				17	OR of Alarm 1, 2, 3, 4 or 5. Reverse
Output 4C Alarm Selection	2236	0x08BC	R/W	Value	Output 4C Alarm Selection
				0	Alarm 1. Direct Acting
				1	Alarm 1. Reverse Acting
				2	Alarm 2. Direct Acting
				3	Alarm 2. Reverse Acting
				4	Alarm 3. Direct Acting
				5	Alarm 3. Reverse Acting
				6	Alarm 4. Direct Acting
				7	Alarm 4. Reverse Acting
				8	Alarm 5. Direct Acting
				9	Alarm 5. Reverse Acting
				10	OR of Alarm 1 or 2. Direct
				11	OR of Alarm 1 or 2. Reverse
				12	OR of Alarm 1, 2, or 3. Direct
				13	OR of Alarm 1, 2, or 3. Reverse
				14	OR of Alarm 1, 2, 3, or 4. Direct
				15	OR of Alarm 1, 2, 3, or 4. Reverse
				16	OR of Alarm 1, 2, 3, 4 or 5. Direct
17	OR of Alarm 1, 2, 3, 4 or 5. Reverse				
Output 4D Alarm Selection	2237	0x08BD	R/W	Value	Output 4D Alarm Selection
				0	Alarm 1. Direct Acting
				1	Alarm 1. Reverse Acting
				2	Alarm 2. Direct Acting
				3	Alarm 2. Reverse Acting
				4	Alarm 3. Direct Acting
				5	Alarm 3. Reverse Acting
				6	Alarm 4. Direct Acting
				7	Alarm 4. Reverse Acting
				8	Alarm 5. Direct Acting
				9	Alarm 5. Reverse Acting
				10	OR of Alarm 1 or 2. Direct
				11	OR of Alarm 1 or 2. Reverse
				12	OR of Alarm 1, 2, or 3. Direct
				13	OR of Alarm 1, 2, or 3. Reverse
				14	OR of Alarm 1, 2, 3, or 4. Direct
				15	OR of Alarm 1, 2, 3, or 4. Reverse
				16	OR of Alarm 1, 2, 3, 4 or 5. Direct
17	OR of Alarm 1, 2, 3, 4 or 5. Reverse				

Parameter Name	Modbus Address		Access	Values	
	(Dec)	(Hex)		Value	
Output 4A Event And Alarm Selection	2238	0x08BE	R/W		Output 4A Event/Alarm Selection
				0	Event 1. Direct Acting
				1	Event 1. Reverse Acting
				2	Event 2. Direct Acting
				3	Event 2. Reverse Acting
				4	Event 3. Direct Acting
				5	Event 3. Reverse Acting
				6	Event 4. Direct Acting
				7	Event 4. Reverse Acting
				8	Event 5. Direct Acting
				9	Event 5. Reverse Acting
				10	Profile Running. Direct Acting
				11	Profile Running. Reverse Acting
				12	End of Profile. Direct Acting
				13	End of Profile. Reverse Acting
				14	Event 1 AND Alarm 1. Direct Acting
				15	Event 1 AND Alarm 1. Reverse Acting
				16	Event 2 AND Alarm 2. Direct Acting
				17	Event 2 AND Alarm 2. Reverse Acting
				18	Event 3 AND Alarm 3. Direct Acting
				19	Event 3 AND Alarm 3. Reverse Acting
				20	Event 4 AND Alarm 4. Direct Acting
				21	Event 4 AND Alarm 4. Reverse Acting
				22	Event 5 AND Alarm 5. Direct Acting
23	Event 5 AND Alarm 5. Reverse Acting				
Output 4B Event And Alarm Selection	2239	0x08BF	R/W		Output 4B Event/Alarm Selection
				0	Event 1. Direct Acting
				1	Event 1. Reverse Acting
				2	Event 2. Direct Acting
				3	Event 2. Reverse Acting
				4	Event 3. Direct Acting
				5	Event 3. Reverse Acting
				6	Event 4. Direct Acting
				7	Event 4. Reverse Acting
				8	Event 5. Direct Acting
				9	Event 5. Reverse Acting
				10	Profile Running. Direct Acting
				11	Profile Running. Reverse Acting
				12	End of Profile. Direct Acting
				13	End of Profile. Reverse Acting
				14	Event 1 AND Alarm 1. Direct Acting
				15	Event 1 AND Alarm 1. Reverse Acting
				16	Event 2 AND Alarm 2. Direct Acting
				17	Event 2 AND Alarm 2. Reverse Acting
18	Event 3 AND Alarm 3. Direct Acting				

Parameter Name	Modbus Address		Access	Values	
	(Dec)	(Hex)			
				19	Event 3 AND Alarm 3. Reverse Acting
				20	Event 4 AND Alarm 4. Direct Acting
				21	Event 4 AND Alarm 4. Reverse Acting
				22	Event 5 AND Alarm 5. Direct Acting
				23	Event 5 AND Alarm 5. Reverse Acting
Output 4C Event And Alarm Selection	2240	0x08C0	R/W	Value	Output 4C Event/Alarm Selection
				0	Event 1. Direct Acting
				1	Event 1. Reverse Acting
				2	Event 2. Direct Acting
				3	Event 2. Reverse Acting
				4	Event 3. Direct Acting
				5	Event 3. Reverse Acting
				6	Event 4. Direct Acting
				7	Event 4. Reverse Acting
				8	Event 5. Direct Acting
				9	Event 5. Reverse Acting
				10	Profile Running. Direct Acting
				11	Profile Running. Reverse Acting
				12	End of Profile. Direct Acting
				13	End of Profile. Reverse Acting
				14	Event 1 AND Alarm 1. Direct Acting
				15	Event 1 AND Alarm 1. Reverse Acting
				16	Event 2 AND Alarm 2. Direct Acting
				17	Event 2 AND Alarm 2. Reverse Acting
				18	Event 3 AND Alarm 3. Direct Acting
				19	Event 3 AND Alarm 3. Reverse Acting
				20	Event 4 AND Alarm 4. Direct Acting
				21	Event 4 AND Alarm 4. Reverse Acting
				22	Event 5 AND Alarm 5. Direct Acting
23	Event 5 AND Alarm 5. Reverse Acting				
Output 4D Event And Alarm Selection	2241	0x08C1	R/W	Value	Output 4D Event/Alarm Selection
				0	Event 1. Direct Acting
				1	Event 1. Reverse Acting
				2	Event 2. Direct Acting
				3	Event 2. Reverse Acting
				4	Event 3. Direct Acting
				5	Event 3. Reverse Acting
				6	Event 4. Direct Acting
				7	Event 4. Reverse Acting
				8	Event 5. Direct Acting
				9	Event 5. Reverse Acting
				10	Profile Running. Direct Acting
				11	Profile Running. Reverse Acting
				12	End of Profile. Direct Acting
13	End of Profile. Reverse Acting				

Parameter Name	Modbus Address		Access	Values	
	(Dec)	(Hex)			
				14	Event 1 AND Alarm 1. Direct Acting
				15	Event 1 AND Alarm 1. Reverse Acting
				16	Event 2 AND Alarm 2. Direct Acting
				17	Event 2 AND Alarm 2. Reverse Acting
				18	Event 3 AND Alarm 3. Direct Acting
				19	Event 3 AND Alarm 3. Reverse Acting
				20	Event 4 AND Alarm 4. Direct Acting
				21	Event 4 AND Alarm 4. Reverse Acting
				22	Event 5 AND Alarm 5. Direct Acting
				23	Event 5 AND Alarm 5. Reverse Acting

Setpoint Parameters

Parameter Name	Modbus Address		Access	Values	
	(Dec)	(Hex)			
Setpoint Minimum	3944	0x0F68	R/W	Valid between Scale Range Maximum and Minimum	
Setpoint Maximum	3945	0x0F69	R/W	Valid between Scale Range Maximum and Minimum	
Local Setpoint 1 Value	3960	0x0F78	R/W	Valid between Setpoint Maximum and Minimum	
Local Setpoint 1 Offset	3961	0x0F79	R/W	Setpoint is always limited within Setpoint Maximum and Minimum	
Local Setpoint 2 Value	3962	0x0F7A	R/W	Valid between Setpoint Maximum and Minimum	
Local Setpoint 2 Offset	3963	0x0F7B	R/W	Setpoint is always limited within Setpoint Maximum and Minimum	
Setpoint Selection Method	4000	0x0FA0	R/W	Value	Setpoint Selection Method
				0	Local Setpoint 1 only
				1	Selected by Digital Input A
				2	Selected by Digital Input B
				3	Alternate Setpoint only
				4	Operator or Comms selectable
Alternate Setpoint Source	4001	0x0FA1	R/W	Value	Alternate Setpoint Source
				0	Local Setpoint 2
				1	Remote Setpoint from Auxiliary Input A
				2	Remote Setpoint from Auxiliary Input B
Auxiliary Input A Scale Minimum	4073	0x0FE9	R/W	Valid between Setpoint Maximum and Minimum	
Auxiliary Input A Scale Maximum	4074	0x0FEA	R/W	Valid between Setpoint Maximum and Minimum	
Auxiliary Input A Offset	4075	0x0FEB	R/W	Setpoint is always limited within Setpoint Maximum and Minimum	
Auxiliary Input A Value	4076	0x0FEC	RO	The value of analogue Auxiliary Input A	
Auxiliary Input B Scale Minimum	4078	0x0FEE	R/W	Valid between Setpoint Maximum and Minimum	
Auxiliary Input B Scale Maximum	4079	0x0FEF	R/W	Valid between Setpoint Maximum and Minimum	

Parameter Name	Modbus Address		Access	Values	
	(Dec)	(Hex)			
Auxiliary Input B Offset	4080	0x0FF0	R/W	Setpoint is always limited within Setpoint Maximum and Minimum	
Auxiliary Input B Value	4081	0x0FF1	RO	The value of analogue Auxiliary Input B	
User Setpoint Select	4122	0x101A	R/W	Value	Setpoint Select
				0	Local Setpoint 1
				1	Alternate setpoint
Setpoint Ramp Rate	4123	0x101B	R/W	0 to 10000 0 or >10000 = Off	
Target Setpoint	4125	0x101D	RO	The target setpoint value when ramping	
Operator Access To Setpoint Ramp Rate	4126	0x101E	R/W	Value	Operator Access To Ramp Rate
				0	Disabled
				1	Enabled
Selected Setpoint	4127	0x101F	RO	Value	Selected Setpoint
				0	Local Setpoint 1
				1	Alternate setpoint
Actual Setpoint	8256	0x2040	RO	The current instantaneous value of the active setpoint	

Control Parameters

Parameter Name	Modbus Address		Access	Values	
	(Dec)	(Hex)			
Manual Control Select Method	4299	0x10CB	R/W	Value	Manual Control Selection Method
				0	Automatic Control Only
				1	Manual Control Only
				2	User Selectable From Key Pad
				3	Digital input A
				4	Digital input B
Control Enable Select Method	4300	0x10CC	R/W	Value	Control Enable Selection Method
				0	Enabled Only
				1	Disabled Only
				2	User Selectable From Key Pad
				3	Digital input A
				4	Digital input B
Primary Cycle Time	4301	0x10CD	R/W	0.5 to 512.0 Seconds	
Secondary Cycle Time	4302	0x10CE	R/W	0.5 to 512.0 Seconds	
Control type	4310	0x10D6	R/W	Value	Control Type
				0	Single Control
				1	Dual Control
Control Action	4311	0x10D7	R/W	Value	Control Type
				0	Direct Acting
				1	Reverse Acting
Primary Proportional Band	4312	0x10D8	R/W	0.0 to 999.9 (% of Input Span)	
Secondary	4313	0x10D9	R/W	0.0 to 999.9 (% of Input Span)	

Parameter Name	Modbus Address		Access	Values	
	(Dec)	(Hex)			
Proportional Band					
Integral Time Constant	4314	0x10DA	R/W	0.0 to 5999 Seconds	
Derivative Time Constant	4315	0x10DB	R/W	0.0 to 5999 Seconds	
Bias	4316	0x10DC	R/W	For single control 0 to 100. For Dual control -100 to 100	
Overlap/Deadband	4317	0x10DD	R/W	-100 to 100	
On/Off Differential	4320	0x10E0	R/W	0.1 to 100	
Primary Power Upper limit	4321	0x10E1	R/W	10 to 100% Can not be made smaller than Primary Lower limit + 10	
Heat/Primary Power Lower limit	4322	0x10E2	R/W	0 to 90% Can not be made larger than Heat/Primary Upper limit – 10	
Cool/Secondary Upper Power limit	4323	0x10E3	R/W	10 to 100% Can not be made smaller than Cool/Secondary Lower limit + 10	
Cool/Secondary Power Lower limit	4324	0x10E4	R/W	0 to 90% Can not be made larger than Cool/Secondary Upper limit – 10	
Pre-Tune Engage/disengage	4325	0x10E5	R/W	Value	Pre-Tune Engage/disengage
				0	Pre-Tune OFF
				1	Run Pre-Tune
Self-Tune Engage/disengage	4326	0x10E6	R/W	Value	Self-Tune Engage/disengage
				0	Self-Tune OFF
				1	Self-Tune ON
Loop Alarm Type	4327	0x10E7	R/W	Value	Loop Alarm Type
				1	Timed
				2	Automatic (2x Integral Time)
Loop Alarm Time	4328	0x10E8	R/W	1 to 5999 Seconds after output saturation	
Primary Power	4329	0x10E9	RO	The current primary power (0 to 100%)	
Secondary Power	4330	0x10EA	RO	The current secondary power (0 to 100%)	
Combined Power	4331	0x10EB	RO	The current combined PID power (-100 to 100%)	
Pre-Tune Status	4332	0x10EC	RO	Value	Pre-Tune Status
				0	Inactive
				1	Active
Self-Tune Status	4333	0x10ED	RO	Value	Self-Tune Status
				0	Inactive
				1	Active
Loop Alarm status	4334	0x10EE	RO	Value	Loop Alarm Status
				0	Inactive
				1	Active
Input Failure Preset Power	4335	0x10EF	R/W	Power output required if input signal is lost 0 to 100% (-100% to 100% for dual control).	
Auto Pre-tune	4336	0x10F0	R/W	Value	Auto Pre-Tune
				0	Disabled
				1	Enabled

Alarm parameters

Parameter Name	Modbus Address		Access	Values	
	(Dec)	(Hex)		Value	
Alarm 1 Type	6144	0x1800	R/W	Value	Alarm 1 Type
				0	Process High Alarm
				1	Process Low Alarm
				2	Deviation Alarm (SP-PV)
				3	Band Alarm
				4	Loop Alarm
				5	Input/Sensor Break Alarm
				6	Auxiliary Input A Break Alarm
7	Auxiliary Input B Break Alarm				
Alarm 1 Value	6145	0x1801	R/W	Limited by the input range maximum and minimum for Alarm types 0 and 1. Limited by the input span for alarm types 2 and 3. Not used for alarms 4 to 7.	
Alarm 1 Hysteresis	6146	0x1802	R/W	Limited by the input span	
Alarm 1 Inhibit Enable/disable	6147	0x1803	R/W	Value	Alarm 1 Inhibit Enable
				0	Disabled
				1	Enabled
Alarm 1 Status	6148	0x1804	RO	Value	Alarm 1 Status
				0	Inactive
				1	Active
Alarm 1 Inhibit Status	6149	0x1805	RO	Value	Alarm 1 Inhibit Status
				0	Not Inhibited
				1	Inhibited
Alarm 2 Type	6160	0x1810	R/W	Value	Alarm 2 Type
				0	Process High Alarm
				1	Process Low Alarm
				2	Deviation Alarm (SP-PV)
				3	Band Alarm
				4	Loop Alarm
				5	Input/Sensor Break Alarm
				6	Auxiliary Input A Break Alarm
7	Auxiliary Input B Break Alarm				
Alarm 2 Value	6161	0x1811	R/W	Limited by the input range maximum and minimum for Alarm types 0 and 1. Limited by the input span for alarm types 2 and 3. Not used for alarms 4 to 7.	
Alarm 2 Hysteresis	6162	0x1812	R/W	Limited by the input span	
Alarm 2 Inhibit Enable/disable	6163	0x1813	R/W	Value	Alarm 2 Inhibit Enable
				0	Disabled
				1	Enabled
Alarm 2 Status	6164	0x1814	RO	Value	Alarm 2 Status
				0	Inactive
				1	Active
Alarm 2 Inhibit Status	6165	0x1815	RO	Value	Alarm 2 Inhibit Status
				0	Not Inhibited

Parameter Name	Modbus Address		Access	Values	
	(Dec)	(Hex)			
				1	Inhibited
Alarm 3 Type	6176	0x1820	R/W	Value	Alarm 3 Type
				0	Process High Alarm
				1	Process Low Alarm
				2	Deviation Alarm (SP-PV)
				3	Band Alarm
				4	Loop Alarm
				5	Input/Sensor Break Alarm
				6	Auxiliary Input A Break Alarm
			7	Auxiliary Input B Break Alarm	
Alarm 3 Value	6177	0x1821	R/W	Limited by the input range maximum and minimum for Alarm types 0 and 1. Limited by the input span for alarm types 2 and 3. Not used for alarms 4 to 7.	
Alarm 3 Hysteresis	6178	0x1822	R/W	Limited by the input span	
Alarm 3 Inhibit Enable/disable	6179	0x1823	R/W	Value	Alarm 3 Inhibit Enable
				0	Disabled
				1	Enabled
Alarm 3 Status	6180	0x1824	RO	Value	Alarm 3 Status
				0	Inactive
				1	Active
Alarm 3 Inhibit Status	6181	0x1825	RO	Value	Alarm 3 Inhibit Status
				0	Not Inhibited
				1	Inhibited
Alarm 4 Type	6192	0x1830	R/W	Value	Alarm 4 Type
				0	Process High Alarm
				1	Process Low Alarm
				2	Deviation Alarm (SP-PV)
				3	Band Alarm
				4	Loop Alarm
				5	Input/Sensor Break Alarm
				6	Auxiliary Input A Break Alarm
			7	Auxiliary Input B Break Alarm	
Alarm 4 Value	6193	0x1831	R/W	Limited by the input range maximum and minimum for Alarm types 0 and 1. Limited by the input span for alarm types 2 and 3. Not used for alarms 4 to 7.	
Alarm 4 Hysteresis	6194	0x1832	R/W	Limited by the input span	
Alarm 4 Inhibit Enable/disable	6195	0x1833	R/W	Value	Alarm 4 Inhibit Enable
				0	Disabled
				1	Enabled
Alarm 4 Status	6196	0x1834	RO	Value	Alarm 4 Status
				0	Inactive
				1	Active
Alarm 4 Inhibit Status	6197	0x1835	RO	Value	Alarm 4 Inhibit Status
				0	Not Inhibited
				1	Inhibited

Parameter Name	Modbus Address		Access	Values	
	(Dec)	(Hex)		Value	
Alarm 5 Type	6208	0x1840	R/W	Value	Alarm 5 Type
				0	Process High Alarm
				1	Process Low Alarm
				2	Deviation Alarm (SP-PV)
				3	Band Alarm
				4	Loop Alarm
				5	Input/Sensor Break Alarm
				6	Auxiliary Input A Break Alarm
7	Auxiliary Input B Break Alarm				
Alarm 5 Value	6209	0x1841	R/W	Limited by the input range maximum and minimum for Alarm types 0 and 1. Limited by the input span for alarm types 2 and 3. Not used for alarms 4 to 7.	
Alarm 5 Hysteresis	6210	0x1842	R/W	Limited by the input span	
Alarm 5 Inhibit Enable/disable	6211	0x1843	R/W	Value	Alarm 5 Inhibit Enable
				0	Disabled
				1	Enabled
Alarm 5 Status	6212	0x1844	RO	Value	Alarm 5 Status
				0	Inactive
				1	Active
Alarm 5 Inhibit Status	6213	0x1845	RO	Value	Alarm 5 Inhibit Status
				0	Not Inhibited
				1	Inhibited

Recorder & Clock Parameters

Parameter Name	Modbus Address		Access	Values	
	(Dec)	(Hex)		Value	
Recording Sample Interval	7550	0x1D7E	R/W	Value	Recording Sample Interval
				0	Every Second
				1	Every 2 Seconds
				2	Every 5 Seconds
				3	Every 10 Seconds
				4	Every 15 Seconds
				5	Every 30 Seconds
				6	Every Minute
				7	Every 2 Minutes
				8	Every 5 Minutes
				9	Every 10 Minutes
				10	Every 15 Minutes
11	Every 30 Minutes				
Recording Mode	7551	0x1D7F	R/W	Value	Recording Mode
				0	Record until memory used
				1	Continuous FIFO buffer
Start Stop Recording	7552	0x1D80	R/W	Value	Operator Start/Stop Recording
				0	Stop Recording

Parameter Name	Modbus Address		Access	Values	
	(Dec)	(Hex)			
				1	Start Recording
Data Recorder Fitted	7553	0x1D81	RO	Value	Data Recorder Fitted
				0	Not Fitted
				1	Recorder Fitted
Memory Remaining	7554	0x1D82	RO	Memory unused remaining left, in bytes	
Time Remaining	7555	0x1D83	RO	Time remaining until memory is used up, in seconds	
Recorder Trigger	7563	0x1D8B	R/W	Value	Recorder Trigger
				0	Operator start/stop
				1	Recorder Menu start/stop
				2	On Alarm (see Alarm 1-5 trigger below)
				3	Digital input A
				4	Digital input B
Record Process Variable	7572	0x1D94	R/W	Value	Record Process Variable
				0	Do Not Record PV
				1	Record PV Value
Record Maximum PV Between Samples	7573	0x1D95	R/W	Value	Record Max PV Since Last Sample
				0	Do Not Record Maximum PV
				1	Record Maximum PV Between Samples
Record Minimum PV Between Samples	7574	0x1D96	R/W	Value	Record Min PV Since Last Sample
				0	Do Not Record Minimum PV
				1	Record Minimum PV Between Samples
Record Actual Setpoint	7575	0x1D97	R/W	Value	Record Actual Setpoint Value
				0	Do Not Record Setpoint
				1	Record Actual Setpoint
Record Primary Power	7576	0x1D98	R/W	Value	Record Primary Power Value
				0	Do Not Record Primary Power
				1	Record Primary Power
Record Secondary Power	7577	0x1D99	R/W	Value	Record Secondary Power Value
				0	Do Not Record Secondary Power
				1	Record Secondary Power
Record Alarm 1 Status	7578	0x1D9A	R/W	Value	Record Change Of State For Alarm 1
				0	Do Not Record Alarm 1
				1	Record Alarm 1
Record Alarm 2 Status	7579	0x1D9B	R/W	Value	Record Change Of State For Alarm 2
				0	Do Not Record Alarm 2
				1	Record Alarm 2
Record Alarm 3 Status	7580	0x1D9C	R/W	Value	Record Change Of State For Alarm 3
				0	Do Not Record Alarm 3
				1	Record Alarm 3
Record Alarm 4 Status	7581	0x1D9D	R/W	Value	Record Change Of State For Alarm 4
				0	Do Not Record Alarm 4
				1	Record Alarm 4

Parameter Name	Modbus Address		Access	Values	
	(Dec)	(Hex)		Value	
Record Alarm 5 Status	7582	0x1D9E	R/W	Value	Record Change Of State For Alarm 5
				0	Do Not Record Alarm 5
				1	Record Alarm 5
Record Power	7583	0x1D9F	R/W	Value	Record Power Turned On/Off
				0	Do Not Record Power On/Off
				1	Record Power On/Off
Trigger Recording On Alarm 1	7584	0x1DA0	R/W	Value	Alarm 1 To Trigger Recording
				0	Off
				1	Trigger On Alarm 1 (if trigger is alarm)
Trigger Recording On Alarm 2	7685	0x1DA1	R/W	Value	Alarm 2 To Trigger Recording
				0	Off
				1	Trigger On Alarm 2 (if trigger is alarm)
Trigger Recording On Alarm 3	7686	0x1DA2	R/W	Value	Alarm 3 To Trigger Recording
				0	Off
				1	Trigger On Alarm 3 (if trigger is alarm)
Trigger Recording On Alarm 4	7687	0x1DA3	R/W	Value	Alarm 4 To Trigger Recording
				0	Off
				1	Trigger On Alarm 4 (if trigger is alarm)
Trigger Recording On Alarm 5	7688	0x1DA4	R/W	Value	Alarm 5 To Trigger Recording
				0	Off
				1	Trigger On Alarm 5 (if trigger is alarm)
Sample Size	7595	0x1DA5	RO	Size in bytes, for current setup of recording sample	
Record Event 1	7599	0x1DAF	R/W	Value	Record Change Of State For Event 1
				0	Do Not Record Event 1
				1	Record Event 1
Record Event 2	7600	0x1DB0	R/W	Value	Record Change Of State For Event 2
				0	Do Not Record Event 2
				1	Record Event 2
Record Event 3	7601	0x1DB1	R/W	Value	Record Change Of State For Event 3
				0	Do Not Record Event 3
				1	Record Event 3
Record Event 4	7602	0x1DB2	R/W	Value	Record Change Of State For Event 4
				0	Do Not Record Event 4
				1	Record Event 4
Record Event 5	7603	0x1DB3	R/W	Value	Record Change Of State For Event 5
				0	Do Not Record Event 5
				1	Record Event 5
Memory Used	7605	0x1DB5	RO	Recorder Memory Used. 0 (Empty) to 100% (Full)	
Date format	7868	0x1EBC	R/W	Value	Display Date Format
				0	dd/mm/yyyy (European Default)
				1	mm/dd/yyyy (USA Default)
Time	7869	0x1EBD	R/W	Format is the number of seconds since midnight.	
Date	7870	0x1EBE	R/W	Format 6 digits. Example 280308 for 28/03/2008	

Parameter Name	Modbus Address		Access	Values	
	(Dec)	(Hex)		Value	
Real Time Clock Fitted	7871	0x1EBF	RO	Value	Real Time Clock Fitted
				0	Not Fitted
				1	Fitted
Day Of The Week	7872	0x1EC0	R/W	Value	Day Of Week
				1	Monday
				2	Tuesday
				3	Wednesday
				4	Thursday
				5	Friday
				6	Saturday
				7	Sunday

Display Parameters

Parameter Name	Modbus Address		Access	Values	
	(Dec)	(Hex)		Value	
LED 1 Label	7660	0x1DEC	R/W	5 ASCII characters, which can be read or written using Modbus functions 16 or 23. Valid characters are 0 to 9, a to z, A to Z, plus () - and _. Defaults: 1 = PRI (Primary); 2 = SEC (Secondary); 3 = TUNE (Tuning); 4 = ALARM (Alarm)	
LED 2 Label	7661	0x1DED	R/W		
LED 3 Label	7662	0x1DEE	R/W		
LED 4 Label	7663	0x1DEF	R/W		
LED 1 Usage	7664	0x1DF0	R/W	Value	LED 1 Usage
				0	Primary Control
				1	Secondary Control
				2	Tuning
				3	Any Alarm
				4	Alarm 1
				5	Alarm 2
				6	Alarm 3
				7	Alarm 4
				8	Alarm 5
				9	Event 1
				10	Event 2
				11	Event 3
				12	Event 4
				13	Event 5
				14	Any Event
				15	Manual Control
				16	Profile Running
17	Profile Ended				
LED 2 Usage	7665	0x1DF1	R/W	Value	LED 2 Usage
				0	Primary Control
				1	Secondary Control
				2	Tuning
				3	Any Alarm
4	Alarm 1				

Parameter Name	Modbus Address		Access	Values	
	(Dec)	(Hex)			
				5	Alarm 2
				6	Alarm 3
				7	Alarm 4
				8	Alarm 5
				9	Event 1
				10	Event 2
				11	Event 3
				12	Event 4
				13	Event 5
				14	Any Event
				15	Manual Control
				16	Profile Running
				17	Profile Ended
				LED 3 Usage	7666
0	Primary Control				
1	Secondary Control				
2	Tuning				
3	Any Alarm				
4	Alarm 1				
5	Alarm 2				
6	Alarm 3				
7	Alarm 4				
8	Alarm 5				
9	Event 1				
10	Event 2				
11	Event 3				
12	Event 4				
13	Event 5				
14	Any Event				
15	Manual Control				
16	Profile Running				
17	Profile Ended				
LED 4 Usage	7667	0x1DF3	R/W	Value	LED 4 Usage
				0	Primary Control
				1	Secondary Control
				2	Tuning
				3	Any Alarm
				4	Alarm 1
				5	Alarm 2
				6	Alarm 3
				7	Alarm 4
				8	Alarm 5
				9	Event 1
				10	Event 2
11	Event 3				

Parameter Name	Modbus Address		Access	Values	
	(Dec)	(Hex)			
				12	Event 4
				13	Event 5
				14	Any Event
				15	Manual Control
				16	Profile Running
				17	Profile Ended
Backlight Colour	7668	0x1DF4	R/W	Value	Backlight Colour
				0	Green to Red on Alarm
				1	Red to Green on Alarm
				2	Permanent Green
				3	Permanent Red
Display Language	7675	0x1DFB	R/W	Value	Language
				0	Main Display Language
				1	Alternate Display Language
Display Contrast	7676	0x1DFC	R/W	0 to 127	
Invert Display	7677	0x1DFD	R/W	Value	Invert Display
				0	Normal Display
				1	Inverted Display
Setup Lock Code	7678	0x1DFE	R/W	1 to 9999. Default is 10	
Configuration Lock Code	7679	0x1DFF	R/W	1 to 9999. Default is 10	
Tuning Lock Code	7680	0x1E00	R/W	1 to 9999. Default is 10	
Supervisor Lock Code	7681	0x1E01	R/W	1 to 9999. Default is 10	
Profiler Lock Code	7682	0x1E02	R/W	1 to 9999. Default is 10	
USB Lock Code	7683	0x1E03	R/W	1 to 9999. Default is 10	
Recorder Lock Code	7684	0x1E04	R/W	1 to 9999. Default is 10	
Read Only Operation Mode	7685	0x1E05	R/W	Value	Read Only Operation Mode
				0	Operation Mode Read/Write
				1	Operation Mode Read Only
Bar Graph Format	7686	0x1E06	R/W	Value	Bar Graph Format
				0	Power Output
				1	Control Deviation
				2	% Memory Remaining
Trend View Sample Interval	9000	0x2328	R/W	Value	Trend Sample Interval
				0	Every Second
				1	Every 2 Seconds
				2	Every 5 Seconds
				3	Every 10 Seconds
				4	Every 15 Seconds
				5	Every 30 Seconds
				6	Every Minute
				7	Every 2 Minutes
				8	Every 5 Minutes
9	Every 10 Minutes				

Parameter Name	Modbus Address		Access	Values	
	(Dec)	(Hex)			
				10	Every 15 Minutes
				11	Every 30 Minutes
Values To Display In Trend View	9001	0x2329	R/W	Value	Trend View Data
				0	None (trend view off)
				1	Process variable only
				2	Process variable and setpoint
				3	Process variable maximum & minimum since last sample

Profiler Control & Status Parameters

Parameter Name	Modbus Address		Access	Values	
	(Dec)	(Hex)			
Profile Run/Hold Signal	8192	0x2000	R/W	Value	Profile Run/Hold Signal Source
				0	Operator Key Press Only
				1	Digital input A
Profile Abort Signal	8193	0x2001	R/W	Value	Profile Abort Signal Source
				0	Operator Key Press Only
				1	Digital input A
Active Profiler Number	8243	0x2033	R/W	Currently selected profile number (1 to 64)	
Active Segment Number	8244	0x2034	RO	Currently active segment (1 to 255)	
Profiler Control Commands	8245	0x2035	R/W	Value	Profiler Command
				0	Do nothing
				1	Run the currently selected profile
				2	Hold the currently running profile
				3	Abort the currently running profile
				4	Jump to the next segment
				5	Release the hold
6	Exit profiler, return to controller mode				
Note: The Profiler Control Commands <u>must</u> be followed by a Profiler Control Confirmation Action command.					
Profiler Control Confirmation Action	8257	0x2041	R/W	Value	Implement Profiler Command
				0	Do Not Implement Command
Enable Edit While Running	8262	0x2046	R/W	Value	Editing Current Running Profile
				0	Editing current running profile forbidden
Profile Control In Operation Mode	8260	0x2044	R/W	Value	Profile Control From Operation Mode
				0	Operation Mode profile control disabled
Profile Cycles Run	8247	0x2037	RO	1	Operation Mode profile control enabled
				The Number of times the currently running profile has cycled	

Parameter Name	Modbus Address		Access	Values	
	(Dec)	(Hex)		Value	Status
Event 1 Status	8249	0x2039	RO	Value	Status Of Event 1
				0	Event 1 Inactive
				1	Event 1 Active
Event 2 Status	8250	0x203A	RO	Value	Status Of Event 2
				0	Event 2 Inactive
				1	Event 2 Active
Event 3 Status	8251	0x203B	RO	Value	Status Of Event 3
				0	Event 3 Inactive
				1	Event 3 Active
Event 4 Status	8252	0x203C	RO	Value	Status Of Event 4
				0	Event 4 Inactive
				1	Event 4 Active
Event 5 Status	8253	0x203D	RO	Value	Status Of Event 5
				0	Event 5 Inactive
				1	Event 5 Active
Segment Type Status	8258	0x2042	RO	Value	Segment Type Status
				0	No segment
				1	Setpoint ramping up
				2	Step
				3	Dwell
				4	Held
				5	Loop
				6	Join
				7	End
8	Setpoint ramping down				
Currently Active Profile Name	8259	0x2043	RO	The name of the currently selected profile	
Secondary Profile Status	8232	0x2028	RO	Value	
				0	Profile running
				1	Input sensor break
				2	Profile not valid
				3	Controller in manual mode
				4	Profile finished. Profiler is maintaining the last profile setpoint
				5	Profile finished with control outputs off
6	Profile control has ended. Unit is Controller Mode.				
Delay time	8233	0x2029	RO	The current start delay time remaining	
Current Profile Running Time	8235	0x202B	RO	The elapsed time of the current running profile	
Current Profile Remaining Time	8236	0x202C	RO	The remaining time for the current running profile	
Current Segment Running Time	8237	0x202D	RO	The elapsed time of the current profile segment	

Parameter Name	Modbus Address		Access	Values
	(Dec)	(Hex)		
Current Segment Remaining Time	8238	0x202E	RO	The remaining time for the current profile segment
Total Hold Time	8239	0x202F	RO	Total time the current profile has been held
Current Segment Loops Run	8240	0x2030	RO	The number of times the current looping segment has looped back
Profile Setup	8198	0x2006	R/W	Refer to the Profile Setup Over Modbus information below

Profile Setup Via Modbus

The information in this section is intended for advanced users writing their own software code. Most users will create or edit profiles using the instrument keypad, or using the the PC software (available from your supplier). Either method allows quick and easy editing of profiles.

Advanced users can setup or edit profiles by writing to the Profile Configuration parameter at address 8198 (0x2006). This can only be accessed by using Modbus function code 23 (0x17). The instrument replies with a status message.

When creating a new profile the steps below must be followed exactly, either to create a profile at the next available position, or at a position that you specify.

Each message in the sequence includes a 2 byte Command Code that tells the instrument the purpose of the message, and therefore the meaning of the data contained in it.

Instruction Sequence to create a profile at the next available position

1. Create a profile by writing the profile header data using the Command Code value CP (0x43, 0x50). This starts the profile creation process by reserving a profile memory slot. The profile number is returned by the instrument in the Edit Response Message.
2. Write the first segment using the Command Code value Code WS (0x57, 0x53). This command will fill the next available segment position and link it to the profile created in step 1.
3. Write the second segment, again using Command Code WS. This fills the next available segment position and links it to the segment created in step 2.
4. Continue writing segments until the profile is complete (whilst remaining within the overall limit of 255 segments for all profiles combined). Each of these segments fills the next available position and links it to the previous segment specified.
5. The very last segment of the profile must be one of the end type segments. Thereafter, no more segments can be added to the specified profile. To add a segment to an existing profile the insert segment command must be used.

Instruction Sequence to create a profile at a specified profile position

CAUTION:

If this profile number is already in use then the profile header data is overwritten but the segments associated with it are kept.

1. Determine which profile positions are being used by using the Command Code value PS (0x50, 0x53). This command will return a list of all the profile positions currently being used.
2. Choose a location that is not being used and write the profile header data using the Command Code value WP (0x57, 0x50).
The profile number is echoed back by the instrument in the Edit Response Message.
3. Write the first segment using the Command Code value Code WS (0x57, 0x53). This command will fill the next available segment position and link it to the profile created in step 1.
4. Write the second segment, again using Command Code WS. This fills the next available segment position and links it to the segment created in step 2.
5. Continue writing segments until the profile is complete (whilst remaining within the overall limit of 255 segments for all profiles combined). Each of these segments fills the next available position and links it to the previous segment specified.
6. The very last segment of the profile must be one of the end type segments. Thereafter, no more segments can be added to the specified profile. To add a segment to an existing profile the insert segment command must be used.

Instruction Sequence to edit an existing Profile Header

When a profile header is changed, the segments associated with it remain unchanged. They must be edited separately if required.

1. Determine the number of the profile to be edited. Use the Command Code value PS (0x50, 0x53) which returns a list of all profile positions/numbers currently in use.
2. Write a new profile header data using the Command Code value EP (0x45, 0x50).
The profile number is echoed back by the instrument in the Edit Response Message.

Instruction Sequence to read a profile

1. Use the command RP to read the profile header data
2. Use the command RS to read the 1st segment's data
3. Use the command RS to read the 2nd segment's data.
4. Repeat steps 2 and 3 until an end segment is reached.

The following rules apply when creating a profile over communications:

- Profiles must always be terminated with an end segment.
- Segments cannot be added after an end segment has been added.
- All changes made to the selected profile are immediately saved in the instrument.

Creating Or Editing A Profile Header

Creating Or Editing A Profile Header - Request (to instrument)			
Field Name	Data		Comments
	(Dec)	(Hex)	
Unit Address	A/R	A/R	The ID address of the instrument.
Function Code	23	17	Requires the multi read/write function.
Read Start Address High Byte	32	20	
Read Start Address Low Byte	06	06	
Read Quantity Of Registers High Byte	00	00	
Read Quantity Of Registers Low Byte	01	01	
Write Start Address High Byte	32	20	
Write Start Address Low Byte	06	06	
Write Quantity Of Registers High Byte	00	00	
Write Quantity Of Registers Low Byte	19	13	
Byte Count	38 or 40	26 or 28	38dec / 0x26hex if creating a profile at the next available location. 40dec / 0x28hex if creating a profile at a specified location, or editing a profile.
Command Code High Byte	67, 69 or 87	43, 45 or 57	Create Profile (CP) = 67dec / 0x43hex Edit Profile (EP) = 69dec / 0x45hex Write Profile (WP) = 87dec / 0x57hex
Command Code Low Byte	80	50	
Profile Number High Byte	A/R	A/R	Note: The profile number is not included in the message when creating a profile at the next available position.
Profile Number Low Byte	A/R	A/R	
Profile Name Character 1	A/R	A/R	The ASCII codes equivalent to each of the 16 characters of the profile name, e.g. : A = 65dec / 0x41, B = 66dec / 0x42 etc a = 97dec / 0x61, b = 98dec / 0x62 etc Note: Only valid characters from the instruments supported character set should be used The space character (32dec / 0x20hex) is used to fill any unused characters at the end of the name.
Profile Name Character 2	A/R	A/R	
Profile Name Character 3	A/R	A/R	
Profile Name Character 4	A/R	A/R	
Profile Name Character 5	A/R	A/R	
Profile Name Character 6	A/R	A/R	
Profile Name Character 7	A/R	A/R	
Profile Name Character 8	A/R	A/R	
Profile Name Character 9	A/R	A/R	
Profile Name Character 10	A/R	A/R	
Profile Name Character 11	A/R	A/R	
Profile Name Character 12	A/R	A/R	
Profile Name Character 13	A/R	A/R	
Profile Name Character 14	A/R	A/R	
Profile Name Character 15	A/R	A/R	
Profile Name Character 16	A/R	A/R	
Profile Start Signal High Byte	00	00	0 = No delay, 1 = After delay, 2 = At

Creating Or Editing A Profile Header - Request (to instrument)			
Field Name	Data		Comments
	(Dec)	(Hex)	
Profile Start Signal Low Byte	A/R	A/R	Time/day
Profile Start Time (Byte 4 - High)	Floating point number		
Profile Start Time (Byte 3)			
Profile Start Time (Byte 2)			
Profile Start Time (Byte 1 - Low)			
Profile Start Day High Byte	00	00	1 = Monday, 2 = Tuesday, 3 = Wednesday, 4 = Thursday, 5 = Friday, 6 = Saturday, 7 = Sunday, 8 = Monday to Friday, 9 = Monday to Saturday, 10 = Saturday And Sunday, 11= All Week
Profile Start Day Low Byte	A/R	A/R	
Profile Starting Setpoint High	00	00	0 = Current Setpoint, 1 = Current Process Variable Value
Profile Starting Setpoint Low	A/R	A/R	
Profile Recovery High Byte	00	00	0 = Control to off, 1 = Restart profile, 2 = Maintain last profile setpoint 3 = Use controller setpoint, 4 = Continue profile from where it was when power failed
Profile Recovery Low Byte	A/R	A/R	
Profile Recovery Time (Byte 4 - high)	Floating point number		
Profile Recovery Time (Byte 3)			
Profile Recovery Time (Byte 2)			
Profile Recovery Time (Byte 1 - Low)			
Profile Abort action High Byte	00	00	0 = Control to off 1 = Maintain last profile setpoint 2 = Use controller setpoint
Profile Abort Action Low Byte	A/R	A/R	
Profile Cycles High Byte	A/R	A/R	1 to 9999 or 10,000 for "Infinite"
Profile Cycles Low Byte	A/R	A/R	
CRC High Byte	A/R	A/R	
CRC Low Byte	A/R	A/R	

The instrument replies to this message with an Edit Response Message.

Creating, Editing or Inserting Segments

Creating new segments is only possible when a new profile is being created (see above for instruction for creating a profile at the next available position, or at a position that you specify). An error is returned if the correct sequence is not followed.

The Insert Segment command is used to add segments to an existing profile (one that already has an end segment). This inserts a new segment at the position specified.

The Edit Segment command is used to alter segments of an existing profile.

The segment number is in relation to the profile number, e.g. to edit or insert a segment at position 3 of profile 1 the segment number will be 3, and to edit or insert a segment at position 3 of profile 6 the segment number will also be 3.

Creating, Editing or Inserting Segments - Request (to instrument)			
Field Name	Data		Comments
	(Dec)	(Hex)	
Unit Address	A/R	A/R	The ID address of the instrument.
Function Code	23	17	Requires the multi read/write function.
Read Start Address High Byte	32	20	
Read Start Address Low Byte	06	06	

Creating, Editing or Inserting Segments - Request (to instrument)			
Field Name	Data		Comments
	(Dec)	(Hex)	
Read Quantity Of Registers High	00	00	
Read Quantity Of Registers Low	01	01	
Write Start Address High	32	20	
Write Start Address Low	06	06	
Write Quantity Of Registers High	00	00	
Write Quantity Of Registers Low	11 or 12	0B or 0C	Create Segment (WS) = 11dec / 0x0Bhex Insert Segment (IS) = 12dec / 0x0Chex Edit A Segment (ES) = 12dec / 0x0Chex
Byte Count	22 or 24	16 or 18	Create Segment (WS) = 22dec / 0x16hex Insert Segment (IS) = 24dec / 0x18hex Edit A Segment (ES) = 24dec / 0x18hex
Command Code High Byte	87, 73 or 69	57 or 49	Create Segment (WS) = 87dec / 0x57hex Insert Segment (IS) = 73dec / 0x49hex Edit A Segment (ES) = 69dec / 0x45hex
Command Code Low Byte	83	53	
Profile Number High Byte	A/R	A/R	
Profile Number Low Byte	A/R	A/R	
Segment Position High Byte	A/R	A/R	Note: The Segment Position is not included in the message when creating a segment at the next available position.
Segment Position Low Byte	A/R	A/R	
Segment Type High Byte	00	00	0 = Ramp Time, 1 = Ramp Rate, 2 = Step, 3 = Dwell, 4 = Hold, 5 = Loop 6 = Join, 7 = End, 8 = Repeat sequence then end
Segment Type Low Byte	A/R	A/R	
Segment Info A (Byte 4 - High)	Floating point number		The meaning of the data contained in Segment Info A depends on the type of segment it relates to. See below.
Segment Info A (Byte 3)			
Segment Info A (Byte 2)			
Segment Info A (Byte 1 - Low)			
Segment Info B (Byte 4 - High)	Floating point number		The meaning of the data contained in Segment Info B depends on the type of segment it relates to. See below.
Segment Info B (Byte 3)			
Segment Info B (Byte 2)			
Segment Info B (Byte 1 - Low)			
Auto Hold Type High Byte	A/R	A/R	0 = Auto-Hold Off, 1 = Hold above SP, 2 = Hold below SP, 3 - Hold above and below SP
Auto Hold Type Low Byte	A/R	A/R	
Auto Hold Value (Byte 4 - High)	Floating point number		
Auto Hold Value (Byte 3)			
Auto Hold Value (Byte 2)			
Auto Hold Value (Byte 1 - Low)			
Events High Byte	00	00	The status of the five events are defined by the lowest 5 bits of the low byte. A bit value of 1 signifies the event is on. Bit 0 = event 1, bit 1 = event 2, bit 3 = event 4 and bit 5 = event 4.
Events Low Byte	A/R	A/R	
CRC High Byte	A/R	A/R	
CRC Low Byte	A/R	A/R	

Segment Data

The Segment Data is included in the command message when creating, editing or inserting segments (see above). It is provided in two parts (Segment Info A and B).

The meaning of the data contained in Segment Info A and B depends on the type of segment it relates to. *Null* is shown for unused data, these data values should be set to zero when writing the segment data.

Segment Type	Segment Info		Description
	A	B	
Ramp Time	Time	Target setpoint	Ramp to the target setpoint "B" in the time "A"
Ramp Rate	Ramp rate	Target setpoint	Ramp to the target setpoint "B" at the ramp rate "A"
Step	<i>Null</i>	Target setpoint	Step to a target setpoint "B"
Dwell	Dwell time	<i>Null</i>	Stay at the current setpoint for a period of time "A"
Hold	0 = Operator	<i>Null</i>	Wait for the operator to release the hold
	1 = Time of day	Start Time	Wait until time of the day "B" in seconds since midnight. (<i>recorder only</i>).
	2 = Aux A digital input	<i>Null</i>	Wait for digital input A signal
	3 = Aux B digital input	<i>Null</i>	Wait for digital input B signal
Loop	Number of times to repeat 1 to 9999	Segment number	Loop to the specified segment number "B" from this point. Repeat this "A" times. Only segments below the current segment can be entered. Two loops must not cross each other.
Join	<i>Null</i>	Profile number	On completion of this profile jump run profile "B"
End	0 = Control off	<i>Null</i>	Turn off all control outputs.
	1 = Maintain profile setpoint	<i>Null</i>	Stay at the final setpoint of the profile
	2 = Use controller setpoint	<i>Null</i>	Use the active controller setpoint.
Repeat Sequence Then End	0 = Outputs off	Number of times to repeat sequence	Repeat the profile sequence number "B" times, then turn off the control outputs
	1 = Maintain profile setpoint		Repeat the profile sequence number "B" times, then hold the last profile setpoint.
	2 = Use controller setpoint		Repeat the profile sequence number "B" times, then use the active controller setpoint.

The instrument replies to this message with an Edit Response Message.

Deleting Profiles

An individual profile can be deleted, or all profiles can be cleared with a single message. Deleting a profile removes the header of the specified profile and any segments associated with it. Delete all profiles wipes all profiles and segments from the instrument.

Delete Profiles - Request (to instrument)			
Field Name	Data		Comments
	(Dec)	(Hex)	
Unit Address	A/R	A/R	The ID address of the instrument.
Function Code	23	17	Requires the multi read/write function
Read Start Address High Byte	32	20	
Read Start Address Low Byte	06	06	
Read Quantity Of Registers High	00	00	
Read Quantity Of Registers Low	01	01	

Delete Profiles - Request (to instrument)			
Field Name	Data		Comments
	(Dec)	(Hex)	
Write Start Address High	32	20	
Write Start Address Low	06	06	
Write Quantity Of Registers High	00	00	
Write Quantity Of Registers Low	02 or 01	02 or 01	Delete A Profile (DP) = 02dec / 0x02hex Delete All Profiles (DA) = 01dec / 0x01hex
Byte Count	04 or 02	04 or 02	Delete A Profile (DP) = 04dec / 0x04hex Delete All Profiles (DA) = 02dec / 0x02hex
Command Code High Byte	68	44	
Command Code Low Byte	80 or 65	50 or 41	Delete A Profile (DP) = 80dec / 0x50hex Delete All Profiles (DA) = 65dec / 0x41hex
Profile Number High Byte	A/R	A/R	Note: The profile number is not included in the message when deleting all profiles.
Profile Number Low Byte	A/R	A/R	
CRC High Byte	A/R	A/R	
CRC Low Byte	A/R	A/R	

The instrument replies to this message with an Edit Response Message.

Delete A Segment

The delete segment command deletes the specified segment from the specified profile. The following segments are moved up one place in the profile (e.g. if segment 6 is deleted segment 7 now becomes segment 6).

Delete A Segment - Request (to instrument)			
Field Name	Data		Comments
	(Dec)	(Hex)	
Unit Address	A/R	A/R	The ID address of the instrument
Function Code	23	17	Requires the multi read/write function
Read Start Address High Byte	32	20	
Read Start Address Low Byte	06	06	
Read Quantity Of Registers High	00	00	
Read Quantity Of Registers Low	01	01	
Write Start Address High	32	20	
Write Start Address Low	06	06	
Write Quantity Of Registers High	00	00	
Write Quantity Of Registers Low	03	03	
Byte Count	06	06	
Command Code High Byte	68	44	
Command Code Low Byte	83	53	
Profile Number High Byte	A/R	A/R	
Profile Number Low Byte	A/R	A/R	
Segment Number High Byte	A/R	A/R	
Segment Number Low Byte	A/R	A/R	
CRC High Byte	A/R	A/R	
CRC Low Byte	A/R	A/R	

The instrument replies to this message with an Edit Response Message.

Get Segments Remaining

Returns the number of unused segments remaining in the instrument. The number will be between 0 and 255, depending on how many have been used in the profiles so far created.

Get Segments Remaining - Request (to instrument)			
Field Name	Data		Comments
	(Dec)	(Hex)	
Unit Address	A/R	A/R	The ID address of the instrument as required
Function Code	23	17	Requires the multi read/write function
Read Start Address High Byte	32	20	
Read Start Address Low Byte	06	06	
Read Quantity Of Registers High	00	00	
Read Quantity Of Registers Low	01	01	
Write Start Address High	32	20	
Write Start Address Low	06	06	
Write Quantity Of Registers High	00	00	
Write Quantity Of Registers Low	01	01	
Byte Count	02	02	
Command Code High Byte	83	53	
Command Code Low Byte	82	52	
CRC High Byte	A/R	A/R	
CRC Low Byte	A/R	A/R	

The instrument replies to this message with an Edit Response Message.

Edit Response Message From Instrument

The instrument replies to each profile or segment creation, edit or delete message with an Edit Response Message. The same format is used when replying to the Get Segments Remaining request.

Edit Response Message - Response (from instrument)			
Field Name	Data		Comments
	(Dec)	(Hex)	
Unit Address	A/R	A/R	The ID address of the instrument
Function Code	23	17	The multi read/write function
Byte Count	02	02	
Command Response High Byte	A/R	A/R	<i>Two data bytes containing the Command Response data (see below)</i>
Command Response Low Byte	A/R	A/R	
CRC High Byte	A/R	A/R	
CRC Low Byte	A/R	A/R	

Command Response Data

The data contained in the Edit Response Message returned after each profile or segment edit message is shown below. The data seen can be an error code, the number of unused segments or the profile number following a successful profile header creation/edit. The error code shown will be as appropriate for the request message and instrument status.

Command Response Name	Two Byte Response		Description
	Low Byte	High Byte	
Profile Number	A/R	A/R	The number of the profile created or edited
Segments Remaining	A/R	A/R	The number of unused segments remaining
Command Successfully	0x4F	0x4B	The command requested executed without error
Command Not Recognized	0xFF	0xFF	The command is not recognized
Profile Number Invalid	0xF0	0x00	The profile number specified is not available.
Profile Name Invalid	0xF0	0x01	The profile name/characters are not valid
Start Signal Invalid	0xF0	0x02	The start signal is not recognized
Start Time Invalid	0xF0	0x03	The specified time is not within range
Start Day Invalid	0xF0	0x04	The specified day is not recognized
Starting Setpoint Invalid	0xF0	0x05	The specified starting setpoint is not recognized
Profile Recovery Invalid	0xF0	0x06	The profile recovery is not recognized
Recovery Time Invalid	0xF0	0x07	The recovery time is not within limits
Abort Action Invalid	0xF0	0x08	The abort action is not recognized
Profile Cycles Invalid	0xF0	0x09	The number of profile cycles is not within limits
Segment Number Invalid	0xF0	0x0A	The segment number is not valid for this profile
Segment Type Invalid	0xF0	0x0B	The segment type is not recognized
Segment Info A Invalid	0xF0	0x0C	The segment information A not valid for segment type defined
Segment Info B Invalid	0xF0	0x0D	The segment information B is not valid for the segment type defined
Auto Hold Type Invalid	0xF0	0x0E	The auto hold type is not recognized
Auto Hold Value Invalid	0xF0	0x0F	The auto hold value is not within input span
Events Value Invalid	0xF0	0x10	The events are not within range
No Segments Remaining	0xF0	0x11	There are no more segments available
Write Length Invalid	0xF0	0x12	The number of parameters to be written are invalid for the function requested
Segment Setpoint Clamped	0xF0	0x13	The setpoint value entered was out of bounds. It has been clamped within the units setpoint limits.

Read A Profile Header

Read A Profile Header - Request (to instrument)			
Field Name	Data		Comments
	(Dec)	(Hex)	
Unit Address	A/R	A/R	The ID address of the instrument
Function Code	23	17	Requires the multi read/write function
Read Start Address High Byte	32	20	
Read Start Address Low Byte	06	06	
Read Quantity Of Registers High Byte	00	00	
Read Quantity Of Registers Low Byte	18	12	
Write Start Address High Byte	32	20	
Write Start Address Low Byte	06	06	

Read A Profile Header - Request (to instrument)			
Field Name	Data		Comments
	(Dec)	(Hex)	
Write Quantity Of Registers High Byte	00	00	
Write Quantity Of Registers Low Byte	02	02	
Byte Count	04	04	
Command Code High Byte	82	52	
Command Code Low Byte	80	50	
Profile Number High Byte	A/R	A/R	
Profile Number Low Byte	A/R	A/R	
CRC High Byte	A/R	A/R	
CRC Low Byte	A/R	A/R	

The instrument replies to the Read A Profile Header request as follows:

Read Profile Header - Response (from instrument)			
Field Name	Data		Comments
	(Dec)	(Hex)	
Unit Address	A/R	A/R	The ID address of the instrument
Function Code	23	17	The multi read/write function
Byte Count	36	24	
Profile Name Character 1	A/R	A/R	The ASCII codes equivalent to each of the 16 characters of the profile name, e.g. : A = 65dec / 0x41, B = 66dec / 0x42 etc a = 97dec / 0x61, b = 98dec / 0x62 The space character (32dec / 0x20hex) is used to fill any unused characters at the end of the name.
Profile Name Character 2	A/R	A/R	
Profile Name Character 3	A/R	A/R	
Profile Name Character 4	A/R	A/R	
Profile Name Character 5	A/R	A/R	
Profile Name Character 6	A/R	A/R	
Profile Name Character 7	A/R	A/R	
Profile Name Character 8	A/R	A/R	
Profile Name Character 9	A/R	A/R	
Profile Name Character 10	A/R	A/R	
Profile Name Character 11	A/R	A/R	
Profile Name Character 12	A/R	A/R	
Profile Name Character 13	A/R	A/R	
Profile Name Character 14	A/R	A/R	
Profile Name Character 15	A/R	A/R	
Profile Name Character 16	A/R	A/R	
Profile Start Signal High Byte	00	00	0 = No delay, 1 = After delay, 2 = At Time/day
Profile Start Signal Low Byte	A/R	A/R	
Profile Start Time (Byte 4 - High)	Floating point number		
Profile Start Time (Byte 3)			
Profile Start Time (Byte 2)			
Profile Start Time (Byte 1 - Low)			
Profile Start Day High Byte	00	00	1 = Monday, 2 = Tuesday, 3 = Wednesday, 4 = Thursday, 5 = Friday, 6 = Saturday, 7 = Sunday, 8 = Monday to Friday, 9 = Monday to Saturday, 10 = Saturday And Sunday, 11= All Week
Profile Start Day Low Byte	A/R	A/R	

Read Profile Header - Response (from instrument)			
Field Name	Data		Comments
	(Dec)	(Hex)	
Profile Starting Setpoint High	00	00	0 = Current Setpoint, 1 = Current Process Variable Value
Profile Starting Setpoint Low	A/R	A/R	
Profile Recovery High Byte	00	00	0 = Control to off, 1 = Restart profile, 2 = Maintain last profile setpoint 3 = Use controller setpoint, 4 = Continue profile from where it was when power failed
Profile Recovery Low Byte	A/R	A/R	
Profile Recovery Time (Byte 4 - high)	Floating point number		
Profile Recovery Time (Byte 3)			
Profile Recovery Time (Byte 2)			
Profile Recovery Time (Byte 1 - Low)			
Profile Abort action High Byte	00	00	0 = Control to off 1 = Maintain last profile setpoint 2 = Use controller setpoint
Profile Abort Action Low Byte	A/R	A/R	
Profile Cycles High Byte	A/R	A/R	1 to 9999 or 10,000 for "Infinite"
Profile Cycles Low Byte	A/R	A/R	
CRC High Byte	A/R	A/R	
CRC Low Byte	A/R	A/R	

Read A Segment

Read A Segment - Request (to instrument)			
Field Name	Data		Comments
	(Dec)	(Hex)	
Unit Address	A/R	A/R	The ID address of the instrument
Function Code	23	17	Requires the multi read/write function
Read Start Address High Byte	32	20	
Read Start Address Low Byte	06	06	
Read Quantity Of Registers High Byte	00	00	
Read Quantity Of Registers Low Byte	11	0B	
Write Start Address High Byte	22	16	
Write Start Address Low Byte	06	06	
Write Quantity Of Registers High Byte	00	00	
Write Quantity Of Registers Low Byte	03	03	
Byte Count	06	06	
Command Code High Byte	82	52	
Command Code Low Byte	83	53	
Profile Number High Byte	A/R	A/R	
Profile Number Low Byte	A/R	A/R	
Segment Number High Byte	A/R	A/R	
Segment Number Low Byte	A/R	A/R	
CRC High Byte	A/R	A/R	
CRC Low Byte	A/R	A/R	

The instrument replies to the Read A Segment request as follows:

Read A Segment - Response (from instrument)			
Field Name	Data		Comments
	(Dec)	(Hex)	
Unit Address	A/R	A/R	The ID address of the instrument
Function Code	23	17	The multi read/write function
Byte Count	02	18	
Command Response High Byte	82	52	
Command Response Low Byte	83	53	
Profile Number High Byte	A/R	A/R	
Profile Number Low Byte	A/R	A/R	
Segment Number High Byte	A/R	A/R	
Segment Number Low Byte	A/R	A/R	
Segment Type High Byte	00	00	0 = Ramp Time, 1 = Ramp Rate, 2 = Step, 3 = Dwell, 4 = Hold, 5 = Loop 6 = Join, 7 = End, 8 = Repeat sequence then end
Segment Type Low Byte	A/R	A/R	
Segment Info A (Byte 4 - High)	Floating point number		The meaning of the data contained in Segment Info A depends on the type of segment it relates to. See below.
Segment Info A (Byte 3)			
Segment Info A (Byte 2)			
Segment Info A (Byte 1 - Low)			
Segment Info B (Byte 4 - High)	Floating point number		The meaning of the data contained in Segment Info B depends on the type of segment it relates to. See below.
Segment Info B (Byte 3)			
Segment Info B (Byte 2)			
Segment Info B (Byte 1 - Low)			
Auto Hold Type High Byte	A/R	A/R	0 = Auto-Hold Off, 1 = Hold above SP, 2 = Hold below SP, 3 - Hold above and below SP
Auto Hold Type Low Byte	A/R	A/R	
Auto Hold Value (Byte 4 - High)	Floating point number		
Auto Hold Value (Byte 3)			
Auto Hold Value (Byte 2)			
Auto Hold Value (Byte 1 - Low)			
Events High Byte	00	00	The status of the five events are defined by the lowest 5 bits of the low byte. A bit value of 1 signifies the event is on. Bit 0 = event 1, bit 1 = event 2, bit 3 = event 4 and bit 5 = event 4.
Events Low Byte	A/R	A/R	
CRC High Byte	A/R	A/R	
CRC Low Byte	A/R	A/R	

Segment Data

The Segment Data is included in the response to a Read Segment request. It is provided in two parts (Segment Info A and B).

The meaning of the data contained in Segment Info A and B depends on the type of segment it relates to. *Null* is shown for unused data, this can be any value.

Segment Type	Segment Info		Description
	A	B	
Ramp Time	Time	Target setpoint	Ramp to the target setpoint "B" in the time "A"
Ramp Rate	Ramp rate	Target setpoint	Ramp to the target setpoint "B" at the ramp rate "A"
Step	<i>Null</i>	Target setpoint	Step to a target setpoint "B"
Dwell	Dwell time	<i>Null</i>	Stay at the current setpoint for a period of time "A"
Hold	0 = Operator	<i>Null</i>	Wait for the operator to release the hold
	1 = Time of day	Start Time	Wait until time of the day "B" in seconds since midnight. (<i>recorder only</i>).
	2 = Aux A digital input	<i>Null</i>	Wait for digital input A signal
	3 = Aux B digital input	<i>Null</i>	Wait for digital input B signal
Loop	Number of times to repeat 1 to 9999	Segment number	Loop to the specified segment number "B" from this point. Repeat this "A" times. Only segments below the current segment can be entered. Two loops must not cross each other.
Join	<i>Null</i>	Profile number	On completion of this profile jump run profile "B"
End	0 = Control off	<i>Null</i>	Turn off all control outputs.
	1 = Maintain profile setpoint	<i>Null</i>	Stay at the final setpoint of the profile
	2 = Use controller setpoint	<i>Null</i>	Use the active controller setpoint.
Repeat Sequence Then End	0 = Outputs off	Number of times to repeat sequence	Repeat the profile sequence number "B" times, then turn off the control outputs
	1 = Maintain profile setpoint		Repeat the profile sequence number "B" times, then hold the last profile setpoint.
	2 = Use controller setpoint		Repeat the profile sequence number "B" times, then use the active controller setpoint.

Read Profile Name

This command returns the name of the profile defined by the profile number requested.

Read Profile Name - Request (to instrument)			
Field Name	Data		Comments
	(Dec)	(Hex)	
Unit Address	A/R	A/R	The ID address of the instrument
Function Code	23	17	Requires the multi read/write function
Read Start Address High Byte	32	20	
Read Start Address Low Byte	06	06	
Read Quantity Of Registers High Byte	00	00	
Read Quantity Of Registers Low Byte	08	08	
Write Start Address High Byte	32	20	
Write Start Address Low Byte	06	06	

Read Profile Name - Request (to instrument)			
Field Name	Data		Comments
	(Dec)	(Hex)	
Write Quantity Of Registers High Byte	00	00	
Write Quantity Of Registers Low Byte	02	02	
Byte Count	04	04	
Command Code High Byte	80	50	
Command Code Low Byte	78	4E	
Profile Number High Byte	A/R	A/R	
Profile Number Low Byte	A/R	A/R	
CRC High Byte	A/R	A/R	
CRC Low Byte	A/R	A/R	

The instrument replies to the Read Profile Name request as follows:

Read Profile Name - Response (from instrument)			
Field Name	Data		Comments
	(Dec)	(Hex)	
Unit Address	A/R	A/R	The ID address of the instrument
Function Code	23	17	The multi read/write function
Byte Count	16	10	
Profile Name Character 1	A/R	A/R	The ASCII codes equivalent to each of the 16 characters of the profile name, e.g. : A = 65dec / 0x41, B = 66dec / 0x42 etc a = 97dec / 0x61, b = 98dec / 0x62 The space character (32dec / 0x20hex) is used to fill any unused characters at the end of the name.
Profile Name Character 2	A/R	A/R	
Profile Name Character 3	A/R	A/R	
Profile Name Character 4	A/R	A/R	
Profile Name Character 5	A/R	A/R	
Profile Name Character 6	A/R	A/R	
Profile Name Character 7	A/R	A/R	
Profile Name Character 8	A/R	A/R	
Profile Name Character 9	A/R	A/R	
Profile Name Character 10	A/R	A/R	
Profile Name Character 11	A/R	A/R	
Profile Name Character 12	A/R	A/R	
Profile Name Character 13	A/R	A/R	
Profile Name Character 14	A/R	A/R	
Profile Name Character 15	A/R	A/R	
Profile Name Character 16	A/R	A/R	
CRC High Byte	A/R	A/R	
CRC Low Byte	A/R	A/R	

Read Profile Memory Status

This command returns the status of the profile memory used. The response to this command is to return a table of all the profile numbers that are in use. A value of 0x00 indicates that the profile position is free and value of 0x01 indicates that the position is used by a profile. Using this command in conjunction with the read profile name command will give a directory of profile numbers to profile names.

Read Profile Memory Status - Request (to instrument)			
Field Name	Data		Comments
	(Dec)	(Hex)	
Unit Address	A/R	A/R	The ID address of the instrument
Function Code	23	17	Requires the multi read/write function
Read Start Address High Byte	32	20	
Read Start Address Low Byte	06	06	
Read Quantity Of Registers High Byte	00	00	
Read Quantity Of Registers Low Byte	32	20	
Write Start Address High Byte	32	20	
Write Start Address Low Byte	06	06	
Write Quantity Of Registers High Byte	00	00	
Write Quantity Of Registers Low Byte	02	02	
Byte Count	04	04	
Command Code High Byte	80	50	
Command Code Low Byte	83	53	
Profile Number High Byte	A/R	A/R	
Profile Number Low Byte	A/R	A/R	
CRC High Byte	A/R	A/R	
CRC Low Byte	A/R	A/R	

Read Profile Status

The instrument replies to the Read Profile Memory Status request as follows:

Read Profile Memory Status - Response (from instrument)			
Field Name	Data		Comments
	(Dec)	(Hex)	
Unit Address	A/R	A/R	The ID address of the instrument
Function Code	23	17	The multi read/write function
Byte Count	64	40	
Profile 1 Position	0 or 1	0 or 1	For each of the 64 possible profile positions, a value of 0 is returned if the position is free, or 1 if the position is empty.
Profile 2 Position	0 or 1	0 or 1	
<i>etc.....</i>			
Profile 63 Position	0 or 1	0 or 1	
Profile 64 Position	0 or 1	0 or 1	
CRC High Byte	A/R	A/R	
CRC Low Byte	A/R	A/R	

Instrument Data

Parameter Name	Modbus Address		Access	Values	
	(Dec)	(Hex)			
Serial Number 1	210	0x00D2	RO	The first 4 digits of the instrument's Serial number.	
Serial Number 2	211	0x00D3	RO	The digits 5 to 8 of the instrument's Serial number.	
Serial Number 3	212	0x00D4	RO	The digits 9 to 11 of the instrument's Serial number.	
Serial Number 4	213	0x00D5	RO	The digits 12 to 14 of the instrument's Serial number.	
Manufacture Day	370	0x0172	RO	Date of manufacture – 1 to 31 (day of month)	
Manufacture Month	371	0x0173	RO	Month of manufacture – 1 to 12	
Manufacture Year	372	0x0174	RO	4 digit number = Year of manufacture (e.g. 2008)	
USB Option Fitted	7503	0x1D4F	RO	Value	USB Option
				0	Not Fitted
				1	Fitted
Data Recorder Fitted	7868	0x1EBC	RO	Value	Data Recorder Fitted
				0	Not Fitted
				1	Fitted
Profiler Enabled	8199	0x2007	RO	Value	Profiler Enabled
				0	Profiler Not Enabled
				1	Profiler Enabled
Software PRL	208	0x00D0	RO	Product Revision Level – Firmware Level	
Hardware PRL	207	0x00CF	RO	Product Revision Level – Hardware Level	
Firmware Type	217	0x00D9	RO	Firmware major version number	
Firmware Version	218	0x00DA	RO	Firmware minor version number	
Contact Details 1	400	0x0190	R/W	7 lines of user definable text - 25 ASCII characters per line which can be read or written using Modbus functions 16 or 23. Valid characters are 0 to 9, a to z, A to Z, plus () - and _. Example. To write "My Company Name" to line 1 send: [ADDRESS], 16, 01, 90, 00, 08, 10, 4D, 79, 20, 43, 6F, 6D, 70, 61, 6E, 79, 20, 4E, 61, 6D, 65, [CRC]	
Contact Details 2	401	0x0191	R/W		
Contact Details 3	402	0x0192	R/W		
Contact Details 4	403	0x0193	R/W		
Contact Details 5	404	0x0194	R/W		
Contact Details 6	405	0x0195	R/W		
Contact Details 7	406	0x0196	R/W		

14 Calibration

WARNING:

CALIBRATION IS ONLY REQUIRED FOR INSTRUMENTS IN WHICH CALIBRATION ERRORS HAVE BEEN ENCOUNTERED. REFER TO CALIBRATION CHECK BELOW.

CAUTION:

Calibration must be performed by personnel who are technically competent and authorised to do so.

Calibration Reminder

Calibration of each input type is carried out during manufacture. This can be verified from Product Information Mode. Recorder versions can provide the user with a calibration reminder if the application requires regular checks – see Input Configuration for details. For most applications, re-calibration is not required during the lifetime of the instrument.

Equipment Required For Checking or Calibrating The Universal Input

A suitable calibration signal source is required for each input type. To verify the accuracy of the instrument or carry out recalibration, the listed input sources are required. These must have better than $\pm 0.05\%$ of the reading accuracy:

1. DC linear inputs: 0 to 50mV, 0 to 10VDC and 0 to 20mADC.
2. Thermocouple inputs - complete with 0°C reference facility, appropriate thermocouple functions and compensating leads (or equivalent).
3. RTD inputs: decade resistance box with connections for three-wire input (or equivalent).

Calibration Check

1. Set the instrument to the required input type.
2. Power up the instrument and connect the correct input leads.
Leave powered up for at least five minutes for RTD and DC linear inputs, and at least 30 minutes for thermocouple inputs.
3. After the appropriate delay for stabilisation, check the calibration by connecting the appropriate input source and checking a number of cardinal points.
The observed readings should be within the tolerances stated in the Specification (see Appendix 2)
4. Repeat the test for all required input types.

Recalibration Procedure









Recalibration is carried out in five phases as shown in the table below; each phase corresponds to a basic input type.

CAUTION:

The 50mV phase MUST be calibrated before the thermocouple range.

Table 27. Input Calibration phases

DC milli-volt Calibration	50 mV
DC voltage Calibration	10 V
DC milliamps Calibration	20 mA
RTD Calibration	200 ohm
Thermocouple Calibration	K type source at 0°C

1. For optimum accuracy, power-up the instrument for 30 minutes, then toggle the power off/on to restart the instrument.
2. During the power-up “splash screen”, press  and  together until the Calibration Status screen is displayed.
3. Press  to select the first calibration phase (50mV Calibration)
4. Ensure that an accurate 50mV signal has been applied to terminals 2 (+ve) and 3 (-ve), then press  +  to initiate the calibration.
5. During calibration the message “50mV DC Input Calibrating” will display for a few seconds. This should be followed by the “Calibration Successful” confirmation.
6. If the input is misconnected or an incorrect signal is applied, the calibration will be aborted and the display will show “Failed: Signal Too Small!” or “Failed: Signal Too Large!”. The previous calibration value will be retained.
7. Press  to select the next calibration phase.
8. Repeat this process for each input type until all the phases are calibrated. For each phase, ensure that the correct input is applied, using the correct connections.
9. Once all calibration phases are completed, recorder versions will display the Calibration Reminder Date. If required, this can be changed to the date of your next calibration check. Ensure that Calibration Reminders are enabled in Input Configuration to receive a reminder.
10. Press  +  to exit to the main menu.

Note:

Calibration Mode automatically exits if there is no button activity for two minutes.

15 Appendix 1 – Glossary of Terms Used

Active Setpoint

The term Active Setpoint is used to describe the currently selected setpoint when the instrument is in Controller Mode. Controllers can use Local Setpoint 1 and/or the Alternative Setpoint. Only one of the setpoints can be active at any time. During Profiler Control, the setpoint value is controlled by the profiler function.

Also refer to: Actual Setpoint, Alternative Setpoint, Controller Mode, Local Setpoints, Profiler Mode, Remote Setpoint, Setpoint, and Setpoint Selection.

Actual Setpoint

Actual Setpoint is the effective current value of the active setpoint. This will be different to the Active Setpoint's target value if the setpoint is ramping. The actual setpoint will rise or fall at the ramp-rate set, until it reaches its target setpoint value. During Profiler Control, the Actual Setpoint value is controlled by the profiler function.

Also refer to: Active Setpoint, Controller Mode, Profiler Mode, Setpoint, Setpoint Ramp Rate and Setpoint Selection.

Alarm Configuration

A sub-menu of Configuration Mode used to adjust the alarm parameters. (Alarm types, values, hysteresis and inhibiting).

Also refer to: Alarm Hysteresis, Alarm Inhibit, Alarm Operation, Alarm Types and Configuration Mode.

Alarm Hysteresis

An adjustable band through which the process variable must pass before the alarm will change state. This Hysteresis is only applicable to alarms based on the Process Value or Control Deviation, as illustrated below. The band is always on the "safe" side of an alarm point, e.g. a high alarm's hysteresis band is below the high alarm value, and a low alarm's hysteresis is above the low alarm value. Rate Of Change Alarms have a different type of hysteresis based on the length of time the rate is above the threshold.

Settings = 1 LSD to full span from the setpoint.

Default value = 1 LSD.

Refer to the *Alarm Hysteresis Operation* diagram on the next page.

Also refer to: Alarm Types, Loop Alarm, Alarm Operation, LSD, Minimum Duration Of Change, Process Variable, and Rate Of Change Alarm.

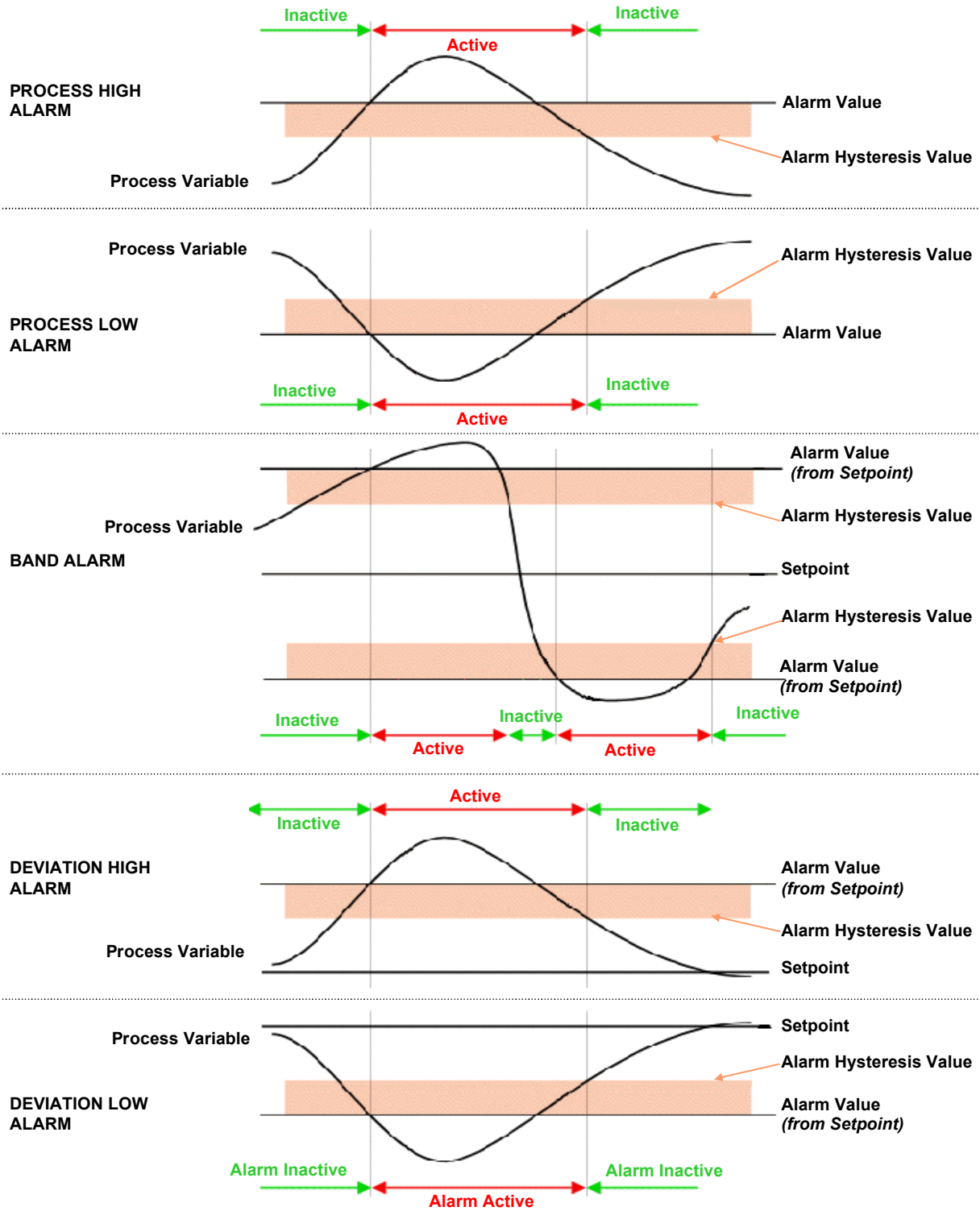

Alarm Operation

The Process and Deviation Alarm types are illustrated, together with the action of any associated outputs.

Also refer to: *Alarm Hysteresis, Alarm Inhibit, Alarm Types, Band Alarm Value, Deviation Alarm, Latching Relay, Logical Alarm Combinations, Loop Alarm, Process High Alarm and Process Low Alarm.*

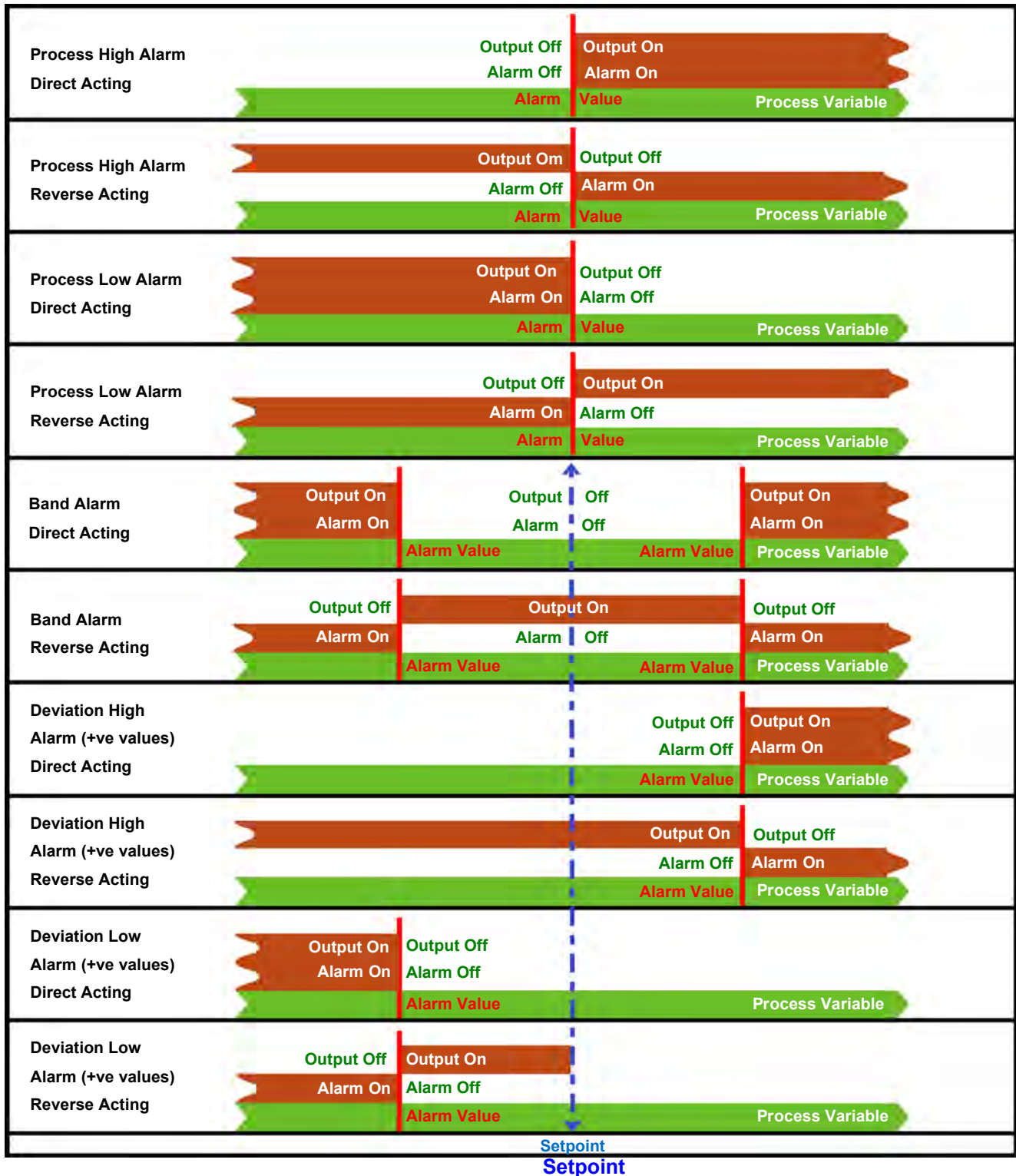

Figure 50. Alarm Operation

Alarm Inhibit

Alarm Inhibit prevents unwanted process or deviation alarm activation at power-up or when the controller setpoint is changed. The alarm activation is inhibited until a 'Safe' condition is present. The alarm operates normally from that point onwards. E.g. if inhibited, a low alarm will not activate at power-up, until the process has first risen above the alarm point and then falls back below.

Settings = Inhibit or not inhibited for each alarm.

Default value = None Inhibited.

Also refer to: Alarm Types and Alarm Operation.

Alarm Types

There are four basic alarm types, Process Alarms, Control Deviation Alarms, Rate of Signal Change Alarms and Event Based Alarms.

Process Alarms are based on the absolute value of the Process Variable. If the PV rises above a high alarm value, or falls below a low alarm value, the alarm will become active.

Deviation Alarms are based on the value of the Control Deviation error. If the PV is more than the high deviation alarm value above setpoint, or more than the low deviation alarm value below setpoint, the alarm will become active.

Rate Of Signal Change Alarms are based on the rate of change of the PV. If the rate of change is greater than the alarm value for longer than the Minimum Duration time, the alarm will activate.

Event based alarms activate when the condition for that alarm type is true. These can be Signal Break, Low Memory Or Loop Alarms.

Also refer to: Alarm Operation, Band Alarm Value, Control Deviation, Deviation Alarm, Loop Alarm, Process High Alarm, Process Low Alarm, Process Variable, Rate Of Change Alarm, and Setpoint.

Alternative Setpoint

The instrument can have up to two setpoints. Local Setpoint 1 and/or an Alternative Setpoint. The Alternative Setpoint can be chosen from Local Setpoint 2 or a remote setpoint input from Auxiliary Input A or B if either of these are fitted. One setpoint can be chosen as the active at using the Setpoint Selection.

Also refer to: Auxiliary Input, Local Setpoints, Remote Setpoints; Setpoint and Setpoint Select.

Auto Pre-Tune

When the Auto Pre-Tune is enabled, a Pre-Tune activation is attempted at every power-up (*standard Pre-Tune activation rules apply*). Auto Pre-Tune is useful when the process to be controlled may vary significantly each time it is run. Auto Pre-Tune ensures that the process is tuned correctly each time the process is started. Self-Tune may also be engaged to fine-tune the controller.

Settings = Enabled or Disabled.

Default value = Disabled.

Also refer to: Pre-Tune, Self-Tune, PID and Tuning.

Automatic Reset

- Refer to *Integral Action*

Bar Graphs

The instrument displays a bar-graph in the base operation mode screen. These can show PID Power Output (single control = uni-directional, dual control = bi-directional), Control Deviation (bi-directional) or for Data Recorder version %Memory Used (uni-directional). Bar-graphs are uni-directional or bi-directional depending on the information to be displayed.

Also refer to: Control Deviation, Data Recorder, Display Configuration, Operation Mode, Main Menu and PID

Bias (Manual Reset)

Used to manually bias proportional output(s) to compensate for control deviation errors due to process load variations. Bias is expressed as a percentage of output power. This parameter is not applicable if the Primary output is set to ON-OFF control. If the process variable settles below setpoint use a higher Bias value to remove the error, if the process variable settles above the setpoint use a lower Bias value. Integral action performs a similar function automatically when using PI or PID control.

Lower Bias values will also help to reduce overshoot at process start up.

Settings = 0 to 100% (-100% to +100% for dual control). Default value = 25%.

Also refer to: Control Deviation, Integral Action, ON/OFF Control, PI Control, PID, Proportional Control, Process Variable, and Setpoint.

Bumpless Transfer

A method used to prevent sudden changes to the correcting variable, when switching between automatic PI or PID and Manual control modes. During a transition from PI or PID to Manual control, the initial Manual Power value is set to the previous automatic mode value. The operator then adjusts the value as required. During a transition from Manual control to PI or PID, the initial automatic value is set to the previous Manual mode value. The correcting variable level will gradually adjusted by the control algorithm at a rate dependant on the integral action resulting from the Integral Time Constant value. Since integral action is essential to Bumpless Transfer, this feature is not available if Integral is turned off.

Also refer to: Correcting Variable, Integral Action, Manual Mode, PI and PID.

Cascade Control

Applications with two or more capacities (such as heated jackets) are inherently difficult for a single instrument to control, due to large overshoots and unacceptable lags. The solution is to cascade two or more controllers, each with its own input, in series to form a single regulating device. The product setpoint temperature is set on the master controller. This is compared to the product temperature, and the master's PID output (mA or VDC) is fed into the auxiliary input of the slave controller as a remote setpoint input. The RSP is scaled to suit any expected temperature. The slave loop's natural response time should ideally be at least 5 times faster than the master.

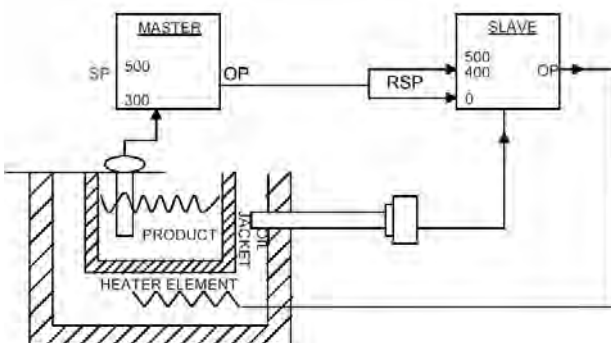

In the example, the maximum input represents 400°C, thus restricting the jacket temperature. At start-up the master compares the product temperature (ambient) to its setpoint (300°C) and gives maximum output. This sets the maximum (400°C) setpoint on the slave, which is compared to the jacket temperature (ambient) giving maximum heater output.

As the jacket temperature rises, the slave's heater output falls. The product temperature also rises at a rate dependant on the transfer lag between the jacket and product. This causes the master's PID output to decrease, reducing the 'jacket' setpoint on the slave, effectively reducing the output to the heater. This continues until the system becomes balanced.

When tuning a cascade system, first set the master to manual mode. Tune the slave controller using proportional control only (I & D are not normally required) then return the master to automatic PID mode before tuning the master. The result is quicker, smoother control with minimum overshoot and the ability to cope with load changes, whilst keeping the jacket temperature within acceptable tolerances.

Also refer to: Auxiliary Input, Auxiliary Input Lower Limit, Auxiliary Input Upper Limit, Derivative Action, Integral Action, mADC, Manual Mode, Master & Slave, Proportional Control, PID, Remote Setpoint, Remote Setpoint Lower Limit, Remote Setpoint Upper Limit, Setpoint, Setpoint Select, Tuning and VDC.

Clock Configuration

A sub-menu of Configuration Mode used to adjust the parameters that relate to the settings for the Real Time Clock fitted with the data recorder option (Date, time, day of week and date format).

Also refer to: Data Recorder and Configuration Mode

Communications Write Enable

Enables/disables the changing of parameter values via the Serial Communications link, if a communication option such as Modbus RTU (RS485) or Modbus TCP (Ethernet) is installed. When disabled, all communications are read-only.

Settings = Read Only or Read/Write.

Default setting = Enabled (read/write).

Also refer to: Ethernet, Modbus RTU, Modbus TCP, RS485 and Serial Communications

Configuration Menu

A selection of sub-menus from which the user can adjust the major instrument settings. There are sub-menus for the Inputs, Control, Outputs, Alarms, Communications, Recorder, Clock, Display and Lock Codes. Configuration Mode is entered from the Main Menu. An unlock code is required to access this mode.

Refer to the Configuration Menu information in the Configuration & Use section.

Also refer to: Alarm Configuration, Lock Codes, Clock Configuration, Control Configuration, Display Configuration, Input Configuration, Main Menu, Output Configuration, Recorder Configuration, Serial Communications Configuration

Contactors

- Refer to *Relay*

Control Configuration

A sub-menu of Configuration Mode used to adjust the parameters that relate to the control of the process. (Enabling control, auto/manual mode, control type and action, PID tuning terms, power limits, sensor break action, local setpoint values, setpoint ramp rates and setpoint selection).

Also refer to: Configuration Mode, Control Action, Control Enable, Local Setpoints, Manual Mode, PID, Power Limits, Sensor Break Pre-Set Power, Setpoint Ramping, Setpoint Selection and Tuning

Control Deviation

Control Deviation is the difference between the Process Variable value and the Actual Setpoint. The Control deviation error is equal to $PV - SP$. This value can be monitored using the bar-graph, and an excessive deviation warning can be given by using a deviation alarm.

Also refer to: Actual Setpoint, Alarm Types, Bar Graph, Deviation Alarm, Process Variable and Setpoint

Control Action

The primary power output direction. Reverse action is typically used with heating applications as it increases the correcting variable as the process variable falls. A secondary output's action is always the opposite of the primary output.

Settings = Reverse or Direct

Default value = Reverse.

Also refer to: Control Type, Correcting Variable, Direct Acting Control and Reverse Acting Control.

Control Enable/Disable

The PID controller outputs can be temporarily turned off by disabling the control. All other functions continue as normal. The control enable/disable function can be controlled from the Control Configuration sub-menu or optionally from Operation Mode or via a digital input if one is fitted.

Also refer to: Configuration Menu, Digital Input, Operation Mode and PID

Control Type

This defines if a controller has Single (unidirectional) or Dual (bidirectional) control outputs. Single outputs have a Primary output only. This can drive the PV in one direction (e.g. heat only, cool only, increase humidity etc). Dual outputs have both Primary and Secondary outputs which can force the PV to increase or decrease (e.g. heat & cool, humidify and dehumidify etc).

Settings = Single or Dual

Default value = Single.

Also refer to: Control Action, PID, Primary Proportional Band, Process Variable, and Secondary Proportional Band.

Controller

An instrument that controls a process variable to a target setpoint, by applying a correcting variable. The controller uses proportional (P, PI, PD or PID) or On-Off control methods.

Also refer to: Correcting Variable, Indicator, Limit Controller, On-Off Control, PD Control, PI Control, PID, Process Variable, Proportional Control, Profiler and Setpoint.

Controller Mode

The normal operating mode when profiling is not fitted or it is not being used.

Also refer to: Controller. Profiler and Profiler Mode

Correcting Variable

The amount of output from a controller used to adjust the process variable value up or down, to remove any control deviation. The correcting variable is commonly referred to as the controller output power.

Also refer to: Control Deviation, PID, Primary Power Output Limit and Process Variable

CPU

This stands for Central Processing Unit and refers to the onboard microprocessor that controls the measurement, control, alarm and display functions of the instrument.

Current Proportioning Control

Current proportioning control is used to produce the correcting variable on units with linear output(s). It provides 4 to 20mA, 0-20mA, 0 to 5V, 0 to 10V or 2 - 10V DC for proportional control, PI, PD or PID control modes. On-Off control cannot be used with linear outputs.

Also refer to: Correcting Variable, Linear Output, On-Off Control, PD, PI, PID, Proportional Control, and Time Proportional Control.

Custom Display Mode

The user can copy up to 50 Configuration Menu parameters into Operation Mode using the PC software. If the Custom Display is enabled in the Display Configuration sub-menu, these screens follow the normal Operation Mode screens. In this mode these screens are not pass-code protected.

Also refer to: Control Configuration, Display Configuration and Operation Mode

Cycle Time

For time proportioning outputs, the cycle time is used to define the time over which the controller averages the ON vs. OFF time, in order to provide the required correcting variable. Each Time-Proportioning output has its own adjustable cycle time. Shorter cycle times give better control, but at the expense of reduce life when used with electromechanical control devices (e.g. relays or solenoid valves). There are separate cycle times for the Primary and Secondary control outputs

Settings = 0.5 to 512 seconds

Default value = 32 secs.

Also refer to: Correcting Variable, PID, Primary Proportional Band, Proportional Control, Relay, Secondary Proportional Band, Solenoid Valve and Time Proportioning.

Data Recorder

The Data Recorder option can record the process value, setpoint, alarms and events over time. Recordings can be transferred to a USB memory stick or via the serial communications options. This option includes a USB Interface and a battery backed-up Real Time Clock.

Refer to the Data Recorder Option section of this manual for more details.

Also refer to: Recorder Configuration.

Deadband

- Refer to *Overlap/Deadband*.

Derivative Action

The Derivative Time Constant defines how the control action responds to the rate of change in the process variable. The power is decreased if the PV is rising, or increased if the PV is falling. This parameter is not available if primary control output is set to On-Off, and it is normally set to OFF in modulating value applications as it can cause premature wear due to constant small adjustments to the valve position.

Settings = OFF or 0 seconds to 99 minutes 59 seconds

Default value = 01.15.

Also refer to: Modulating Valve, On-Off Control, PD Control, PI Control, PID, Process Variable, Tuning and Valve Motor Drive Control.

Deviation Alarm Value

Defines the amount of control deviation considered acceptable before a deviation alarm is activated. A positive value (deviation high) sets the alarm point above the current actual setpoint, a negative value (deviation low) sets the alarm point below actual setpoint. If the process variable deviates from the actual setpoint by a margin greater than this value, the deviation alarm becomes active. If an alarm is required if the control deviation is either side of the setpoint, consider using a Band alarm or a logical combination of a deviation high and deviation low alarm.

Settings = 1 LSD to full span from the setpoint

Default value = 5 LSD's.

Also refer to: Actual Setpoint, Alarm Operation, Alarm Types, Band Alarm, Control Deviation, Logical Combination, Process Variable and Setpoint.

Digital Input

An input that can be driven to one of two states (active or inactive) by an external voltage or a contact opening/closing. Digital Inputs can be used to set the instrument in to different states. Possible uses are to select Auto/Manual Mode, Active Setpoint, Control Output Enable/disable, Profile Run/Hold/Abort, Hold Segment Release and Recording Start/Stop.

Also refer to: Active Setpoint, Control Enable, Data Recording, Manual Mode, Profiling and Segment Types.

Direct Acting Control

Direct action is required for applications where the primary control output will be used to force the process variable down towards the setpoint. A typical application is a Chiller. When the control action is selected as direct acting, primary proportional control outputs decrease the correcting variable as the process variable reduces within the proportional band, and primary On-Off outputs turn off when the process variable is less than the setpoint. The control action of a secondary output is always the opposite of the primary output.

Also refer to: Control Action, Control Type, Correcting Variable, On-Off Control, Process Variable, Proportional Control and Reverse Acting Control.

Display Configuration

A sub-menu of Configuration Mode used to adjust the display, and the parameters that relate to Operation Mode (Custom display enable, read-only operation mode, bar-graph formatting, trend setup, display colour & contrast and language selection).

Also refer to: Bar-Graphs, Configuration Mode, Custom Display Mode, Operation Mode, Main Menu and Trend Display.

Display Languages

The instrument supports two languages. The main language is English. The alternate language is chosen at time of order, but can also be changed by downloading a new file via the PC software. Current supported languages are English, French, German, Italian, Spanish, Russian and Czech.

Also refer to: Display Configuration, Operation Mode, and Main Menu.

Display Resolution

The maximum number of digits that can be displayed and/or the maximum number of decimal places. Numeric values (e.g. process variable, setpoints etc) are limited to no more than 5 digits.

The maximum number of decimal places is selectable from 0 to 3 places, but the overall 5-digit limit means that larger values may not display the full number of decimal places. For example, values >99.999 can have no more than 2 decimal places(e.g. 100.00).

Also refer to: LSD

Effective Setpoint

- Refer to *Actual Setpoint*.

Engineering Units

The Process Variable and Setpoint displays can assigned engineering units to describe the type of parameter connected to the process input. The engineering units for linear inputs can be: °C; °F; °K; bar; %; %RH; pH; psi or none. For temperature inputs (RTD or Thermocouples) they can be °C; °F or °K.

Also refer to: Linear Input, Process Input, Process Variable RTD and Thermocouple

Ethernet

A networking technology for local area networks (LANs). Used to link computers and other equipment in order to control or share data and control such devices. If fitted with an Ethernet serial communications module in Option Slot A, this instrument can connect to a Modbus TCP master device over a wired Ethernet LAN.

Also refer to: Modbus TCP and Serial Communications

Indicator

An instrument that displays process values, but lacks control features. Typically, alarm outputs are available that will activate at preset PV values.

Also refer to: Controller, Limit Controller and Process Variable.

Input Configuration

A sub-menu of Configuration Mode, used to adjust the parameters that relate to the process and auxiliary inputs (type, engineering units, decimal position, scaling, offset, filter auxiliary input settings etc.).

Also refer to: Auxiliary Input, Configuration Mode and Process Input.

Input Filter Time Constant

This parameter is used to filter out extraneous impulses affecting the process variable value. The filtered PV is used for all PV dependent functions (display, control, alarm etc). Use this parameter with care as it will also slow the response to genuine process changes.

Settings = OFF or 0.1 to 100.0 seconds.

Default value = 2.0 seconds.

Also refer to: Process Variable.

Input Range

This is the overall process variable input range and type as selected by the Process Input Type parameter. This range can be scaled by the Scale Range Upper & Lower Limits.

Also refer to: Input Span, Process Input, Scale Range Lower Limit and Scale Range Upper Limit.

Input Span

The measuring and display limits, as defined by the Scale Range Lower and Scale Range Upper Limits. The trimmed span value is also used as the basis for calculations that relate to the span of the instrument (e.g. proportional bands).

Settings = 100 LSD's to the full Input Range.

Default value = Input Range

Also refer to: Input Range, LSD, Primary Proportional Band, Scale Range Lower Limit, Scale Range Upper Limit and Secondary Proportional Band.

Integral Time Constant

Integral action biases proportional control output(s) to compensate for process load variations, until the control deviation value is zero. Integral Time Constant is also known as "Automatic Reset". Decreasing the time constant increases the Integral action. This parameter is not available if the primary output is set to On-Off.

Settings = 1 sec to 99 min 59 sec and OFF.

Default value = 05:00

Also refer to: Control Deviation, On-Off Control, PI Control, PID, Primary Proportional Band, Secondary Proportional Band, Derivative Action, and Tuning.

Latching Relay

A type of relay that, once it becomes active, requires a reset signal before it will deactivate. If latching relays are required, they can be fitted externally as slaves to the internal (non-latching) relays of this instrument.

Also refer to: Relay

LED

Light Emitting Diode. LED's are used as indicator lights (e.g. for the alarm indication, automatic tuning stats and manual mode).

Also refer to: Alarm Operation, Alarm Types, Automatic Tuning and Manual Mode.

Linear Input

A mVDC, mADC or voltage signal used to represent the value of the process variable. This can be any variable that can be converted into a suitable DC linear signal. Common examples are Humidity, pressure, pH or temperature.

Auxiliary linear inputs can also be installed, these can be used to provide a remote setpoint.

Also refer to: Auxiliary Input, Input Range, Linear Output, mVDC, mADC, Process Variable, Remote Setpoint and VDC.

Linear Output

A mVDC, mADC or voltage signal used to provide a proportional control or retransmit output.

Also refer to: Linear Input mVDC, mADC, Proportional Control, Retransmit Output and VDC

Limit Controller

A safety protection device that will shut down a process at a preset “exceed condition”. Limit controllers work independently of the normal process controller in order to prevent possible damage to equipment or products. A fail-safe latching relay is fitted, which cannot be reset by the operator until the process has returned to a safe condition. Limit controllers are highly recommended for any process that could potentially become hazardous under fault conditions.

Also refer to: Controller and Latching Relay.

Local Setpoints

Local setpoints are target values that are stored inside the controller. These are normally entered by from the front keypad, but can also be set via a serial communications link.

The instrument can have up to two setpoints. Local Setpoint 1 and/or an Alternative Setpoint. The Alternative Setpoint can be chosen from Local Setpoint 2 or a remote setpoint from an auxiliary input. One setpoint can be chosen as the active at using the Setpoint Selection. The value of the setpoints can be adjusted between the Setpoint Upper Limit and Setpoint Lower Limits.

Also refer to: Alternative Setpoint, Auxiliary Input, Remote Setpoint, Serial Communications, Setpoint, Setpoint Lower Limit, Setpoint Upper Limit, and Setpoint Select.

Lock Codes

The four-digit codes required when entering the Setup Wizard, Configuration Mode, Tuning Menu, Supervisor Mode, USB Menu, Recorder Menu and Profiler Setup Menu. These menus can be selected from the Main Menu. The correct code must be entered to gain access. If unlimited access is required for any of the menus, its lock can be turned off by setting the value to OFF. *Refer to the Lock Code View information in the Configuration & Use section.*

Settings = 1 to 9999 or OFF.

Default value = 10

Also refer to: Configuration Mode, Main Menu, Profiler Setup Menu, Recorder Menu, Setup Wizard, Supervisor Mode, Tuning Menu and USB Menu.

Logical Combination of Alarms

Outputs for alarms may be combined to create a Logical OR situation. Possible OR combinations are: Alarms 1 to 2; 1 to 3; 1 to 4 or 1 to 5.

Outputs for alarms & events may be combined to create a Logical AND situation. Possible AND combinations are: Alarm 1 & Event 1; Alarm 2 & Event 2; Alarm 3 & Event 3; Alarm 4 & Event 4; and Alarm 5 & Event 5.

Any suitable output may be assigned as a logical output and can be configured for reverse action or direct action. The following table explains the concept of logical OR & AND outputs.

Also refer to: Alarm Operation, Alarm Types, Output Configuration and Profile Events.

Table 28. Examples Of Logical Alarm Outputs

Logical OR: Alarm 1 OR Alarm 2											
Direct Acting						Reverse-Acting					
ALARM 1	OFF	ALARM 2	OFF	OUTPUT	OFF	ALARM 1	OFF	ALARM 2	OFF	OUTPUT	ON
	ON		OFF		ON		OFF		OFF		
	OFF		ON		ON		ON		ON		
	ON		ON		ON		ON		OFF		

Logical AND: Alarm 1 AND Alarm 2											
Direct Acting						Reverse-Acting					
ALARM 1	OFF	ALARM 2	OFF	OUTPUT	OFF	ALARM 1	OFF	ALARM 2	OFF	OUTPUT	ON
	ON		OFF		OFF		OFF		ON		
	OFF		ON		OFF		ON		ON		
	ON		ON		ON		ON		OFF		

Loop Alarm

A loop alarm detects faults in the control feedback loop, by continuously monitoring process variable response to the control output(s). If one of the 5 alarms is defined to be a loop alarm, it repeatedly checks if the PID control output is at saturation. If saturation is reached (0% or 100% power for single control type, -100% or +100% for dual control type), an internal timer is started. Thereafter, if the output has not caused the process variable to be corrected by a predetermined amount 'V' after time 'T' has elapsed, the alarm becomes active. Subsequently, the alarm repeatedly checks the process variable and the PID output. When the process variable starts to change value in the correct sense or when the PID output is no longer at the limit, the alarm is deactivated.

For PID control, the loop alarm time 'T' can be automatic (twice the Integral Time value) or set to a user defined value. Correct operation with the automatic loop alarm time depends upon reasonably accurate PID tuning. The user defined value is always used for On-Off control, and the timer starts as soon as an output turns on.

The value of 'V' is dependent upon the input type. For Temperature inputs, V = 2°C or 3°F. For Linear inputs, V = 10 x LSD

The loop alarm is automatically disabled during manual control mode and during execution of a Pre-Tune. Upon exit from manual mode or after completion of the Pre-Tune routine, the loop alarm is automatically re-enabled.

Also refer to: Alarm Types, Control Type, Manual Loop Alarm Time, Linear Input, LSD, Manual Mode, On-Off Control, PID, Pre-Tune, Process Variable and Tuning.

LSD

The Least Significant Digit (LSD) is the smallest incremental value that can be shown at the defined display resolution.

Also refer to: Display Resolution.

mADC

This stands for milliamp DC. It is used in reference to the linear DC milliamp input ranges and the linear DC milliamp outputs. Typically, these will be 0 to 20mA or 4 to 20mA.

Also refer to: Input Range, Linear Input, Linear Output,, mVDC, Process Variable and VDC

Main Menu

The top-level menu that allows access to operation mode as well as all other menus. These are: configuration mode, profiler setup and recorder menus, the setup wizard, supervisor mode and the tuning and USB menus. Most menus require an unlock code to gain access.

Refer to the Main Menu information in the Configuration & Use section.

Also refer to: Configuration Mode, Lock Codes, Operation Mode, Profiler Setup Menu, Recorder Menu, Setup Wizard, Supervisor Mode, Tuning Menu and USB Menu.

Manual Loop Alarm Time

The loop alarm time used when a loop alarm is defined to have a manually set time or whenever On-Off control is selected. This parameter determines the duration of the output saturation condition after which the loop alarm will be activated.

Settings = 1 sec to 99 mins 59 sec.



Default value = 99:59.

Also refer to: Loop Alarm, and On-Off Control.

Manual Mode

If Manual Mode is enabled/disabled (from the control configuration sub-menu, or the Auto/manual screen in operation mode if it is available) it allows the controller to switch between automatic and manual control modes. Auto/Manual Mode can also be switched using a digital input if one has been configured for this function. Switching between automatic and manual modes is achieved using “bumpless transfer”.

Manual Mode operates as follows:

The setpoint legend is replaced by the word **MAN** and setpoint value is replaced by a % output power value. This value may be adjusted using the  or  keys. The power value can be varied from 0% to 100% for controllers using single control type, and -100% to +100% for controllers using dual control type. It is possible to use a controller as a permanent “Manual Station” by selecting Manual Control in the control configuration sub-menu.

Caution: Manual Mode should be used with care because the power output level is set by the operator, therefore the PID algorithm is no longer in control of the process. The operator **MUST** maintain the process at the desired level manually. Manual power is not limited by the Power Output Limits.

Also refer to: Bumpless Transfer, Control Configuration, Control Type, Operation Mode, PID, and Power Output Limits.

Master & Slave Controllers

The terms master and slave are used to describe the controllers in multi-zone applications where one instrument controls the setpoint of another. These can be simple Setpoint Master/Slave applications where the master controller transmits its setpoint to the slaves via serial communications, or retransmits it as an analogue DC linear output signal. If serial comms are used, the master controller must be able to act as a communications master device and the slave must have a compatible communications option fitted. If DC linear retransmission is use, the slave controller must have a matching a remote setpoint input. It is possible to apply an offset to each zone if the slave has a Setpoint offset parameter or by offsetting it's remote setpoint input (or adjusting the scaling of this input).

Cascade Control is another type of Master & Slave application where the slaves setpoint is set using the master controllers PID power output. The terms Master and Slave are also used in a different context in relation to serial communications.

Also refer to: Cascade Control, Linear Output, Retransmit Output, Remote Setpoint, Auxiliary Input Offset, Serial Communications and Setpoint.

Minimum Duration Of Change

A form of alarm hysteresis unique to the Rate Of Change Alarm. It is the minimum time that the rate of change in the process variable must be above the alarm threshold, before the alarm will change state (from on to off, or off to on).

Settings = 1 to 9999 secs.

Default value = 1sec.

Caution: If the duration is less than this time, the alarm will not activate no matter how fast the rate of rise.

Also refer to: Alarm Hysteresis, Alarm Types and Rate Of Change Alarm.

Modbus RTU

Modbus RTU is the serial communications protocol used on instruments fitted with the RS485 Communications module into Option Slot A. Alternatively, the Modbus TCP protocol is available if the Ethernet Communications Module is fitted.

Modbus RTU is a Master/Slave protocol. Only the Master may initiate communications. Each slave is given a unique address, and the message contains the Modbus address of the intended slave. Only this slave will act on the command, even though other devices might receive it (an exception is specific broadcast commands sent to address 0 which are acted upon by all slaves but not acknowledged).

The commands can instruct the slave to change a value in one of its registers, or ask it to send back one or more values contained in its registers. The Modbus RTU format follows the messages with a cyclic redundancy check (CRC) checksum to ensure that the message arrives undamaged.

This instrument can act as a Slave or as a Setpoint Master over RS485. In this mode the unit continuously sends it's setpoint value using Modbus broadcast messages.

Refer to the Serial Communications and Modbus Parameter sections of this manual for more information.

Also refer to: Modbus TCP, RS485 and Serial Communications.

Modbus TCP

Modbus TCP is a version of the Modbus protocol for networks that support the Internet Protocol, such as Ethernet. It is available if the Ethernet Communications Module is fitted into Option Slot A.

This instrument can only act as a Slave when using Modbus TCP. A master device initiates the communications, and the instrument only acts on the command if it has been sent to its IP address. The data model and function calls used by Modbus TCP and RTU are identical; only the encapsulation is different. Modbus/TCP does not require a checksum to ensure that the message arrives intact.

Refer to the Serial Communications and Modbus Parameter sections of this manual for more information.

Also refer to: Ethernet, Modbus RTU and Serial Communications.

Modulating Valve

A valve that can be positioned anywhere between fully closed and fully open by means of an incorporated motor. A typical application would be controlling temperature in a furnace heated by gas burners. This instrument can control modulating valves that have a positioning circuit. These require proportional (mA or VDC) control signal from a linear output, relative to the desired valve position. PI control is used for valve control.

To directly control the valves 'open' and 'close' motor windings, a special Valve Motor Drive (VMD) controller algorithm is required. This instrument does not currently support this type of algorithm.

Also refer to: Linear Output, PI Control, Proportional Control and Valve Motor Drive Control.

Multi-Point Scaling

If the process input is connected to a linear input signal, multi-point scaling can be enabled in the Input Configuration sub-menu. This allows the linearization of a non-linear signal. The Scale Range Upper & Lower Limits define the values shown when the input is at minimum and maximum values, and up to 15 breakpoints can scale input vs. displayed value between these limits. It is advisable to concentrate these break points in the area of the range that has the greatest amount of non-linearity, or the area of particular interest in the application.

Also refer to: Input Configuration, Linear Input, Process Input, Scale Range Lower Limit and Scale Range Upper Limit.

mVDC

This stands for millivolt DC. It is used in reference to the linear DC millivolt input ranges. Typically, these will be 0 to 50mV or 10 to 50mV

Also refer to: Auxiliary Input, Input Range, Linear Input, mADC, Process Variable and VDC

On-Off Control

When operating in On-Off mode, the control output(s) will turn on or off as the process variable crosses the setpoint in a manner similar to a central heating thermostat. Some oscillation of the process variable is inevitable when using On-Off control.

On-Off control can be implemented only with Relay, Triac or SSR driver outputs. On-Off operation can be assigned to the Primary output alone (secondary output not present), Primary and Secondary outputs or Secondary output only (with the primary Output set for time proportional or current proportional control). On-Off Control is selected by setting the corresponding proportional band(s) to On-Off.

Also refer to: On-Off Differential, PID, Process Variable, Primary Proportional Band, Secondary Proportional Band, Relay, Setpoint, SSR Driver, Time Proportioning Control and Triac.

On-Off Differential (On-Off Hysteresis)

A switching differential, centred about the setpoint, when using On-Off control. Relay 'chatter' can be eliminated by proper adjustment of this parameter, but too large a value may increase process variable oscillation to unacceptable levels. On-Off differential is also known as hysteresis or deadband.

Settings = 0.1% to 10.0% of input span.

Default value = 0.5%.

Also refer to: Input Span, On-Off Control, Process Variable, Relay and Setpoint

Operation Mode

The mode used during normal operation of the instrument. It can be accessed from the Main Menu, and is the usual mode entered at power-up. The screens shown include a main screen with bar-graph, a trend view, information about the process, alarms plus optionally, selection of auto/manual control, control output disabling. Recorder and profiler information can be displayed if these features are fitted. Up to 50 configuration menu screens can be defined with the PC software, and will be shown if the Custom Display mode is enabled in the Display Configuration sub-menu.

Refer to the Operation Mode information in the Configuration & Use section.

Also refer to: Bar-Graphs, Configuration Mode, Custom Display Mode, Display Configuration, Main Menu, Profiler Setup Menu, Recorder Menu. and Trend Display.

Output Configuration

A sub-menu of Configuration Mode used to adjust the parameters that relate to the Outputs (Linear output type & scaling, output usage and scaling etc).

Also refer to: Configuration Mode and Linear Output.

Overlap/Deadband

The Overlap/Deadband parameter defines the portion of the primary and secondary proportional bands over which both outputs are active (called Overlap), or neither is active (called Deadband). This is adjustable in the range -20% to +20% of the sum of the two proportional bands. Positive values = Overlap, negative values = Deadband.

Overlap/deadband is applicable if the primary output is set for On-Off control or there is no Secondary Output. If the Secondary Output is set for On-Off, this parameter has the effect of moving the On-Off Differential band of the Secondary Output to create the overlap or deadband. When Overlap/Deadband = OFF, the edge of the Secondary Output Differential band coincides with the point at which the Primary Output = 0%.

The effect of the Overlap/Deadband parameter is shown in the following table

Settings = -20% to +20%.

Default value = 0.

Also refer to: On-Off Differential, On-Off Control, Primary Proportional Band and Secondary Proportional Band.

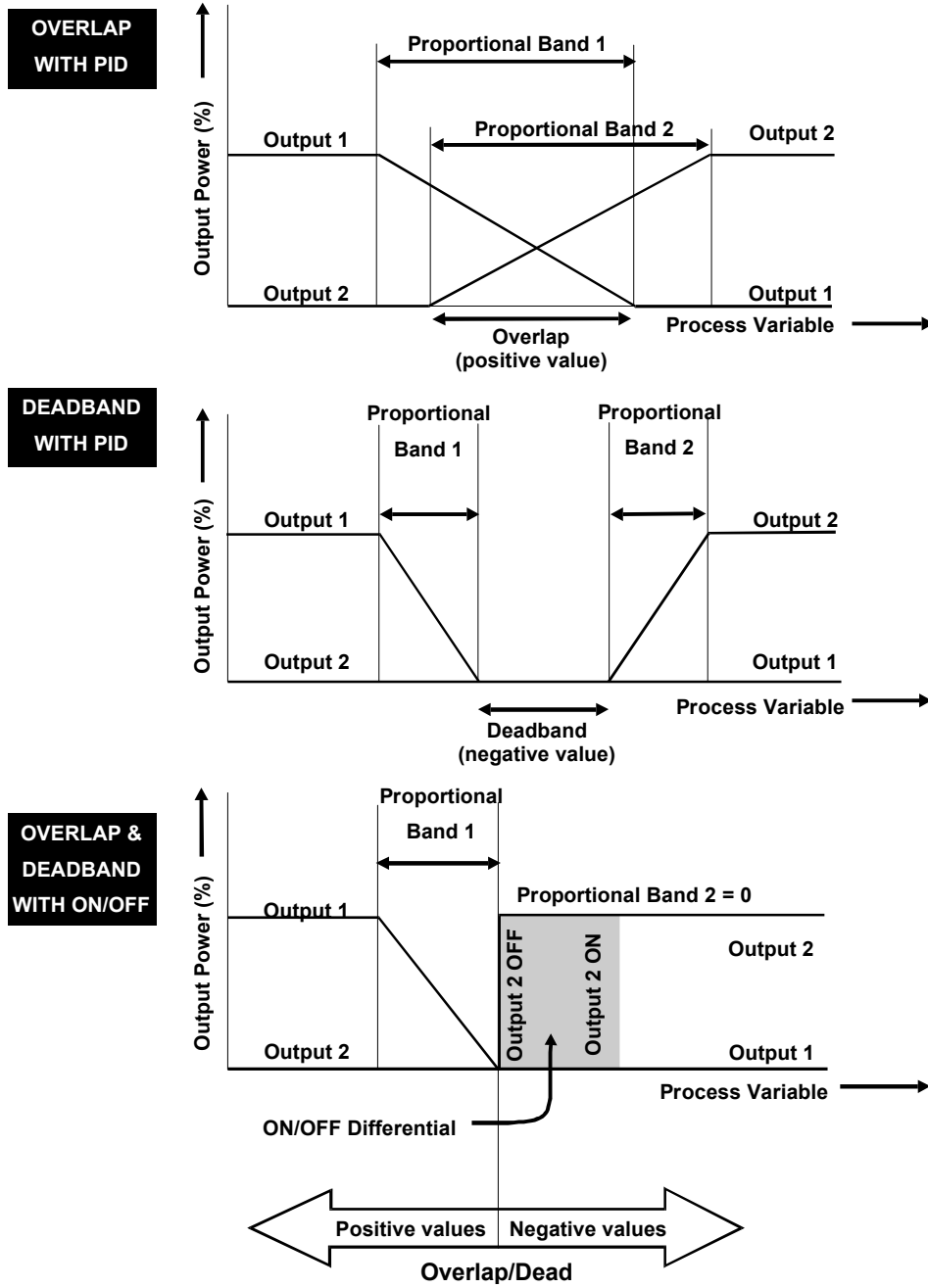

Figure 51. Overlap/Deadband

PD Control

Proportional and Derivative (PD) control combines proportional control with derivative action. It is similar to PID control, but without Integral action.

Also refer to: Derivative, Integral, PID Control, Proportional Control and Tuning.

PI Control

Proportional and Integral Control (PI) is most often used for modulating valve or motor control. It combines proportional control with integral action. It is similar to PID Control, but without derivative action that can cause excessive valve movement.

Also refer to: Derivative, Integral, Modulating Valve, PID Control, Proportional Control and Tuning.

PID Control

Proportional Integral and Derivative control maintains accurate and stable levels in a process (e.g. when controlling a temperature). Proportional Control avoids the oscillation characteristic of On-Off control by continuously adjusting the correcting variable output(s) to keep the process variable stable. Integral action eliminates control deviation errors, and Derivative action counters rapid process movements.

Also refer to: Control Action, Control Deviation, Control Enable, Control Type, Controller, Correcting Variable, Derivative Action, Integral Action, Manual Mode, On-Off Control, PD Control, PI Control, Primary Proportional Band, Process Variable, Secondary Proportional Band, Setpoint and Tuning.

PLC

This stands for Programmable Logic Controller. A microprocessor based device used in machine control. It is particularly suited to sequential control applications, and uses "Ladder Logic" programming techniques. Some PLC's are capable of basic PID control, but tend to be expensive and often give inferior levels of control.

Also refer to: PID.

Pre-Tune

The Pre-Tune facility artificially disturbs the start-up pattern so that a first approximation of the PID values can be made prior to the setpoint being reached. During Pre-Tune, the controller outputs full Primary Power until the process value has moved approximately halfway to the setpoint. At that point, power is removed (or full Secondary Power is applied for Dual Control), thereby introducing an oscillation. Once the oscillation peak has passed, the Pre-Tune algorithm calculates an approximation of the optimum PID tuning terms proportional band(s), integral and derivative. The Pre-Tune process is shown in the diagram on the next page.

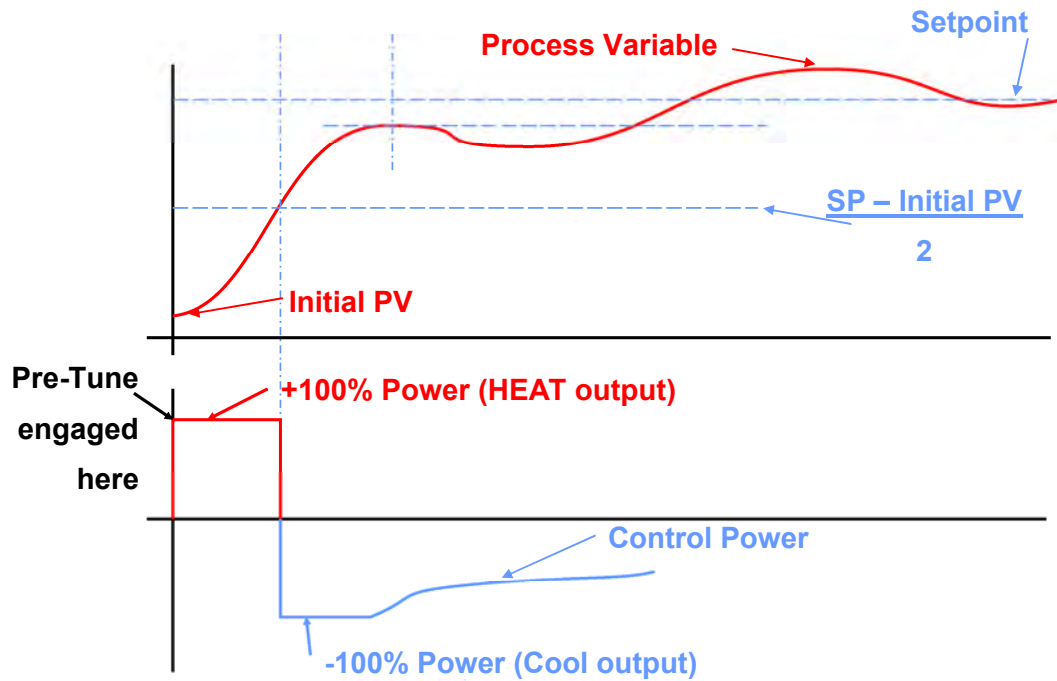

Figure 52. Pre-Tune Operation

When Pre-Tune is completed, the PID control output power is applied using the calculated values. Pre-Tune limits the possibility of setpoint overshoot when the controller is new or the application has been changed.

Pre-Tune can be selected from the Automatic Tuning Menu. It will not engage if either primary or secondary outputs on a controller are set for On-Off control, during setpoint/profile ramping or if the process variable is less than 5% of the input span from the setpoint. As a single-shot operation, Pre-Tune will automatically disengage once complete, but can be configured to run at every power up using the Auto Pre-Tune function.

Also refer to: Auto Pre-Tune, Control Type, Derivative Action, On-Off Control, Input Span, , Integral, PID, Primary Proportional Band, Process Variable, Secondary Proportional Band, Self-Tune, Setpoint, Setpoint Ramping, and Tuning.

Power Output Limits

Used to limit the power levels of the primary and secondary control outputs. Normally the instrument can set these outputs to any value between 0% and 100%. If this is undesirable in a particular application, individual settings can limit the primary power upper and lower levels and the secondary power upper and lower levels. The upper limit values must be higher than the lower limits. These parameters are not applicable if that output is set for On-Off control.

Use with caution: The instrument will not be able to control the process if the limits do not allow the outputs to be set to the correct values to maintain setpoint.

Lower Limit settings = 0% and 100%

Default Value = 0%.

Upper Limit settings = 0% and 100%

Default Value = 100%.

Also refer to: Control Type, On-Off Control and Setpoint.

Primary Proportional Band

The portion of the input span over which the Primary Output power level is proportional to the process variable value. Applicable if Control Type is single or dual. For dual control a Secondary Proportional band is used for the second output. The Control Action can be Direct or Reverse acting.

Settings = On-Off Control or 0.5% to 999.9% Default Value = 10%.

Also refer to: Control Action, Control Type, On-Off Control, Input Span, Overlap/Deadband, PID, Secondary Proportional Band, and Tuning.

Process High Alarm *n* Value

An independent high alarm value parameter is available for each alarm that is set as Process High type. It defines the process variable value above which Alarm *n* will be active.

Settings = Scale Range Upper to Lower Limit Default Value = Scale Range Upper Limit.

Also refer to: Alarm Operation, Alarm Types, Process Variable, Scale Range Lower Limit and Scale Range Upper Limit.

Process Input

The main input used to monitor the value process to be controlled. This is known as the Process Variable or PV. The input circuit is a "Universal" type, supporting all common thermocouples and PT100 RTDs as well as DC linear mV, voltage or mA signals suitable for almost any parameter that can be converted into a electronic signal. Linear signals can be scaled into engineering units using the Scale Range Lower Limit and Scale Range Upper Limit parameters.

Also refer to: Auxiliary Inputs, Engineering Units, Input Span, PV Offset, Process Variable , Scale Range Lower Limit and Scale Range Upper Limit.

Process Low Alarm *n* Value

An independent low alarm value parameter is available for each alarm that is set as Process Low type. It defines the process variable value below which Alarm *n* will be active.

Settings = Scale Range Upper to Lower Limit Default Value = Scale Range Lower Limit.

Also refer to: Alarm Operation, Alarm Types, Process Variable, Scale Range Lower Limit and Scale Range Upper Limit.

Process Variable (PV)

Process Variable is the parameter that is to be controlled. It is monitored by the main process input of the instrument, and can be any type that can be measured by that circuit. Common types are Thermocouple or RTD temperature probes, or pressure, level, flow etc from transducers that convert these parameters into DC linear input signals (e.g. 4 to 20mA). Linear signals can be scaled into engineering units using the Scale Range Lower Limit and Scale Range Upper Limit parameters.

Also refer to: Actual Setpoint, Engineering Units, Input Span, Linear Input, Process Input, RTD, Scale Range Lower Limit, Scale Range Upper Limit and Thermocouple.

Process Variable Offset

The Process variable offset is used to modify the measured process variable value. Use this parameter to compensate for errors in the displayed process variable. Positive values are added to the process variable reading, negative values are subtracted. **Caution:** This parameter is in effect, a calibration adjustment; it must be used with care. Injudicious use could lead to the displayed value bearing no meaningful relationship to the actual process variable. There is no front panel indication of when this parameter is in use.

Settings = \pm input span

Default Value = Off.

Also refer to: Input Span and Process Variable.

Profile Control Menu

If the Profiler option is fitted, a Profile Control menu is available from the Main Menu. It allows the user to select or run a profile, and then control that profile (run, hold, abort, skip to next segment etc.).

Refer to the Profiler Control Menu information in the Configuration & Use section.

Also refer to: Main Menu, Profile Setup Menu, Profiler and Profiler Mode.

Profile Events

Events are outputs that can be made active during profile segments. There are 5 possible events, each of which can be defined to be active or inactive for the duration of each segment, from the Profile Setup Menu. For end segments, events selected to be active stay on until the unit is powered down or a new profile runs. It is possible to link event outputs to certain alarm outputs in a logical AND situation.

Also refer to: Alarm Types, Logical Combinations, Profile Segments, Profile Setup Menu, Profiler and Profiler Mode

Profile Header

The profile header contains information about how the profile starts and stops, the power loss recovery action and if the profile should repeat multiple times when run.

Refer to the Profile Components information in the Profiler Option section of this manual.

Also refer to: Profile Segments, Profile Setup Menu, Profiler and Profiler Mode.

Profile Segments

Segments can be ramps, dwells, steps or special segments such as holds, ends or joins. A maximum of 255 segments are possible, shared amongst up to 64 profiles.

Refer to the Profile Components information in the Profiler Option section of this manual.

Also refer to: Profile Events, Profile Setup Menu, Profiler and Profiler Mode.

Profile Setup Menu

If the Profiler option is fitted, a Profile Setup menu is available from the Main Menu. It allows the user to set the General Profile Configuration parameters that apply to all profiles (e.g. Run/hold and abort methods etc), and to create or edit the Profile Header and Profile Segment Details. Profiles can also be deleted from this menu. This menu is protected by a lock code.

Refer to the Profiler Setup Menu information in the Configuration & Use section.

Also refer to: Lock Codes, Profile Control Menu, Profile Header, Profile Segments, Profiler and Profiler Mode.

Profiler

A profiler controls the value of the actual setpoint over time; increasing, decreasing or holding its value as required. This is used in applications where the rate of rise or fall of the process variable must be closely controlled, or where a value must be maintained for a period before moving to the next value.

If the Profiler option is fitted, up to 64 profiles can be created with a maximum of 255 profile segments shared amongst them. Each segment can activate/deactivate the five events according to the requirements of the process.

Refer to the Profiler Option section.

Also refer to: Actual Setpoint, Controller Mode, Profile Events, Profile Control Menu, Profile Header, Profile Segments, Profile Setup Menu and Profiler Mode.

Profiler Mode

This mode is entered when a profile is run. In profiler mode, additional screens are added to Operation Mode which show the status of the profile. These screens are not seen in Controller Mode. The instrument will remain in Profiler Mode when the profile finishes or is aborted unless the Segment End Type/Profile Abort Action is set to "Use Controller Setpoint".

Also refer to: Controller Mode, Profile Control Menu, Profile Segments, Profile Setup Menu, Profiler and Setpoint.

Proportional Control

Proportional control allows the correcting variable applied to the process to be set between 0 and 100% of the amount available. If the control type is dual, two outputs (primary & secondary) are available, each of which can give proportional control. When the Proportional Band(s) are correctly tuned, the process variable is maintained at a steady value, avoiding the oscillation characteristic of On-Off control. Proportional control is most commonly used in conjunction with Integral and Derivative action to give PI, PD or PID control.

Also refer to: Control Type, Correcting Variable, Derivative Action, Integral Action, On-Off Control, PD, PI, PID, Primary Proportional Band, Process Variable, Secondary Proportional Band, Setpoint and Tuning.

Rate

- Refer to *Derivative Action*.

Rate Of Change Alarm

An alarm based on the rate of change in the measured process variable. If the PV changes at a rate greater than the alarm level, the alarm will activate. The rate of change must be above the alarm threshold for longer than the Minimum Duration Of Change time, before the alarm will change state (from on to off, or off to on). **Caution:** If the duration is less than this time, the alarm will not activate no matter how fast the rate of rise.

Also refer to: Alarm Hysteresis, Alarm Operation, Alarm Types, Minimum Duration Of Change and Process Variable.

Recorder Configuration

If the Data Recorder is fitted, a Recorder Configuration sub-menu is added to Configuration Mode. This is used to adjust the recorder parameters (Recording mode, sample interval, trigger and values to record) and to show the recorder status.

Also refer to: Configuration Mode, and Data Recorder

Recorder Option

- Refer to *Data Recorder*.

Recorder Menu

If the Data Recorder is fitted, a Recorder Menu is added to the Main Menu. This is used to control the recording (start, stop, delete recordings etc) and to show the recorder status. This menu is protected by a lock code.

Refer to the Recorder Menu information in the Configuration & Use section.

Also refer to: Lock Codes, Main Menu and Data Recorder

Relay

An electromechanical switch operated by a solenoid coil. Relays are commonly fitted as internal, time proportioning controller outputs. The limited current capacity and switching cycles of internal relays means that they are usually connected to larger external slave relays/contactors which are capable of switching much larger currents and are easily replaced once worn out. A suitably rated RC snubber should be connected to relays to protect nearby equipment from the effects of noise generated as they switch (refer to the Noise Suppression details in the Electrical Installation section).

Also refer to: Current Proportioning Control, Latching Relay, SSR Driver, Time Proportioning Control and Triac

Remote Setpoint (RSP)

If the alternative setpoint type is selected to be a remote setpoint, and the selected setpoint is the alternative setpoint, an Auxiliary Input value is used to adjust the controller setpoint. The auxiliary linear input, is given a VDC or mADC signal, or in some cases potentiometer or mV inputs. The Remote Setpoint value is constrained by the Setpoint Upper Limit and Setpoint Lower Limit settings. Typical applications are Setpoint and Cascade Control Slaves.

Also refer to: Alternative Setpoint, Auxiliary Input, Auxiliary Input Lower Limit, Auxiliary Input Type, Auxiliary Input Upper Limit, Cascade Control, Linear Input, Local Setpoints, Master & Slave, mADC, mVDC, Setpoint and Setpoint Select, and VDC.

Retransmit Output

A linear VDC or mADC output signal, proportional to the Process Variable or Setpoint, for use by slave controllers or external devices, such as a Chart Recorder or PLC. The output can be scaled to transmit any portion of the input or setpoint span.

Also refer to: Input Span, Linear Output, mADC, Master & Slave, PLC, Process Variable, Retransmit Output Scale Maximum, Retransmit Scale Minimum, Setpoint and VDC.

Retransmit Output *n* Scale Maximum

Scales a linear output module in slot *n* if it has been selected to retransmit the PV or SP. Retransmit Scale Maximum defines the value of the process variable, or setpoint, at which the output will be at its maximum value. E.g. for a 0 to 5V output, it is the PV or SP value corresponding to 5V. If this parameter is set to a value less than that for Retransmit Output *n* Scale Minimum, the relationship between the process variable/setpoint value and the retransmission output is reversed so that higher PV/SP values give a lower output level.

Settings = -1999 to 9999

Default value = Scale Range Upper Limit.

*Also refer to: Process Variable, Retransmit Output, Retransmit Output *n* Scale Minimum, Scale Range Upper Limit and Setpoint.*

Retransmit Output *n* Scale Minimum

Scales a linear output module in slot *n* if it has been selected to retransmit the PV or SP. Retransmit Scale Minimum defines the value of the process variable, or setpoint, at which the output will be at its minimum value. E.g. for a 0 to 5V output, it is the PV or SP value corresponding to 0V. If this parameter is set to a value greater than that for Retransmit *n* Output Scale Maximum, the relationship between the process variable/setpoint value and the retransmission output is reversed so that higher PV/SP values give a lower output level. Settings = -1999 to 9999 Default value = Scale Range Lower Limit.

*Also refer to: Process Variable, Retransmit Output, Retransmit Output *n* Scale Maximum, Scale Range Lower Limit and Setpoint.*

Reset To Defaults

This Configuration sub-menu selection returns all of the instruments settings back to their factory defaults. It should be used with great care, as the action cannot be undone. A reset is followed automatically by the Setup Wizard. Users must use this wizard and/or configuration menus to set all of the parameters to the correct values for the intended application.

Also refer to: Configuration Menu, and Setup Wizard

Reverse Acting Control

Reverse control action is required for applications where the primary control output will be used to force the process variable up towards the setpoint. A typical application is a furnace. When the control action is selected as reverse acting, primary proportional control outputs decrease the correcting variable as the process variable increases within the proportional band, and primary On-Off outputs turn off when the process variable exceeds the setpoint. The control action of a secondary output is always the opposite of the primary output.

Also refer to: Control Action, Control Type, Correcting Variable, Direct Acting Control, On-Off Control and Proportional Control.

RS485

RS485 (also known as EIA-485) is two-wire, half-duplex, multi-drop serial communications connection. RS485 only defines the physical layer electrical specification, not the protocol that is transmitted across it. It uses differential signals (the voltage difference between the wires) to convey data. One polarity indicates a logic 1, the reverse polarity indicates logic 0. The applied voltages can be between +12 V and -7 volts, but the difference of potential must be > 0.2 volts for valid operation. RS485 can span distances up to 1200 metres using inexpensive twisted pair wires. Data speeds can be as high as 35 Mbit/s over 10 m and 100 kbit/s at 1200 m.

It is recommended that the wires be connected as series of point-to-point (multi-dropped) nodes (not in a star or ring format), with 120ohm termination resistors connected across the wires at the two ends of the network. Without termination resistors, reflections of the signals can cause data corruption, and electrical noise sensitivity is increased. The master device should normally provide powered resistors, to bias the wires to known voltages when they are not being driven by any device. Without biasing resistors, the data lines float and noise can be interpreted as data when actually all devices are silent.

Converters between RS485 and other formats are available to allow computers to communicate with remote devices. Repeaters can also be used to extend the distance and/or number of nodes on a network.

Also refer to: Modbus RTU, and Serial Communications

RTD

Resistance Temperature Detector. A temperature sensor that changes resistance with a change in the measured temperature. This instruments process input supports PT100 (platinum, 100Ω at 0°C) and NI120 (nickel, 120Ω at 0°C) sensors. These have positive temperature coefficients (PTC) which means their resistance increases with higher temperatures. The temperature measured by the sensor can be displayed as °C; °F or °K.

Also refer to: Input Range, Process Input and Thermocouple.

Scale Range Upper Limit

For linear inputs, this parameter is used to scale the displayed process variable. It defines the displayed value when the process variable input is at its maximum value (e.g. if 4 to 20mA represents 0 to 14pH, this parameter should be set to 14). The value can be set anywhere from -1999 to 9999 and can be set to a value less than (but not within 100 LSDs of) the Scale Range Lower Limit, in which case the sense of the input is reversed.

Settings = -1999 to 9999 Default value = 1000.

For thermocouple and RTD inputs, this parameter is used to reduce the effective span of the input. All span related functions work from the trimmed input span. The parameter can be adjusted within the limits of the range, but not less than 100 LSD's above the Scale Range Lower Limit.

Settings = Range Max to Min. Default value = Max value of selected temperature range).

Also refer to: Engineering Units, Input Range, Input Span, LSD, Process Variable and Scale Range Lower Limit.

Scale Range Lower Limit

For linear inputs, this parameter is used to scale the displayed process variable. It defines the displayed value when the process variable input is at its minimum value (e.g. if 4 to 20mA represents 0 to 14pH, this parameter should be set to 0). The value can be set from -1999 to 9999 and can be set to a value higher than (but not within 100 LSDs of) the Scale Range Upper Limit, in which case the sense of the input is reversed.

Settings = -1999 to 9999 Default value = 0.

For thermocouple and RTD inputs, this parameter is used to reduce the effective range of the input. All span related functions work from the trimmed input span. The parameter can be adjusted within the limits of the range, but not less than 100 LSD's below the Scale Range Upper Limit.

Settings = Range Max to Min. Default value = Min value of selected temperature range).

Also refer to: Engineering Units, Input Range, Input Span, LSD, Process Variable and Scale Range Upper Limit.

Secondary Proportional Band

The portion of the input span over which the Secondary Output power level is proportional to the process variable value. The Control action for the Secondary Output is always the opposite of the Primary output. The Secondary Proportional Band is only applicable when Dual Control Type is used.

Settings = On-Off Control or 0.5% to 999.9% Default Value = 10%.

Also refer to: Control Action, Control Type, On-Off Control, Input Span, Overlap/Deadband, PID, Primary Proportional Band and Tuning.

Self-Tune

Self-Tune continuously optimises tuning while a controller is operating. It uses a pattern recognition algorithm, which monitors the control deviation. The diagram shows a typical application involving a process start up, setpoint change and load disturbance.

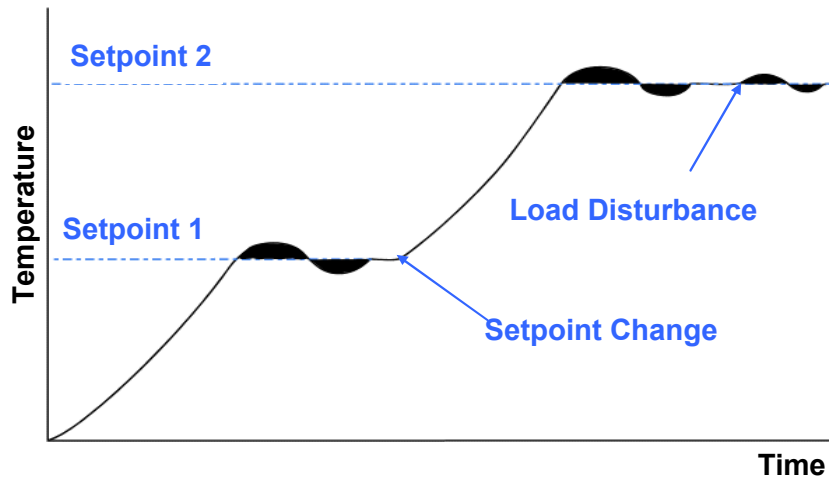

Figure 53. Self-Tune Operation

The deviation signal is shown shaded, and overshoots have been exaggerated for clarity. The Self-Tune algorithm observes one complete deviation oscillation before calculating a new set of PID values. Successive deviation oscillations cause the values to be recalculated so that the controller converges on optimal control. When the controller is switched off, these PID terms are stored, and are used as starting values at the next switch on. The stored values may not always be ideal, if for instance the controller is brand new or the application has changed. In these cases, the user can utilise Pre-Tune to establish new initial values. Self-Tune will then fine-tune these values as it monitors any control deviation.

Use of continuous self-tuning is not always appropriate. For example applications which are frequently subjected to artificial load disturbances, for example where an oven door is likely to be frequently left open for extended periods, can lead to errors in the calculations. In addition, because Self-Tune tunes for full PID control, it is not recommended for valve control applications, which normally require PI control.

Self-Tune cannot be engaged if the instrument is set for On-Off Control.

Also refer to: Control Deviation, Modulating Valves. On-Off Control, Pre-Tune, PI, PID, Setpoint and Tuning.

Sensor Break Pre-Set Power

If a thermocouple or RTD breaks, or it is disconnected, the instrument detects this condition within 2 seconds, and sets the control output(s) to the value defined by the Sensor Break Pre-Set Power Output parameter in the Control Configuration sub-menu. Process alarms behave as though the PV has gone high.

Non-zero based linear inputs (e.g. 2 to 10V or 4 to 20mA, but not 0 to 20mA) can also detect a sensor break condition, setting the power to the Pre-Set Power value. Process alarms behave as though the PV has gone low.

Also refer to: Input Range, Linear Input, RTD and Thermocouple.

Serial Communications Configuration

A sub-menu of Configuration Mode used to adjust the serial communications parameters. (Addressing, data rate, parity, master/slave settings and write enabling).

Also refer to: Configuration Mode, Serial Communications

Serial Communications Option

A feature that allows other devices such as PC's, PLC's or a master controller to read, or change the instruments parameters via an RS485 or Ethernet network.

Full details can be found in the Serial Communications sections of this manual.

Also refer to: Ethernet, Master & Slave, Modbus RTU, Modbus TCP, PLC, RS485 and Serial Communications Configuration.

Setpoint

The target value at which the instrument attempts to maintain the process variable, by adjusting its control output power (the correcting variable). There can be either one or two setpoints. Local Setpoint 1 and/or an Alternative Setpoint. The Alternative Setpoint can be chosen from Local Setpoint 2 or a remote setpoint input from Auxiliary Input A or B if either of these is fitted. One setpoint can be chosen as active using the defined Setpoint Selection method. Setpoint values are limited by the Setpoint Upper Limit and Setpoint Lower Limits.

Also refer to: Alternative Setpoint, Auxiliary Input, Correcting Variable, Local Setpoints, Process Variable, Remote Setpoint, Scale Range Lower Limit, Setpoint Lower Limit, Setpoint Upper Limit and Setpoint Select

Setpoint Upper Limit

The maximum value allowed for setpoints. It should be set to keep the setpoint below a value that might cause damage to the process. The adjustment range is between Scale Range Upper Limit and the Setpoint Lower Limit. If the value is moved below the current value of a setpoint, that setpoint will automatically adjust to keep within bounds.

Settings = Within Input Span

Default Value = Scale Range Upper Limit

Also refer to: Input Span, Scale Range Upper Limit, Setpoint and Setpoint Lower Limit.

Setpoint Lower Limit

The minimum value allowed for setpoints. It should be set to keep the setpoint above a value that might cause damage to the process. The adjustment range is between the Setpoint Upper Limit and the Scale Range Lower Limit. If the value is moved above the current value a setpoint, that setpoint will automatically adjust to keep within bounds.

Settings = Within Input Span

Default Value = Scale Range Lower Limit

Also refer to: Input Span, Scale Range Lower Limit, Setpoint and Setpoint Upper Limit.

Setpoint Ramp Editing

Enables or disables the viewing and adjustment of the setpoint ramp rate in Operation Mode. This parameter does not disable the ramping SP feature; it merely removes it from Operation Mode. It can still be viewed and adjusted in the Control Configuration sub-menu. To turn off ramping, the ramp rate must be set to OFF.

Settings = Enabled or Disabled

Default Value = Disabled

Also refer to: Control Configuration, Operation Mode, Process Variable, Setpoint and Setpoint Ramp Rate.

Setpoint Ramp Rate

The rate at which the actual setpoint value will move towards its target value, when the setpoint value is adjusted or the active setpoint is changed. With ramping in use, the initial value of the actual setpoint at power up, or when switching back to automatic mode from manual control, will be equal to the current process variable value. The actual setpoint will rise/fall at the ramp rate set, until it reaches the target setpoint value. Setpoint ramping is used to protect the process from sudden changes in the setpoint, which would result in a rapid rise in the process variable.

Settings = 1 to 9999 LSDs per hour.

Default Value = OFF

Also refer to: Active Setpoint, Actual Setpoint, LSD, Manual Mode, Process Variable, Setpoint, Setpoint Ramp Editing and Setpoint Selection.

Setpoint Selection

There can be either one or two setpoints. These can be Local Setpoint 1 or an Alternative Setpoint chosen from either Local Setpoint 2 or a remote setpoint input from Auxiliary Input A or B if these are fitted. The Setpoint Select parameter in the control sub-menu defines whether the Active Setpoint will be the Local Setpoint 1 only, the Alternative Setpoint only or if the choice of active setpoint will be made from a digital input or an Operation Mode selection screen.

Also refer to: Active Setpoint, Alternative Setpoint, Auxiliary Input, Digital Input, Local Setpoints, Remote Setpoint, Setpoint.

Setup Wizard

A sub-set of the Configuration Menu parameters chosen to allow inexperienced users to easily set the instrument up for most simple applications. The parameters shown depend on the options installed.

The Setup Wizard runs automatically at first ever power-up or whenever a Reset To Defaults is carried out. A partial Wizard also runs whenever option modules have been changed. The partial wizard only shows parameters affected by the changes made. The full Setup Wizard can also be run manually from the Main Menu (this requires entry of an un-lock code). Once completed, the Setup Wizard exits to Operation Mode.

Experts or users with more complex applications should select the parameters they wish to set-up from the Configuration Menus instead of using the Wizard.

Refer to the Setup Wizard information in the Configuration & Use section.

Also refer to: Lock Codes, Configuration Menu, Main Menu, Operation Mode and Reset To Defaults.

Solid State Relay (SSR)

An external device manufactured using two Silicone Controlled Rectifiers in reverse parallel. They can be used to replace mechanical relays in most AC power applications. Some special SSRs can switch DC, but most cannot. As a solid-state device, an SSR does not suffer from contact degradation when switching electrical current. Much faster switching cycle times are also possible, leading to superior control. The instrument's SSR Driver output provides a time-proportioned 10VDC pulse for to the SSRs signal input terminals. This causes conduction of current from the line supply through the SSR to the load, when the pulse is on.

Also refer to: Cycle Time, Time Proportioning Control, Relay, and Triac.

Solenoid Valve

An electromechanical device, use to control the flow of gases or liquids. It has just two states, open or closed. Usually, a spring holds the valve closed until a current is passed through the solenoid coil forces it open. Standard process controllers with time-proportioned or On-Off outputs can be used to control these types of valves.

Solenoid valves are often used with high/low flame gas burners. A bypass supplies some gas at all times, but not enough to heat the process more than a nominal amount (low flame). A controller output opens the solenoid valve when the process requires additional heat (high flame).

Also refer to: Modulating Valves, On-Off Control and Time Proportioning Control.

Supervisor Mode

Supervisor Mode allows access to a lock code protected sub-set of the main configuration parameters. The unlock code is different from the higher level Configuration Menu unlock code. Up to 50 Configuration Menu parameters can be chosen for inclusion in Supervisor Mode using the PC configuration software. If none have been chosen, this mode is disabled.

Refer to the Supervisor Mode information in the Configuration & Use section.

Also refer to: Configuration Menu and Lock Codes

Thermocouple

A temperature sensor made from two different metals. They convert temperature difference between their cold junction (the measuring instrument) and the hot junction, into a small signal or a few microvolts per °C. Thermocouples are cheap and interchangeable, but the wires and connectors used must match the metals used in their construction. They can measure a wide range of temperatures; some thermocouples can withstand very high temperatures such as furnaces. The main limitation of thermocouples is accuracy. The temperature measured by the thermocouple can be displayed as °C; °F or °K.

The colour codes for the common types are shown in the Thermocouple Wire Identification Chart in the Electrical Installation Section of this manual.

Also refer to: Engineering Units, Input Range, Process Input and RTD.

Three Point Stepping Control

Modulating valves normally require a special “Three Point Stepping” control algorithm. This which provides an output to move the valve further open, or further closed whenever there is a control deviation error. When this error is zero, no further output is required to maintain control unless load conditions change. This type of controller is often called a Valve Motor Drive controller. This instrument does not currently have a three point stepping algorithm.

However, modulating valves that have a valve positioning circuitry to adjust the valve position from a DC linear mA or voltage output signal can be controlled.

Also refer to: Control Deviation, Linear Output, Modulating Valve, and Valve Motor Control

Time Proportioning Control

Time proportioning control is accomplished by cycling the output on and off during the prescribed cycle time, whenever the process variable is within the proportional band(s). The PID control algorithm determines the ratio of time (on vs. off) to achieve the level of the correcting variable required to remove the control deviation error. E.g. for a 32 second cycle time, 25% power would result in the output turning on for 8 seconds, then off to 24 seconds. This type of output might be used with electrical contactors, solid state relays or solenoid valves. Time proportioning control can be implemented with Relay, Triac or SSR Driver outputs for either primary or secondary outputs.

Also refer to: Control Deviation, Correcting Variable, Current Proportioning Control, Cycle Time, PID, Primary Proportional Band, Relay, Secondary Proportional Band, Solenoid Valve, SSR and Triac.

Trend Display

Trend View is a graphical representation of recent process conditions. This feature is available on all variants. It does not rely on the Data Recorder option, and does not retain the stored data if the power is turned off. The trend shows the most recent 120 out of 240 stored data points. Its scale adjusts automatically for the best resolution for the visible data. This data can be the process variable; process variable & setpoint (shown as a dotted line), or the minimum and maximum value of the process variable measured since the last sample. Any active alarm(s) are indicated above the graph. The user can scroll the right hand cursor line back to examine all 240 data points. The sample interval and data to display is set in Display Configuration.

Also refer to: Alarm Types, Display Configuration, Operation Mode, and Process Variable, Setpoint.

Tuning

PID Controllers must be tuned to the process in order for them to attain the optimum level of control. Adjustment is made to the tuning terms either manually, or by utilising the controller's automatic tuning facilities. Tuning is not required if the controller is configured for On-Off Control.

Also refer to: Auto Pre-Tune, Controller, Derivative Action, Integral Action, On-Off control, PID, Pre-Tune, Primary Proportional Band, Self-Tune, Secondary Proportional Band and Tuning Menu.

Tuning Menu

The Tuning Menu can be accessed from the Main Menu. This menu is lock code protected. It gives access to the Pre-tune, Auto Pre-Tune and Self-tune facilities. These assist with PID tuning, by setting up Proportional band(s), Integral and Derivative parameter values. Tuning is not required for On-Off control.

Pre-tune can be used to set PID parameters approximately. Self-tune may then be used to optimise the tuning if required. Pre-tune can be set to run automatically after every power-up by enabling Auto Pre-Tune.

Refer to the Automatic Tuning information in the Configuration & Use section.

Also refer to: Auto Pre-Tune, Derivative Action, Integral Action, Lock Codes, Main Menu, On-Off control, PID, Pre-Tune, Primary Proportional Band, Self-Tune, Secondary Proportional Band and Tuning Menu.

Triac

A small internal solid state relay, which can be used in place of a mechanical relay in applications switching low power AC, up to 1 amp. Like a relay, the output is time proportioned, but much faster switching cycle times are also possible, leading to superior control. As a solid-state device, a Triac does not suffer from contact degradation when switching electrical currents. A snubber should be fitted across inductive loads to ensure reliable switch off the Triac. A triac cannot be used to switch DC power.

Also refer to: Cycle Time, Relay, SSR and Time Proportioning Control.

USB Menu

If the USB option is fitted, the USB Menu can be accessed from the Main Menu. This menu is lock code protected.

The USB Menu allows the user to read or write files to a USB memory stick. The current configuration of the instrument can be downloaded to the stick or the instrument can be completely reconfigured using a pre-stored file that has been downloaded earlier, created using the PC software, or even taken from another instrument.

If the Data Recorder option is present, the recordings can be downloaded to the stick for transport to the users PC for analysis. If the Profiler option is present, profiles can be downloaded to the stick or upload to the instrument using a pre-stored file that was downloaded earlier, created using the PC software, or even taken from another instrument.

Refer to the USB Menu information in the Configuration & Use section.

Also refer to: Data Recorder, Lock Codes, Main Menu and Profiler

Valve Motor Drive Control (VMD)

This instrument can only control modulating valves that have a valve positioning circuitry that adjusts the valve position according to the level a DC linear mA or voltage output signal. Such valves normally require PI control instead of full PID.

Motorised modulating valves that do not have this type of circuit require special Valve Motor Drive controllers which have a "Three Point Stepping" control algorithm.

Solenoid valves can also be controlled using the standard PID algorithm as they behave in a similar way to relays, having just two states, open or closed.

Also refer to: Control Deviation, Linear Output, Modulating Valve, PI Control, PID, Relay, Solenoid Valve, and Three Point Stepping Control.

VDC

This stands for Volts DC. It is used in reference to the linear DC Voltage input ranges. Typically, these will be 0 to 5V, 1 to 5V, 0 to 10V or 2 to 10VDC. Linear outputs can also provide DC voltages.

Also refer to: Auxiliary Input, Input Range, Linear Input, Linear Output, mADC and mVDC..

VMD

- Refer to *Valve Motor Control*.

16 PC SOFTWARE

The primary function of the software is to create, download and store instrument configurations and profiles. Additionally, changes can be made to the operation of the instrument; adding extra screens into Operation Mode, enabling and configuring Supervisor Mode, changing the contact details or the function of the front LED's. The software can also be used to download a new language file or to change the start-up "splash screen". An on-screen simulation of the instrument can be setup and tested on a configurable load simulator.

A additional software tool is available to set the IP address required for the Modbus TCP communications option - *refer to the IP Address Configuration section.*

Using The Software

The menus and button bar are used to select the main parameter screen or one of the other modes or functions. Hover the mouse over the parameter description or value to view a fuller description. Consult the comprehensive help (available from the Help Menu) for information about the general software functions.

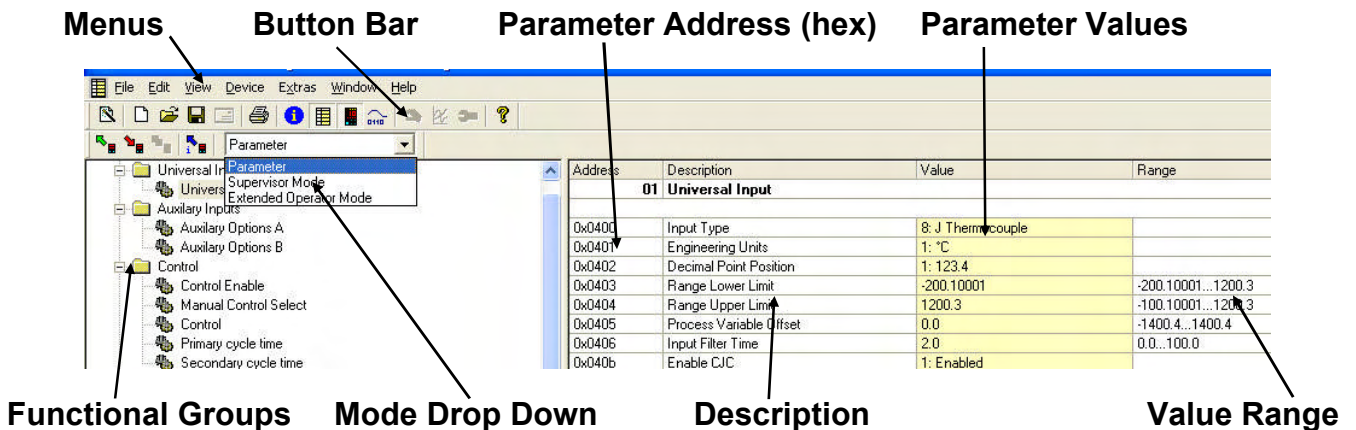

Figure 54. Main Parameter Screen

The main parameter screen is used to change all of the configuration and other settings. This screen also allows access to the Supervisor and Enhanced Operation Mode configuration screens from the Mode drop-down list. The Button bar or Device and View menus are used to access the other software functions.

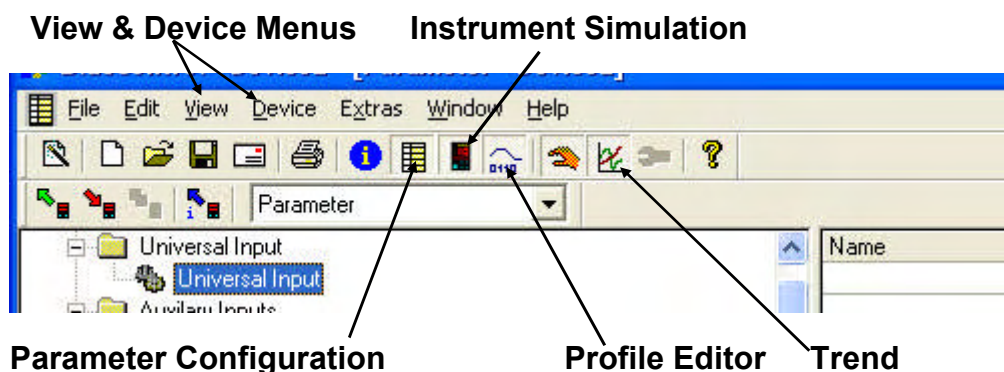
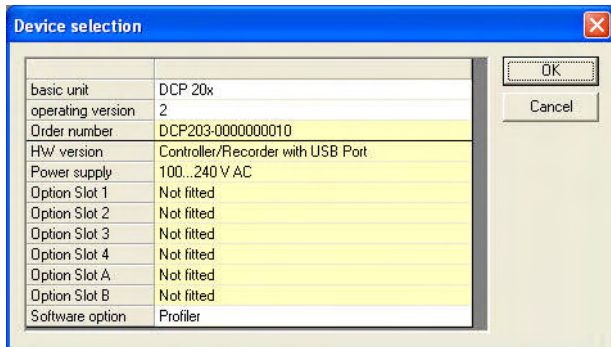

Figure 55. Button Bar & View Menu

Instrument Configuration



When creating a new configuration with the software, the basic instrument type and the options to be fitted to it must be defined in the Device Selection screen. You can select these from the drop down lists or by typing the full model number in the Order number field.

Note:

It is important that the options selected match those fitted to your unit.

Alternatively the complete instrument type and existing configuration can be uploaded to the PC from your instrument, via the configuration socket or serial communications module. A previously saved configuration file can also be opened from the file open menu or button. Once the required changes have been made, the configuration can then be download to the instrument or saved to disk with a .bct file extension. The configuration file contains the device information and configuration parameter settings, including any supervisor and enhanced operation mode screens and changes to the LED functions. Profiles, splash screens and language files are not saved in the .bct file. They are uploaded/saved separately.

A hard copy of the instrument configuration and terminal wiring can be printed from the File | Print menu.

Parameter configuration

The main parameter screen contains all of the instrument settings broken down into functional groups. The parameters can be changed in the yellow Value column. Type in a new value or select from the list offered, as appropriate. The possible value range is show to the left. If an invalid value is entered, it will be highlighted in red. Parameters are “greyed out” if the are currently inaccessible due the hardware not being fitted or if they are disabled by other settings.

Configuring Supervisor Mode

Users can access to a lock code protected sub-set of the configuration parameters that have been defined from the software. Up to 50 of the parameters can be copied into this mode. To define these screens, first select Supervisor Mode from the mode drop-down list.

Select the functional group containing the parameter to be added. Highlight the parameter Name and click the Add Entry button. The Move Entry Up and Down buttons are used to change the order which the parameters will appear in Supervisor Mode. Unwanted entries can be highlighted and deleted with the Remove Entry button.

Configuring Enhanced Operator Mode

Users can access sub-set of the configuration parameters at the end of the normal Operation Mode screen sequence, that have been defined from the software. Up to 50 parameters can be copied in a similar manner to the Supervisor Mode selection by selecting Enhanced Operation Mode from the mode drop-down list. Note: Any parameters copied into the Enhanced Operation mode are not password protected.

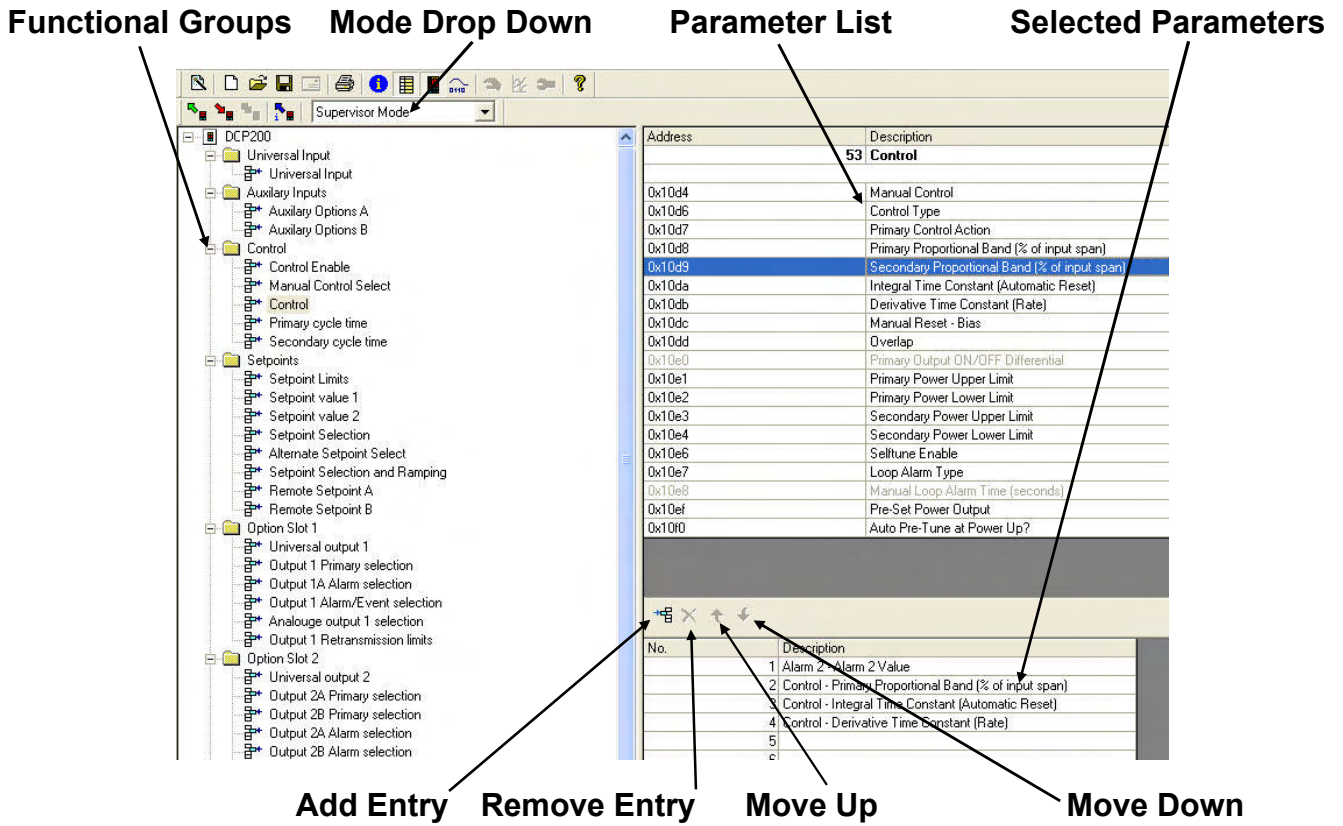

Figure 56. Supervisor/Enhanced Operation Mode Configuration

Profile Creation And Editing

Select the Profile Editor from the button bar or view menu. An existing profile file can be opened from the file open menu or button, or uploaded from an instrument connected to the PC via the configuration socket or serial communications module. The new profile can be download to the instrument or saved to disk with a .pfl file extension.

New / Open / Save / Print **Upload Profile** **Download Profile** **Mode Drop-Down**

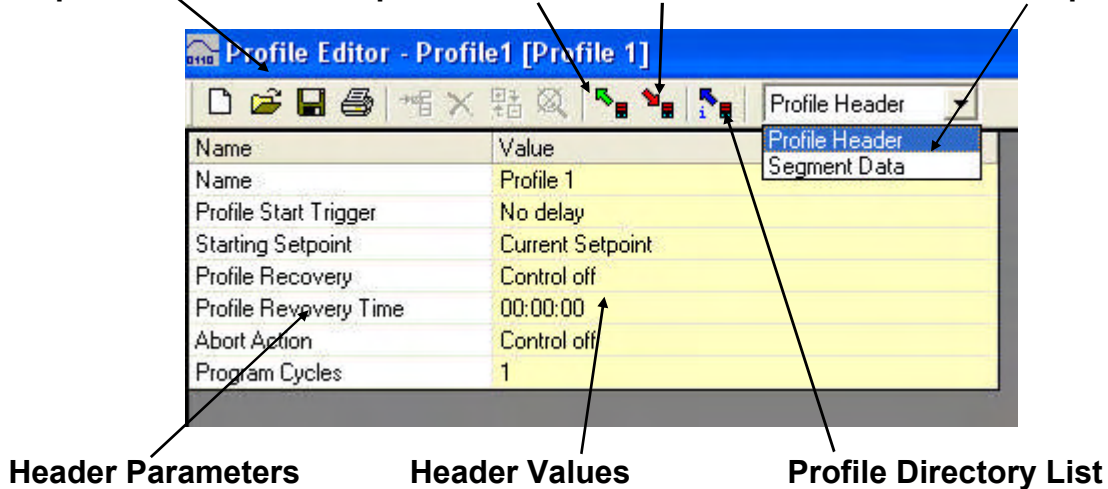

Figure 57. Profile Editor – Header



If the option to upload a profile is chosen, a list of profiles in the connected instrument is shown. The user can select the required profile from the list.

A directory of existing profiles in the instrument can also be requested. This allows one or all of the profiles to be deleted.

When downloading a profile to the instrument via the configuration socket or over serial communications, a list of existing profiles and empty profile slots is displayed. The user can select where to place the profile (a warning is shown if the profile will overwrite an existing profile).

The number of free segments still available is also shown.

A drop-down menu in the Profile Editor switches between the Profile Header and Segment Data. Refer to the *Profiler Setup Menu* and *Profiler Option* sections for full details of the header and segment data.

Header data includes a 16-character profile name, options for starting the profile after a delay or at a specific day and time, the starting setpoint, the action to take after a power failure or profile abort and the number of times the profile will run.

The segments are shown in Segment Data mode. The last segment is always an End, Join or Repeat Sequence type, and cannot be deleted. The user can select and change any segment's type and values, and they can insert additional segments before the selected one. A dynamically scaled graphic shows the segments of the profile, with the selected segment highlighted in red. The five profile events are shown below the graph.

A hard copy of the profile, including the graph and events can be printed from the File | Print menu.

Changing the Start-up Splash Screen

The graphic shown during the instrument start-up sequence can be changed from the main parameter screen. Select Download Splash Screen option from the Device menu. Choose your new graphic file (most common file types are supported). The chosen image will be converted to monochrome and be rescaled to 160 pixels wide by 80 pixels high. For best results, the image should be simple and have an aspect ratio of 2:1. Complex graphics with multiple colours or greyscales will not reproduce well. A preview of the results is shown. Click the Download button to store it to the instrument.

Changing the Alternate Display Language

The alternate language can be changed from the main parameter screen. Select the Download Language File option from the Device menu. Choose the correct file (language files have a .bin extension) and click the Open button to store it to the instrument.

Instrument Simulation

A fully functional and interactive instrument simulation is included with the software. This is linked to a simulated process, allowing changes to a configuration to be tested before use.

The simulated instrument can also be accessed and configured by pressing its “buttons” with your mouse, or by using the 4 arrow keys on your keyboard.

Active outputs are indicated in the panel to the right

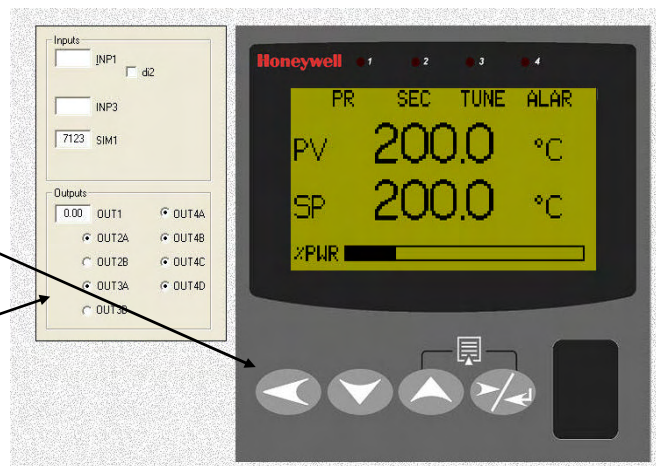

Figure 58. Honeywell DCP200 Simulation

Configuring The Connection

The software can communicate with the instrument via the RJ11 configuration socket located on the underside of the case, or via the Modbus TCP or RS485 communications options if either is fitted. *Refer to the wiring section for connection details.*

The configuration socket is intended for initial configuration of the instrument before installing in the application. An RS232 to TTL lead (*available from your supplier*) is required connect from the PC's RS232 serial port to this socket.

A front mounted USB port is available on some models; this can also be used to configure the instrument or transfer profile files, via a USB memory stick.

CAUTION:

The configuration lead/socket is not isolated from the process input or SSR Driver outputs. It is not intended for use in live applications.

A communications settings screen is shown whenever the user attempts to connect to the instrument from the software. The settings must be correct in order for communications to work successfully. First correctly select Configuration Socket or Bus as the Device connector, and select the PC Serial Com port that you have connected to. For Modbus TCP, select Ethernet (bus coupler).

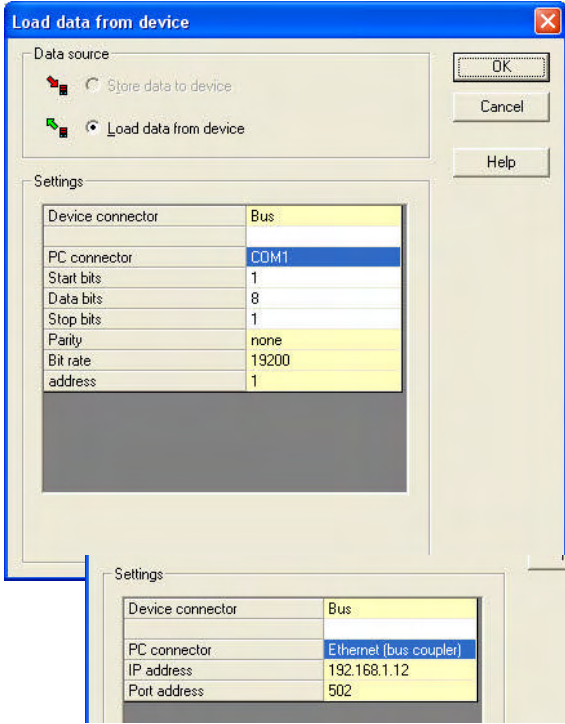

If connecting via the configuration port, the Start and Stop bits must be 1 and Data bits 8. Parity must be None and address 1. The data bit-rate should be 4800 if Slot A is fitted with an Auxiliary input, 9600 if the Ethernet option is installed or 19,200 for a Digital Input or if Slot A is empty.

If the instrument has an RS485 module fitted, the Address, Parity and Bit rate values must match those of the instrument (even if you are connecting via the configuration port). The Start and Stop bits must be 1 and Data bits 8.

If connecting via the Modbus TCP module, enter the instrument's IP address and set the Port address to 502

USB Memory Stick Folders & Files

If a USB memory stick is to be used to transfer files between the instruments and/or the software, the files must be stored in specific **DEVICE**, **CONFIG** and **PROFILE** folders on the USB stick. When saving files from the software to the memory stick, ensure that you save them to the correct folder. Local storage on you PC can be in any folder of your choosing. The USB option also limits the file name to 8 characters plus the 3 digit . bct or .pfl extension. Longer file names will be truncated.

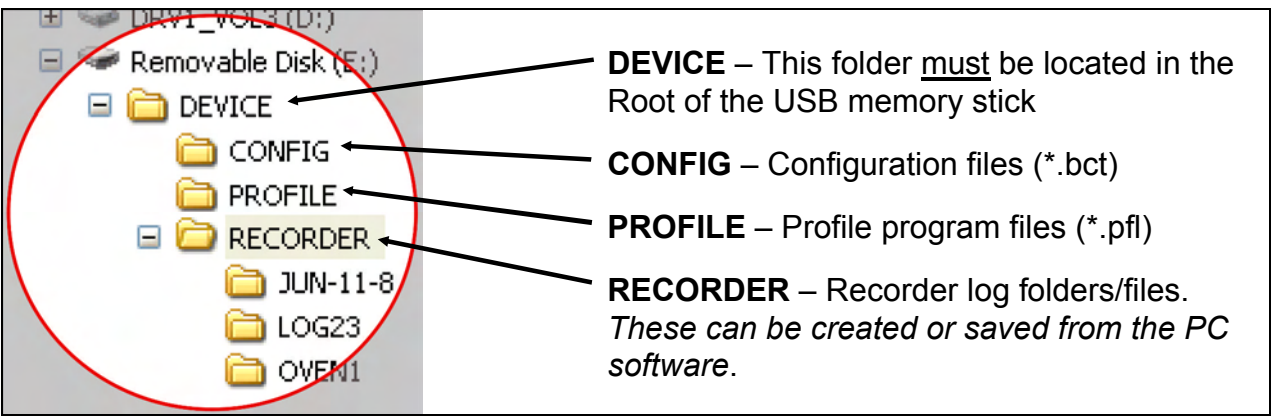

CAUTION:

When saving a file, the data will be overwritten if the file name already exists.

Network Configuration For Modbus TCP Options

If the instrument has the Modbus TCP communications option fitted, an IP address must be assigned to it in order for it to communicate with the Modbus TCP master device over your Ethernet network. The instrument can automatically receive an IP address if your network is set up to assign addresses to Ethernet devices connected to it. Alternatively, a fixed IP address can be assigned to it manually.

The Graphical Controller Ethernet Configuration tool is provided in order to discover or assign the IP Address of the instrument and configure the settings.

Setting the IP Address

Install and run the Graphical Controller Ethernet Configuration software on your PC. Connect the instrument to your network by plugging an Ethernet cable into the RJ45 socket on the top of the case. If your PC is not connected to a network, the instrument can be connected to its Ethernet port directly.

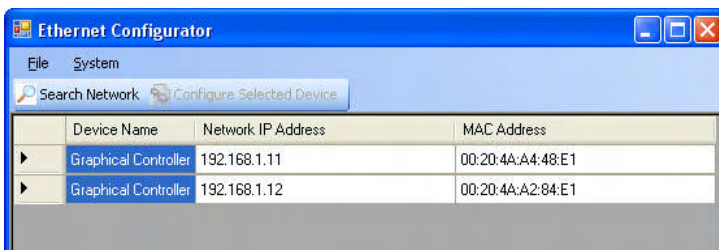

If your network assigns IP addresses automatically, pressing the “Search Network” button will list any of the Graphical Controllers connected to it. Their Network IP Address and MAC Addresses are also shown. For most fixed networks, only instruments that

have the same numbers in the first 3 Octets of their IP address can be seen by the PC. In this case, use the method detailed in the “Fixing An IP Address” section below.

Highlight the instrument that you wish to configure in the list and press the “Configure Selected Device Button”.

The Current IP address on the network is shown in the Edit IP Address tab, as is the current configured IP address. A configured address of 0.0.0.0 means the instrument does not have a fixed address, allowing it to receive one from the network (via a DHCP, BootP or AutoIP server).

Set the value to 0.0.0.0 for automatic addressing, or set a new fixed IP address and press Apply.

Note:

If this number does not match your PC’s network addresses, further communication with the instrument will cease.

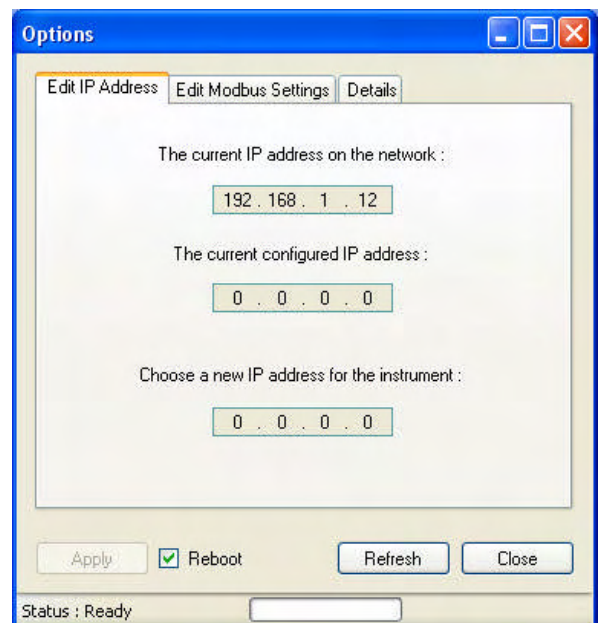

Instrument Details

The Details tab can be used to confirm communications with the instrument. When opened or refreshed, this tab collects the instruments Serial Number, Date of Manufacture and the Contact Details information, confirming that the Modbus TCP communications is functioning correctly.

Edit Modbus Settings

The Edit Modbus Settings tab configures the connection between the Ethernet module and the instrument's microprocessor. These settings **MUST** match with the settings in the instruments Communications Configuration menu. A faster baud rate can be used if large amounts of data are to be sent between the instrument and the master, but in most cases, it is recommended that the default settings are used.

Defaults:

Baud Rate	9600
Data Bits	Eight
Stop Bits	One
Parity	None

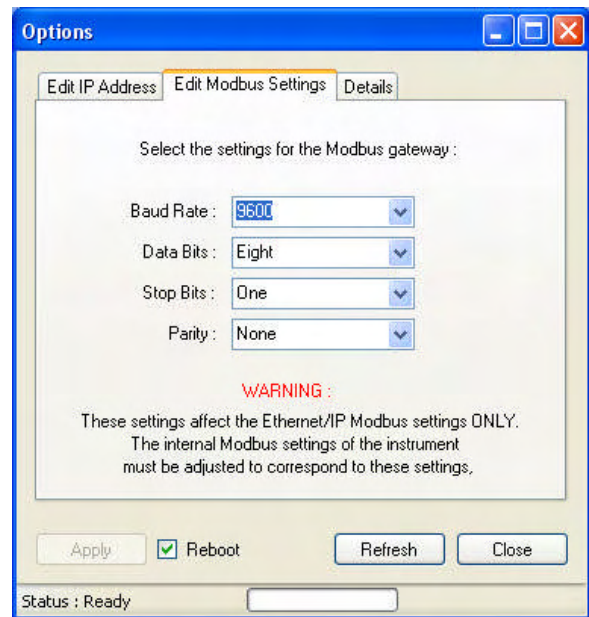

Fixing An IP Address

If your instrument cannot be found using the "Search Network" button, the IP address can be set from the Set IP Address option on the software's System menu.

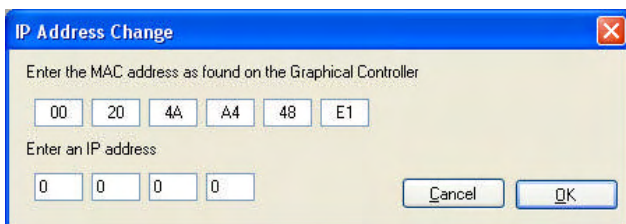

Enter it's MAC Address* and the new IP Address (use 0.0.0.0 for automatic addressing) then press okay.

*If your instruments 12 digit MAC Address isn't know, it can be found on a label attached to the RJ45 connector of it's Ethernet module.

17 Appendix 2 - Specifications

Universal Process Input

General Input Specifications

Input Sample Rate:	Ten samples per second.	
Digital Input Filter time constant	0.0 (OFF), 0.5 to 100.0 seconds in 0.5 second increments.	
Input Resolution:	Always four times better than display resolution. 16 bit ADC.	
Supply Voltage Influence:	Negligible effect on readings within the specified supply voltage tolerances.	
Relative Humidity Influence:	Negligible effect on readings within the specified humidity tolerance.	
Temperature Stability:	0.01% of span/°C change in ambient temperature.	
Input Impedance:	V DC:	47KΩ
	mA DC:	5Ω
	Other ranges:	Greater than 10MΩ resistive
Isolation:	Isolated from all outputs (except SSR Drivers) at 240V AC	
PV Offset:	Adjustable ±input span. +ve values are added to Process Variable, -ve values are subtracted from Process Variable	
PV Display:	Displays process variable up to 5% over and 5% under span.	

Thermocouple Input

Thermocouple Types & Ranges

Sensor Type	Range in °C	Range in °F
B	100 to 1824°C	211 to 3315°F
C	0 to 2315°C	32 to 4199°F
D	0 to 2320°C	32 to 4208°F
E	-240 to 1000°C	-400 to 1832°F
J (default)	-200 to 1200°C	-328 to 2192°F
K	-240 to 1373°C	-400 to 2503°F

Sensor Type	Range in °C	Range in °F
L	0 to 762°C	32 to °F
N	0 to 1399°C	32 to 2551°F
PtRh20%: PtRh40%	0 to 1850°C	32 to 3362°F
R	0 to 1759°C	32 to 3198°F
S	0 to 1762°C	32 to 3204°F
T	-240 to 400°C	-400 to 752°F

Note:

Defaults to °F for USA units. Defaults to °C for non-USA units.

The Scale Range Upper Limit and Scale Range Lower Limit parameters, can be used to restrict range. An optional decimal place can be displayed up to 999.9°C/F

Thermocouple Performance

Calibration:	Complies with BS4937, NBS125 and IEC584.
Measurement Accuracy:	±0.1% of full range span ±1LSD. NOTE: Reduced performance for B Thermocouple from 100 to 600°C. NOTE: PtRh 20% vs PtRh 40% Thermocouple accuracy is 0.25% and has reduced performance below 800°C.
Linearization Accuracy:	Linearization better than better ±0.2°C (±0.05 typical) for J, K, L, N and T thermocouples; than better than ±0.5°C for other types.
Cold Junction Compensation:	If enabled, CJC error is better than ±1°C under operating conditions.
Sensor Resistance Influence:	Thermocouple 100Ω: <0.1% of span error. Thermocouple 1000Ω: <0.5% of span error.
Sensor Break Protection:	Break detected within two seconds. Process Control outputs go to the pre-set power value. High and Sensor Break Alarms operate.

Resistance Temperature Detector (RTD) Input

RTD Types & Ranges

Sensor Type	Range in °C	Range in °F	Sensor Type	Range in °C	Range in °F
3-Wire PT100	-199 to 800°C	-328 to 1472°F	NI120	-80 to 240°C	-112 to 464°F

Note:

The Scale Range Upper Limit and Scale Range Lower Limit parameters, can be used to restrict range. An optional decimal place can be displayed up to 999.9°C/F

RTD Performance

Measurement Accuracy:	±0.1% of span ±1LSD.
Linearization Accuracy:	Better than ±0.2°C any point (±0.05°C typical). PT100 Input complies with BS1904 and DIN43760 (0.00385Ω/Ω°C).
Sensor Resistance Influence:	Pt100 50Ω/lead balanced. Automatic Lead Compensation: <0.5% of span error.
RTD Sensor Current:	150µA (approximately).
Sensor Break Protection:	Break detected within two seconds. Process Control outputs go to the pre-set power value. High and Sensor Break Alarms operate.

DC Linear Input

DC Linear Types & Ranges

Input Type	Ranges	
mA DC	0 to 20mA	4 to 20mA
mV DC	0 to 50mV	10 to 50mV

Input Type	Ranges	
V DC	0 to 5V	1 to 5V
	2 to 10V	0 to 10V

DC Linear Performance

Display Scaling:	Scalable up to -9999 to 10000 for any DC Linear input type.
Minimum Span:	100 display units.
Decimal Point Display:	Decimal point selectable from 0 to 3 places, but limits to 5 display digits (e.g. values > 99.9 have no more than 2 decimal places).
DC Input Multi-Point Linearization:	Up to 15 scaling values can be defined anywhere between 0.1 and 100% of input.
Measurement Accuracy:	$\pm 0.1\%$ of span ± 1 LSD.
Maximum Overload:	1A on mA input terminals, 30V on voltage input terminals.
Sensor Break Protection:	Applicable for 4 to 20mA, 1 to 5V and 2 to 10V ranges only. Break detected within two seconds. Process Control outputs go to the pre-set power value. Low and Sensor Break Alarms operate.

Auxiliary Inputs

Auxiliary Input Types & Ranges

Input Type	Ranges – Auxiliary Input A	
mA DC	0 to 20mA	4 to 20mA
V DC	0 to 5V	1 to 5V
	2 to 10V	0 to 10V

Input Type	Ranges – Auxiliary Input B	
mA DC	0 to 20mA	4 to 20mA
V DC	0 to 5V	1 to 5V
	2 to 10V	0 to 10V
mV DC	0 to 100mV	10 to 50mV
Pot	2K Ω or higher	

Auxiliary Input Performance

Input Sampling rate:	4 per second.
Input Resolution:	16 bit ADC.
Auxiliary Input Scaling:	Scalable as a Remote Setpoint (RSP) input between -9999 and 10000, constrained by the Setpoint Limits.
Measurement Accuracy:	$\pm 0.25\%$ of input span ± 1 LSD.

Input resistance:	mV ranges : >10MΩ. Voltage ranges: 47KΩ. Current ranges: 5Ω.
Input protection:	Voltage input: will withstand up to 5x input voltage overload without damage or degradation of performance in either polarity. Current input: will withstand 5x input current overload in reverse direction and up to 1A in the normal direction.
Isolation:	Reinforced safety isolation from outputs and inputs (except to Digital Input B).
Sensor Break Detection:	Applicable for 4 to 20mA, 1 to 5V and 2 to 10V ranges only. Control goes to the pre-set power value if Auxiliary Input is providing the active setpoint source.

Digital Inputs

Digital Input Functions

Function	Logic High	Logic Low
Profile Run/Hold	Hold Running Profile	Run or release selected profile
Hold Segment Release	No Action	Release from Hold Segment
Profile Abort	No Action	Abort Running Profile
Data Recorder	Stop Recording	Start Recording
Internal Setpoint Select	Select Local Setpoint 1	Select Alternate Setpoint
Auto/Manual Control	Automatic Control Mode	Manual Control Mode
Control Outputs	Enable PID Control Outputs	Disable PID Control Outputs

The above actions apply if a digital input has been defined to control the specified function(s)

Digital Input Performance

Type:	Voltage-free or TTL-compatible.
Voltage-Free Operation:	Connection to contacts of external switch or relay: Open = Logic High. <i>Minimum contact resistance = 5KΩ</i> , Closed = Logic Low. <i>Maximum contact resistance = 50Ω</i> .
TTL levels:	2.0 to 24VDC = Logic High. -0.6 to 0.8VDC = Logic Low.
Digital Input Sensitivity:	Edge Sensitive. Requires High-Low or Low-High transition to change function.
Response Time:	Response within <0.25 second of signal state change.
Isolation:	Reinforced safety isolation from inputs and other outputs.

Output Specifications

Output Module Types

Option Slot 1 Options:	Single Relay, Single SSR Driver, Triac or DC linear.
Option Slot 2 Options:	Single Relay, Dual Relay, Single SSR Driver, Dual SSR Driver, Triac, DC Linear or 24VDC Transmitter Power Supply.
Option Slot 3 Options:	Single Relay, Dual Relay, Single SSR Driver, Dual SSR Driver, Triac, DC Linear or 24VDC Transmitter Power Supply.
Option Slot 4 Options:	Quad Relay.

Single Relay Output Performance

Contact Type:	Single pole double throw (SPDT).
Contact Rating:	2A resistive at 240V AC
Lifetime:	>500,000 operations at rated voltage/current.
Isolation:	Reinforced safety isolation from inputs and other outputs.

Dual Relay Output Performance

Contact Type:	2 x Single pole single throw (SPST) with shared common.
Contact Rating:	2A resistive at 240V AC.
Lifetime:	>200,000 operations at rated voltage/current.
Isolation:	Reinforced safety isolation from inputs and other outputs.

Quad Relay Output Performance

Contact Type:	4 x Single pole single throw (SPST).
Contact Rating:	2A resistive at 240V AC.
Lifetime:	>500,000 operations at rated voltage/current.
Isolation:	Reinforced safety isolation from inputs and other outputs.

Single Dual SSR Driver Output Performance

Drive Capability:	10VDC minimum at up to 20mA load.
Isolation:	Not isolated from the universal input, Ethernet communications or other SSR driver outputs.

Dual SSR Driver Output Performance

Drive Capability:	10VDC minimum at up to 20mA load.
Isolation:	Not isolated from the universal input, Ethernet communications or other SSR driver outputs.

Triac Output Performance

Operating Voltage:	20 to 280Vrms @47 to 63Hz.
Current Rating:	0.01 to 1A (full cycle rms on-state @ 25°C); derates linearly above 40°C to 0.5A @ 80°C.
Non-repetitive Surge Current:	25A peak maximum, for <16.6ms.
OFF-State dv/dt:	500V/μs Minimum at Rated Voltage.
OFF-State leakage:	1mA rms Maximum at Rated Voltage.
ON-State Voltage Drop:	1.5V peak Maximum at Rated Current.
Repetitive Peak OFF-state Voltage, V_{drm}:	600V minimum.
Isolation:	Reinforced safety isolation from inputs and other outputs.

DC Linear Output Types & Ranges

Input Type	Ranges	
	mA DC	0 to 20mA

Input Type	Ranges	
	V DC	0 to 5V
	2 to 10V	

DC Linear Output Performance

Resolution:	Eight bits in 250mS (10 bits in 1 second typical, >10 bits in >1 second typical).
Update Rate:	Every control algorithm execution (10 times per second).
Load Impedance:	0 to 20mA & 4 to 20mA: 500Ω maximum. 0 to 5V, 0 to 10V & 2 to 10V: 500Ω minimum. Short circuit protected.
Accuracy:	±0.25% (mA @ 250Ω, V @ 2kΩ). Degrades linearly to ±0.5% for increasing burden (to specification limits).
Over/Under Drive:	For 4 to 20mA and 2 to 10V a 2% over/underdrive is applied (3.68 to 20.32mA and 1.84 to 10.16V). When used as control output
Isolation:	Reinforced safety isolation from inputs and other outputs.
0 to 10VDC Transmitter Power Supply*	Can be used to provide an adjustable 0.0 to 10.0V (regulated), up to 20mA output to excite external circuits & transmitters.

24V Transmitter Power Supply Performance

Power Rating	19 to 28VDC (24V nominal) up to 20mA output, to for external circuits & transmitters.
Isolation:	Reinforced safety isolation from inputs and other outputs.
<i>*see Linear output (above) for adjustable 0 to 10V Transmitter Power Supply</i>	

Communications

Supported Communication Methods

Type	Function
PC Configuration Socket	Direct configuration using the PC Configuration Software
RS485	Configuration and general communications using Modbus RTU.
Ethernet	Configuration and general serial communications using the Modbus TCP protocol.
USB	Upload/download of configuration/profile files from the PC Software or other instruments and download for Data Recordings.

PC Configuration Socket

Type:	RS232 Serial Communications
Connection	PC Configurator Cable to RJ11 socket under case.
Isolation:	Not isolated from input or SSR Driver outputs. For bench configuration only. CAUTION: Not for use in live applications.

RS485

Type:	RS485 Asynchronous Serial Communications Module.
Connection	Locates in Option Slot A. Connection via rear terminals (<i>refer to wiring diagram</i>).
Protocol:	Modbus RTU Slave or Modbus RTU Setpoint Broadcast Master.
Slave Address Range:	1 to 255.
Bit rate:	4800, 9600, 19200, 38400, 57600 or 115200 bps.
Bits per character:	10 or 11 (depending on parity setting) plus 1 Stop Bit
Parity:	None, even or odd (selectable).
Isolation:	240V reinforced safety isolation from all inputs and outputs.

Ethernet

Type:	Ethernet Communications Module.
Connection	Locates in Option Slot A. Connection via RJ45 connector on top of case.
Protocol:	Modbus TCP Slave only.
Supported Speed:	10BaseT or 100BaseT.
IP Address Allocation:	Via DHCP or manual configuration via PC Tool.
Isolation:	240V reinforced safety isolation from the supply, inputs and outputs (except SSR Drivers).

USB Socket

Targeted Peripheral:	USB Memory Stick.
Connection	Locates in Option Slot C. Connection via front mounted connector.
Protocol:	USB 1.1 or 2.0 compatible. Mass Storage Class.
Isolation:	Reinforced safety isolation from all inputs and outputs

Display

Display Type:	160 x 80 pixel, monochrome graphic LCD with a dual colour (red/green) backlight.
Display Area:	66.54mm (W) x 37.42mm (H).
Display Characters:	0 to 9, a to z, A to Z, plus () - and _
Trend View:	120 of 240 data points shown in a scrollable window. Data is not retained when power turned off or if time base is changed.
Trend View Data:	Displays any active alarm plus PV input (solid) & Setpoint (dotted) at sample time or Maximum & Minimum PV input value measured between samples (candle-stick graph).
Trend View Y-axis Scaling	The instrument automatically scales this between 2 to 100% of Input Span for maximum resolution of displayed data.
Trend View Sample Rate:	1; 2; 5; 10; 15; 30 seconds or 1; 2; 5; 10; 15; 30 minutes.

Control Loop

Tuning Types:	Pre-Tune, Auto Pre-Tune, Self-Tune and Manual Tuning
Proportional Bands:	Primary & Secondary (e.g. Heat & Cool) 0.5% to 999.9% of input span in 0.1% increments, or On/Off control.
Automatic Reset	Integral Time Constant, 1s to 99min 59s and OFF
Rate	Derivative Time Constant, 1s to 99 min 59s and OFF
Manual Reset	Bias added each control algorithm execution. Adjustable in the range 0 to 100% of output power (single output) or -100% to +100% of output power (dual output).
Deadband/Overlap:	-20% to +20% of Primary + Secondary Proportional Band.
ON/OFF Differential:	ON/OFF switching differential 0.1% to 10.0% of input span.
Auto/Manual Control:	Selectable with "bumpless" transfer when switching between Automatic and Manual control.
Control Cycle Times:	Selectable from 0.5 to 512 seconds in 0.1s steps.
Setpoint Range:	Limited by Setpoint Upper Limit and Setpoint Lower Limit.
Setpoint Maximum:	Limited by Scale Range Upper Limit and Setpoint Minimum.
Setpoint Minimum:	Limited by Scale Range Lower Limit and Setpoint Maximum.
Setpoint Ramp:	Ramp rate selectable 1 to 9999 LSD's per hour and infinite.

Data Recorder Option

Recording Memory:	1Mb non-volatile flash memory (<i>data retained when power is off</i>).
Recording Interval:	1; 2; 5; 10; 15; 30 seconds or 1; 2; 5; 10; 15; 30 minutes.
Recording Capacity:	Dependant on sample rate and number of values recorded. Example: 2 values can be recorded for 7 days at 10s intervals. More values or faster sample rates reduce the maximum duration.
RTC Battery Type:	VARTA CR 1616 3V Lithium. Clock runs for >1 year without power.
RTC accuracy:	Real Time Clock error <1second per day.

Profiler Option

Profile Limits:	Number of profiles = 64 maximum. <u>Total</u> number of segments (<i>all programs</i>) = 255 maximum.
Loop Back Segments:	1 to 9999 loops back to specified segment.
Profile Cycling:	1 to 9999 or Infinite repeats per profile.
Sequence Repeats:	1 to 9999 or Infinite repeats of joined profile sequences.
Segment Types:	Ramp Up/Down over time, Ramp Rate Up/Down, Step, Dwell, Hold, Join A Profile, End or Repeat Sequence Then End.
Time-base:	All times are specified in hh:mm:ss (Hours, Minutes & Seconds).
Segment Time:	Maximum segment time 99:59:59 hh:mm:ss. Use loop-back for longer segments (e.g. 24:00:00 x 100 loops = 100 days).
Ramp Rate:	0.001 to 9999.9 display units per hour.
Hold Segment Release:	Release With Key-press, At Time Of Day or via a Digital Input.
Start From Value:	1st segment starts from current setpoint or current PV input value.
Delayed Start:	After 0 to 99:59 (hh:mm) time delay, or at specified day(s) & time.
Profile End Action:	Selectable from: Keep Last Profile Setpoint, Use Controller Setpoint or Control Outputs Off.
Profile Abort Action:	Selectable from: Keep Last Profile Setpoint, Use Controller Setpoint or Control Outputs Off.
Power/signal Loss Recovery Action:	Selectable from: Continue Profile, Restart Profile, Keep Last Profile Setpoint, Use Controller Setpoint or Control Outputs Off.
Auto-Hold:	Off or Hold if input >Band above and/or below SP for each segment.
Profile Control:	Run, Manual Hold/Release, Abort or jump to next segment.
Profile Timing Accuracy:	0.02% Basic Profile Timing Accuracy. ±<0.5 second per Loop, End or Join segment.
Segment Events:	Events turn on for the duration of the segment. For End Segments, the event state persists until another profile starts or the unit is powered down.

Alarms

Maximum Number of Alarms:	Five "soft" alarms, each selectable for any of the supported alarm types. Physical outputs can be assigned for each alarm.
Alarm Types:	Process High, Process Low, Band, Deviation, Rate of Signal Change (per minute), Sensor/input Break, Loop Alarm. Band and Deviation (high or low) alarm values are relative to the current setpoint value.
Alarm Hysteresis:	Adjustable deadband from 1 LSD to full span (in display units) for Process, Band or Deviation Alarms. Rate Of Change Alarm hysteresis is the shortest time (1 to 9999 secs) the rate of change must be above the threshold for the alarm activate, or fall below the threshold to deactivate.
Combinatorial Alarms:	Logical OR of alarms 1 & 2, 1 to 3, 1 to 4 or 1 to 5 or Logical AND of alarms 1 to 5 with Profiler Events 1 to 5, to any suitable output.

Conditions For Use

Reference Test Conditions

Ambient Temperature:	20°C ±2°C.
Relative Humidity:	60 to 70%.
Supply Voltage:	100 to 240V AC 50Hz ±1%.
Source Resistance:	<10Ω for thermocouple input.
RTD Lead Resistance:	<0.1Ω/lead balanced (Pt100).

Operating Conditions

Ambient Temperatures	0°C to 55°C (operating) and -20°C to 80°C (storage).
Relative Humidity:	20% to 95% non-condensing.
Altitude:	Up to 2000m above sea level.
Supply Voltage:	Either 100 to 240V ±10% AC 50/60Hz or 20 to 48V AC 50/60Hz & 22 to 55V DC for low voltage versions.
Power Consumption:	Mains versions: 24VA. Low voltage versions: 15VA / 12W.
Source Resistance:	1000Ω maximum (thermocouple).
RTD Input Lead Resistance:	50Ω per lead maximum, balanced

Standards

Conformance Norms:	CE, UL, ULC.
EMC standards:	Complies with CE EN61326.
Safety Standards:	Complies with CE EN61010-1 and UL3121. Pollution Degree 2, Installation Category II.
Front Panel Sealing:	To IP66 (IP65 front USB connector). <i>IP20 behind the panel.</i> <i>(IP ratings are not tested for or approved by UL)</i>

Dimensions

Front Bezel Size:	1/4 DIN (96 x 96mm).
Mounting:	Plug-in with panel mounting fixing strap.
Panel Cut-out Size:	92mm x 92mm. Max panel thickness 6.0mm
Depth Behind Panel:	117mm
Ventilation	20mm gap required above, below and behind.
Weight:	0.65kg maximum.
Terminals:	Screw type (combination head).

18 Appendix 3 - Product Coding

Model Code	DCP20	-	x	-	x	-	x	-	x	-	x	-	x	-	x	-	x	-	x
USB/Recorder																			
Graphical Profiler	1																		
Graphical Profiler with USB Port	2																		
Graphical Profiler /Recorder with USB Port	3																		
Supply Voltage																			
100-240VAC	0																		
24-48V AC/DC	2																		
Option Slot 1																			
Not fitted	0																		
Relay Output	1																		
SSR Driver Output	2																		
Linear DC Output	L																		
Triac Output	8																		
Option Slot 2																			
Not fitted	0																		
Relay Output	1																		
SSR Driver Output	2																		
Linear DC Output	L																		
Triac Output	8																		
Dual Relay Output	9																		
Dual SSR Driver Output	S																		
24VDC Transmitter Power Supply	T																		
Option Slot 3																			
Not fitted	0																		
Relay Output	1																		
SSR Driver Output	2																		
Linear DC Output	L																		
Triac Output	8																		
Dual Relay Output	9																		
Dual SSR Driver Output	S																		
24VDC Transmitter Power Supply	T																		
Option Slot 4																			
Not fitted	0																		
4 Relay Output	1																		
Option Slot A																			
Not fitted	0																		
RS-485 Serial Communications	1																		
Digital Input 1	3																		
Aux Input A	4																		
Ethernet Port	5																		
Option Slot B																			
Not fitted	0																		
Aux Input B (including digital input 2)	R																		
Option Slot C																			
Not fitted	0																		
<i>Reserved</i>	1																		
HMI & Manual Language																			
English	1																		
French	2																		
German	3																		
Italian	4																		
Spanish	5																		
Russian	R																		

Honeywell contacts

ARGENTINA

HONEYWELL S.A.I.C.
BELGRANO 1156
BUENOS AIRES
ARGENTINA
Tel. : 54 1 383 9290

ASIA PACIFIC

HONEYWELL ASIA
PACIFIC Inc.
Room 3213-3225
Sun Kung Kai Centre
N° 30 Harbour Road
WANCHAI
HONG KONG
Tel. : 852 829 82 98

AUSTRALIA

HONEYWELL LIMITED
5 Thomas Holt Drive
North Ryde Sydney
NSW AUSTRALIA 2113
Tel. : 61 2 353 7000
AUSTRIA

HONEYWELL AUSTRIA

G.m.b.H.
Handelskai 388
A1020 VIENNA
AUSTRIA
Tel. : 43 1 727 800

BELGIUM

HONEYWELL S.A.
3 Avenue de Bourget
B-1140 BRUSSELS
BELGIUM
Tel. : 32 2 728 27 11

BRAZIL

HONEYWELL DO
BRAZIL
AND CIA
Rua Jose Alves Da
Chunha
Lima 172
BUTANTA
05360.050 SAO PAULO
SP
BRAZIL
Tel. : 55 11 819 3755

BULGARIA

HONEYWELL EOOD
14, Iskarsko Chausse
POB 79
BG- 1592 Sofia
BULGARIA
Tel : 359-791512/
794027/ 792198

CANADA

HONEYWELL LIMITED
THE HONEYWELL
CENTRE
300 Yorkland Blvd.
NORTH YORK,
ONTARIO
M2J 1S1
CANADA
Tel.: 800 461 0013
Fax:: 416 502 5001

CZECH

REPUBLIC
HONEYWELL, Spol.s.r.o.
Budejovicka 1
140 21 Prague 4
Czech Republic
Tel. : 42 2 6112 3434

DENMARK

HONEYWELL A/S
Automatikvej 1
DK 2860 Soeborg
DENMARK
Tel. : 45 39 55 56 58

FINLAND

HONEYWELL OY
Ruukintie 8
FIN-02320 ESPOO 32
FINLAND
Tel. : 358 0 3480101

FRANCE

HONEYWELL S.A.
Bâtiment « le Mercury »
Parc Technologique de St
Aubin
Route de l'Orme
(CD 128)
91190 SAINT-AUBIN
FRANCE
Tel. from France:
01 60 19 80 00
From other countries:
33 1 60 19 80 00

GERMANY

HONEYWELL AG
Kaiserleistrasse 39
D-63067 OFFENBACH
GERMANY
Tel. : 49 69 80 64444

HUNGARY

HONEYWELL Kft
Gogol u 13
H-1133 BUDAPEST
HUNGARY
Tel. : 36 1 451 43 00

ICELAND

HONEYWELL
Hataekni .hf
Armuli 26
PO Box 8336
128 reykvjavik
Iceland
Tel : 354 588 5000

ITALY

HONEYWELL S.p.A.
Via P. Gobetti, 2/b
20063 Cernusco Sul
Naviglio
ITALY
Tel. : 39 02 92146 1

MEXICO

HONEYWELL S.A. DE
CV
AV. CONSTITUYENTES
900
COL. LOMAS ALTAS
11950 MEXICO CITY
MEXICO
Tel : 52 5 259 1966

THE NETHERLANDS

HONEYWELL BV
Laaderhoogtweg 18
1101 EA AMSTERDAM
ZO
THE NETHERLANDS
Tel : 31 20 56 56 911

NORWAY

HONEYWELL A/S
Askerveien 61
PO Box 263
N-1371 ASKER
NORWAY
Tel. : 47 66 76 20 00

POLAND

HONEYWELL Sp.z.o.o
Ul Domainewksa 41
02-672 WARSAW
POLAND
Tel. : 48 22 606 09 00

PORTUGAL

HONEYWELL
PORTUGAL LDA
Edificio Suecia II
Av. do Forte nr 3 - Piso 3
2795 CARNAXIDE
PORTUGAL
Tel. : 351 1 424 50 00

REPUBLIC OF IRELAND

HONEYWELL
Unit 1
Robinhood Business
Park
Robinhood Road
DUBLIN 22
Republic of Ireland
Tel. : 353 1 4565944

REPUBLIC OF SINGAPORE

HONEYWELL PTE LTD
BLOCK 750E CHAI
CHEE ROAD
06-01 CHAI CHEE IND.
PARK
1646 SINGAPORE
REP. OF SINGAPORE
Tel. : 65 2490 100

REPUBLIC OF SOUTH AFRICA

HONEYWELL
Southern Africa
PO BOX 138
Milnerton 7435
REPUBLIC OF SOUTH
AFRICA
Tel. : 27 11 805 12 01

ROMANIA

HONEYWELL Office
Bucharest
147 Aurel Vlaicu Str.,
Sc.Z.,
Apt 61/62
R-72921 Bucharest
ROMANIA
Tel : 40-1 211 00 76/
211 79

RUSSIA

HONEYWELL INC
4 th Floor Administrative
Building of AO "Luzhniki"
Management
24 Luzhniki
119048 Moscow
RUSSIA
Tel : 7 095 796 98 00/01

SLOVAKIA

HONEYWELL Ltd
Mlynske nivky 73
PO Box 75
820 07 BRATISLAVA 27
SLOVAKIA
Tel. : 421 7 52 47 400/
425

SPAIN

HONEYWELL S.A
Factory
Josefa Valcarcel, 24
28027 MADRID
SPAIN
Tel. : 34 91 31 3 61 00

SWEDEN

HONEYWELL A.B.
S-127 86 Skarholmen
STOCKHOLM
SWEDEN
Tel. : 46 8 775 55 00

SWITZERLAND

HONEYWELL A.G.
Hertistrasse 2
8304 WALLISELLEN
SWITZERLAND
Tel. : 41 1 831 02 71

TURKEY

HONEYWELL
Otomasyon ve Kontrol
Sistemleri San ve Tic
A.S.
(Honeywell Turkey A.S.)
Emirhan Cad No 144
Barbaros Plaza C. Blok
Kat 18
Dikilitas 80700 Istanbul
TURKEY
Tel : 90-212 258 18 30

UNITED KINGDOM

HONEYWELL
Unit 1,2 & 4 Zodiac House
Calleva Park
Aldermaston
Berkshire RG7 8HW
UNITED KINGDOM
Tel : 44 118 906 2600

U.S.A.

HONEYWELL INC.
INDUSTRIAL PROCESS
CONTROLS
512 VIRGINIA DRIVE
PA 19034-3260
FT. WASHINGTON
U.S.A.
Tel. : 1-800-343-0228

VENEZUELA

HONEYWELL CA
APARTADO 61314
1060 CARACAS
VENEZUELA
Tel. : 58 2 239 0211

Free Manuals Download Website

<http://myh66.com>

<http://usermanuals.us>

<http://www.somanuals.com>

<http://www.4manuals.cc>

<http://www.manual-lib.com>

<http://www.404manual.com>

<http://www.luxmanual.com>

<http://aubethermostatmanual.com>

Golf course search by state

<http://golfingnear.com>

Email search by domain

<http://emailbydomain.com>

Auto manuals search

<http://auto.somanuals.com>

TV manuals search

<http://tv.somanuals.com>