

HEWLETT PACKARD

E4418A Power Meters

Programming Guide

1

Power Meter Remote Operation

Introduction

This chapter describes the parameters which configure the power meter and help you determine settings to optimize performance. It contains the following sections:

- “Configuring the Remote Interface”, on page 1-3.
- “Zeroing and Calibrating the Power Meter”, on page 1-8.
- “Making Measurements”, on page 1-11.
- “Using Sensor Calibration Tables”, on page 1-27.
- “Setting the Range, Resolution and Averaging”, on page 1-37.
- “Setting Offsets”, on page 1-41.
- “Setting Measurement Limits”, on page 1-43.
- “Measuring Pulsed Signals”, on page 1-46.
- “Triggering the Power Meter”, on page 1-49.
- “Getting the Best Speed Performance”, on page 1-54.
- “How Measurements are Calculated”, on page 1-58.
- “Status Reporting”, on page 1-59.
- “Saving and Recalling Power Meter Configurations”, on page 1-80.
- “Using Device Clear to Halt Measurements”, on page 1-81.
- “An Introduction to the SCPI Language”, on page 1-82.
- “Quick Reference”, on page 1-91.
- “SCPI Compliance Information”, on page 1-99.

Configuring the Remote Interface

This section describes how to configure the remote interface.





HP-IB Address

Each device on the HP-IB (IEEE-488) interface must have a unique address. You can set the power meter's address to any value between 0 and 30. The address is set to 13 when the power meter is shipped from the factory.

The address is stored in non-volatile memory, and does not change when the power meter is switched off, or after a remote interface reset.

Your HP-IB bus controller has its own address. Avoid using the bus controller's address for any instrument on the interface bus. Hewlett-Packard controllers generally use address 21.

To set the HP-IB address from the front panel:

1. Press , HP-IB. The current HP-IB address is displayed on the HP-IB Addr softkey.
2. To change this setting press HP-IB Addr. The power meter displays the address in a pop up window on the measurement screen. Modify this address (see below) as desired.
 - Use  or  to modify the digit on which the cursor is currently positioned.
 - Use  or  to move to other digits.
3. To confirm your choice press Enter.

To set the HP-IB address from the remote interface use the:

- `SYSTEM:COMMunicate:GPIB:ADDRESS` command.

To query the HP-IB address from the remote interface use the;

- `SYSTEM:COMMunicate:GPIB:ADDRESS?` query.

Programming Language Selection (HP EPM-441A only)

You can select one of two languages to program the power meter from the remote interface. The language is SCPI when the power meter is shipped from the factory. The other language is the HP 437B programming language.

The language selection is stored in non-volatile memory, and does not change when power has been off or after a remote interface reset.

To select the interface language from the front panel:

1. Press , HP=IB , Command Set .
2. Select the language you require from HP 437B and SCPI .

To select the interface language from the remote interface use the:

- SYSTem:LANGuage command.

To query the interface language from the remote interface use the:

- SYSTem:LANGuage? query.

Table 1-1 details all the HP 437B commands that the HP EPM-441A supports and their function. For a detailed description of these commands refer to the *HP 437B Power Meter Operating Manual*. In addition the SYST:LANG SCPI command allows you to return to using the SCPI programming language when in the HP 437B mode.

Table 1-1: HP 437B Command Summary

Command	Description
CL	Calibrate
*CLS	Clear all status registers
CS	Clear the status byte
CT	Clear sensor table
DA ¹	All display segments on
DC0	Duty Cycle off
DC1	Duty Cycle on
DD	Display disable
DE	Display enable
DF	Display enable
DN ¹	Down arrow key
DU ¹	Display user message
DY	Enter duty cycle
EN	Enter
ERR?	Device error query
*ESR?	Event status register query
*ESE	Set event status register mask
*ESE?	Event status register mask query
ET	Edit sensor table
EX	Exit
FA	Automatic filter selection
FH	Filter hold
FM	Manual filter selection
FR	Enter measurement frequency
GT0	Ignore GET bus command
GT1	Trigger immediate response to GET
GT2	Trigger with delay response to GET
GZ	Gigahertz
HZ	Hertz
ID	Identification query
*IDN?	Identification query
KB	Enter measurement cal factor

Power Meter Remote Operation
Configuring the Remote Interface

Command	Description
KZ	Kilohertz
LG	Log units (dBm/dB)
LH	Enter high (upper) limit
LL	Enter low (lower) limit
LM0	Disable limits checking
LM1	Enable limits checking
LN	Linear units (watts/%)
LP2	Learn mode
LT ¹	Left arrow key
MZ	Megahertz
OC0	Reference oscillator off
OC1	Reference oscillator on
OD	Output display
OF0	Offset off
OF1	Offset on
OS	Enter offset value
PCT	Percent
PR	Preset
RA	Auto range
RC	Recall instrument configuration
RE	Set display resolution
RF	Enter sensor table reference calibration factor
RH	Range hold
RL0	Exit from relative mode
RL1	Enter relative mode (take new reference)
RL2	Enter relative mode (use last reference)
RM	Set measurement range
*RST	Reset
RT ¹	Right arrow key
RV	Read service request mask
SE	Select sensor calibration table
SM	Status message
SN	Enter sensor identification/serial number

Power Meter Remote Operation
Configuring the Remote Interface

Command	Description
SP ¹	Special
SPD 20 40 ²	
*SRE	Set the service request mask
*SRE?	Service request mask query
ST	Store (save) power meter configuration
*STB?	Read status byte
SYST:LANG SCPI ³	Selects SCPI language
TR0	Trigger hold
TR1	Trigger immediate
TR2	Trigger with delay
TR3	Trigger free run
*TST? ⁴	Self test query
UP ¹	Up arrow key
ZE	Zero
@1	Prefix for status mask
@2	Learn mode prefix
%	Percent

1. This command is accepted but has no active function.
2. This command is not an original HP 437B command. However, it can be used to set the measurement speed to 20 or 40 readings/sec in HP 437B mode. See SENSE:SPEED for more details.
3. This command is not an original HP 437B command. However, it can be used to terminate the HP 437B language and select the SCPI language. Note that it is recommended that the instrument is Preset following a language switch.
4. Always returns 0000 in HP 437B language.

Zeroing and Calibrating the Power Meter

This section describes how to zero and calibrate the power meter.

The calibration and zeroing commands are overlapped commands refer to “Using the Operation Complete Commands”, on page 1-78 to determine when the commands are complete.

Zeroing

Zeroing adjusts the power meter’s specified channel for a zero power reading with no power applied to the power sensor.

The command used to zero the power meter is:

```
CALibration[1|2]:ZERO:AUTO ONCE
```

The command assumes that there is no power being applied to the sensor. It turns the power reference oscillator off, then after zeroing, returns the power reference oscillator to the same state it was in prior to the command being received. Zeroing takes approximately 10 seconds depending on the type of power sensor being used.

When to Zero?

Zeroing of the power meter is recommended:

- when a 5⁰C change in temperature occurs.
- when you change the power sensor.
- every 24 hours.
- prior to measuring low level signals. For example, 10 dB above the lowest specified power for your power sensor.

Calibration

Calibration sets the gain of the power meter using a 50 MHz 1 mW calibrator as a traceable power reference. The power meter’s POWER REF output or a suitable external reference is used as the signal source for calibration. An essential part of calibrating is setting the correct reference calibration factor for the power sensor you are using. The HP 8480 series power sensors require you to set the reference calibration factor. The HP E-series power sensors set the reference calibration factor

automatically. Offset, relative and duty cycle settings are ignored during calibration.

The command used to calibrate the power meter is:

```
CALibration[1|2]:AUTO ONCE
```

The command assumes that the power sensor is connected to a 1 mW reference signal. It turns the power reference oscillator on, then after calibrating, returns the power reference oscillator to the same state it was in prior to the command being received. It is recommended that you zero the power meter before calibrating.

Calibration Sequence

This feature allows you to perform a complete calibration sequence with a single query. The query is:

```
CALibration[1|2][:ALL]?
```

The query assumes that the power sensor is connected to the power reference oscillator. It turns the power reference oscillator on, then after calibrating, returns the power reference oscillator to the same state it was in prior to the command being received. The calibration sequence consists of:

- Zeroing the power meter (CALibration[1|2]:ZERO:AUTO ONCE), and
- calibrating the power meter (CALibration[1|2]:AUTO ONCE).

The query enters a number into the output buffer when the sequence is complete. If the result is 0 the sequence was successful. If the result is 1 the sequence failed. Refer to "CALibration[1|2][:ALL]?", on page 4-5 for further information.

Note

The CALibration[1|2][:ALL] command is identical to the CALibration[1|2][:ALL]? query except that no number is returned to indicate the outcome of the sequence. You can examine the Questionable Status Register or the error queue to discover if the sequence has passed or failed. Refer to "Status Reporting", on page 1-59 for further information.

Setting the Reference Calibration Factor

All the HP 8480 series power sensors require you to set the reference calibration factor. The reference calibration factor can be set by:

- entering the value into the power meter using the `CALibrate[1|2]:RCFactor` command.
- selecting and enabling the sensor calibration table. The reference calibration factor is automatically set by the power meter using the reference calibration factor stored in the sensor calibration table. See “Using Sensor Calibration Tables”, on page 1-27 for further information.

Examples

- a) To enter a reference calibration factor of 98.7% for channel A, you should use the following command :

```
CAL:RCF 98.7PCT
```

This overrides any RCF previously set by selecting a sensor calibration table.

- b) To automatically set the reference calibration factor, you have to use a sensor calibration table as described in “Using Sensor Calibration Tables”, on page 1-27. To select and enable the table d use the following commands:

```
[SENSe[1]]|SENSe2:CORRection:CSET:SElect <string>  
[SENSe[1]]|SENSe2:CORRection:CSET:STATe ON
```

When the sensor calibration table is selected the RCF from the table overrides any value previously set.

Querying the Reference Calibration Factor

To determine the current reference calibration factor, use the following command:

```
CALibration[1|2]:RCFactor?
```

Making Measurements

The `MEASure?` and `CONFigure` commands provide the most straight-forward method to program the power meter for measurements. You can select the measurement's expected power level, resolution and with the HP EPM-442A the measurement type (that is single channel, difference or ratio measurements) all in one command. The power meter automatically presets other measurement parameters to default values as shown in Table 1-2.

Table 1-2: MEASure? and CONFigure Preset States

Command	MEASure? and CONFigure Setting
Trigger source (<code>TRIGger:SOURce</code>)	Immediate
Filter (<code>SENSe:AVERAge:COUNT:AUTO</code>)	On
Filter state (<code>SENSe:AVERAge:STATe</code>)	On
Trigger cycle (<code>INITiate:CONTinuous</code>)	Off
Trigger Delay (<code>TRIGger:DELay:AUTO</code>)	On

An alternative method to program the power meter is to use the lower level commands. The advantage of using the lower level commands over the `CONFigure` command is that they give you more precise control of the power meter. As shown in Table 1-2 the `CONFigure` command presets various states in the power meter. It may be likely that you do not want to preset these states. Refer to "Using the Lower Level Commands", on page 1-26 for further information.

Using MEASure?

The simplest way to program the power meter for measurements is by using the MEASure? query. However, this command does not offer much flexibility. When you execute the command, the power meter selects the best settings for the requested configuration and immediately performs the measurement. You cannot change any settings (other than the expected power value, resolution and with the HP EPM-442A the measurement type) before the measurement is taken. This means you cannot fine tune the measurement, for example, you cannot change the filter length. To make more flexible and accurate measurements use the CONFIGure command. The measurement results are sent to the output buffer. MEASure? is a compound command which is equivalent to an ABORT, followed by a CONFIGure, followed by a READ?.

MEASure? Examples

The following commands show a few examples of how to use the MEASure? query to make a measurement. It is advisable to read through these examples in order as they become increasingly more detailed. These examples configure the power meter for a measurement (as described in each individual example), automatically place the power meter in the “wait-for-trigger” state, internally trigger the power meter to take one reading, and then sends the reading to the output buffer.

These examples give an overview of the MEASure? query. For further information on the MEASure? commands refer to the section “MEASure[1|2] Commands” starting on page 2-49 .

Example 1 - The Simplest Method

The following commands show the simplest method of making single channel (for example A or B) measurements. Using MEAS1? will result in an upper window measurement, and MEAS2? in a lower window measurement. The channel associated with the window can be set using the source list parameter (see example 2), or will default as in this example (See “HP EPM-442A only” on page 15.).

specifies window

↓
MEAS1?
MEAS2?

Example 2 - Specifying the Source List Parameter

The MEASure command has three optional parameters, an expected power value, a resolution and a source list. These parameters must be entered in the specified order. If parameters are omitted, they will default from the right. The parameter DEFault is used as a place holder.

The following example uses the source list parameter to specify the measurement channel as channel A. The expected power and resolution parameters are defaulted, leaving them at their current settings. The measurement is carried out on the upper window.

specifies window specifies channel
↓ ↓
MEAS1? DEF,DEF, (@1)

The operation of the MEAS1? command when the source list parameter is defaulted is described in the note on page 1-15.

Note

For the HP EPM-441A it is not necessary to specify a channel as only one channel is available.

Example 3 - Specifying the Expected Power Parameter

The previous example details the three optional parameters which can be used with the MEASure? command. The first optional parameter is used to enter an expected power value. Entering this parameter is only relevant if you are using an HP E-series power sensor. The value entered determines which of the power sensor's two ranges is used for the measurement. If the current setting of the power sensor's range is no longer valid for the new measurement, specifying the expected power value decreases the time taken to obtain a result.

The following example uses the expected value parameter to specify a value of -50 dBm. This selects the power sensor's lower range (refer to "Range", on page 1-37 for details of the range breaks). The resolution parameter is defaulted, leaving it at its current setting. The source list parameter specifies a channel B measurement. The measurement is displayed on the lower window.

specifies expected power value
specifies window ↓ specifies channel
↓ ↓ ↓
MEAS2? -50,DEF, (@2)

Power Meter Remote Operation
Making Measurements

Command	Current Window Setup	Measurement
MEAS2:POW:AC:RAT	Lower Window: A/B	A/B
	B/A	B/A
	Any Other	A/B
MEAS1:POW:AC:DIFF?	Upper Window: A-B	A-B
	B-A	B-A
	Any Other	A-B
MEAS2:POW:AC:DIFF?	Lower Window: A-B	A-B
	B-A	B-A
	Any Other	A-B

Using the CONFigure Command

When you execute this command, the power meter presets the best settings for the requested configuration (like the MEASure? query). However, the measurement is not automatically started and you can change measurement parameters before making measurements. This allows you to incrementally change the power meter's configuration from the preset conditions. The power meter offers a variety of low-level commands in the SENSE, CALCulate, and TRIGger subsystems. For example, if you want to change the averaging use the [SENSE[1]] | SENSE2: AVERage: COUNT command.

Use the INITiate or READ? query to initiate the measurement.

Using READ?

CONFigure does not take the measurement. One method of obtaining a result is to use the READ? query. The READ? query takes the measurement using the parameters set by the CONFigure command then sends the reading to the output buffer. Using the READ? query will obtain new data.

Using INITiate and FETCh?

CONFigure does not take the measurement. One method of obtaining the result is to use the INITiate and FETCh? commands. The INITiate command causes the measurement to be taken. The FETCh? query retrieves a reading when the measurement is complete, and sends the reading to the output buffer. FETCh? can be used to display the measurement results in a number of different formats (for example, A/B and B/A) without taking fresh data for each measurement.

CONFigure Examples

The following program segments show how to use the READ? command and the INITiate and FETCh? commands with CONFigure to make measurements.

It is advisable to read through these examples in order as they become increasingly more detailed.

These examples give an overview of the CONFigure command. For further information on the CONFigure commands refer to Chapter 2, "MEASurement Instructions".

Power Meter Remote Operation
Making Measurements

Example 1 - The Simplest Method

The following program segments show the simplest method of querying the upper and lower window's measurement results respectively.

Using READ?

```
*RST      Reset instrument
CONF1     Configure upper window - defaults to a channel A
           measurement
READ1?    Take upper window (channel A) measurement

*RST      Reset instrument
CONF2     Configure the lower window - defaults to channel A
           (HP EPM-441A), Channel B (HP EPM-442A) measurement
READ2?    Take lower window measurement (channel A on
           HP EPM-441A, B on HP EPM-442A)
```

Using INITiate and FETCh?

```
*RST      Reset instrument
CONF1     Configure upper window - defaults to a channel A
           measurement
INIT1     Causes channel A to make a measurement
FETC1?    Retrieves the upper window's measurement
```

For the HP EPM -441A only:

```
*RST      Reset instrument
CONF2     Configure lower window - HP EPM-441A defaults to channel A
INIT1?    Causes channel A to make measurement
FETC2?    Retrieves the lower window's measurement
```

For the HP EPM-442A only:

```
*RST      Reset instrument
CONF2     Configure lower window
INIT2?    Causes channel B to make measurement
FETC2?    Retrieves the lower window's measurement
```

Example 2 - Specifying the Source List Parameter

The `CONFigure` and `READ?` commands have three optional parameters, an expected power value, a resolution and a source list. These parameters must be entered in the specified order. If parameters are omitted, they will default from the right. The parameter `DEFault` is used as a place holder.

The following examples use the source list parameter to specify the measurement channel as channel A. The expected power and resolution parameters are defaulted, leaving them at their current settings. The measurement is carried out on the upper window.

Although the `READ?` and `FETCH?` queries have three optional parameters it is not necessary to define them as shown in these examples. If they are defined they must be identical to those defined in the `CONFigure` command otherwise an error occurs.

Note For the HP EPM-441A it is not necessary to specify a channel as only one channel is available.

Using `READ?`

<code>ABOR1</code>	<i>Aborts channel A</i>
<code>CONF1 DEF,DEF, (@1)</code>	<i>Configures the upper window to make a channel A measurement using the current expected power and resolution settings.</i>
<code>READ1?</code>	<i>Takes the upper window's measurement.</i>

Using `INITiate` and `FETCH?`

<code>ABOR1</code>	<i>Aborts channel A</i>
<code>CONF1 DEF,DEF, (@1)</code>	<i>Configures the upper window to make a channel A measurement using the current expected power and resolution settings.</i>
<code>INIT1</code>	<i>Causes channel A to make a measurement.</i>
<code>FETCH1?</code>	<i>Retrieves the upper window's measurement.</i>

Example 3 - Specifying the Expected Power Parameter

The previous example details the three optional parameters which can be used with the CONFigure and READ? commands. The first optional parameter is used to enter an expected power value. Entering this parameter is only relevant if you are using an HP E-series power sensor. The value entered determines which of the power sensor's two ranges is used for the measurement. If the current setting of the power sensor's range is no longer valid for the new measurement, specifying the expected power value decreases the time taken to obtain a result.

The following example uses the expected value parameter to specify a value of -50 dBm. This selects the power meter's lower range (refer to "Range", on page 1-37 for details of the range breaks). The resolution parameter is defaulted, leaving it at its current setting. The source list parameter specifies a channel B measurement. The measurement is carried out on the upper window.

Using READ?

```
ABOR2  
CONF1 -50,DEF,(@2)
```

*Aborts channel B
Configures the upper window to
make a channel B measurement
using an expected power of
-50 dBm and the current
resolution setting.*

```
READ1?
```

*Takes the upper window's
measurement.*

Some fine tuning of measurements can be carried out using the CONFigure and READ? commands. For example, in the above program segment some fine tuning can be carried out by setting the filter length to 1024 and the trigger delay off.

```
ABOR2  
CONF1 -50,DEF,(@2)  
SENS2:AVER:COUN 1024  
TRIG2:DEL:AUTO OFF  
READ1?
```

Using INITiate and FETCh?

ABOR2	<i>Aborts channel B</i>
CONF1 -50,DEF,(@2)	<i>Configures the upperwindow to make a channel B measurement using an expected power of -50 dBm and the current resolution setting.</i>
INIT2	<i>Causes channel B to make a measurement.</i>
FETC1?	<i>Retrieves the upper window's measurement.</i>

Some fine tuning of measurements can be carried out using the CONFigure command and INITiate and FETCh? commands. For example, in the above program segment some fine tuning can be carried out by setting the filter length to 1024 and the trigger delay off.

```
ABOR2
CONF1 -50,DEF,(@2)
SENS2:AVER:COUN 1024
TRIG2:DEL:AUTO OFF
INIT2
FETC1?
```

Example 4 - Specifying the Resolution Parameter

The previous examples detailed the use of the expected value and source list parameters. The resolution parameter is used to set the resolution of the specified window. This parameter does not affect the resolution of the HP-IB data, however it does affect the auto averaging setting (refer to Figure 1-2 on page 1-39).

Since the filter length used for a channel with auto-averaging enabled is dependent on the window resolution setting, a conflict arises when a given channel is set up in both windows and the resolution settings are different. In this case, the higher resolution setting is used to determine the filter length.

The following example uses the resolution parameter to specify a resolution setting of 3. This setting represents 3 significant digits if the measurement suffix is W or %, and 0.01 dB if the suffix is dB or dBm (for further details on the resolution parameter refer to the commands in Chapter 2, "MEASurement Instructions"). Also, in this example the expected power and source list parameters are defaulted. The expected power value will be left unchanged at its current setting. The source list parameter will be defaulted as described in the note on page 1-15. Note that as the source list parameter is the last specified parameter you do not have to specify DEF.

Using READ?

ABOR1	<i>Aborts channel A.</i>
CONF1 DEF, 3	<i>Configures the upper window to make a measurement using the current setting of the expected power and source list and a resolution setting of 3.</i>
READ1?	<i>Takes the upper window's measurement. This will be a channel A or B measurement depending on current window setup</i>

Some fine tuning of the above program segment can be carried out for example, by setting the trigger delay off. The following program segment assumes that channel A is currently being measured on the upper window.

```
ABOR1
CONF1 DEF, 3
TRIG1:DEL:AUTO OFF
READ1?
```

Using INITiate and FETCh?

The following program segment assumes that channel A is currently being measured on the upper window.

ABOR1	<i>Aborts channel A.</i>
CONF1 DEF, 3	<i>Configures the upper window to make a measurement using the current setting of the expected power and source list and a resolution setting of 3.</i>
INIT1	<i>Causes channel A to make a measurement.</i>
FETC1?	<i>Retrieves the upper window's measurement.</i>

Some fine tuning of the above program segment can be carried out for example, by setting the trigger delay off.

```
ABOR1
CONF1 DEF, 3
TRIG1:DEL:AUTO OFF
INIT1:IMM
FETC1?
```

Power Meter Remote Operation
Making Measurements

Example 5 - Making a Difference Measurement

The following program segment can be carried out on the HP EPM-442A. It queries the lower window to make a difference measurement of channel A - channel B. The expected power level and resolution parameters are defaulted, leaving them at their current settings. Some fine tuning of the measurement is carried out by setting the averaging, and the trigger delay to off.

Using READ?

```
ABOR1
ABOR2
CONF2:POW:AC:DIFF DEF,DEF,(@1),(@2)
SENS1:AVER:COUN 1024
SENS2:AVER:COUN 1024
TRIG1:DEL:AUTO OFF
TRIG2:DEL:AUTO OFF
READ2:POW:AC:DIFF?
READ2:POW:AC:DIFF? DEF,DEF,(@2),(@1) (A second READ? query is
sent to make a channel B - channel A measurement using fresh
measurement data.)
```

Using INITiate and FETCh?

```
ABOR1
ABOR2
CONF2:POW:AC:DIFF DEF,DEF,(@1),(@2)
SENS1:AVER:COUN 1024
SENS2:AVER:COUN 1024
TRIG1:DEL:AUTO OFF
TRIG2:DEL:AUTO OFF
INIT1:IMM
INIT2:IMM
FETC2:POW:AC:DIFF?
FETC2:POW:AC:DIFF? DEF,DEF,(@2),(@1) (A second FETCh? query is
sent to make a channel B - channel A measurement using the current
measurement data.)
```

Example 6 - Making a Ratio Measurement

The following program segment can be carried out on the HP EPM-442A. It queries the lower window to make a ratio measurement of channel A/B. The expected power level and resolution parameters are defaulted, leaving them at their current settings. Some fine tuning of the measurement is carried out by setting the averaging.

Using READ?

```
ABOR1
ABOR2
CONF2:POW:AC:RAT DEF,DEF, (@1), (@2)
SENS1:AVER:COUN 512
SENS2:AVER:COUN 256
READ2:POW:AC:RAT?
READ2:POW:AC:RAT? DEF,DEF, (@2), (@1) (A second READ? query is sent to make a channel B - channel A ratio measurement using fresh measurement data.)
```

Using INITiate and FETCh?

```
ABOR1
ABOR2
CONF2:POW:AC:RAT DEF,DEF, (@1), (@2)
SENS1:AVER:COUN 512
SENS2:AVER:COUN 256
INIT1:IMM
INIT2:IMM
FETC2:POW:AC:RAT?
FETC2:POW:AC:RAT? DEF,DEF, (@2), (@1) (A second FETCh? query is sent to make a channel B - channel A measurement using the current measurement data.)
```

Using the Lower Level Commands

An alternative method of making measurements is to use the lower level commands to set up the expected range and resolution. This can be done using the following commands:

```
[SENSe[1]] | SENSe2:POWER:AC:RANGE  
DISPlay[:WINDow[1|2]]:RESolution
```

The measurement type can be set using the following commands in the CALCulate subsystem:

```
CALCulate[1|2]:MATH[:EXPRession]  
CALCulate[1|2]:RELative[:MAGNitude]
```

The advantage of using the lower level commands over the CONFIGure command is that they give you more precise control of the power meter. As shown in Table 1-2 on page 1-11 the CONFIGure command presets various states in the power meter. It may be likely that you do not want to preset these states.

Example

The following example sets the expected power value to -50 dBm and the resolution setting to 3 using the lower level commands. The measurement is a single channel A measurement carried out on the lower window.

ABOR1	<i>Aborts channel A.</i>
CALC2:MATH:EXPR "(SENS1)"	<i>Displays channel A on lower window.</i>
SENS1:POW:AC:RANG 0	<i>Sets lower range (E-series sensors only).</i>
DISP:WIND2:RES 3	<i>Sets the lower window's resolution to setting 3.</i>
INIT1	<i>Causes channel A to make a measurement.</i>
FETC2?	<i>Retrieves the lower window's measurement.</i>

Using Sensor Calibration Tables

This section applies to all HP 8480 series power sensors. It does not apply to the HP E-series power sensors. The HP E-series power sensors have their sensor calibration tables stored in EEPROM which allows frequency and calibration factor data to be downloaded by the power meter automatically.

This section describes how to use sensor calibration tables. Sensor calibration tables are used to store the measurement calibration factors, supplied with each power sensor, in the power meter. These calibration factors are used to correct measurement results.

Overview

For the HP 8480 series power sensors there are two methods of providing correction data to the power meter depending on the setting of the [SENSE[1]]|SENSE2:CORREction:CSET:STATE command. If [SENSE[1]]|SENSE2:CORREction:CSET:STATE is OFF the sensor calibration tables are not used. To make a calibrated power measurement when [SENSE[1]]|SENSE2:CORREction:CSET:STATE is OFF, perform the following steps:

1. Zero and calibrate the power meter. Before carrying out the calibration set the reference calibration factor for the power meter you are using.
2. Set the calibration factor to the value for the frequency of the signal you want to measure.
3. Make the measurement.

When [SENSE[1]]|SENSE2:CORREction:CSET:STATE is ON, the sensor calibration tables are used, providing you with a quick and convenient method for making power measurements at a range of frequencies using one or more power sensors. Note that with the sensor calibration table selected, the RCF from the table overrides any value previously set. The power meter is capable of storing 20 sensor calibration tables of 80 frequency points each.

Power Meter Remote Operation
Using Sensor Calibration Tables

Figure 1-1 illustrates how sensor calibration tables operate.

Figure 1-1: Sensor Calibration Tables

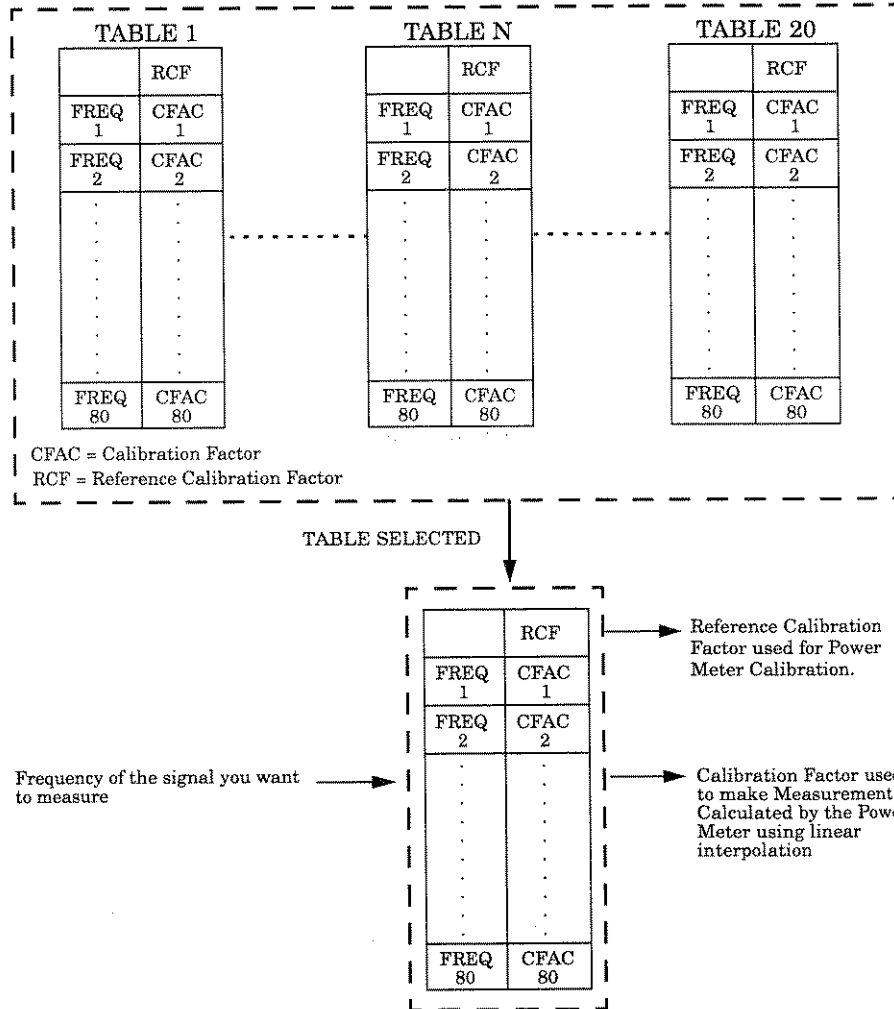

To use sensor calibration tables you:

1. Edit a sensor calibration table if necessary.
2. Select the sensor calibration table.
3. Enable the sensor calibration table.
4. Zero and calibrate the power meter. The reference calibration factor used during the calibration is automatically set by the power meter from the sensor calibration table.
5. Specify the frequency of the signal you want to measure. The calibration factor is automatically set by the power meter from the sensor calibration table.
6. Make the measurement.

Editing Sensor Calibration Tables

It is not possible to create any additional sensor calibration tables. However, the 20 existing ones can be edited using the `MEMory` subsystem. To do this:

1. Select one of the existing tables using:
`MEMory:TABLE:SElect <string>`.
For information on naming sensor calibration tables see “Naming Sensor Calibration Tables”, on page 1-33. For information on the current names which you can select refer to “Listing the Sensor Calibration Table Names”, on page 1-31.
2. Enter the frequency data using:
`MEMory:TABLE:FREquency <numeric_value> {,<numeric_value>}`
3. Enter the calibration factors using:
`MEMory:TABLE:GAIN <numeric_value> {,<numeric_value>}`. The first parameter you enter should be the reference calibration factor, each subsequent parameter is a calibration factor in the sensor calibration table. This means that entries in the frequency list correspond as shown with entries in the calibration factor list.

Frequency	Calibration Factor
	Reference Calibration Factor
Frequency 1	Calibration Factor 1
Frequency 2	Calibration Factor 2
"	"
Frequency n	Calibration Factor n

4. If required, rename the sensor calibration table using:
`MEMory:TABLE:MOVE <string>,<string>`. The first `<string>` parameter identifies the existing table name, and the second identifies the new table name.

Note

The legal frequency suffix multipliers are any of the IEEE suffix multipliers, for example, KHZ, MHZ and GHZ. If no units are specified the power meter assumes the data is Hz.

PCT is the only legal unit for calibration factors and can be omitted.

The frequency and calibration data must be within range. Refer to the individual commands in Chapter 4 for their specified ranges.

The number of calibration factor points must be one more than the number of frequency points. This is verified when the sensor calibration table is selected using

```
[SENSe[1]] | SENSe2:CORRection:CSET[:SElect] <string>.
```

Ensure that the frequency points you use cover the frequency range of the signals you want to measure. If you measure a signal with a frequency outside the frequency range defined in the sensor calibration table, then the power meter uses the highest or lowest frequency point in the sensor calibration table to calculate the calibration factor.

To make subsequent editing of a sensor calibration table simpler, it is recommended that you retain a copy of your data in a program.

Listing the Sensor Calibration Table Names

To list the sensor calibration tables currently stored in the power meter, use the following command:

```
MEMory:CATalog:TABLE?
```

The power meter returns the data in the form of two numeric parameters and 20 strings representing the stored sensor calibration tables.

- `<numeric_value>, <numeric_value>{, <string>}`
The first numeric parameter indicates the amount of memory, in bytes, used for storage of sensor calibration tables. The second parameter indicates the memory, in bytes, available for sensor calibration tables.

Power Meter Remote Operation Using Sensor Calibration Tables

Each string parameter returned indicates the name, type and size of a stored sensor calibration table:

- `<string>`, `<type>`, `<size>`
The `<string>`, `<type>` and `<size>` are all character data. The `<type>` is always `TABL`. The `<size>` is displayed in bytes.

For example, a sample of the response may look like:

```
560,8020,"Sensor_1,TABL,220","Sensor_2,TABL,340" ....
```

The power meter is shipped with a set of predefined sensor calibration tables. The data in these sensor calibration tables is based on statistical averages for a range of Hewlett-Packard Power Sensors (see Chapter 2, "Editing Sensor Calibration Tables" in the User's Guide). These power sensors are:

- DEFAULT¹
- HP 8481A
- HP 8482A²
- HP 8483A
- HP 8481D
- HP 8485A
- R8486A
- Q8486A
- R8486D
- HP 8487A

For further information on naming sensor calibration tables see "Naming Sensor Calibration Tables", on page 1-33.

1. DEFAULT is a sensor calibration table in which the reference calibration factor and calibration factors are 100%. This sensor calibration table can be used during the performance testing of the power meter.
2. The HP 8482B and HP 8482H power sensors use the same data as the HP 8482A.

Naming Sensor Calibration Tables

To rename a sensor calibration table use:

```
MEMory:TABLE:MOVE <string>,<string>
```

The first <string> parameter identifies the existing table name, and the second identifies the new table name.

The following rules apply to sensor calibration table names:

- a) The sensor calibration table must consist of no more than 12 characters.
- b) All characters must be upper or lower case alphabetic characters, or numeric (0-9), or an underscore (_).
- c) No spaces are allowed in the name.

Reviewing Table Data

To review the data stored in a sensor calibration table, use the following commands:

- `MEMory:TABLE:SElect "Sense1"`
Select the sensor calibration table named "Sense1".
- `MEMory:TABLE:SElect?`
Query command which returns the name of the currently selected table.
- `MEMory:TABLE:FREquency:POINTs?`
Query command which returns the number of stored frequency points.
- `MEMory:TABLE:FREquency?`
Query command which returns the frequencies stored in the sensor calibration table (in Hz).
- `MEMory:TABLE:GAIn[:MAGNitude]:POINTs?`
Query command which returns the number of calibration factor points stored in the sensor calibration table.
- `MEMory:TABLE:GAIn[:MAGNitude]?`
Query command which returns the calibration factors stored in the sensor calibration table. The first point returned is the reference calibration factor.

Modifying Data

If you need to modify the frequency and calibration factor data stored in a sensor calibration table you need to resend the complete data lists. There are two ways to do this:

1. If you have retained the original data in a program, edit the program and resend the data.
2. Use the query commands shown in "Reviewing Table Data", on page 1-34 to enter the data into your computer. Edit this data, then resend it.

Selecting a Sensor Calibration Table

After you have created the sensor calibration table, you can select it using the following command:

```
[SENSe[1]] | SENSE2:CORRection:CSET[:SElect] <string>
```

When the table is selected, the power meter verifies the number of calibration factor points defined in the sensor calibration table is one parameter greater than the number of frequency points. If this is not the case an error occurs.

To find out which sensor calibration table is currently selected, use the query:

```
[SENSe[1]] | SENSE2:CORRection:CSET[:SElect]?
```

Enabling the Sensor Calibration Table System

To enable the sensor calibration table, use the following command:

```
[SENSe[1]] | SENSE2:CORRection:CSET:STATe ON
```

If you set `[SENSe[1]] | SENSE2:CORRection:CSET:STATe` to ON and no sensor calibration table is selected error -221, "Settings conflict" occurs.

Making the Measurement

To make the power measurement, set the power meter for the frequency of the signal you want to measure. The power meter automatically sets the calibration factor. Use either the `INITiate`, `FETCh?` or the `READ?` query to initiate the measurement as shown in the following program segments:

INITiate Example

```
ABORT1  
CONFigure1:POWer:AC DEF,1,(@1)  
SENS1:CORR:CSET:SEL "HP8481A"  
SENS1:CORR:CSET:STAT ON  
SENSE1:FREQuency 500KHZ  
INITiate1:IMMediate  
FETCh1?
```

READ? Example

```
ABORT1  
CONFigure1:POWer:AC DEF,2,(@1)  
SENS1:CORR:CSET:SEL "HP8481A"  
SENS1:CORR:CSET:STAT ON  
SENSE1:FREQuency 500KHZ  
READ1?
```

Note

If the measurement frequency does not correspond directly to a frequency in the sensor calibration table, the power meter calculates the calibration factor using linear interpolation.

If you enter a frequency outside the frequency range defined in the sensor calibration table, then the power meter uses the highest or lowest frequency point in the sensor calibration table to set the calibration factor.

To find out the value of the calibration factor being used by the power meter to make a measurement, use the query command: `[SENSe[1]]|SENSe2:CORRection:CFAC?` The response may be an interpolated value.

To find out the value of the reference calibration factor being used, use the commands:
`CALibration[1|2]:RCFactor?`

Setting the Range, Resolution and Averaging

This section provides an overview of setting the range, resolution and averaging. For more detailed information about these features refer to the individual commands in Chapter 9.

Range

The power meter has no internal ranges which can be set. The only ranges that can be set are those of the HP E-series power sensors. With an HP E-series power sensor the range can be set either automatically or manually. Use autoranging when you are not sure of the power level you will be measuring.

Setting the Range

To set the range manually use the following command:

```
[SENSe[1]]|SENSe2:POWer:AC:RANGe <numeric_value>
```

If the <numeric_value> is set to:

- 0, the sensor's lower range is selected. (For example, this range is -70 to -13.5 dBm for the HP ECP-18A power sensor.)
- 1, the sensor's upper range is selected. (For example, this range is -14.5 to +20 dBm for the HP ECP-18A power sensor.)

For details on the range limits of other HP E-series power sensors refer to the appropriate power sensor manual.

For further information on this command refer to page 9-48.

To enable autoranging use the following command:

```
[SENSe[1]]|SENSe2:POWer:AC:RANGe:AUTO ON
```

Use autoranging when you are not sure of the power level you will be measuring.

Resolution

You can set the window's resolution using the following command:

```
DISPlay[:WINDow[1|2]]:RESolution <numeric_value>
```

There are four levels of resolution available (1 through 4).

When the measurement suffix is W or % this parameter represents the number of significant digits. When the measurement suffix is dB or dBm, 1 through 4 represents 1, 0.1, 0.01, and 0.001 dB respectively.

For further information refer to the resolution command on page 5-14.

Averaging

The power meter has a digital filter to average power readings. The number of readings averaged can range from 1 to 1024 in binary progression. This filter is used to reduce noise, obtain the desired resolution and to reduce the jitter in the measurement results. However, the time to take the measurement is increased. You can select the filter length or you can set the power meter to auto filter mode. To enable and disable averaging use the following command:

```
[SENSe[1]] | SENSe2:AVERage[:STATe] <Boolean>
```

Note

If you are using the HP 437B remote programming language you cannot enter a value of 1024.

Auto Averaging Mode

To enable and disable auto filter mode, use the following command:

```
[SENSe[1]] | SENSe2:AVERage:COUNT:AUTO <Boolean>
```

When the auto filter mode is enabled, the power meter automatically sets the number of readings averaged together to satisfy the filtering requirements for most power measurements. The number of readings averaged together depends on the resolution and the power level currently being measured. Figure 1-2 lists the number of readings averaged for each range and resolution when the power meter is in auto filter mode.

Figure 1-2: Averaged Readings

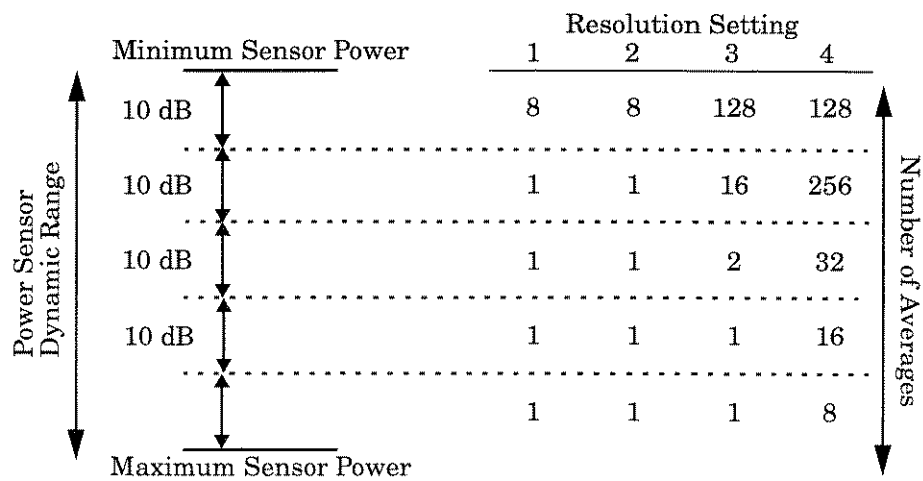
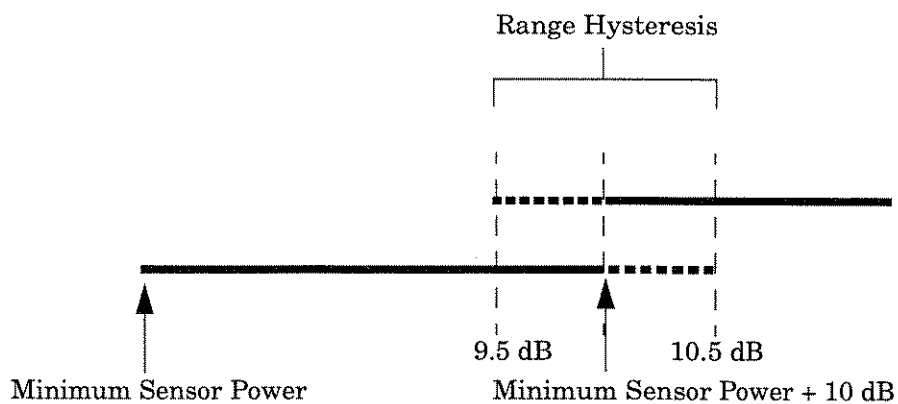

Figure 1-3 illustrates part of the power sensor dynamic range hysteresis.

Figure 1-3: Averaging Range Hysteresis



Power Meter Remote Operation
Setting the Range, Resolution and Averaging

Filter Length

You specify the filter length using the following command:

```
[SENSe[1]]|SENSe2:AVERAge:COUNT <numeric_value>
```

The range of values for the filter length is 1 to 1024. Specifying this command disables automatic filter length selection. If a numeric parameter is specified which is not a binary multiple, the power meter rounds to the nearest power of two. For example, if you specify a filter length of 5, the power meter rounds the value to 4. Increasing the value of the filter length reduces measurement noise. However, the time to take the measurement is increased.

Setting Offsets

Channel Offsets

The power meter can be configured to compensate for signal loss or gain in your test setup (for example, to compensate for the loss of a 10 dB attenuator). You use the SENSE command subsystem to configure the power meter. Gain and loss correction are a coupled system. This means that a gain set by [SENSE[1]]|SENSE2:CORREction:GAIN2 is represented in the [SENSE[1]]|SENSE2:CORREction:LOSS2? command. If you enter an offset value the state is automatically enabled. However it can be enabled and disabled using either the [SENSE[1]]|SENSE2:CORREction:GAIN2:STATE or [SENSE[1]]|SENSE2:CORREction:LOSS2:STATE commands.

LOSS2 is coupled to GAIN2 by the equation $Loss = \frac{1}{Gain}$ when the default unit is linear, and $Gain = -Loss$ when the default is logarithmic.

Note

You can only use LOSS2 and GAIN2 for external losses and gains. LOSS1 and GAIN1 are specifically for calibration factors.

Display Offsets

Display offset values can be entered using the CALCulate[1|2]:GAIN[:MAGNitude] command. CALCulate[1|2]:GAIN:STATE must be set to ON to enable the offset value. If you enter an offset value the state is automatically enabled. On the HP EPM-442A this offset is applied after any math calculations (refer to Figure 1-8 on page 1-58).

Power Meter Remote Operation
Setting Offsets

Example

The following example program, in HP Basic, details how to use the channel and display offsets on an HP EPM-442A making a channel A/B ratio measurement. The final result will be:

$$\left(\left(\frac{A_{\text{dBm}} - 10}{B_{\text{dBm}} - 10} \right) - 20 \right)_{\text{dB}}$$

```
10 !Create I/O path name
20 ASSIGN @POWER TO 713
30 !Clear the power meter's interface
40 CLEAR @POWER
50 !Set the power meter to a known state
60 OUTPUT @POWER; "*RST"
70 !Configure the Power Meter to make the measurement
80 OUTPUT @Power; "CONF:POW:AC:RAT 20DBM,2,(@1),(@2)"
90 !Set the measurement units to dBm
100 OUTPUT @POWER; "UNIT:POW DBM"
110 !Set the power meter for channel offsets of -10 dB
120 OUTPUT @POWER; "SENS1:CORR:GAIN2 -10"
130 OUTPUT @POWER; "SENS2:CORR:GAIN2 -10"
140 !Enable the gain correction
150 OUTPUT @POWER; "SENS:CORR:GAIN2:STATE ON"
160 OUTPUT @POWER; "SENS2:CORR:GAIN2:STATE ON"
170 !Set the power meter for a display offset of -20 dB
180 OUTPUT @POWER; "CALC1:GAIN -20 DB"
190 PRINT "MAKING THE MEASUREMENT"
200 !Initiate the measurement
210 OUTPUT @Power; "INIT1:IMM"
220 OUTPUT @Power; "INIT2:IMM"
230 ! ... and get the result
240 OUTPUT @Power; "FETC:POW:AC:RAT? 20DBM,2,(@1),(@2)"
250 ENTER @Power; Reading
260 !
270 PRINT "The measurement result is "; Reading; "dB."
280 END
```

For further information on channel offsets refer to page 9-23 through page 9-32.

For further information on display offsets refer to page 3-3.

Setting Measurement Limits

The power meter can be configured to verify the power being measured against an upper and/or lower limit value. The range of values that can be set for lower and upper limits is -150.00 dBm to +230.00 dBm. The default upper limit is +90.00 dBm and the default lower limit is -90.00 dBm.

A typical application for this feature is shown in Figure 1-4.

Figure 1-4: Limits Checking Application

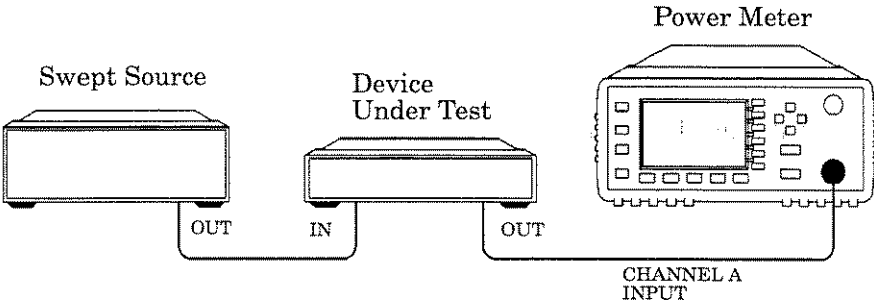
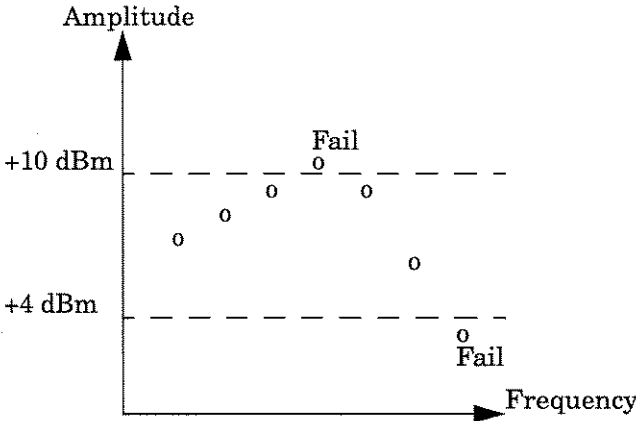

Figure 1-5: Limits Checking Results



Power Meter Remote Operation Setting Measurement Limits

In this application a swept frequency signal is applied to the input of the Device Under Test. The power meter measures the output power. The limits have been set at +4 dBm and +10 dBm. A fail occurs each time the output power is outside these limits. Use the `SENSE` subsystem to configure the power meter for limits checking. The following example program, in HP Basic, shows how to set the limits to +4 dBm and +10 dBm.

```
10 !Create I/O path name
20 ASSIGN @Power to 713
30 !Clear the Power Meter's Interface
40 CLEAR @Power
50 !Set the Power Meter to a known state
60 OUTPUT @Power;"*RST"
70 !Set the measurement units to dBm
80 OUTPUT @Power;"UNIT:POWER DBM"
90 !Set the upper limit to 10 dBm
100 OUTPUT @Power;"SENSE:LIMit:UPPer 10"
110 !Set the lower limit to 4 dBm
120 OUTPUT @Power;"SENSE:LIMit:LOWer 4"
130 !Switch the limit checking on
140 OUTPUT @Power;"SENSE:LIMit:STATe ON"
150 !Check the limits
160 OUTPUT @Power;"SENSE:LIMit:UPPer?"
170 ENTER @Power;A
180 OUTPUT @Power;"SENSE:LIMit:LOWer?"
190 ENTER @Power;B
200 PRINT A,B
210 END
```

Checking for Limit Failures

There are two ways to check for limit failures; using the `SENSE:LIMit:FAIL?` and the `SENSE:LIMit:FCOunt?` commands or using the `STATus` command subsystem.

Using SENSE

Using SENSE to check the limit failures in Figure 1-5 would return the following results:

SENSE:LIMit:FAIL?

Returns 1 if there has been 1 or more limit failures or 0 if there have been no limit failures. In this case 1 is returned.

SENSE:LIMit:FCOunt?

Returns the total number of limit failures, in this case 2.

Note

If TRIGger:DElay:AUTO is set to ON, then the number of failures returned by SENSE:LIMit:FCOunt? will be affected by the current filter settings.

Refer to page 9-40 and page 9-41 for further information on using these commands.

Using STATUS

You can use the STATUS subsystem to generate an SRQ to interrupt your program when a limit failure occurs. This is a more efficient method than using SENSE, since you do not need to check the limit failures after every power measurement.

Refer to "Status Reporting", on page 1-59 and "STATUS Subsystem", on page 10-1 for further information.

Measuring Pulsed Signals

The power meter can be used to measure the power of a pulsed signal. The measurement result is a mathematical representation of the pulse power rather than an actual measurement. The power meter measures the average power of the pulsed input signal and then divides the measurement result by the duty cycle value to obtain the pulse power reading. The allowable range of values is 0.001% to 99.999%. The default is 1.000%. A duty cycle value can be set using the following command:

```
[SENSe[1]] | SENSe2:CORRection:DCYClE|GAIN3 <numeric_value>
```

Note

Pulse measurements are not recommended using HP ECP series power sensors.

Making the Measurement

An example of a pulsed signal is shown in Figure 1-6.

Figure 1-6: Pulsed Signal

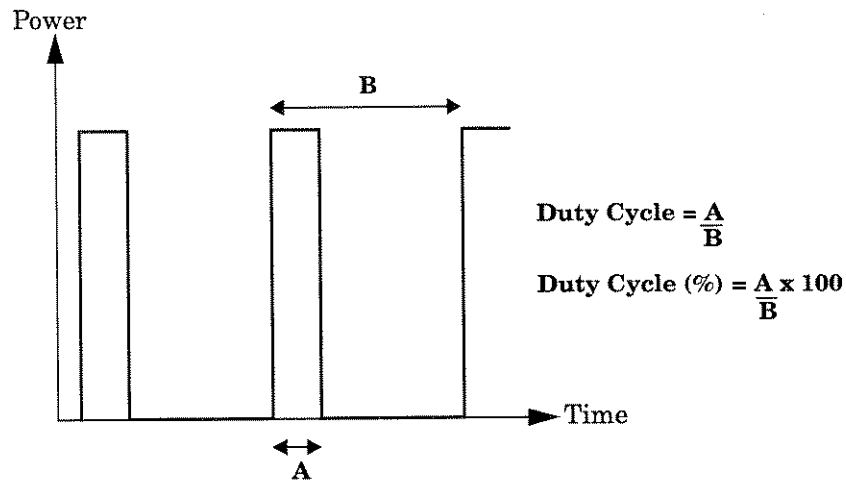

You use the `SENSe` command subsystem to configure the power meter to measure a pulsed signal. The following example program, in HP Basic, shows how to measure the signal for the HP 8480 series power sensors.

Power Meter Remote Operation
Measuring Pulsed Signals

```
10 !Create I/O path name
20 ASSIGN @Power TO 713
30 !Clear the Power Meter's Interface
40 CLEAR @Power
50 !Set the Power Meter to a known state
60 OUTPUT @Power;"*RST"
70 !Configure the Power Meter to make the measurement
80 OUTPUT @Power;"CONF:POW:AC 20DBM,2,(@1)"
90 !Set the reference calibration factor for the sensor
100 OUTPUT @Power;"CAL:RCF 98.7PCT"
110 !Zero and calibrate the power meter
120 OUTPUT @Power;"CAL?"
130 PRINT "ZEROING AND CALIBRATING THE POWER METER"
140 !Verify the outcome
150 ENTER @Power;Success
160 IF Success=0 THEN
170     !Calibration cycle was successful
180     !
190     !Set the measurement units to Watts
200     OUTPUT @Power;"UNIT:POW WATT"
210     !
220     !Set the measurement calibration factor for the
        sensor
230     OUTPUT @Power;"SENS:CORR:CFAC 97.5PCT"
240     !Set the power meter for a duty cycle of 16PCT
250     OUTPUT @Power;"SENS1:CORR:DCYC 16PCT"
260     !
270     !Enable the duty cycle correction
280     OUTPUT @Power;"SENS:CORR:DCYC:STAT ON"
290     PRINT "MAKING THE MEASUREMENT"
300     !Initiate the measurement
310     OUTPUT @Power;"INIT1:IMM"
320     !... and get the result
330     OUTPUT @Power;"FETC?"
340     ENTER @Power;Reading
350     !
360     PRINT "The result is          ";Reading*1000;"mW"
370     !
380 ELSE
390     PRINT "THERE WAS A CALIBRATION ERROR!"
400 END IF
410 PRINT "PROGRAM COMPLETED"
420 END
```

Power Meter Remote Operation
Measuring Pulsed Signals

Note

Pulse power averages out any aberrations in the pulse such as overshooting or ringing. For this reason it is called pulse power and not peak power or peak pulse power.

In order to ensure accurate pulse power readings, the input signal must be pulsed with a rectangular pulse. Other pulse shapes (such as triangle, chirp or Gaussian) will cause erroneous results.

The pulse power on/off ratio must be much greater than the duty cycle ratio.

Triggering the Power Meter

Triggering is a feature that is only available via remote programming of the power meter.

The power meter has two modes of operation, standby mode and free run mode. During local operation the power meter is always in free run mode. During remote operation the power meter can operate in either free run mode or standby mode and can be switched between modes at any time.

- a) Standby mode means the power meter is making measurements, but the display and HP-IB are not updated until a trigger command is received.

In this mode the power meter is either waiting to be initiated, or waiting for a trigger (See "Trigger System" on page 51.).

- b) Free run mode is the preset mode of operation and is identical to local operation. The measurement result data available to the HP-IB is continuously updated as rapidly as the power meter makes measurements. Entry into local mode via Preset Local sets the power meter to free run mode

In this mode INITiate:CONTinuous is set to ON and TRIGger:SOURce is set to IMMEDIATE.

To obtain accurate measurements, ensure that the input power to the power sensor is settled before making a measurement.

The trigger configuration is automatically set by the MEASURE? command. If you want to use the lower level commands (READ? or INITiate), you need to understand the power meter's trigger model.

Power Meter Remote Operation
Triggering the Power Meter

Triggering the power meter from the remote interface is a process that offers triggering flexibility. The process is:

1. Specify the source from which the power meter will accept the trigger. The trigger source specifies which event causes the trigger system to travel through the event detection state. See “Event Detection State”, on page 1-52 for details.
2. Make sure that the power meter is ready to accept a trigger. This is called the “wait-for-trigger” state. Sending a device clear, a *RST or an ABORT forces the trigger system into the idle state. The trigger system remains in the idle state until it is moved into the “wait-for-trigger” state by executing an INITiate command.

The “wait-for-trigger” state is a term used only for remote interface operation.

The TRIGger commands are used to synchronize power meter actions with specified events. Figure 1-7 summarizes the power meter’s trigger system.

Figure 1-7: Trigger System

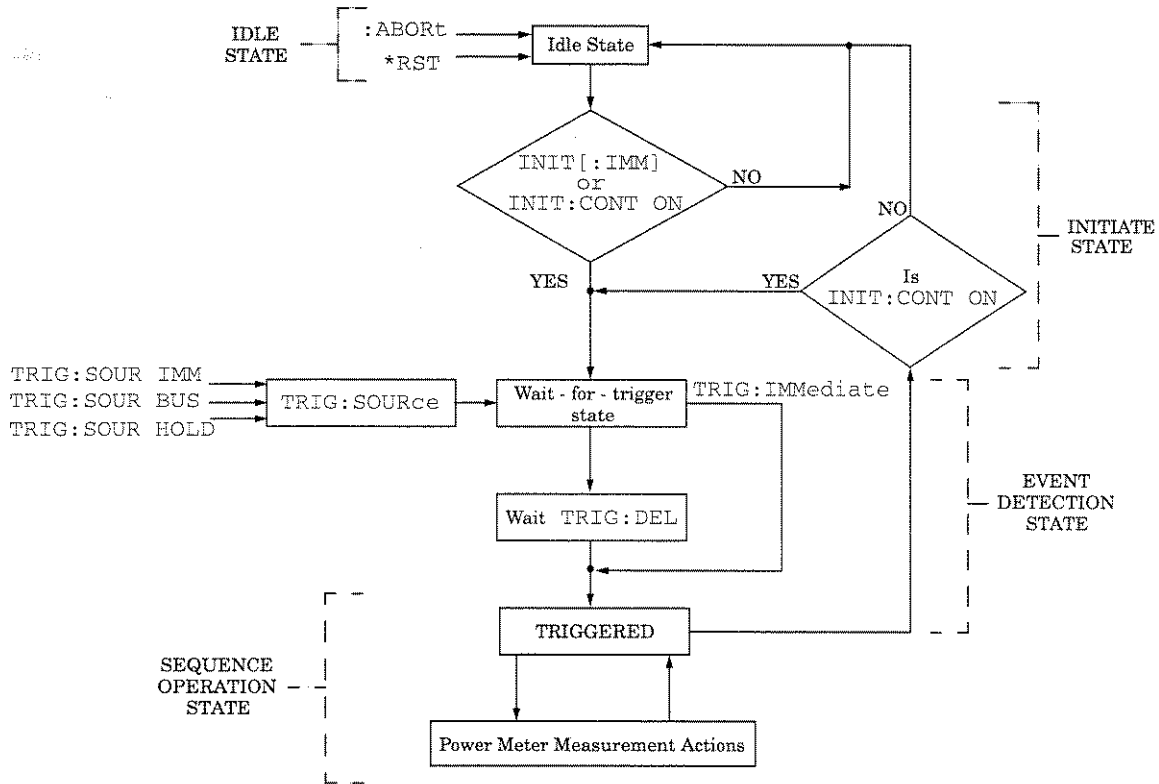

Idle State

Turning power on, sending an HP-IB CLEAR, sending a *RST or an :ABORT forces the trigger system into the idle state. The trigger system remains in the IDLE state until it is initiated by INITiate:CONTinuous ON or INITiate:IMMediate. Once one of these conditions is satisfied the trigger system moves to the initiate state.

Initiate State

If the trigger system is on the downward path, it travels directly through the initiate state without any restrictions. If the trigger system is on the upward path, and INITiate:CONTInuous is ON, it exits downwards to the event detection state. If the trigger system is on the upward path and INITiate:CONTInuous is OFF, it exits upwards to the idle state.

Event Detection State

The trigger source specifies which event causes the trigger system to travel through the event detection state. The trigger source is set with the following command:

```
TRIGger:SOURCE
```

There are three possible trigger sources.

- **BUS**
The trigger source is the HP-IB group execute trigger (<GET>), a *TRG command, or the TRIGger:IMMediate command.
- **HOLD**
Triggering is suspended. The only way to trigger the power meter is to send TRIGger:IMMediate.
- **IMMediate**
The power meter does not wait for any event and immediately travels through the event detection state.

Querying the Trigger Source

The trigger source is queried with the following command:

```
TRIGger:SOURCE
```

Trigger Delay

The power meter has the ability to insert a delay between receiving a trigger and making the measurement. The delay is automatically calculated by the power meter and depends on the current filter length. The delay ensures that the analog circuitry and the digital filters in the power meter have settled. It does not allow time for power sensor delay.

To enable the delay, use the following command:

```
TRIGger:DELay:AUTO ON
```

To disable the delay, use the following command:

```
TRIGger:DELay:AUTO OFF
```

Note

MEASure? and CONFIgure automatically enable the delay. Also, when the power meter is first powered on the delay is enabled. For the fastest possible measurements the delay should be disabled.

Getting the Best Speed Performance

This section discusses the factors that influence the speed of operation (number of readings/sec) of an HP EPM-441/2A power meter.

The following factors are those which have the greatest effect upon measurement speed (in no particular order):

- The selected speed i.e. 20, 40 or 200 readings/sec.
- The trigger mode (for example, free run, trigger with delay etc.).
- The output format i.e. ASCII or REAL.
- The units used for the measurement.
- The command used to take a measurement.

In addition, in 200 reading/sec mode there are other influences which are described in "200 Readings/Sec", on page 1-56.

The following paragraphs give a brief description of the above factors and how they are controlled from SCPI.

Speed

There are three possible speed settings 20, 40 and 200 readings/sec. These are set using the `SENSe:SPEEd` command and can be applied to each channel independently (HP EPM-442A only). The speed setting controls the cycle time of the measurement i.e., 50ms, 25ms and 5ms respectively.

In 20 and 40 readings/sec mode, full instrument functionality is available; 200 readings/sec is available only for E-series sensors and averaging, offsets, limits, and ratio/difference math functions are disabled.

Refer to "Specifications" in chapter 5 of the User's Guide to see the influence of these speed settings on the accuracy and noise performance of the power meter.

Trigger Mode

The power meter has a very flexible triggering system. For simplicity, it can be described as having three modes:

Free run

A channel is in free run when `INITiate:CONTinuous` is set to ON and `TRIGger:SOURce` is set to IMMEDIATE.

Trigger immediate

There are a variety of methods to achieve this:

```
TRIG:DEL:AUTO OFF
INIT:CONT OFF
TRIG:SOUR IMM
INIT
```

```
TRIG:SOUR BUS
INIT:CONT ON
TRIG
```

```
TRIG:DEL:AUTO OFF
TRIG:SOUR BUS
INIT:CONT ON
GET or *TRG
```

```
TRIG:DEL:AUTO OFF
INIT:CONT OFF
TRIG:SOUR IMM
READ?
```

Trigger with delay

This can be achieved using the same sequences above (apart from the second) with `TRIG:DEL:AUTO` set to ON. Also, the `MEAS?` command operates in trigger with delay mode.

In trigger with delay mode, a measurement is not completed until the power meter filter is full. In this way, the reading returned is guaranteed to be settled. In all other modes, the result returned is simply the current result from the filter and may or may not be settled. This depends on the current length of the filter and the number of readings that have been taken since a change in power level.

With trigger with delay enabled, the measurement speed can be calculated roughly using the following equation:

$$\text{readings/sec} = \text{speed (as set by SENSE:SPED)} / \text{filter length}$$

Power Meter Remote Operation Getting the Best Speed Performance

For example, with a filter length of 4 and `SENS:SPE` set to 20, approximately 5 readings/sec will be calculated by the power meter.

In general, free run mode will provide the best speed performance from the power meter (especially in 200 readings/sec mode).

Output Format

The power meter has two output formats for measurement results: `ASCIi` and `REAL`. These formats can be selected using the `FORMat` command. When `FORMat` is set to `REAL`, the result returned is in IEEE 754 floating-point format (note that the byte order can be changed using `FORMat:BORDER`).

The `REAL` format is likely to be required only for 200 readings/sec mode as a means to reduce bus traffic.

Units

The power meter can output results in either linear or log units. The internal units are linear and therefore optimal performance will be achieved when the results output are also in linear units (since the overhead of performing a log function is removed).

Command Used

In free run trigger mode, `FETC?` must be used to retrieve a result.

In other trigger modes, there are a number of commands which can be used, for example, `MEAS?`, `READ?`, `FETC?` Note that the `MEAS?` and `READ?` commands are compound commands i.e., they perform a combination of other lower level commands. In general, the best speed performance will be achieved using the low level commands directly.

200 Readings/Sec

In the highest speed setting, the limiting factor tends to be the speed of the controller being used to retrieve results from the power meter and to a certain extent the volume of HP-IB traffic. The latter can be reduced using the `FORMat REAL` command to return results in binary format. The former is a combination of two factors:

- the hardware platform being used.
- the programming environment being used.

Note that it is unlikely that 200 readings/sec can be achieved when:

- you are using a 700 series HP/UX workstation.
- you are using a low end PC.
- you are using a graphical programming environment (such as HP VEE).

Dual Channel Considerations

With the dual channel instrument, consideration must be taken of what operation is required on both channels. Both channels can achieve 20 readings/sec simultaneously, and 40 readings/sec simultaneously, but 200 readings/sec is not achievable on both channels at the same time. If only single channel measurements are required, then the other channel should be set to standby mode and not triggered.

The throughput for a channel set in the 200 readings/sec mode will be affected by the speed mode of the other channel. However, in a situation where fast measurements are required on one channel and slow measurements on the other, it will be possible to perform more than one measurement cycle on the fast channel for every measurement on the slow channel. For example, if channel A is set to 40 readings /sec and channel B is set to 20 readings/sec, it is possible to construct a loop with 2 reads from channel A and one from channel B and still achieve the set readings per second.

How Measurements are Calculated

Figure 1-8 details how measurements are calculated. It shows the order in which the various power meter functions are implemented in the measurement calculation.

Figure 1-8: How Measurements are Calculated

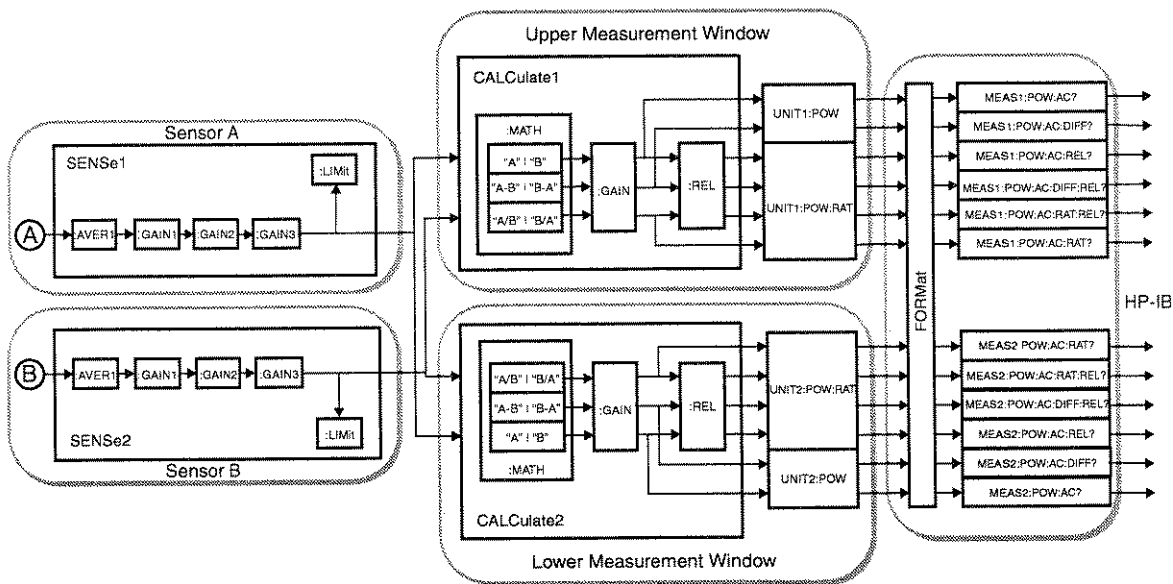

The MEASure commands in this figure can be replaced with the FETCH? and READ? commands.

Note

All references to channel B in the above diagram refer to the HP EPM-442A only. The MEAS[1 | 2]:POW:AC? and MEAS[1 | 2]:POW:AC:REL? are the only commands relevant to the HP EPM-441A.

Each of the 16-bit status groups consists of 5 registers as shown on page 1-60.

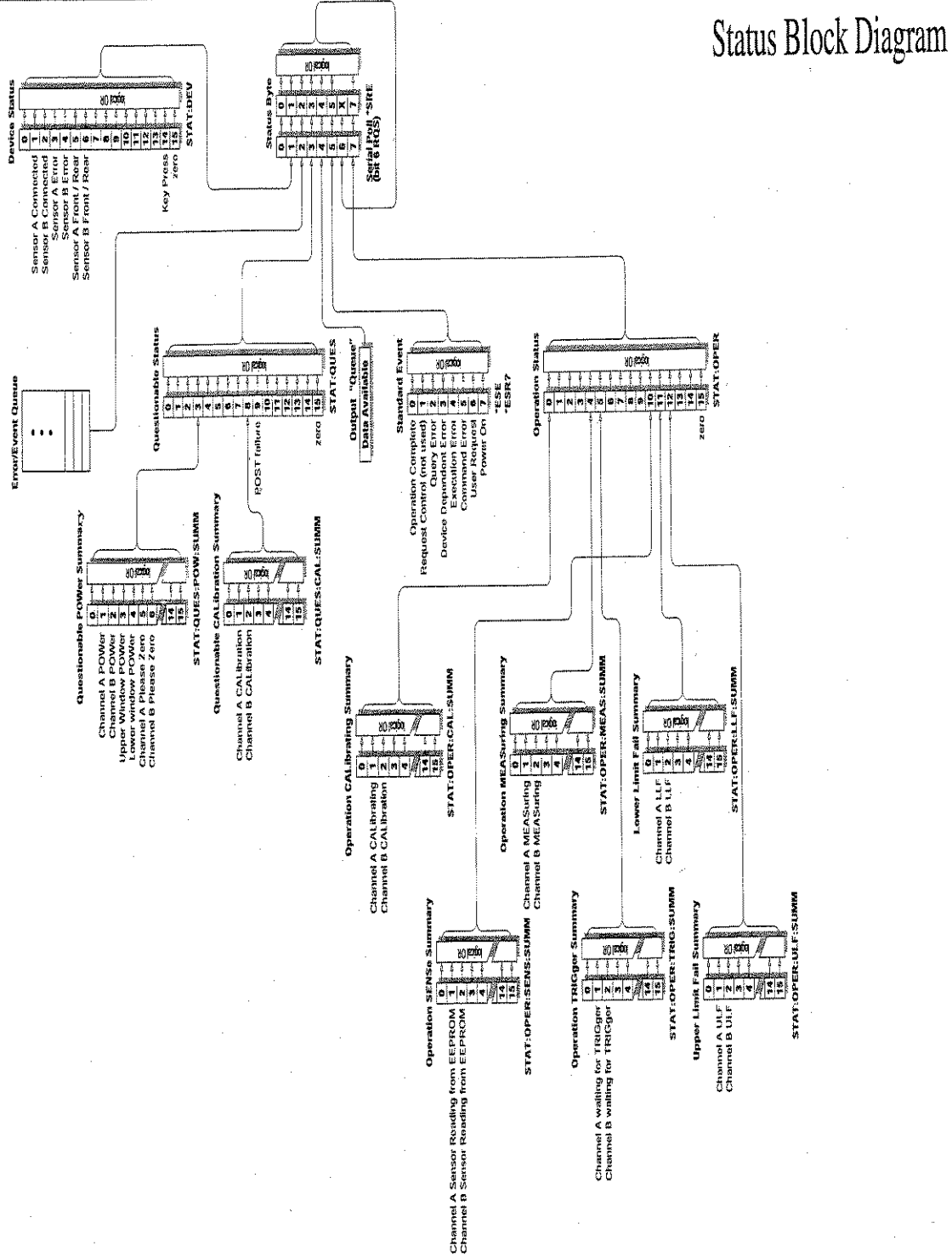

Status Reporting

Status reporting is used to monitor the power meter to determine when events have occurred. Status reporting is accomplished by configuring and reading status registers. The power meter has the following main registers:

- Status Register
- Standard Event Register
- Operation Status Register
- Questionable Status Register
- Device Status Register

There are a number of other registers “behind” these. These are described later.

The Status and Standard Event registers are read using the IEEE-488.2 common commands. These are the most commonly used registers and are described in detail in this section.

The Operation and Questionable Status registers are read using the SCPI `STATUS` command subsystem.

The General Status Register Model

The generalized status register model shown in Figure 1-9 is the building block of the SCPI status system. This model consists of a condition register, a transition filter, an event register and an enable register. A set of these registers is called a status group.

Figure 1-9: Generalized Status Register Model

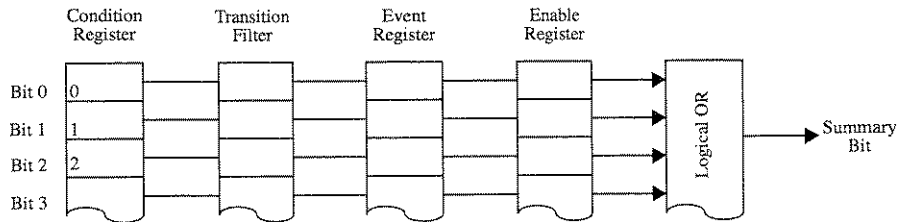

When a status group is implemented in an instrument, it always contains all of the component registers. However, there is not always a corresponding command to read or write to every register.

Condition Register

The condition register continuously monitors the hardware and firmware status of the power meter. There is no latching or buffering for this register, it is updated in real time. Condition registers are read-only.

Transition Filter

The transition filter specifies which types of bit state changes in the condition registers will set corresponding bits in the event register. Transition filter bits may be set for positive transitions (PTR), negative transitions (NTR), or both. Transition filters are read-write. They are unaffected by *CLS or queries. After STATUS:PRESet the NTR register is set to 0 and all bits of the PTR are set to 1.

Event Register

The event register latches transition events from the condition register as specified by the transition filter. Bits in the event register are latched and once set they remain set until cleared by a query or a *CLS. Once set, an event bit is no longer affected by condition changes. It remains set until the event register is cleared; either when you read the register or when you send the *CLS (clear status) command. Event registers are read-only.

Enable Register

The enable register specifies the bits in the event register that can generate a summary bit. The instrument logically ANDs corresponding bits in the event and enable registers and ORs all the resulting bits to obtain a summary bit. Enable registers are read-write. Querying an enable register does not affect it.

An Example Sequence

Figure 1-10 illustrates the response of a single bit position in a typical status group for various settings. The changing state of the condition in question is shown at the bottom of the figure. A small binary table shows the state of the chosen bit in each status register at the selected times T1 to T5.

Figure 1-10: Typical Status Register Bit Changes

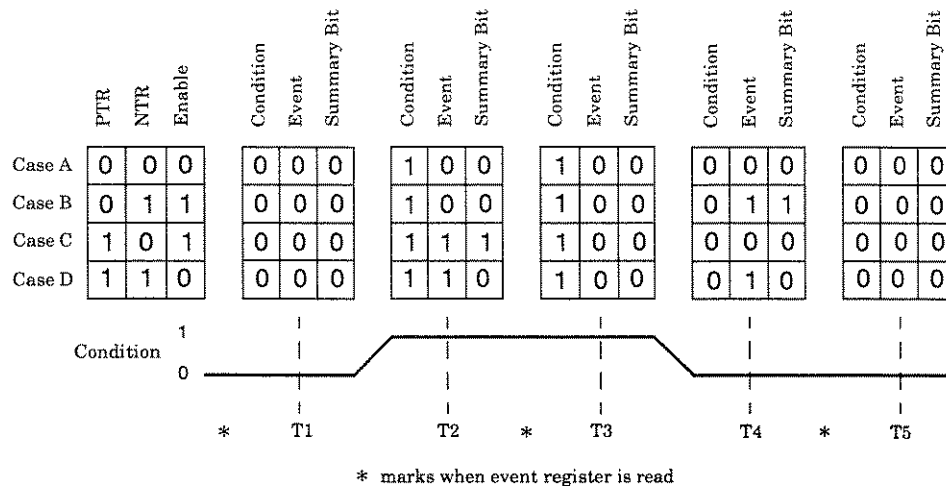

How to Use Registers

There are two methods you can use to access the information in status groups:

- the polling method, or
- the service request (SRQ) method.

Use the polling method when:

- your language/development environment does not support SRQ interrupts.
- you want to write a simple, single purpose program and do not want to add the complexity of setting an SRQ handler.

Use the SRQ method when you:

- need time critical notification of changes.
- are monitoring more than one device which supports SRQ interrupts.
- need to have the controller do something else while it's waiting.
- cannot afford the performance penalty inherent to polling.

The Condition Polling Method

In this polling method, the power meter has a passive role. It only informs the controller that conditions have changed when the controller asks.

When you monitor a condition with the polling method, you must:

1. Determine which register contains the bit that monitors the condition.
2. Send the unique HP-IB query that reads that register.
3. Examine the bit to see if the condition has changed.

The polling method works well if you do not need to know about the changes the moment they occur. The SRQ method is more effective if you must know immediately when a condition changes. Detecting an immediate change in a condition using the polling method requires your program to continuously read the registers at very short intervals. This is not particularly efficient and there is a possibility that an event may be missed.

Power Meter Remote Operation
Status Reporting

The SRQ Method

When a bit of the Status Register is set and has been enabled to assert SRQ (*SRE command), the power meter sets the HP-IB SRQ line true. This interrupt can be used to interrupt your program to suspend its current operation and find out what service the power meter requires. (Refer to your computer and language manuals for information on how to program the computer to respond to the interrupt).

To allow any of the Status Register bits to set the SRQ line true, you have to enable the appropriate bit(s) with the *SRE command. For example, suppose your application requires an interrupt whenever a message is available in the output queue (Status Register bit 4, decimal weight 16). To enable bit 4 to assert SRQ, you use the following command:

```
*SRE 16
```

Note

You can determine which bits are enabled in the Status Register using *SRE?. This command returns the decimal weighted sum of all the bits.

Procedure

- Send a bus device clear message.
- Clear the event registers with the *CLS (clear status) command.
- Set the *ESE (standard event register) and *SRE (status byte register) enable masks.
- Enable your bus controller's IEEE-488 SRQ interrupt.

Examples

The following two examples are written in HP BASIC and illustrate possible uses for SRQ. In both cases, it is assumed that the meter has been zeroed and calibrated.

Example 1:

```
10 ! Program to generate an SRQ when a channel A sensor
20 ! connect or disconnect occurs
30 !
40 ASSIGN @Pm TO 713 ! Power meter HP-IB address
50 ON ON INTR 7 GOTO Srq_i! Define service request handler
60 CLEAR @Pm ! Selective device clear
70 OUTPUT @Pm;"*CLS;*RST" ! Clear registers and reset meter
80 !
```



```
90  ! Configure the device status register so that a sensor
100 ! connect or disconnect on channel A will cause an SRQ.
110 !
120 OUTPUT @Pm;"STAT:DEV:ENAB 2"
130 OUTPUT @Pm;"STAT:DEV:NTR 2"
140 OUTPUT @Pm;"STAT:DEV:PTR 2"
150 OUTPUT @Pm;"*SRE 2"
160 !
170 ENABLE INTR 7;2 ! Enable an SRQ to cause an interrupt
180 LOOP           ! Idle loop
190 ! Forever
200 END LOOP
210 !
220 ! When a SRQ is detected , the following routine will
      service it.
230 !
240 Srq_i:      !
250 St=SPOLL(@Pm)      ! Serial Poll (reads status byte)
260 IF BIT(St,1)=1 THEN ! Device status reg bit set ?
270   OUTPUT @Pm;"STAT:DEV:EVEN?" ! Yes , read register
280   ENTER @Pm;Event           ! (this also clears it)
290   OUTPUT @Pm;"STAT:DEV:COND?"
300   ENTER @Pm;Cond
310   IF Cond=0 THEN
320     PRINT "Sensor disconnected"
330   ELSE
340     PRINT "Sensor connected"
350   END IF
360 END IF
370 GOTO 170           ! Return to idle loop
380 END
```

Example 2:

```
10  ! Program to generate an SRQ when an over limit
20  ! condition occurs.
30  !
40  ASSIGN @Pm TO 713      ! Power meter HP-IB address
50  ON INTR 7 GOTO Srq_i   ! Define service request handler
60  CLEAR @Pm             ! Selective device clear
70  OUTPUT @Pm;"*CLS"     ! Clear registers
80  OUTPUT @Pm;"SYST:PRES" ! Preset meter
90  !
```

**Power Meter Remote Operation
Status Reporting**

```
100  ! Set upper limit to 2dBm and configure the operation
      status
110  ! so that an over limit condition will cause an SRQ.
120  !
130  OUTPUT @Pm;"SENS:LIM:UPP 2DBM"
140  OUTPUT @Pm;"SENS:LIM:STAT ON"
150  OUTPUT @Pm;"STAT:OPER:PTR 4096"
160  OUTPUT @Pm;"STAT:OPER:ENAB 4096"
170  OUTPUT @Pm;"*SRE 128"
180  !
190  ENABLE INTR 7;2  ! Enable an SRQ to cause an interrupt
200  LOOP              ! Idle loop
210  ! Forever
220  END LOOP
230  !
240  ! When a SRQ is detected , the following routine will
      service it.
250  !
260  Srq_i:           !
270  St=SPOLL(@Pm)      ! Serial Poll (reads status byte)
280  IF BIT(St,7)=1 THEN ! Operation status bit set?
290  OUTPUT @Pm;"STAT:OPER?"! Yes , read register
300  ENTER @Pm;Oper    ! (this also clears it)
310  OUTPUT @Pm;"STAT:OPER:ULF?"
320  ENTER @Pm;Ulf
330  IF Ulf=2 THEN PRINT "Over limit detected"
340  END IF
350  GOTO 190          ! Return to idle loop
360  END
```

**Power Meter Remote Operation
Status Reporting**

Status Register

The Status System in the power meter is shown in Figure 1-11. The Operation Status and Questionable Status groups are 16 bits wide, while the Status Byte and Standard Event groups are 8 bits wide. In all 16-bit groups, the most significant bit (bit 15) is not used and is always set to 0.

Figure 1-11: Status System

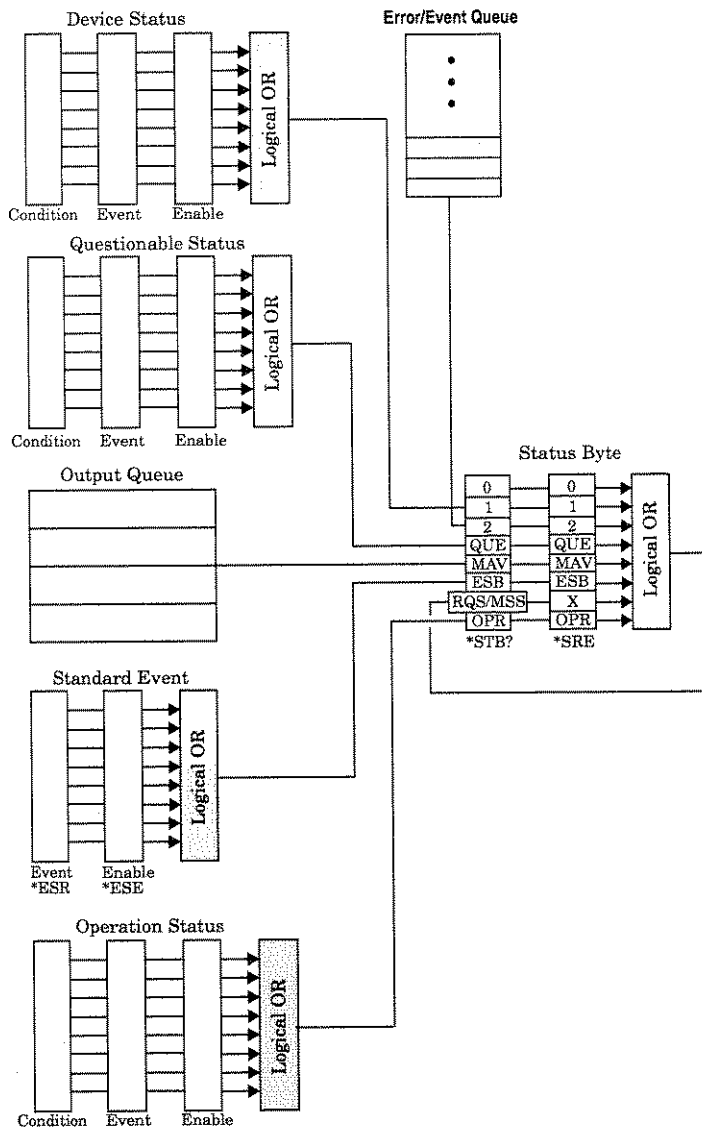

The Status Byte

The status byte summary register reports conditions from other status registers. Query data waiting in the power meter's output buffer is immediately reported through the "message available" bit (bit 4). Clearing an event register clears the corresponding bits in the status byte summary register. Reading all messages in the output buffer, including any pending queries, clears the message available bit.

Table 1-3: Bit Definitions - Status Byte Register

Bit Number	Decimal Weight	Definition
0	1	Not Used (Always set to 0)
1	2	Device Status Register summary bit. One or more bits are set in the Device Status Register (bits must be "enabled" in enable register)
2	4	Error/Event Queue
3	8	Questionable Status Register summary bit. One or more bits are set in the Questionable Status Register (bits must be "enabled" in enable register).
4	16	Message Available Data is available in the power meter's output buffer.
5	32	Standard Event One or more bits are set in the Standard Event register (bits must be "enabled" in enable register).
6	64	Request Service The power meter is requesting service (serial poll).
7	128	Operation Status Register summary bit. One or more bits are set in the Operation Status Register (bits must be "enabled" in enable register).

Power Meter Remote Operation Status Reporting

Particular bits in the status byte register are cleared when:

- The standard event, Questionable status, operation status and device status are queried.
- The error/event queue becomes empty.
- The output queue becomes empty.

The status byte enable register (SRE, service request enable) is cleared when you:

- cycle the instrument power.
- execute a *SRE 0 command.

Using *STB? to Read the Status Byte

The *STB? (status byte query) command is similar to a serial poll except it is processed like any other power meter command. The *STB? command returns the same result as an IEEE-488 serial poll except that the request service bit (bit 6) is *not* cleared if a serial poll has occurred. The *STB? command is not handled automatically by the IEEE-488 bus interface hardware and the command will be executed only after previous commands have completed. Using the *STB? command does not clear the status byte summary register.

The Standard Event Register

The standard event register reports the following types of instrument events: power-on detected, command and syntax errors, command execution errors, self-test or calibration errors, query errors, or when an overlapped command completes following a *OPC command. Any or all of these conditions can be reported in the standard event summary bit through the enable register. You must write a decimal value using the *ESE (event status enable) command to set the enable register mask.

Table 1-4: Bit Definitions - Standard Event Register

Bit Number	Decimal Value	Definition
0	1	Operation Complete All overlapped commands following an *OPC command have been completed.
1	2	Not Used. (Always set to 0.)
2	4	Query Error A query error occurred, refer to error numbers 410 to 440 in the <i>User's Guide</i> .
3	8	Device Error A device error occurred, refer to error numbers 310 to 350 in the <i>User's Guide</i> .
4	16	Execution Error An execution error occurred, refer to error numbers 211 to 241 in the <i>User's Guide</i> .
5	32	Command Error A command syntax error occurred, refer to error numbers 101 to 161 in the <i>User's Guide</i> .
6	64	Not Used. (Always set to 0.)
7	128	Power On Power has been turned off and on since the last time the event register was read or cleared.

The standard event register is cleared when you:

- send a *CLS (clear status) command.
- query the event register using the *ESR? (event status register) command.

The standard event enable register is cleared when you:

- cycle the instrument power.
- execute a *ESE 0 command.

Power Meter Remote Operation
Status Reporting

Questionable Status Register

The questionable status register provides information about the quality of the power meter's measurement results. Any or all of these conditions can be reported in the questionable data summary bit through the enable register. You must write a value using the `STATUS:QUESTIONABLE:ENABLE` command to set the enable register mask.

The questionable status model is shown in the pullout at the end of this chapter.

The following bits in these registers are used by the power meter.

Bit Number	Decimal Weight	Definition
0 to 2	-	Not used
3	8	POWER Summary
4 to 7	-	Not used
8	256	CALibration Summary
9	512	Power On Self Test
10 to 14	-	Not Used
15	-	Not used (always 0)

The condition bits are set and cleared under the following conditions:

Bit Number	Meaning	EVENTs Causing Bit Changes
3	POWER Summary	<p>This is a summary bit for the Questionable POWER Register.</p> <p>SET:</p> <p>Error -230, "Data corrupt or stale" Error -231, "Data questionable;Input Overload" Error -231, "Data questionable;Input Overload ChA"¹ Error -231, "Data questionable;Input Overload ChB"¹ Error -231, "Data questionable;PLEASE ZERO" Error -231, "Data questionable;PLEASE ZERO ChA"¹ Error -231, "Data questionable;PLEASE ZERO ChB"¹ Error -231, "Data questionable;Lower window log error"¹ Error -231, "Data questionable;Upper window log error"¹</p> <p>CLEARED: When no errors are detected by the power meter during a measurement covering the causes given for it to set.</p>
8	CALibration Summary	<p>This is a summary bit for the Questionable CALibration Register.</p> <p>SET:</p> <p>These may be caused by CALibration[1 2]:ZERO:AUTO ONCE or CALibration[1 2]:AUTO ONCE or CALibration[1 2][:ALL] or CALibration[1 2][:ALL]?</p> <p>Error -231, "Data questionable; ZERO ERROR" Error -231, "Data questionable; ZERO ERROR ChA"¹ Error -231, "Data questionable; ZERO ERROR ChB"¹ Error -231, "Data questionable; CAL ERROR" Error -231, "Data questionable; CAL ERROR ChA"¹ Error -231, "Data questionable; CAL ERROR ChB"¹</p> <p>CLEARED: When any of the commands listed above succeed and no errors are placed on the error queue.</p>
9	Power On Self Test	<p>SET: This bit is set when the power on self test fails.</p> <p>CLEARED: When the power on self test passes.</p>

1. HP EPM-442A only

Power Meter Remote Operation
Status Reporting

Operation Status

The Operation Status group monitors conditions in the power meter's measurement process.

The Operation status model is shown in the pullout at the end of this chapter.

The following bits in these registers are used by the power meter:

Bit Number	Decimal Weight	Definition
0	1	CALibrating Summary
1 - 3	-	Not used
4	16	MEASuring Summary
5	32	Waiting for TRIGger Summary
6 - 9	-	Not used
10	1024	SENSE Summary
11	2048	Lower Limit Fail Summary
12	4096	Upper Limit Fail Summary
13 to 14	-	Not used
15	-	Not used (always 0)

The condition bits are set and cleared under the following conditions:

Bit Number	Meaning	EVENTs Causing Bit Changes
0	CALibrating	This is a summary bit for the Operation CALibrating Register. SET: At beginning of zeroing (CALibration:ZERO:AUTO ONCE) and at the beginning of calibration (CALibration:AUTO ONCE). Also for the compound command/query CALibration[:ALL]?, this bit is set at the beginning of the zero. CLEARED: At the end of zeroing or calibration.

Bit Number	Meaning	EVENTs Causing Bit Changes
4	MEASuring	<p>This is a summary bit for the Operation MEASuring Register.</p> <p>SET: When the power meter is taking a measurement.</p> <p>CLEARED: When the measurement is finished.</p>
5	Waiting for TRIGger	<p>This is a summary bit for the Operation TRIGger Register.</p> <p>SET: When the power meter enters the “wait for trigger” state. Refer to Figure 1-7.</p> <p>CLEARED: When the power meter enters the “idle” state. Refer to Figure 1-7.</p>
10	SENSE	<p>This is a summary bit for the Operation SENSE Register.</p> <p>SET: When the power meter is reading data from the HP E-series power sensor EEPROM.</p> <p>CLEARED: When the power meter is not reading data from the HP E-series power sensor EEPROM.</p>
11	Lower Limit Fail	<p>This is a summary bit for the Lower Limit Fail Register.</p> <p>SET: If a power measurement is made and the lower limit test fails.</p> <p>CLEARED: If a power measurement is made and the lower limit test is not enabled or the test is enabled and passes.</p>
12	Upper Limit Fail	<p>This is a summary bit for the Upper Limit Fail Register.</p> <p>SET: If a power measurement is made and the upper limit test fails.</p> <p>CLEARED: If a power measurement is made and the upper limit test is not enabled or the test is enabled and passes.</p>

Power Meter Remote Operation
Status Reporting

Device Status Register

The device status register set contains bits which give device dependent information.

The following bits in these registers are used by the power meter:

Bit Number	Decimal Weight	Definition
0	-	Not used
1	2	Channel A sensor connected
2	4	Channel B sensor connected ¹
3	8	Channel A sensor error
4	16	Channel B sensor error ¹
5	32	Channel A sensor Front/Rear
6	64	Channel B sensor Front/Rear ¹
14	16384	Front Panel key press

1. HP EPM-442A only

The condition bits are set and cleared under the following conditions:

Bit Number	Meaning	EVENTs Causing Bit Changes
1	Channel A sensor connected	SET: When a power sensor is connected to the Channel A input. CLEARED: When no power sensor is connected to the Channel A input.
2	Channel B sensor connected	SET: When a power sensor is connected to the Channel B input. CLEARED: When no power sensor is connected to the Channel B input.
3	Channel A error	SET: If the power sensor EEPROM on Channel A has failed or if there are power sensors connected to both the rear and front panel Channel A connectors. CLEARED: In every other condition.
4	Channel B error	SET: If the power sensor EEPROM on Channel B has failed or if there are power sensors connected to both the rear and front panel Channel B connectors. CLEARED: In every other condition.
5	Channel A Front/Rear	SET: If a power sensor is connected to the Channel A rear panel. CLEARED: If a power sensor is connected to the Channel A front panel.
6	Channel B Front/Rear	SET: If a power sensor is connected to the Channel B rear panel. CLEARED: If a power sensor is connected to the Channel B front panel.
14	Front Panel Key Press	This is an event, and DOES NOT set the condition register. The bit will be set in the event register which will be cleared when read. Note that the transition registers are of no use for this bit.

Using the Operation Complete Commands

The *OPC? and *OPC commands allow you to maintain synchronization between the computer and the power meter. The *OPC? query command places an ASCII character 1 into the power meter's output queue when all pending power meter commands are complete. If your program reads this response before continuing program execution, you can ensure synchronization between one or more instruments and the computer.

The *OPC command sets bit 0 (Operation Complete) in the Standard Event Status Register when all pending power meter operations are complete. By enabling this bit to be reflected in the Status Register, you can ensure synchronization using the HP-IB serial poll.

Procedure

- Send a device clear message to clear the power meter's output buffer.
- Clear the event registers with the *CLS (clear status) command.
- Enable operation complete using the *ESE 1 command (standard event register).
- Send the *OPC? (operation complete query) command and enter the result to assure synchronization.
- Send your programming command string, and place the *OPC (operation complete) command as the last command.
- Use a serial poll to check to see when bit 5 (standard event) is set in the status byte summary register. You could also configure the power meter for an SRQ interrupt by sending *SRE 32 (status byte enable register, bit 5).

Examples

This example program uses the *OPC? command to determine when the power meter has finished calibrating.

```
CAL:AUTO ONCE
*OPC?
MEAS:POW:AC?
```

This example program, in HP Basic, uses the *OPC command and serial poll to determine when the power meter has finished calibrating. The advantage to using this method over the *OPC? command is that the computer can perform other operations while it is waiting for the power meter to finish calibrating.

```
10 ASSIGN @Power TO 713
20 OUTPUT @Power;"*CLS"
30 OUTPUT @Power;"*ESE 1"
40 OUTPUT @Power;"CAL:AUTO ONCE;*OPC"
50 WHILE NOT BIT(SPOLL(@Power),5)
60 !(Computer carries out other operations here)
70 END WHILE
80 OUTPUT @Power;"MEAS:POW:AC?"
90 ENTER @Power;Result
100 PRINT Result
110 END
```

Saving and Recalling Power Meter Configurations

To reduce repeated programming, up to ten power meter configurations can be stored in the power meter's non-volatile memory. The error list, HP-IB address, programming language, sensor calibration table data, zeroing and calibration information are not stored.

How to Save and Recall a Configuration

Power meter configurations are saved and recalled with the following commands:

```
*SAV <NRf>
```

```
*RCL <NRf>
```

The range of values for <NRf> in the above commands is 1 to 10.

Example Program

```
10 ASSIGN @POWER TO 713
20 !Configure the power meter
30 OUTPUT @POWER;"UNIT:POW W"
40 OUTPUT @POWER;"SENS:CORR:LOSS2 -10"
50 OUTPUT @POWER;"SENS:CORR:LOSS2:STAT ON"
60 !Save the configuration
70 OUTPUT @POWER;"*SAV 5"
80 PRINT "Configuration Saved"
90 !Now reset the power meter
100 OUTPUT @POWER;"*RST"
110 !Recall the configuration
120 OUTPUT @POWER;"*RCL 5"
130 PRINT "Configuration Recalled"
140 PRINT "Save and Recall complete"
150 END
```

Using Device Clear to Halt Measurements

Device clear is an IEEE-488 low-level bus message which can be used to halt measurements in progress. Different programming languages and IEEE-488 interface cards provide access to this capability through their own unique commands. The status registers, the error queue, and all configuration states are left unchanged when a device clear message is received. Device clear performs the following actions.

- All measurements in progress are aborted.
- The power meter returns to the trigger "idle state".
- The power meter's input and output buffers are cleared.
- The power meter is prepared to accept a new command string.

An Introduction to the SCPI Language

Standard Commands for Programmable Instruments (SCPI) defines how you communicate with an instrument from a bus controller. The SCPI language uses a hierarchical structure similar to the file systems used by many bus controllers. The command tree is organized with root-level commands (also called subsystems) positioned at the top, with multiple levels below each root-level command. You must specify the complete path to execute the individual lower-level commands.

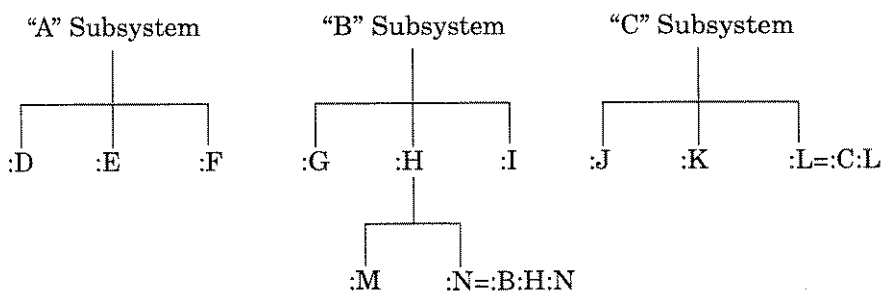

Mnemonic Forms

Each keyword has both a long and a short form. A standard notation is used to differentiate the short form keyword from the long form keyword. The long form of the keyword is shown, with the short form portion shown in uppercase characters, and the rest of the keyword shown in lowercase characters. For example, the short form of TRIGger is TRIG.

Using a Colon (:)

When a colon is the first character of a command keyword, it indicates that the next command mnemonic is a root-level command. When a colon is inserted between two command mnemonics, the colon moves the path down one level in the present path (for the specified root-level command) of the command tree. You *must* separate command mnemonics from each other using a colon. *You can omit the leading colon if the command is the first of a new program line.*

Using a Semicolon (;)

Use a semicolon to separate two commands within the same command string. The semicolon does not change the present path specified. For example, the following two statements are equivalent. Note that in the first statement the first colon is optional but the third is compulsory.

```
:DISP:FORM DIG;:DISP:RES 2  
:DISP:FORM DIG;RES 2
```

Using a Comma (,)

If a command requires more than one parameter, you must separate adjacent parameters using a comma.

Using Whitespace

You *must* use whitespace characters, [tab], or [space] to separate a parameter from a command keyword. Whitespace characters are generally ignored *only* in parameter lists.

Using “?” Commands

The bus controller may send commands at any time, but a SCPI instrument may only send responses when *specifically* instructed to do so. Only query commands (commands that end with a “?”) will instruct the instrument to send a response message. Queries return either measured values or internal instrument settings.

Note

If you send two query commands without reading the response from the first, then attempt to read the second response, you may receive some data from the first response followed by the complete second response. To avoid this, do not send a query command without reading the response. When you cannot avoid this situation, send a device clear before sending the second query command.

Using “*” Commands

Commands starting with a “*” are called common commands. They are required to perform the identical function for *all* instruments that are compliant with the IEEE-488.2 interface standard. The “*” commands are used to control reset, self-test, and status operations in the power meter.

Syntax Conventions

Throughout this guide, the following conventions are used for SCPI command syntax.

- Square brackets ([]) indicate optional keywords or parameters.
- Braces ({}) enclose one or more parameters that may be included zero or more times.
- Triangle brackets (<>) indicate that you must substitute a value for the enclosed parameter.
- Bars (|) can be read as “or” and are used to separate alternative parameter options.

Syntax Diagram Conventions

- Solid lines represent the recommended path.
- Ovals enclose command mnemonics. The command mnemonic must be entered exactly as shown.
- Dotted lines indicate an optional path for bypassing secondary keywords.
- Arrows and curved intersections indicate command path direction.

SCPI Data Types

The SCPI language defines different data formats for use in program messages and response messages. Instruments are flexible listeners and can accept commands and parameters in various formats. However, SCPI instruments are precise talkers. This means that SCPI instruments *always* respond to a particular query in a predefined, rigid format.

<Boolean> Definition

Throughout this chapter <Boolean> is used to represent ON|OFF|<Nrf>. Boolean parameters have a value of 0 or 1 and are unitless. ON corresponds to 1 and OFF corresponds to 0.

On input, an <Nrf> is rounded to an integer. A nonzero result is interpreted as 1.

Queries always return a 1 or 0, never ON or OFF.

<character response data> Definition

Throughout this chapter <character_data> is used to represent character data, that is, A - Z, a - z, 0 - 9 and _ (underscore). For example: START and R6_5F. The format is defined as:

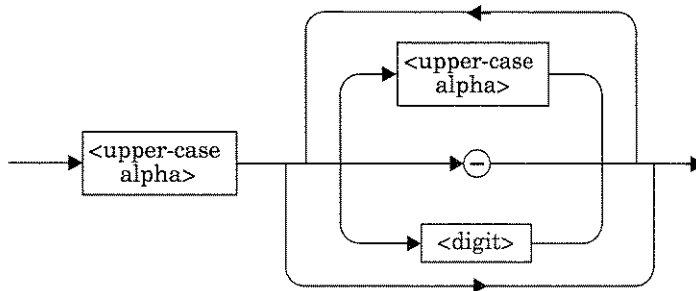

<NAN> Definition

Not a number (NAN) is represented as 9.91 E37. Not a number is defined in IEEE 754.

<non-decimal numeric>

Throughout this chapter <non-decimal numeric> is used to represent numeric information in bases other than ten (that is, hexadecimal, octal and binary). The following syntax diagram shows the standard for these three data structures. For example, #HA2F, #ha4e, #Q62, #q15, #B01011.

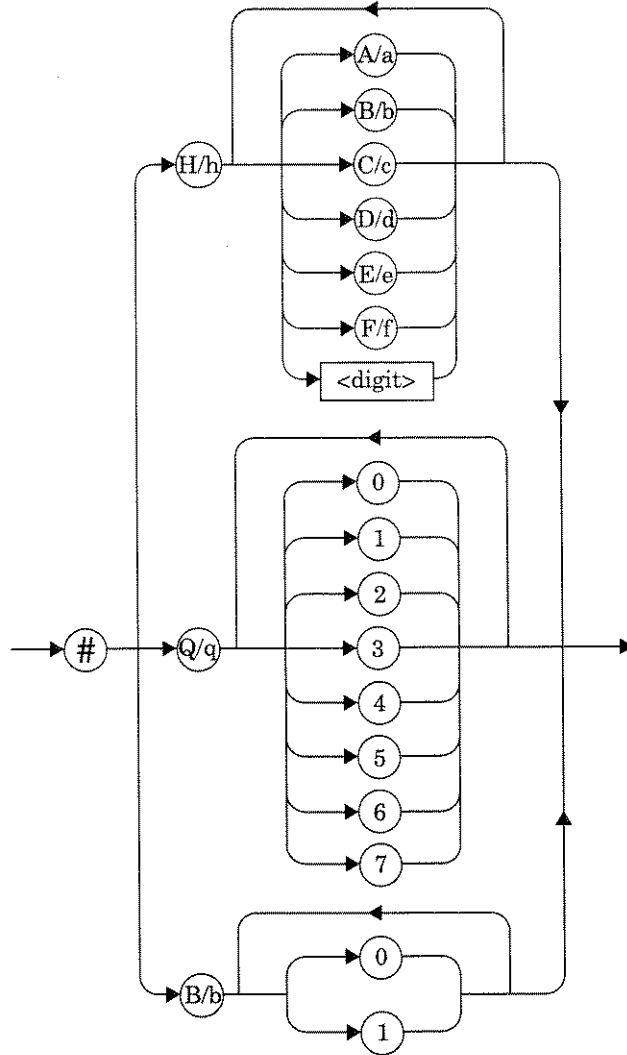

Refer to section 7.7.4.1 of IEEE 488.2 for further details.

<NRf> Definition

Throughout this chapter <NRf> is used to denote a flexible numeric representation. For example: +200; -56; +9.9E36. Refer to section 7.7.2.1 of IEEE 488.2 for further details.

<NR1> Definition

Throughout this chapter <NR1> numeric response data is defined as:

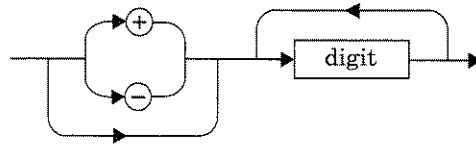

For example:

- 146
- +146
- -12345

Refer to section 8.7.2 of IEEE 488.2 for further details.

<NR2> Definition

Throughout this chapter <NR2> numeric response data is defined as:

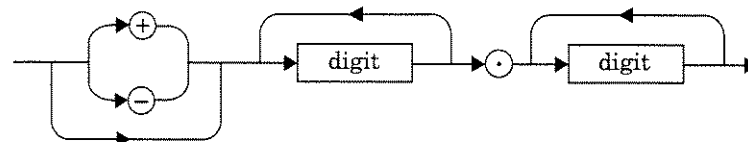

For example:

- 12.3
- +1.2345
- -0.123

Refer to section 8.7.3 of IEEE 488.2 for further details.

<NR3> Definition

Throughout this chapter <NR3> numeric response data is defined as:

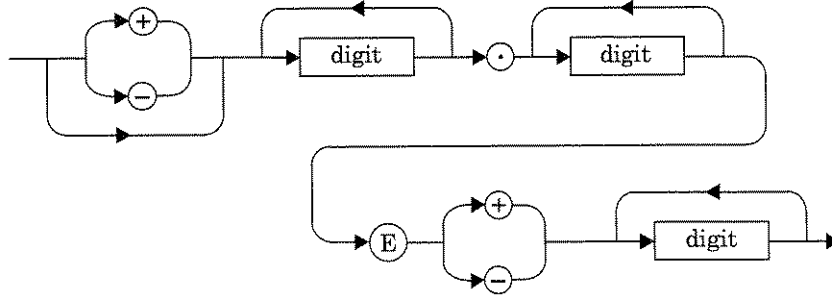

For example:

- 1.23E+6
- 123.4E-54
- -1234.567E+90.

Refer to section 8.7.4 of IEEE 488.2 for further details.

<numeric_value> Definition

Throughout this chapter the decimal numeric element is abbreviated to <numeric_value>. For example, <NRf>, MINimum, MAXimum, DEFault or Not A Number (NAN).

<string> Definition

Throughout this chapter <string> is used to represent 7-bit ASCII characters.

The format is defined as:

Program Data

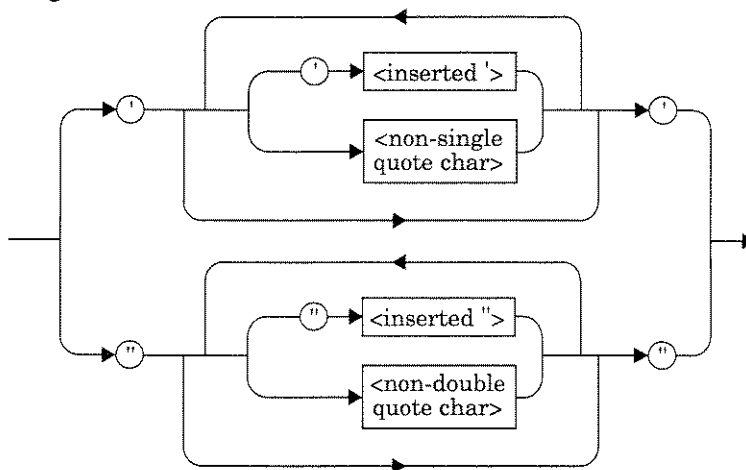

Response Data

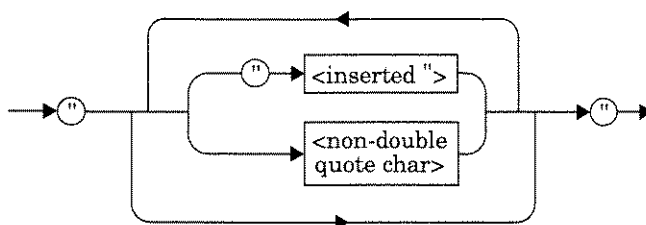

Input Message Terminators

Program messages sent to a SCPI instrument *must* terminate with a <newline> character. The IEEE.488 EOI (end or identify) signal is interpreted as a <newline> character and may also be used to terminate a message in place of the <newline> character. A <carriage return> followed by a <newline> is also accepted. Many programming languages allow you to specify a message terminator character or EOI state to be automatically sent with each bus transaction. Message termination *always* sets the current path back to the root-level.

Quick Reference

Note

This Guide details the commands available for both the HP EPM-441A and the HP EPM-442A power meters. As the HP EPM-441A is a single channel power meter only channel A can be selected. Where instances of channel selection are detailed in this chapter they are only relevant for the HP EPM-442A.

This section summarizes the SCPI (Standard Commands for Programmable Instruments) commands available to program the power meter. All the commands listed also have queries unless otherwise stated in the "Notes" column. Refer to later chapters for more details on each command.

In different subsystems the numeric suffix of program mnemonics can represent either a channel selection or a window selection. Refer to the appropriate command description to verify the meaning of the numeric suffix.

With commands that require you to specify a channel, Channel A is represented by a 1 and Channel B by a 2. If you omit the channel number, Channel A is assumed.

With commands that require you to specify a window, the upper window is represented by a 1 and the lower window by a 2. If you omit the window number, the upper window is assumed.

MEASurement Commands

Keyword	Parameter Form	Notes	Page
CONFigure[1 2]?		[query only]	page 2-6
CONFigure[1 2] [:SCALar]			
[:POWER:AC]	[<expected_value> [,<resolution>[,<source list>]]]	[no query]	page 2-9
:RELative	[<expected_value> [,<resolution>[,<source list>]]]	[no query]	page 2-11
:DIFFerence	[<expected_value> [,<resolution>[,<source list>]]]	[no query]	page 2-13
:RELative	[<expected_value> [,<resolution>[,<source list>]]]	[no query]	page 2-15
:RATio	[<expected_value> [,<resolution>[,<source list>]]]	[no query]	page 2-17
:RELative	[<expected_value> [,<resolution>[,<source list>]]]	[no query]	page 2-19
FETCH[1 2] [:SCALar]			
[:POWER:AC]?	[<expected_value> [,<resolution>[,<source list>]]]	[query only]	page 2-22
:RELative?	[<expected_value> [,<resolution>[,<source list>]]]	[query only]	page 2-24
:DIFFerence?	[<expected_value> [,<resolution>[,<source list>]]]	[query only]	page 2-27
:RELative?	[<expected_value> [,<resolution>[,<source list>]]]	[query only]	page 2-29
:RATio?	[<expected_value> [,<resolution>[,<source list>]]]	[query only]	page 2-31
:RELative?	[<expected_value> [,<resolution>[,<source list>]]]	[query only]	page 2-33
READ[1 2] [:SCALar]			
[:POWER:AC]?	[<expected_value> [,<resolution>[,<source list>]]]	[query only]	page 2-36
:RELative?	[<expected_value> [,<resolution>[,<source list>]]]	[query only]	page 2-38
:DIFFerence?	[<expected_value> [,<resolution>[,<source list>]]]	[query only]	page 2-41
:RELative?	[<expected_value> [,<resolution>[,<source list>]]]	[query only]	page 2-43
:RATio?	[<expected_value> [,<resolution>[,<source list>]]]	[query only]	page 2-45
:RELative?	[<expected_value> [,<resolution>[,<source list>]]]	[query only]	page 2-47
MEASure[1 2] [:SCALar]			
[:POWER:AC]?	[<expected_value> [,<resolution>[,<source list>]]]	[query only]	page 2-50

Keyword	Parameter Form	Notes	Page
:RELative?	{<expected_value> [,<resolution>[,<source list>]]}	[query only]	page 2-52
:DIFFerence?	{<expected_value> [,<resolution>[,<source list>]]}	[query only]	page 2-54
:RELative?	{<expected_value> [,<resolution>[,<source list>]]}	[query only]	page 2-56
:RATio?	{<expected_value> [,<resolution>[,<source list>]]}	[query only]	page 2-58
:RELative?	{<expected_value> [,<resolution>[,<source list>]]}	[query only]	page 2-60

CALCulate Subsystem

Keyword	Parameter Form	Notes	Page
CALCulate[1 2]			
:GAIN			
[:MAGNitude]	<numeric_value>		page 3-4
:STATE	<Boolean>		page 3-6
:MATH			
[:EXPReSSion]	<string>		page 3-8
:CATalog?		[query only]	page 3-10
:RELative			
[:MAGNitude]			
:AUTO	<Boolean> ONCE		page 3-12
:STATE	<Boolean>		page 3-14

CALibration Subsystem

Keyword	Parameter Form	Notes	Page
CALibration[1 2]			
[:ALL]		[event; no query]	page 4-3
[:ALL]?		[event;query]	page 4-5
:AUTO	<Boolean> ONCE		page 4-7
:RCFactor	<numeric_value>	[non-SCPI]	page 4-9
:ZERO			
:AUTO	<Boolean> ONCE		page 4-11

Power Meter Remote Operation
Quick Reference

DISPlay Subsystem

Keyword	Parameter Form	Notes	Page
DISPlay			
:CONTRast	<numeric_value>		page 5-3
:ENABle	<Boolean>		page 5-5
[:WINDow[1 2]]			
:FORMat	<character_data>	[non-SCPI]	page 5-7
:METer			
:LOWer	<numeric_value>	[non-SCPI]	page 5-10
:UPPer	<numeric_value>	[non-SCPI]	page 5-12
:RESolution	<numeric_value>	[non-SCPI]	page 5-14
:SElect		[non-SCPI]	page 5-16
[:STATe]	<Boolean>		page 5-17

FORMat Subsystem

Keyword	Parameter Form	Notes	Page
FORMat			
[:READings]			
:BORDer	NORMal SWAPped		page 6-3
[:DATA]	<Type>		page 6-3

MEMory Subsystem

Keyword	Parameter Form	Notes	Page
MEMory			
:CATalog			
[:ALL]?		[query only]	page 7-4
:STATe?		[query only]	page 7-6
:TABLE?		[query only]	page 7-7
:CLEar			
[:NAME]	<string>	[no query], [non-SCPI]	page 7-10
:TABLE		[no query]	page 7-11
:FRBE			
[:ALL]?		[query only]	page 7-13
:STATe?		[query only]	page 7-14
:TABLE?		[query only]	page 7-15
:NSTATes?		[query only]	page 7-16
:STATe			
:CATalog?		[query only]	page 7-18
:DEFine	<string> [, <numeric_value>]	[non-SCPI]	page 7-19
:TABLE			
:FREQuency	<numeric_value> [, <numeric_value>]		page 7-22
:POINTs?		[query only]	page 7-25
:GAIN			
[:MAGNitude]	<numeric_value> [, <numeric_value>]	[non-SCPI]	page 7-26
:POINTs?		[query only]	page 7-28
:MOVE	<string>, <string>	[no query]	page 7-29
:SElect	<string>	[non-SCPI]	page 7-30

OUTPut Subsystem

Keyword	Parameter Form	Notes	Page
OUTPut			
:ROSCillator			
[:STATe]	<Boolean>		page 8-3

Power Meter Remote Operation
Quick Reference

[SENSE] Subsystem

Keyword	Parameter Form	Notes	Page
[SENSE[1]] SENSE2			
:AVERage			
:COUNT	<numeric_value>		page 9-5
:AUTO	<Boolean>		page 9-7
[:STATe]	<Boolean>		page 9-10
:CORRection			
:CFACTOR GAIN1			
[:INPut]			
[:MAGNitude]	<numeric_value>		page 9-24
:CSET			
[:SElect]	<string>		page 9-13
:STATe	<Boolean>		page 9-15
:DCYCLE GAIN3		[non-SCPI]	
[:INPut]			
[:MAGNitude]	<numeric_value>		page 9-18
:STATe	<Boolean>		page 9-21
:GAIN2			
[:INPut]			
[:MAGNitude]	<numeric_value>		page 9-24
:STATe	<Boolean>		page 9-27
:LOSS2			
[:INPut]			
[:MAGNitude]	<numeric_value>		page 9-30
:STATe	<Boolean>		page 9-32
:FREQuency			
[:CW :FIXed]	<numeric_value>		page 9-34
:LIMit			
:CLEar			
:AUTO	<Boolean> ONCE		page 9-37
[:IMMediate]		[no query]	page 9-39
:FAIL?		[query only]	page 9-40
:FCOUNT?		[query only]	page 9-41
:LOWer			
[:DATA]	<numeric_value>		page 9-43
:STATe	<Boolean>		page 9-45
:UPPer			
[:DATA]	<numeric_value>		page 9-46
:POWER			
:AC			
:RANGE	<numeric_value>	[non-SCPI]	page 9-48
:AUTO	<Boolean>		page 9-49
:SPEed	<numeric_value>		page 9-51

STATUS Subsystem

As the status reporting commands are orthogonal, the same commands apply to all the registers. The registers are:

```

STATUS:DEVICE
STATUS:OPERATION
STATUS:OPERATION:CALibrating[:SUMMARY]
STATUS:OPERATION:LLFail[:SUMMARY]
STATUS:OPERATION:MEAsuring[:SUMMARY]
STATUS:OPERATION:SENSe[:SUMMARY]
STATUS:OPERATION:TRIGger[:SUMMARY]
STATUS:OPERATION:ULFail[:SUMMARY]
STATUS:QUESTionable
STATUS:QUESTionable:CALibration[:SUMMARY]
STATUS:QUESTionable:POWer[:SUMMARY]

```

The following five commands operate on each of these registers. However, to avoid duplication they are only listed once.

Keyword	Parameter Form	Notes	Page
:CONDition?		[query only]	page 10-4
:ENABle	<NRf> <non-decimal numeric>		page 10-5
[:EVENT?]		[query only]	page 10-4
:NTRansition	<NRf> <non-decimal numeric>		page 10-6
:PTRansition	<NRf> <non-decimal numeric>		page 10-7

Power Meter Remote Operation
Quick Reference

SYSTEM Subsystem

Keyword	Parameter Form	Notes	Page
SYSTEM			
:COMMunicate			
:GPIB			
[:SELF]			
:ADDRESS	<numeric_value>		page 11-3
:ERROR?		[query only]	page 11-4
:LANGUage	<character_data>		page 11-5
:PRESet		[event; no query]	page 11-6
:VERSion?		[query only]	page 11-9

TRIGger Subsystem

Keyword	Parameter Form	Notes	Page
ABORT[1 2]		[no query]	page 12-3
INITiate[1 2]			
[:IMMediate]			
:CONTinuous	<Boolean>	[no query]	page 12-5
TRIGger[1 2]			
:DELay			
:AUTO	<Boolean>	[no query]	page 12-9
[:IMMediate]			page 12-11
:SOURce	BUS IMM HOLD		page 12-12

UNIT Subsystem

Keyword	Parameter Form	Notes	Page
UNIT[1 2]			
:POWer	<amplitude unit>		page 13-3
:RATio	<ratio_unit>		page 13-6

SCPI Compliance Information

The power meter complies with the rules and regulations of the present version of SCPI (Standard Commands for Programmable Instruments). You can determine the SCPI version with which the power meter's is in compliance by sending the `SYSTem:VERSion?` command from the remote interface.

The following commands are device-specific to the HP EPM-441A/442A. They are not included in the 1996.0 version of the SCPI standard. However, these commands are designed with the SCPI format in mind and they follow all of the syntax rules of the standard.

```
CALibration[1|2]:RCFactor
DISPlay[:WINDow[1|2]]:FORMat
DISPlay[:WINDow[1|2]]:METer:LOWer
DISPlay[:WINDow[1|2]]:METer:UPPer
DISPlay[:WINDow[1|2]]:RESolution
DISPlay[:WINDow[1|2]]:SELEct
MEMory:CLEar[:NAME]
MEMory:TABLE:SELEct
MEMory:STATE:DEFine
MEMory:TABLE:GAIN[:MAGNitude]
MEMory:TABLE:GAIN:POINTs?
MEMory:TABLE:MOVE
[SENSE[1]]|SENSE2:CORRection:CFACTOR
[SENSE[1]]|SENSE2:CORRection:DCYCLE
[SENSE[1]]|SENSE2:SPEEd
[SENSE[1]]|SENSE2:POWER:AC:RANGE
UNIT[1|2]:POWER:RATIO
```

**Power Meter Remote Operation
SCPI Compliance Information**

2

MEASurement Instructions

MEASurement Instructions

The purpose of the MEASure group of instructions is to acquire data using a set of high level instructions.

The MEASure group of commands are structured to allow you to trade off interchangeability with fine control of the measurement process. MEASure? provides a complete capability where the power meter is configured, a measurement taken, and results returned in one operation. Often, more precise control of the measurement is required. Therefore, MEASure? is complemented by providing two commands, CONFigure and READ?. CONFigure performs the configuration portion of the measurement and READ? performs the data acquisition, postprocessing, and data output portions of the measurement. This allows you to perform a generic configuration of the measurement through CONFigure and then customize the measurement by changing particular power meter functions. The READ? then completes the measurement process.

READ?, in turn, is broken down into two additional commands, INITiate[:IMMediate] and FETCh?. INITiate[:IMMediate] performs the data acquisition. FETCh? performs the postprocessing function and returns the data. This allows you to perform several different FETCh? functions on a single set of acquired data.

The HP EPM-441A/442A power meters have several command extensions to the SCPI standard. These are the RELative and DIFFerence nodes.

The numeric suffixes of the CONFigure, FETCh, READ and MEASure? program mnemonics in the MEASure group of commands refers to windows, that is CONFigure1 and CONFigure2 represent the upper and lower windows respectively.

The Optional Parameters

All the MEASure commands have three optional parameters, an expected power value, a resolution and a source list.

Entering an `<expected_value>` parameter is only relevant if you are using an HP E-series power sensor. With HP 8480 series power sensors entering a value has no effect on the power meter. The value entered determines which of the power sensor's two ranges is used for the measurement. If the current setting of the power sensor's range is no longer valid for the new measurement, specifying the expected power value decreases the time taken to obtain a result.

The `<resolution>` parameter is used to set the resolution of the specified window. This parameter does not affect the resolution of the HP-IB data, however it does affect the auto averaging setting (refer to Figure 1-2 on page 1-39). In the case where a channel is set up in both the upper and lower window and the `<resolution>` parameter settings for these windows are different, the highest resolution setting is taken to calculate the averaging. If you are making a ratio or difference measurement the `<resolution>` parameters are applied to both channels.

The `<source list>` parameter is used to define:

- in a single channel measurement, what channel the measurement is to be made on.
- in a difference measurement whether the calculation is channel A-B or B-A.
- in a ratio measurement whether the calculation is A/B or B/A.

Entering a `<source list>` is only relevant if you are using an HP EPM-442A. As the HP EPM-441A only has a single channel the source list can only be channel A.

MEASurement Instructions
MEASurement Instructions

The commands associated with the MEASure group are:

Keyword	Parameter Form	Notes	Page
CONFigure[1 2]?		[query only]	page 2-6
CONFigure[1 2] [:SCALar]			
[:POWER:AC]	[<expected_value> [,<resolution>[,<source list>]]]	[no query]	page 2-9
:RELative	[<expected_value> [,<resolution>[,<source list>]]]	[no query]	page 2-11
:DIFFerence	[<expected_value> [,<resolution>[,<source list>]]]	[no query]	page 2-13
:RELative	[<expected_value> [,<resolution>[,<source list>]]]	[no query]	page 2-15
:RATio	[<expected_value> [,<resolution>[,<source list>]]]	[no query]	page 2-17
:RELative	[<expected_value> [,<resolution>[,<source list>]]]	[no query]	page 2-19
FETCH[1 2]			
[:SCALar]			
[:POWER:AC]?	[<expected_value> [,<resolution>[,<source list>]]]	[query only]	page 2-22
:RELative?	[<expected_value> [,<resolution>[,<source list>]]]	[query only]	page 2-24
:DIFFerence?	[<expected_value> [,<resolution>[,<source list>]]]	[query only]	page 2-27
:RELative?	[<expected_value> [,<resolution>[,<source list>]]]	[query only]	page 2-29
:RATio?	[<expected_value> [,<resolution>[,<source list>]]]	[query only]	page 2-31
:RELative?	[<expected_value> [,<resolution>[,<source list>]]]	[query only]	page 2-33
READ[1 2]			
[:SCALar]			
[:POWER:AC]?	[<expected_value> [,<resolution>[,<source list>]]]	[query only]	page 2-36
:RELative?	[<expected_value> [,<resolution>[,<source list>]]]	[query only]	page 2-38
:DIFFerence?	[<expected_value> [,<resolution>[,<source list>]]]	[query only]	page 2-41
:RELative?	[<expected_value> [,<resolution>[,<source list>]]]	[query only]	page 2-43
:RATio?	[<expected_value> [,<resolution>[,<source list>]]]	[query only]	page 2-45
:RELative?	[<expected_value> [,<resolution>[,<source list>]]]	[query only]	page 2-47

MEASurement Instructions
MEASurement Instructions

Keyword	Parameter Form	Notes	Page
MEASure[1 2] [:SCALar] [:POWER:AC]?	[<expected_value> [,<resolution>[,<source list>]]]	[query only]	page 2-50
:RELative?	[<expected_value> [,<resolution>[,<source list>]]]	[query only]	page 2-52
:DIFference?	[<expected_value> [,<resolution>[,<source list>]]]	[query only]	page 2-54
:RELative?	[<expected_value> [,<resolution>[,<source list>]]]	[query only]	page 2-56
:RATio?	[<expected_value> [,<resolution>[,<source list>]]]	[query only]	page 2-58
:RELative?	[<expected_value> [,<resolution>[,<source list>]]]	[query only]	page 2-60

CONFigure[1|2]?

This query returns the present configuration of the specified window.

Syntax

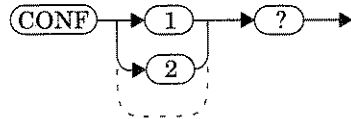

The string returned depends on the setting of the **CALCulate:MATH** and **CALCulate:RELative:STATe** commands.

The configuration is returned as a quoted string in the following format:

"<function> <expected_value>, <resolution>, <source list>"

CALCulate:MATH	CALCulate:RELative:STATe	Function	<source list>
(SENSe1)	OFF	:POW:AC	(@1)
(SENSe2) ¹	OFF	:POW:AC	(@2)
(SENSe1)	ON	:POW:AC:REL	(@1)
(SENSe2) ¹	ON	:POW:AC:REL	(@2)
(SENSe1 - SENSe2) ¹	OFF	:POW:AC:DIFF	(@1),(@2)
(SENSe2 - SENSe1) ¹	OFF	:POW:AC:DIFF	(@2),(@1)
(SENSe1 - SENSe2) ¹	ON	:POW:AC:DIFF:REL	(@1),(@2)
(SENSe2 - SENSe1) ¹	ON	:POW:AC:DIFF:REL	(@2),(@1)
(SENSe1 / SENSe2) ¹	OFF	:POW:AC:RAT	(@1),(@2)
(SENSe2 / SENSe1) ¹	OFF	:POW:AC:RAT	(@2),(@1)
(SENSe1 / SENSe2) ¹	ON	:POW:AC:RAT:REL	(@1),(@2)
(SENSe2 / SENSe1) ¹	ON	:POW:AC:RAT:REL	(@2),(@1)

1. HP EPM-442A only.

<expected_value> returns the expected value sent by the last **CONFigure** command or +20 dBm by default. Note that when the display is showing dual windows this value is meaningless.

The <resolution> returned is the same as the value returned by **DISPlay:WINDow:RESolution?**. The format of the return is <NR1> in the range 1 through 4.

Example

CONF2?

This command queries the current configuration of the lower window.

Reset Condition

On reset,

- the command function is set to :POWER:AC.
- the expected power level is set to +20 dBm.
- the resolution is set to 3.
- the source list
 - on the HP EPM-441A is set to channel A on both windows.
 - on the HP EPM-442A is set to channel A on the upper window and channel B on the lower window.

CONFigure[1|2] Commands

The CONFigure commands are used on the specified window to set,

- the expected power level value of the measurement.
- the resolution of the window.
- the channel(s) on which the measurement is to be made.

The CONFigure commands do not make the power measurement after setting the configuration. Use READ?, or alternatively use INITiate followed by a FETCh? to make the measurement.

The CONFigure command also does the following to the channel(s) which are in the specified window (the channel(s) in the window are specified in the <source list> parameter):

INITiate:CONTInuous OFF	Sets the power meter to make one trigger cycle when INITiate is sent.
TRIGger:SOURce IMMEDIATE	Sets the power meter to make the measurement immediately a trigger is received.
TRIGger:DELay:AUTO ON	Enables automatic delay before making the measurement.
SENSE:AVERAge:COUNT:AUTO ON	Enables automatic filter length selection.
SENSE:AVERAge:STATe ON	Enables averaging.

CONFigure[1|2][[:SCALar]][:POWer:AC] [<expected_value>[,<resolution>[,<source list>]]]

CONFigure[1|2][[:SCALar]][:POWer:AC] [<expected_value>[,<resolution>[,<source list>]]]

This command is used on the specified window, to set:

- the expected power level value of the measurement.
- the resolution of the window.
- the channel on which the measurement is to be made.

Syntax

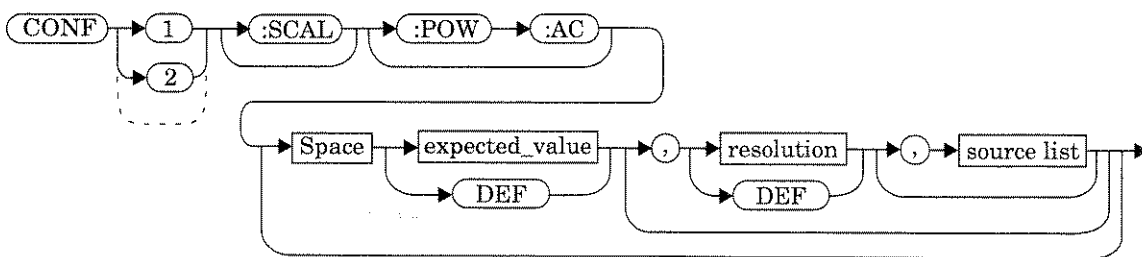

CONFigure[1|2][:SCALar][:POWER:AC] [<expected_value>,<resolution>,<source list>]]]

Parameters

Refer to “The Optional Parameters”, on page 2-3 for additional details on the parameters in this command.

Item	Description/Default	Range of Values
expected_value (for the expected power level)	A numeric value for the expected power level. The units of measurement are dBm and W. The default units are defined by UNIT:POWER.	sensor dependent DEF ¹
resolution	A numeric value for the resolution. If unspecified the current resolution setting is used.	1 to 4 ² 1.0, 0.1, 0.01, 0.001 DEF ¹
source list	This is the channel on which the command is implemented. If unspecified the current window setup is used. However, on the HP EPM-442A, if the window shows a ratio or difference measurement, the upper window defaults to channel A and the lower window to channel B.	(@1) (@2) (HP EPM-442A only)

1. The mnemonic DEF means DEFault. This is not equivalent to the DEFault parameter used in the command sub-systems. The parameters must be entered in the specified order. If parameters are omitted, they will default from the right. The parameter DEFault is used as a place holder. Specifying DEF leaves the parameter value unchanged.

2. When the measurement result is linear this parameter represents the number of significant digits. When the measurement result is logarithmic 1 to 4 represents a resolution of 1, 0.1, 0.01 and 0.001 respectively.

Example

CONF1:POW:AC DEF,2,(@1)

This command configures the upper window to measure the power of channel A, using the current sensor range and a resolution setting of 2.

CONFigure[1|2][[:SCALar][:POWER:AC]:RELative [<expected_value>[,<resolution>[,<source list>]]]

CONFigure[1|2][[:SCALar][:POWER:AC]:RELative
[<expected_value>[,<resolution>[,<source list>]]]

This command is used to set the measurement function, range and resolution of the specified window. It sets the measurement function to single channel with relative mode on. The relative value used is that set by the CALCulate:RELative:MAGNitude:AUTO command.

Syntax

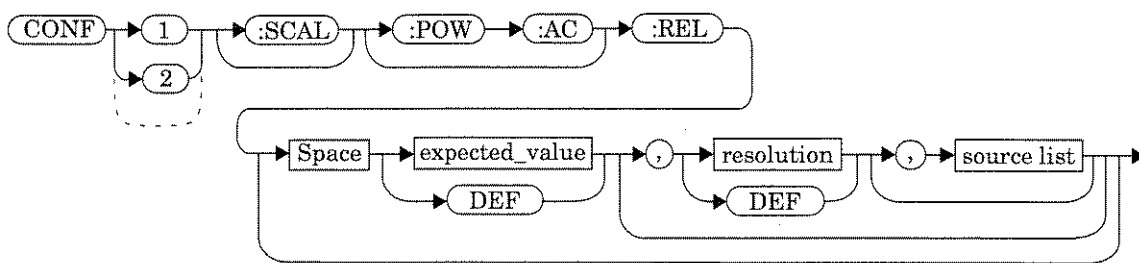

Parameters

Refer to “The Optional Parameters”, on page 2-3 for additional details on the parameters in this command.

Item	Description/Default	Range of Values
expected_value (for the expected power level)	A numeric value for the expected power level. The units of measurement are dBm and W. The default units are defined by UNIT:POWER.	sensor dependent DEF ¹
resolution	A numeric value for the resolution. If unspecified the current resolution setting is used.	1 to 4 ² 1.0, 0.1, 0.01, 0.001 DEF ¹

CONFigure[1|2][:SCALar][:POWer:AC]:RELative [<expected_value>[,<resolution>[,<source list>]]]

Item	Description/Default	Range of Values
source list	This is the channel on which the command is implemented. If unspecified the current window setup is used. However, on the HP EPM-442A, if the window shows a ratio or difference measurement, the upper window defaults to channel A and the lower window to channel B.	(@1) (@2) (HP EPM-442A only)

1. The mnemonic DEF means DEFault. This is not equivalent to the DEFault parameter used in the command sub-systems. The parameters must be entered in the specified order. If parameters are omitted, they will default from the right. The parameter DEFault is used as a place holder. Specifying DEF leaves the parameter value unchanged.
2. When the measurement result is linear this parameter represents the number of significant digits. When the measurement result is logarithmic 1 to 4 represents a resolution of 1, 0.1, 0.01 and 0.001 respectively.

Example

CONF2:REL -50DBM, 3, (@1)

This command configures the lower window to measure the relative power of channel A, using an expected power level of -50 dBm and a resolution setting of 3.

CONFigure[1|2][[:SCALar][:POWer:AC]:DIFFerence [<expected_value>[,<resolution>[,<source list>]]]

CONFigure[1|2][[:SCALar][:POWer:AC]:DIFFerence
[<expected_value>[,<resolution>[,<source list>]]]

This command is only relevant for the HP EPM-442A power meter.

This command is used to set the measurement function and resolution of the specified window. It sets the measurement function to difference with relative mode off.

Syntax

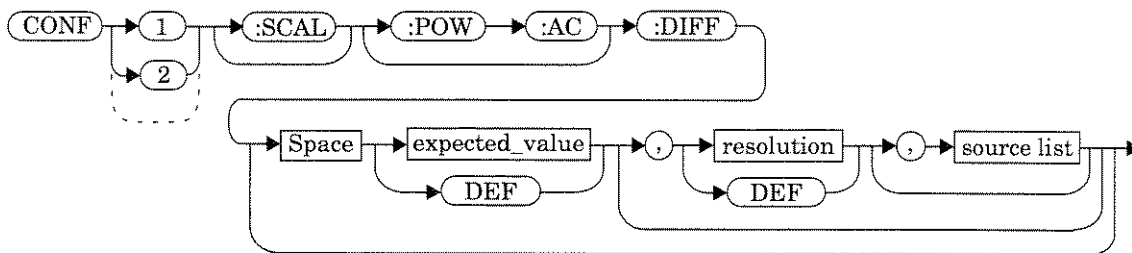

Parameters

Refer to “The Optional Parameters”, on page 2-3 for additional details on the parameters in this command.

Item	Description/Default	Range of Values
expected_value (for the expected power level)	The power meter ignores the numeric value entered in this parameter. Any value entered is treated like DEF.	sensor dependent DEF ¹
resolution	A numeric value for the resolution. If unspecified the current resolution setting is used.	1 to 4 ² 1.0, 0.1, 0.01, 0.001 DEF ¹

CONFigure[112][:SCALar][:POWer:AC]:DIFFerence [<expected_value>[,<resolution>[,<source list>]]]

Item	Description/Default	Range of Values
source list	This channel list specifies between which channels the difference is calculated. If unspecified and the current window setup is a difference measurement then this difference setup is used, otherwise it defaults to channel A-B.	(@1),(@2) (@2),(@1)

1. The mnemonic DEF means DEFault. This is not equivalent to the DEFault parameter used in the command sub-systems. The parameters must be entered in the specified order. If parameters are omitted, they will default from the right. The parameter DEFault is used as a place holder. Specifying DEF leaves the parameter value unchanged.
2. When the measurement result is linear this parameter represents the number of significant digits. When the measurement result is logarithmic 1 to 4 represents a resolution of 1, 0.1, 0.01 and 0.001 respectively.

Example

CONF2:DIFF DEF,1,(@2),(@1)

This command configures the lower window to make a difference measurement of channel B - channel A, using the current sensor range and a resolution of 1 on both channels.

**CONFigure[1|2][[:SCALar][:POWer:AC]:DIFFerence:RELative
 [<expected_value>[,<resolution>[,<source list>]]]**

This command is only relevant for the HP EPM-442A power meter.

This command is used to set the measurement function, range and resolution of the specified window. It sets the measurement function to difference with relative mode on. The relative value used is that set by the CALCulate:RELative:MAGNitude:AUTO command.

Syntax

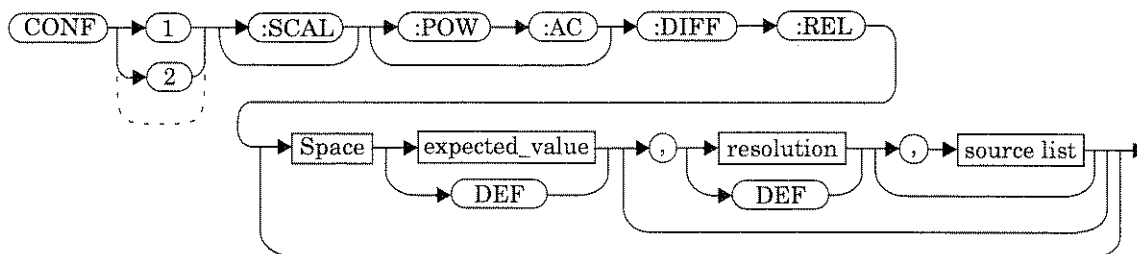

Parameters

Refer to “The Optional Parameters”, on page 2-3 for additional details on the parameters in this command.

Item	Description/Default	Range of Values
expected_value (for the expected power level)	The power meter ignores the numeric value entered in this parameter. Any value entered is treated like DEF.	sensor dependent DEF ¹
resolution	A numeric value for the resolution. If unspecified the current resolution setting is used.	1 to 4 ² 1.0, 0.1, 0.01, 0.001 DEF ¹

MEASurement Instructions
CONFigure[112][:SCALar][:POWer:AC]:DIFFerence:RELative
 [<expected_value>[,<resolution>[,<source list>]]]

Item	Description/Default	Range of Values
source list	This channel list specifies between which channels the difference is calculated. If unspecified and the current window setup is a difference measurement then this difference setup is used, otherwise it defaults to channel A-B.	(@1),(@2) (@2),(@1)

1. The mnemonic DEF means DEFault. This is not equivalent to the DEFault parameter used in the command sub-systems. The parameters must be entered in the specified order. If parameters are omitted, they will default from the right. The parameter DEFault is used as a place holder. Specifying DEF leaves the parameter value unchanged.
2. When the measurement result is linear this parameter represents the number of significant digits. When the measurement result is logarithmic 1 to 4 represents a resolution of 1, 0.1, 0.01 and 0.001 respectively.

Example

`CONF1:DIFF:REL DEF,1,(@1),(@2)` *This command configures the upper window to make a difference measurement of channel A - channel B with relative mode on, using the current sensor range and a resolution of 1 on both channels.*

CONFigure[112][[:SCALar][:POWer:AC]:RATio [<expected_value>[,<resolution>[,<source list>]]]

CONFigure[112][[:SCALar][:POWer:AC]:RATio
 [<expected_value>[,<resolution>[,<source list>]]]

This command is only relevant for the HP EPM-442A power meter.

This command is used to set the measurement function, range and resolution of the specified window. It sets the measurement function to ratio with relative mode off.

Syntax

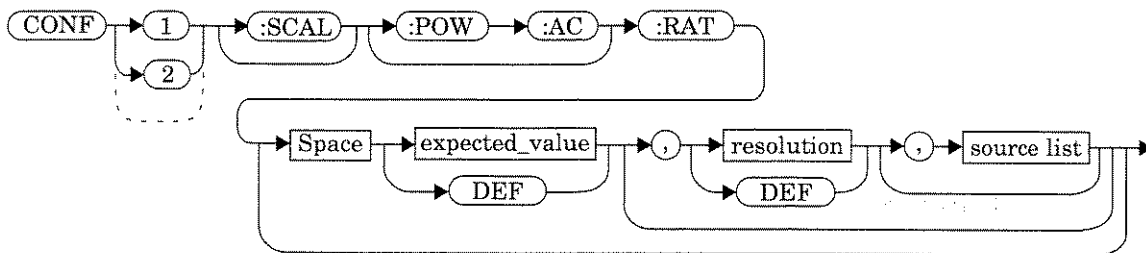

Parameters

Refer to “The Optional Parameters”, on page 2-3 for additional details on the parameters in this command.

Item	Description/Default	Range of Values
expected_value (for the expected power level)	The power meter ignores the numeric value entered in this parameter. Any value entered is treated like DEF.	sensor dependent DEF ¹
resolution	A numeric value for the resolution. If unspecified the current resolution setting is used.	1 to 4 ² 1.0, 0.1, 0.01, 0.001 DEF ¹

CONFigure[1|2][[:SCALar][[:POWER:AC]:RATio [<expected_value>[,<resolution>[,<source list>]]]

Item	Description/Default	Range of Values
source list	This channel list specifies between which channels the ratio is calculated. If unspecified and the current window setup is a ratio measurement then this ratio setup is used, otherwise it defaults to channel A/B.	(@1),(@2) (@2),(@1)

1. The mnemonic DEF means DEFault. This is not equivalent to the DEFault parameter used in the command sub-systems. The parameters must be entered in the specified order. If parameters are omitted, they will default from the right. The parameter DEFault is used as a place holder. Specifying DEF leaves the parameter value unchanged.
2. When the measurement result is linear this parameter represents the number of significant digits. When the measurement result is logarithmic 1 to 4 represents a resolution of 1, 0.1, 0.01 and 0.001 respectively.

Example

CONF1:RAT DEF, 4, (@1), (@2)

This command configures the upper window to make a ratio measurement of channel A over channel B, using the current sensor range and a resolution setting of 4 on both channels.

CONFigure[1|2][:SCALar][:POWer:AC]:RATio:RELative [<expected_value>[,<resolution>[,<source list>]]]

CONFigure[1|2][:SCALar][:POWer:AC]:RATio:RELative
[<expected_value>[,<resolution>[,<source list>]]]

This command is only relevant for the HP EPM-442A power meter.

This command is used to set the measurement function, range and resolution of the specified window. It sets the measurement function to ratio with relative mode on. The relative value used is that set by the CALCulate:RELative:MAGNitude:AUTO command.

Syntax

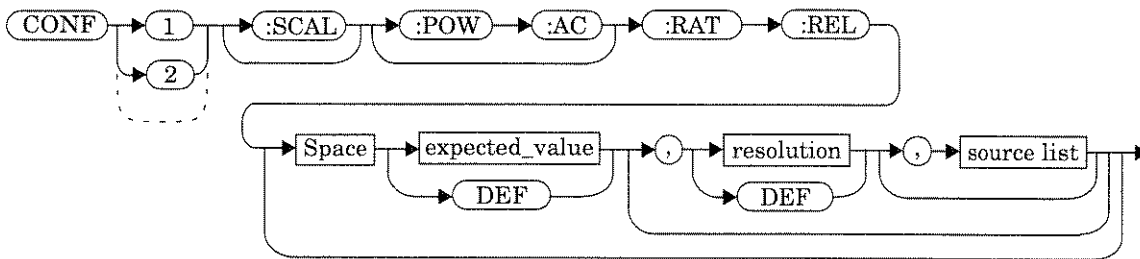

Parameters

Refer to “The Optional Parameters”, on page 2-3 for additional details on the parameters in this command.

Item	Description/Default	Range of Values
expected_value (for the expected power level)	The power meter ignores the numeric value entered in this parameter. Any value entered is treated like DEF.	sensor dependent DEF ¹
resolution	A numeric value for the resolution. If unspecified the current resolution setting is used.	1 to 4 ² 1.0, 0.1, 0.01, 0.001 DEF ¹

MEASurement Instructions

CONFigure[1|2][:SCALar][:POWer:AC]:RATio:RELative [<expected_value>,<resolution>,<source list>]]

Item	Description/Default	Range of Values
source list	This channel list specifies between which channels the ratio is calculated. If unspecified and the current window setup is a ratio measurement then this ratio setup is used, otherwise it defaults to channel A/B.	(@1),(@2) (@2),(@1)

1. The mnemonic DEF means DEFault. This is not equivalent to the DEFault parameter used in the command sub-systems. The parameters must be entered in the specified order. If parameters are omitted, they will default from the right. The parameter DEFault is used as a place holder. Specifying DEF leaves the parameter value unchanged.
2. When the measurement result is linear this parameter represents the number of significant digits. When the measurement result is logarithmic 1 to 4 represents a resolution of 1, 0.1, 0.01 and 0.001 respectively.

Example

CONF1:RAT:REL DEF,1,(@1),(@2)

This command configures the upper window to make a ratio measurement of channel A over channel B with relative mode on, using the current sensor range and a resolution setting of 1 on both channels.

FETCh[1|2] Queries

The FETCh? queries set the specified window's measurement function to either single channel, difference or ratio measurements with relative mode either off or on. They then recalculate the measurement and place the result on the bus. The format of the return is <NR3>, for example, -6.98970004E-001.

The query returns a measurement result whenever it is valid. The measurement result becomes invalid under the following conditions:

- When *RST is executed.
- Whenever a measurement is initiated.
- When any SENSE parameter, such as frequency, is changed.

If data is invalid, the FETCh? query is not completed until all data is valid. The exceptions to this are, if the power meter is in the idle state and the data is invalid, or the power meter has been reconfigured as defined above and no new measurement has been initiated. In such cases, the FETCh? routine generates the error -230, "Data corrupt or stale" and no result is returned. A common cause for this error is receiving a FETCh? after a *RST. If the expected value and resolution parameters are not the same as those that were used to collect the data, error -221, "Settings conflict" occurs.

FETCH[1|2][:SCALar][:POWER:AC]? [<expected_value>[,<resolution>[,<source list>]]]

FETCH[1|2][:SCALar][:POWER:AC]? [<expected_value>[,<resolution>[,<source list>]]]

This command sets the specified window's measurement function to single channel with relative mode off, recalculates the measurement and places the result on the bus. The result is a power based measurement and is expressed in the units defined by `UNIT[1|2]:POWER`.

Syntax

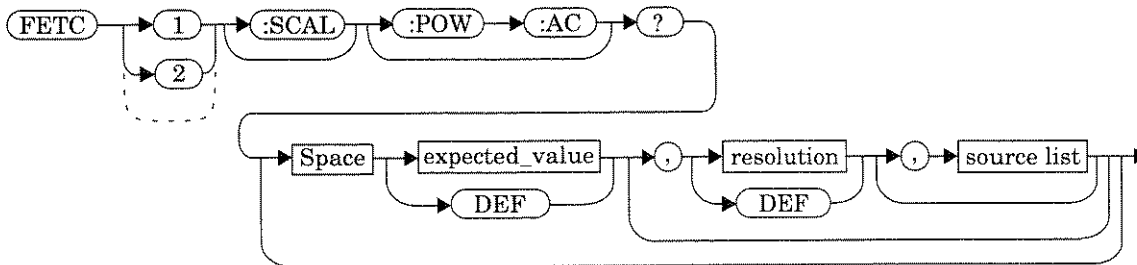

Parameters

Refer to “The Optional Parameters”, on page 2-3 for additional details on the parameters in this command.

Item	Description/Default	Range of Values
expected_value (for the expected power level)	The expected power level parameter can be set to DEF or a numeric value. If a value is entered it should correspond to that set by CONFIGure otherwise an error occurs. The units of measurement are dBm and W. The default units are defined by UNIT:POWER.	sensor dependent DEF ¹
resolution	A numeric value for the resolution. If it is unspecified the current resolution setting is used. If a value is entered it should correspond to the current resolution setting otherwise an error occurs.	1 to 4 ² 1.0, 0.1, 0.01, 0.001 DEF ¹

FETCh[1|2][[:SCALAr][[:POWER:AC]? [<expected_value>[,<resolution>[,<source list>]]]]

Item	Description/Default	Range of Values
source list	This is the channel on which the command is implemented. If unspecified the current window setup is used. However, on the HP EPM-442A, if the window shows a ratio or difference measurement, the upper window defaults to channel A and the lower window to channel B.	(@1) (@2) (HP EPM-442A only)

1. The mnemonic DEF means DEFault. This is not equivalent to the DEFault parameter used in the command sub-systems. The parameters must be entered in the specified order. If parameters are omitted, they will default from the right. The parameter DEFault is used as a place holder. Specifying DEF leaves the parameter value unchanged.

2. When the measurement result is linear this parameter represents the number of significant digits. When the measurement result is logarithmic 1 to 4 represents a resolution of 1, 0.1, 0.01 and 0.001 respectively.

Example

FETC2 : POW : AC ?

This command queries the lower window's measurement result.

Error Messages

If the last measurement is not valid error -230, "Data corrupt or stale" occurs. A measurement is valid after it has been initiated. It becomes invalid when either a reset occurs or any measurement parameter, for example frequency, is changed.

If the expected value and resolution parameters are not the same as the current expected value and resolution setting on the specified window, error -221, "Settings conflict" occurs.

FETCH[1|2][:SCALar][:POWer:AC]:RELative? [<expected_value>,<resolution>,<source list>]]

FETCH[1|2][:SCALar][:POWer:AC]:RELative?
[<expected_value>,<resolution>,<source list>]]

This command sets the specified window's measurement function to single channel with relative mode on, recalculates the measurement and places the results on the bus. The result is a ratio based measurement and is expressed in the units defined by `UNIT[1|2]:POWer:RATio`. The relative value used is that set by the `CALCulate:RELative:MAGNitude:AUTO` command.

Syntax

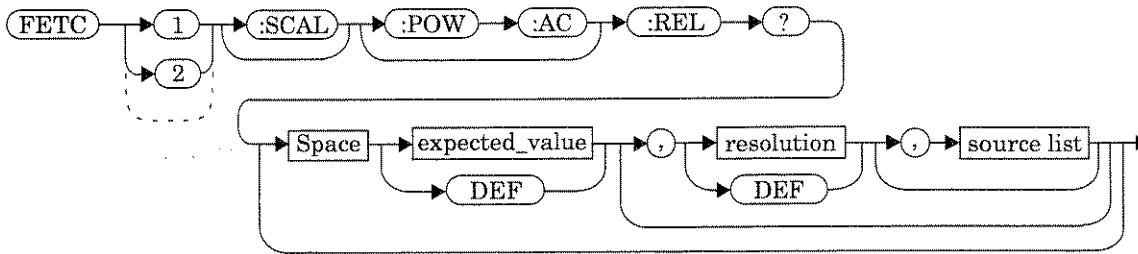

Parameters

Refer to “The Optional Parameters”, on page 2-3 for additional details on the parameters in this command.

Item	Description/Default	Range of Values
expected_value (for the expected power level)	The expected power level parameter can be set to DEF or a numeric value. If a value is entered it should correspond to that set by <code>CONFigure</code> otherwise an error occurs. The units of measurement are dBm and W. The default units are defined by <code>UNIT:POWer</code> . The default value is +20 dBm.	sensor dependent DEF ¹

FETCh[1|2][[:SCALar][[:POWER:AC]:RELative? [<expected_value>[,<resolution>[,<source list>]]]

Item	Description/Default	Range of Values
resolution	A numeric value for the resolution. If it is unspecified the current resolution setting is used. If a value is entered it should correspond to the current resolution setting otherwise an error occurs.	1 to 4 ² 1.0, 0.1, 0.01, 0.001 DEF ¹
source list	This is the channel on which the command is implemented. If unspecified the current window setup is used. However, on the HP EPM-442A, if the window shows a ratio or difference measurement, the upper window defaults to channel A and the lower window to channel B.	(@1) (@2)

1. The mnemonic DEF means DEFault. This is not equivalent to the DEFault parameter used in the command sub-systems. The parameters must be entered in the specified order. If parameters are omitted, they will default from the right. The parameter DEFault is used as a place holder. Specifying DEF leaves the parameter value unchanged.

2. When the measurement result is linear this parameter represents the number of significant digits. When the measurement result is logarithmic 1 to 4 represents a resolution of 1, 0.1, 0.01 and 0.001 respectively.

Example

```
FETC1:REL? DEF,2,(@2)
```

This command queries the upper window's relative measurement of channel B, using the current sensor range and a resolution setting of 2.

MEASurement Instructions

FETCh[112][:SCALar][:POWer:AC]:RELative? [<expected_value>[,<resolution>[,<source list>]]]

Error Messages

If the last measurement is not valid error -230, "Data corrupt or stale" occurs. A measurement is valid after it has been initiated. It becomes invalid when either a reset occurs or any measurement parameter, for example frequency, is changed.

If the expected value and resolution parameters are not the same as the current expected value and resolution settings on the specified window, error -221, "Settings conflict" occurs.

FETCh[1|2][:SCALar][:POWer:AC]:DIFFerence? [<expected_value>[,<resolution>[,<source list>]]]

FETCh[1|2][:SCALar][:POWer:AC]:DIFFerence?
 [<expected_value>[,<resolution>[,<source list>]]]

This command is only relevant for the HP EPM-442A power meter.

This command sets the specified window's measurement function to power difference with relative mode off, recalculates the measurement and places the results on the bus. The result is a power based measurement and is expressed in the units defined by UNIT[1|2]:POWer.

Syntax

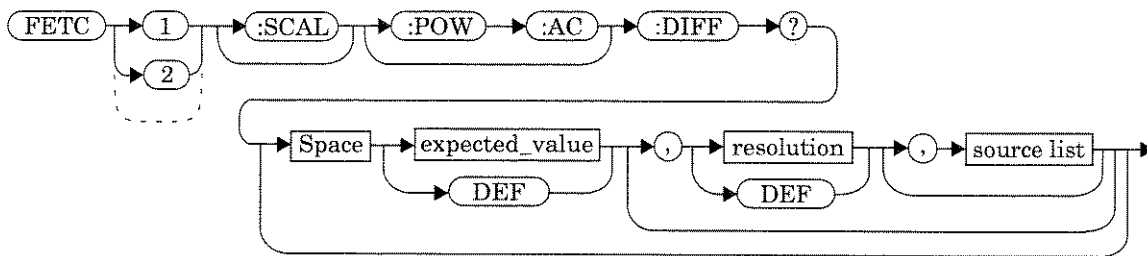

Parameters

Refer to “The Optional Parameters”, on page 2-3 for additional details on the parameters in this command.

Item	Description/Default	Range of Values
expected_value (for the expected power level)	The power meter ignores the numeric value entered in this parameter. Any value entered is treated like DEF.	sensor dependent DEF ¹
resolution	A numeric value for the resolution. If it is unspecified the current resolution setting is used. If a value is entered it should correspond to the current resolution setting otherwise an error occurs.	1 to 4 ² 1.0, 0.1, 0.01, 0.001 DEF ¹

MEASurement Instructions

FETCh[1|2][:SCALar][:POWER:AC]:DIFFerence? [<expected_value>[,<resolution>[,<source list>]]]

Item	Description/Default	Range of Values
source list	This channel list specifies between which channels the difference is calculated. If unspecified and the current window setup is a difference measurement then this difference setup is used, otherwise it defaults to channel A-B.	(@1),(@2) (@2),(@1)

1. The mnemonic DEF means DEFault. This is not equivalent to the DEFault parameter used in the command sub-systems. The parameters must be entered in the specified order. If parameters are omitted, they will default from the right. The parameter DEFault is used as a place holder. Specifying DEF leaves the parameter value unchanged.
2. When the measurement result is linear this parameter represents the number of significant digits. When the measurement result is logarithmic 1 to 4 represents a resolution of 1, 0.1, 0.01 and 0.001 respectively.

Example

FETC2 :DIFF?

This command queries the difference measurement on the lower window.

Error Messages

If the last measurement on either channel is not valid error -230, "Data corrupt or stale" occurs. A measurement is valid after it has been initiated. It becomes invalid when either a reset occurs or any measurement parameter, for example frequency, is changed.

If the resolution parameter is not the same as the current resolution setting on the specified window, error -221, "Settings conflict" occurs.

FETCh[1|2][[:SCALar][:POWer:AC]:DIFFerence:RELative? [<expected_value>[,<resolution>[,<source list>]]]

FETCh[1|2][[:SCALar][:POWer:AC]:DIFFerence:RELative? [<expected_value>[,<resolution>[,<source list>]]]

This command is only relevant for the HP EPM-442A power meter.

This command sets the specified window's measurement function to power difference with relative mode on, recalculates the measurement and places the results on the bus. The result is a ratio based measurement and is expressed in the units defined by UNIT[1|2]:POWer:RATio. The relative value used is that set by the CALCulate:RELative:MAGNitude:AUTO command.

Syntax

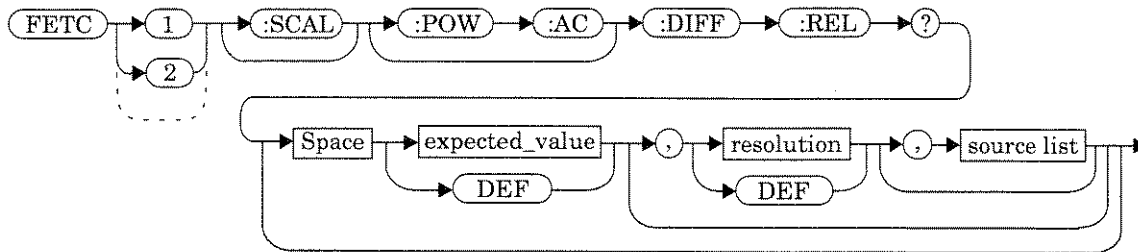

Parameters

Refer to “The Optional Parameters”, on page 2-3 for additional details on the parameters in this command.

Item	Description/Default	Range of Values
expected_value (for the expected power level)	The power meter ignores the numeric value entered in this parameter. Any value entered is treated like DEF.	sensor dependent DEF ¹
resolution	A numeric value for the resolution. If it is unspecified the current resolution setting is used. If a value is entered it should correspond to the current resolution setting otherwise an error occurs.	1 to 4 ² 1.0, 0.1, 0.01, 0.001 DEF ¹

MEASurement Instructions

FETCh[1|2][[:SCALAr]][:POWer:AC]:DIFFerence:RELative? [<expected_value>[,<resolution>[,<source list>]]]

Item	Description/Default	Range of Values
source list	This channel list specifies between which channels the difference is calculated. If unspecified and the current window setup is a difference measurement then this difference setup is used, otherwise it defaults to channel A-B.	(@1),(@2) (@2),(@1)

1. The mnemonic DEF means DEFault. This is not equivalent to the DEFault parameter used in the command sub-systems. The parameters must be entered in the specified order. If parameters are omitted, they will default from the right. The parameter DEFault is used as a place holder. Specifying DEF leaves the parameter value unchanged.
2. When the measurement result is linear this parameter represents the number of significant digits. When the measurement result is logarithmic 1 to 4 represents a resolution of 1, 0.1, 0.01 and 0.001 respectively.

Example

FETC1:DIFF:REL? DEF,3,(@2),(@1)

This command queries the upper window's relative difference measurement of channel B - channel A, using the current sensor range and a resolution setting of 3 on both channels.

Error Messages

If the last measurement on either channel is not valid error -230, "Data corrupt or stale" occurs. A measurement is valid after it has been initiated. It becomes invalid when either a reset occurs or any measurement parameter, for example frequency, is changed.

If the resolution parameter is not the same as the current resolution setting on the specified window, error -221, "Settings conflict" occurs.

FETCh[1|2][:SCALar][:POWer:AC]:RATio? [<expected_value>[,<resolution>[,<source list>]]]

FETCh[1|2][:SCALar][:POWer:AC]:RATio?

[<expected_value>[,<resolution>[,<source list>]]]

This command is only relevant for the HP EPM-442A power meter.

This command sets the specified window's measurement function to power ratio with relative mode off, recalculates the measurement and places the results on the bus. The result is a ratio based measurement and is expressed in the units defined by UNIT[1|2]:POWER:RATio.

Syntax

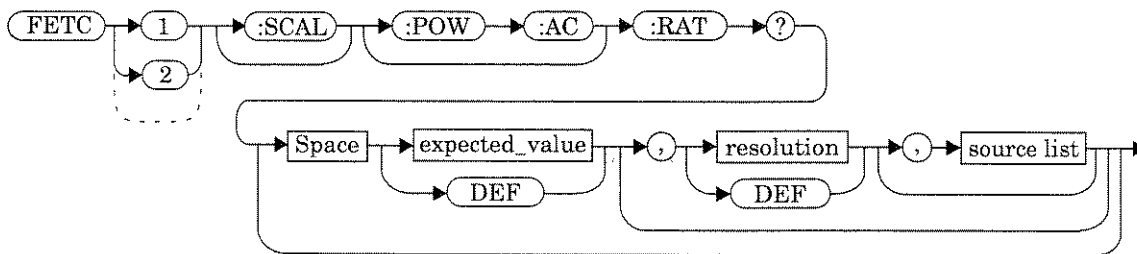

Parameters

Refer to “The Optional Parameters”, on page 2-3 for additional details on the parameters in this command.

Item	Description/Default	Range of Values
expected_value (for the expected power level)	The power meter ignores the numeric value entered in this parameter. Any value entered is treated like DEF.	sensor dependent DEF ¹
resolution	A numeric value for the resolution. If it is unspecified the current resolution setting is used. If a value is entered it should correspond to the current resolution setting otherwise an error occurs.	1 to 4 ² 1.0, 0.1, 0.01, 0.001 DEF ¹

MEASurement Instructions

FETCh[1|2][:SCALAr][:POWER:AC]:RATio? [<expected_value>,<resolution>,<source list>]]

Item	Description/Default	Range of Values
source list	This channel list specifies between which channels the ratio is calculated. If unspecified and the current window setup is a ratio measurement then this ratio setup is used, otherwise it defaults to channel A/B.	(@1),(@2) (@2),(@1)

1. The mnemonic DEF means DEFault. This is not equivalent to the DEFault parameter used in the command sub-systems. The parameters must be entered in the specified order. If parameters are omitted, they will default from the right. The parameter DEFault is used as a place holder. Specifying DEF leaves the parameter value unchanged.
2. When the measurement result is linear this parameter represents the number of significant digits. When the measurement result is logarithmic 1 to 4 represents a resolution of 1, 0.1, 0.01 and 0.001 respectively.

Example

FETC2 :RAT? DEF , 1 , (@1) , (@2)

This command queries the lower window's ratio measurement of channel A over channel B, using the current sensor range and a resolution of 1 on both channels.

Error Messages

If the last measurement on either channel is not valid error -230, "Data corrupt or stale" occurs. A measurement is valid after it has been initiated. It becomes invalid when either a reset occurs or any measurement parameter, for example frequency, is changed.

If the resolution parameter is not the same as the current resolution setting on the specified window, error -221, "Settings conflict" occurs.

FETCh[1|2][:SCALar][:POWer:AC]:RATio:RELative? [<expected_value>[,<resolution>[,<source list>]]]

FETCh[1|2][:SCALar][:POWer:AC]:RATio:RELative?
 [<expected_value>[,<resolution>[,<source list>]]]

This command is only relevant for the HP EPM-442A power meter.

This command sets the specified window's measurement function to power ratio with relative mode on, recalculates the measurement and places the results on the bus. The result is a ratio based measurement and is expressed in the units defined by UNIT[1|2]:POWER:RATio. The relative value used is that set by the CALCulate:RELative:MAGNitude:AUTO command.

Syntax

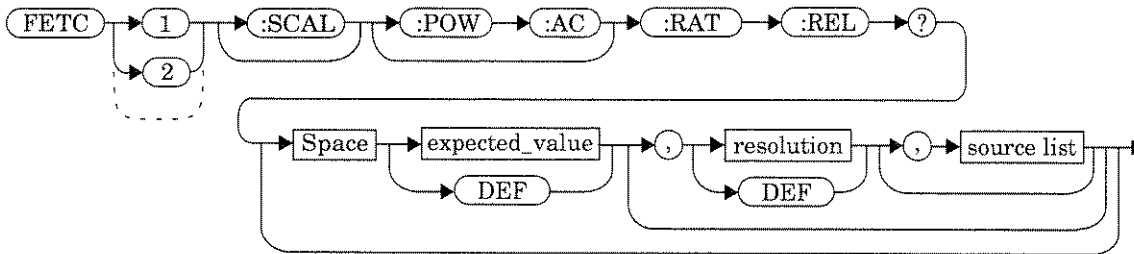

Parameters

Refer to “The Optional Parameters”, on page 2-3 for additional details on the parameters in this command.

Item	Description/Default	Range of Values
expected_value (for the expected power level)	The power meter ignores the numeric value entered in this parameter. Any value entered is treated like DEF.	sensor dependent DEF ¹
resolution	A numeric value for the resolution. If it is unspecified the current resolution setting is used. If a value is entered it should correspond to the current resolution setting otherwise an error occurs.	1 to 4 ² 1.0, 0.1, 0.01, 0.001 DEF ¹

MEASurement Instructions

FETCh[1|2][:SCALar][:POWER:AC]:RATio:RELative? [<expected_value>,<resolution>,<source list>]]

Item	Description/Default	Range of Values
source list	This channel list specifies between which channels the ratio is calculated. If unspecified and the current window setup is a ratio measurement then this ratio setup is used, otherwise it defaults to channel A/B.	(@1),(@2) (@2),(@1)

1. The mnemonic DEF means DEFault. This is not equivalent to the DEFault parameter used in the command sub-systems. The parameters must be entered in the specified order. If parameters are omitted, they will default from the right. The parameter DEFault is used as a place holder. Specifying DEF leaves the parameter value unchanged.
2. When the measurement result is linear this parameter represents the number of significant digits. When the measurement result is logarithmic 1 to 4 represents a resolution of 1, 0.1, 0.01 and 0.001 respectively.

Example

FETC:RAT:REL?

This command queries the relative ratio measurement on the upper window.

Error Messages

If the last measurement on either channel is not valid error -230, "Data corrupt or stale" occurs. A measurement is valid after it has been initiated. It becomes invalid when either a reset occurs or any measurement parameter, for example frequency, is changed.

If the resolution parameter is not the same as the current resolution setting on the specified window, error -221, "Settings conflict" occurs.

READ[1|2] Commands

The READ? commands are most commonly used with the CONFigure command to cause a new power measurement to be taken and the result returned to the output buffer. The format of the return is <NR3>, for example, -6.98970004E-001.

- For the HP EPM-441A the READ? query is equivalent to:
ABORt
INITiate
FETCh?
- For the HP EPM-442A carrying out a single channel measurement the READ? queries are equivalent to:
ABORt1
INITiate1
FETCh1?

or
ABORt2
INITiate2
FETCh2?
- For the HP EPM-442A carrying out a difference measurement the READ:DIFFerence? queries are equivalent to:
ABORt1and
ABORt2
INITiate1
INITiate2
FETCh:DIFFerence?
- For the HP EPM-442A carrying out a ratio measurement the READ:RATio? queries are equivalent to:
ABORt1
ABORt2
INITiate1
INITiate2
FETCh:RATio?

READ[1|2][:SCALar][:POWer:AC]? [<expected_value>[,<resolution>[,<source list>]]]

READ[1|2][:SCALar][:POWer:AC]? [<expected_value>[,<resolution>[,<source list>]]]

This command sets the specified window's measurement function to single channel with relative mode off, aborts then initiates the specified channel, calculates the measurement result and places the result on the bus. The result is a power based measurement and is expressed in the units defined by `UNIT[1|2]:POWer`.

Note

`INITiate:CONTInuous` must be set to OFF, otherwise error -213, "INIT ignored" occurs. If `TRIGger:SOURce` is set to BUS, error -214, "Trigger deadlock" occurs.

Syntax

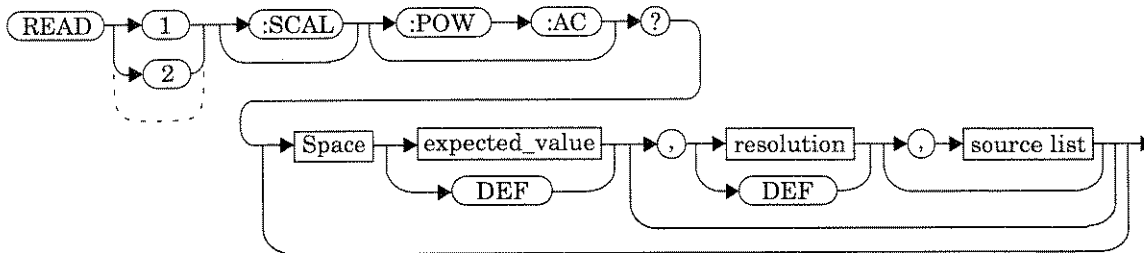

Parameters

Refer to "The Optional Parameters", on page 2-3 for additional details on the parameters in this command.

Item	Description/Default	Range of Values
expected_value (for the expected power level)	The expected power level parameter can be set to DEF or a numeric value. If a value is entered it should correspond to that set by <code>CONFigure</code> otherwise an error occurs.	sensor dependent DEF ¹

READ[1|2][[:SCALar]][:POWer:AC]? [<expected_value>[,<resolution>[,<source list>]]]

Item	Description/Default	Range of Values
resolution	A numeric value for the resolution. If it is unspecified the current resolution setting is used. If a value is entered it should correspond to the current resolution setting otherwise an error occurs.	1 to 4 ² 1.0, 0.1, 0.01, 0.001 DEF ¹
source list	This is the channel on which the command is implemented. If unspecified the current window setup is used. However, on the HP EPM-442A, if the window shows a ratio or difference measurement, the upper window defaults to channel A and the lower window to channel B.	(@1) (@2) (HP EPM-442A only)

1. The mnemonic DEF means DEFault. This is not equivalent to the DEFault parameter used in the command sub-systems. The parameters must be entered in the specified order. If parameters are omitted, they will default from the right. The parameter DEFault is used as a place holder. Specifying DEF leaves the parameter value unchanged.

2. When the measurement result is linear this parameter represents the number of significant digits. When the measurement result is logarithmic 1 to 4 represents a resolution of 1, 0.1, 0.01 and 0.001 respectively.

Example

READ2:POW:AC?

This command queries the lower window's measurement.

Error Messages

INITiate:CONTinuous must be set to OFF, otherwise error -213, "INIT ignored" occurs.

If TRIGger:SOURce is set to BUS or HOLD, error -214, "Trigger deadlock" occurs.

If the expected value and resolution parameters are not the same as the current expected value and resolution settings on the specified window, error -221, "Settings conflict" occurs.

MEASurement Instructions

READ[1|2][:SCALar][:POWer:AC]:RELative? [<expected_value>[,<resolution>[,<source list>]]]

READ[1|2][:SCALar][:POWer:AC]:RELative?
[<expected_value>[,<resolution>[,<source list>]]]

This command sets the specified window's measurement function to single channel with relative mode on, aborts then initiates the specified channel, calculates the measurement result and places the result on the bus. The result is a ratio based measurement and is expressed in the units defined by **UNIT[1|2]:POWER:RATio**. The relative value used is that set by the **CALCulate:RELative:MAGNitude:AUTO** command.

Note **INITiate:CONTinuous** must be set to OFF, otherwise error -213, "INIT ignored" occurs. If **TRIGger:SOURce** is set to BUS, error -214, "Trigger deadlock" occurs.

Syntax

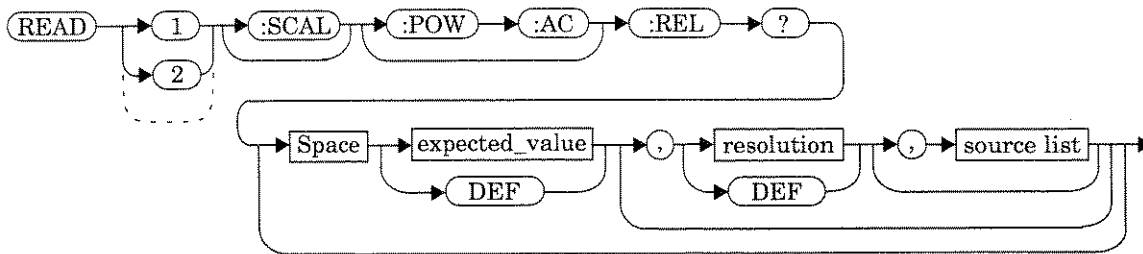

Parameters

Refer to "The Optional Parameters", on page 2-3 for additional details on the parameters in this command.

Item	Description/Default	Range of Values
expected_value (for the expected power level)	The expected power level parameter can be set to DEF or a numeric value. If a value is entered it should correspond to that set by CONFigure otherwise an error occurs.	sensor dependent DEF ¹

READ[1|2][[:SCALar][:POWER:AC]:RELative? [<expected_value>[,<resolution>[,<source list>]]]

Item	Description/Default	Range of Values
resolution	A numeric value for the resolution. If it is unspecified the current resolution setting is used. If a value is entered it should correspond to the current resolution setting otherwise an error occurs.	1 to 4 ² 1.0, 0.1, 0.01, 0.001 DEF ¹
source list	This is the channel on which the command is implemented. If unspecified the current window setup is used. However, on the HP EPM-442A, if the window shows a ratio or difference measurement, the upper window defaults to channel A and the lower window to channel B.	(@1) (@2) (HP EPM-442A only)

1. The mnemonic DEF means DEFault. This is not equivalent to the DEFault parameter used in the command sub-systems. The parameters must be entered in the specified order. If parameters are omitted, they will default from the right. The parameter DEFault is used as a place holder. Specifying DEF leaves the parameter value unchanged.

2. When the measurement result is linear this parameter represents the number of significant digits. When the measurement result is logarithmic 1 to 4 represents a resolution of 1, 0.1, 0.01 and 0.001 respectively.

Example

```
READ1:REL? DEF,1,(@2)
```

This command queries the upper window's relative measurement of channel B, using the current sensor range and a resolution of 1.

MEASurement Instructions

READ[1|2][:SCALAR][:POWER:AC]:RELative? [<expected_value>[,<resolution>[,<source list>]]]

Error Messages

INITiate:CONTinuous must be set to OFF, otherwise error -213, "INIT ignored" occurs.

If TRIGger:SOURce is set to BUS or HOLD, error -214, "Trigger deadlock" occurs.

If the expected value and resolution parameters are not the same as the current expected value and resolution settings on the specified window, error -221, "Settings conflict" occurs.

READ[1|2][:SCALar][:POWer:AC]:DIFFerence? [<expected_value>[,<resolution>[,<source list>]]]

READ[1|2][:SCALar][:POWer:AC]:DIFFerence?
 [<expected_value>[,<resolution>[,<source list>]]]

This command is only relevant for the HP EPM-442A power meter.

This command sets the specified window's measurement function to difference mode with relative mode off, aborts then initiates both channel A and B, calculates the difference measurement result and places the result on the bus. The result is a power based measurement and is expressed in the units defined by UNIT[1|2]:POWER.

Note INITiate:CONTinuous must be set to OFF on both channels, otherwise error -213, "INIT ignored" occurs. If TRIGger:SOURce is set to BUS on either channel, error -214, "Trigger deadlock" occurs.

Syntax

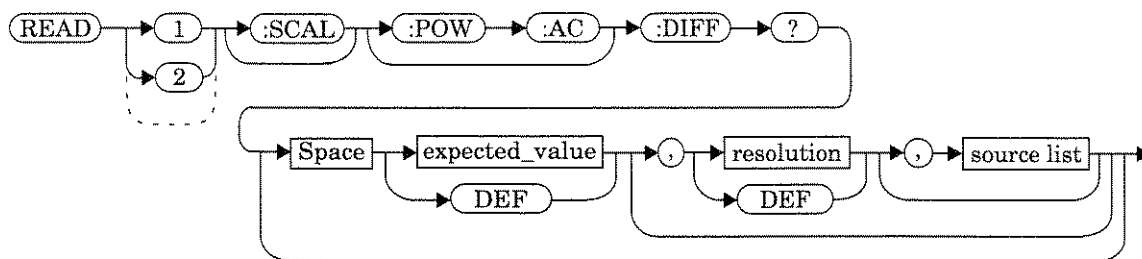

Parameters

Refer to "The Optional Parameters", on page 2-3 for additional details on the parameters in this command.

Item	Description/Default	Range of Values
expected_value (for the expected power level)	The power meter ignores the numeric value entered in this parameter. Any value entered is treated like DEF.	sensor dependent DEF ¹

MEASurement Instructions

READ[1|2][[:SCALAr][:POWer:AC]:DIFFerence? [<expected_value>[,<resolution>[,<source list>]]]

Item	Description/Default	Range of Values
resolution	A numeric value for the resolution. If it is unspecified the current resolution setting is used. If a value is entered it should correspond to the current resolution setting otherwise an error occurs.	1 to 4 ² 1.0, 0.1, 0.01, 0.001 DEF ¹
source list	This channel list specifies between which channels the difference is calculated. If unspecified and the current window setup is a difference measurement then this difference setup is used, otherwise it defaults to channel A-B.	(@1),(@2) (@2),(@1)

1. The mnemonic DEF means DEFault. This is not equivalent to the DEFault parameter used in the command sub-systems. The parameters must be entered in the specified order. If parameters are omitted, they will default from the right. The parameter DEFault is used as a place holder. Specifying DEF leaves the parameter value unchanged.

2. When the measurement result is linear this parameter represents the number of significant digits. When the measurement result is logarithmic 1 to 4 represents a resolution of 1, 0.1, 0.01 and 0.001 respectively.

Example

READ2 : DIFF?

This command queries difference measurement on the lower window.

Error Messages

INITiate:CONTInuous must be set to OFF on both channels, otherwise error -213, "INIT ignored" occurs.

If TRIGger:SOURCE is set to BUS or HOLD on either channel, error -214, "Trigger deadlock" occurs.

If the resolution parameter is not the same as the current resolution setting on the specified window, error -221, "Settings conflict" occurs.

READ[1|2][:SCALar][:POWer:AC]:DIFFerence:RELative? [<expected_value>[,<resolution>[,<source list>]]]

READ[1|2][:SCALar][:POWer:AC]:DIFFerence:RELative? [<expected_value>[,<resolution>[,<source list>]]]

This command is only relevant for the HP EPM-442A power meter.

This command sets the specified window's measurement function to difference mode with relative mode on, aborts then initiates both channel A and B, calculates the difference measurement result and places the result on the bus. The result is a ratio based measurement and is expressed in the units defined by `UNIT[1|2]:POWER:RATio`. The relative value used is that set by the `CALCulate:RELative:MAGNitude:AUTO` command.

Note `INITiate:CONTinuous` must be set to OFF on both channels, otherwise error -213, "INIT ignored" occurs. If `TRIGger:SOURce` is set to BUS on either channel, error -214, "Trigger deadlock" occurs.

Syntax

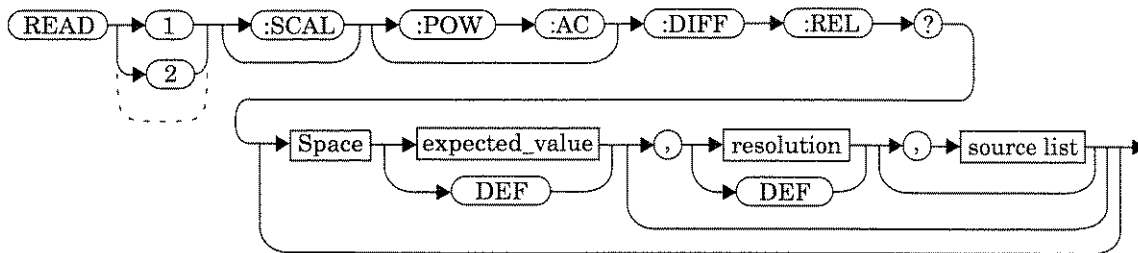

Parameters

Refer to "The Optional Parameters", on page 2-3 for additional details on the parameters in this command.

Item	Description/Default	Range of Values
expected_value (for the expected power level)	The power meter ignores the numeric value entered in this parameter. Any value entered is treated like DEF.	sensor dependent DEF ¹

MEASurement Instructions

READ[1|2][[:SCALAr][[:POWER:AC]:DIFFerence:RELative? [<expected_value>[,<resolution>[,<source list>]]]

Item	Description/Default	Range of Values
resolution	A numeric value for the resolution. If it is unspecified the current resolution setting is used. If a value is entered it should correspond to the current resolution setting otherwise an error occurs.	1 to 4 ² 1.0, 0.1, 0.01, 0.001 DEF ¹
source list	This channel list specifies between which channels the difference is calculated. If unspecified and the current window setup is a difference measurement then this difference setup is used, otherwise it defaults to channel A-B.	(@1),(@2) (@2),(@1)

1. The mnemonic DEF means DEFault. This is not equivalent to the DEFault parameter used in the command sub-systems. The parameters must be entered in the specified order. If parameters are omitted, they will default from the right. The parameter DEFault is used as a place holder. Specifying DEF leaves the parameter value unchanged.

2. When the measurement result is linear this parameter represents the number of significant digits. When the measurement result is logarithmic 1 to 4 represents a resolution of 1, 0.1, 0.01 and 0.001 respectively.

Example

`READ1:DIFF:REL? DEF,4,(@2),(@1)` *This command queries the upper window's relative difference measurement of channel B - channel A, using the current sensor range and a resolution setting of 4 on both channels.*

Error Messages

INITiate:CONTinuous must be set to OFF on both channels, otherwise error -213, "INIT ignored" occurs.

If TRIGger:SOURce is set to BUS or HOLD on either channel, error -214, "Trigger deadlock" occurs.

If the resolution parameter is not the same as the current resolution setting on the specified window, error -221, "Settings conflict" occurs.

READ[1|2][:SCALar][:POWer:AC]:RATio? [<expected_value>[,<resolution>[,<source list>]]]

READ[1|2][:SCALar][:POWer:AC]:RATio? [<expected_value>[,<resolution>[,<source list>]]]

This command is only relevant for the HP EPM-442A power meter.

This command sets the specified window's measurement function to ratio mode with relative mode off, aborts then initiates both channel A and B, calculates the ratio measurement result and places the result on the bus. The result is a ratio based measurement and is expressed in the units defined by `UNIT[1|2]:POWer:RATio`.

Note

`INITiate:CONTinuous` must be set to OFF on both channels, otherwise error -213, "INIT ignored" occurs. If `TRIGger:SOURce` is set to BUS on either channel, error -214, "Trigger deadlock" occurs.

Syntax

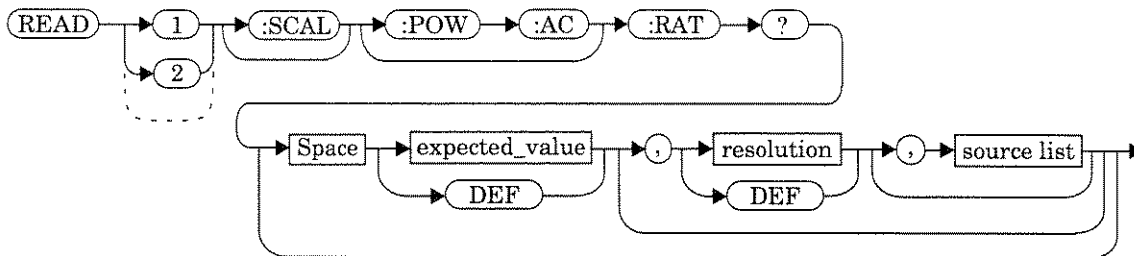

Parameters

Refer to "The Optional Parameters", on page 2-3 for additional details on the parameters in this command.

Item	Description/Default	Range of Values
expected_value (for the expected power level)	The power meter ignores the numeric value entered in this parameter. Any value entered is treated like DEF.	sensor dependent DEF ¹

READ[1|2][:SCALar][:POWer:AC]:RATio? [<expected_value>,<resolution>,<source list>]]

Item	Description/Default	Range of Values
resolution	A numeric value for the resolution. If it is unspecified the current resolution setting is used. If a value is entered it should correspond to the current resolution setting otherwise an error occurs.	1 to 4 ² 1.0, 0.1, 0.01, 0.001 DEF ¹
source list	This channel list specifies between which channels the ratio is calculated. If unspecified and the current window setup is a ratio measurement then this ratio setup is used, otherwise it defaults to channel A/B.	(@1),(@2) (@2),(@1)

1. The mnemonic DEF means DEFault. This is not equivalent to the DEFault parameter used in the command sub-systems. The parameters must be entered in the specified order. If parameters are omitted, they will default from the right. The parameter DEFault is used as a place holder. Specifying DEF leaves the parameter value unchanged.
2. When the measurement result is linear this parameter represents the number of significant digits. When the measurement result is logarithmic 1 to 4 represents a resolution of 1, 0.1, 0.01 and 0.001 respectively.

Example

READ2:RAT? DEF,1,(@1),(@2) *This command queries the lower window's ratio measurement of channel A over channel B, using the current sensor range and a resolution of 1 on both channels.*

Error Messages

INITiate:CONTinuous must be set to OFF on both channels, otherwise error -213, "INIT ignored" occurs.

If TRIGger:SOURce is set to BUS or HOLD on either channel, error -214, "Trigger deadlock" occurs.

If the resolution parameter is not the same as the current resolution setting on the specified window, error -221, "Settings conflict" occurs.

READ[1|2][:SCALar][:POWER:AC]:RATio:RELative? [<expected_value>[,<resolution>[,<source list>]]]

**READ[1|2][:SCALar][:POWER:AC]:RATio:RELative?
[<expected_value>[,<resolution>[,<source list>]]]**

This command is only relevant for the HP EPM-442A power meter.

This command sets the specified window's measurement function to ratio mode with relative mode on, aborts then initiates both channel A and B, calculates the ratio measurement result using the new sensor data and places the result on the bus. The result is a ratio based measurement and is expressed in the units defined by `UNIT[1|2]:POWER:RATio`. The relative value used is that set by the `CALCulate:RELative:MAGNitude:AUTO` command.

Note

`INITiate:CONTinuous` must be set to `OFF` on both channels, otherwise error -213, "INIT ignored" occurs. If `TRIGger:SOURce` is set to `BUS` on either channel, error -214, "Trigger deadlock" occurs.

Syntax

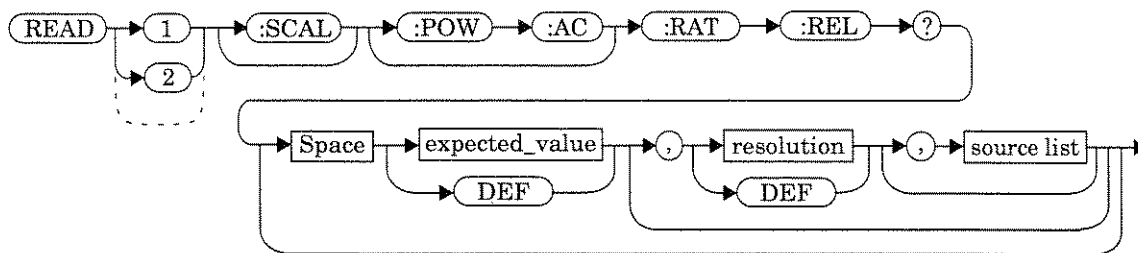

Parameters

Refer to "The Optional Parameters", on page 2-3 for additional details on the parameters in this command.

Item	Description/Default	Range of Values
expected_value (for the expected power level)	The power meter ignores the numeric value entered in this parameter. Any value entered is treated like DEF.	sensor dependent DEF ¹

READ[112][:SCALar][:POWer:AC]:RATio:RELative? [<expected_value>[,<resolution>[,<source list>]]]

Item	Description/Default	Range of Values
resolution	A numeric value for the resolution. If it is unspecified the current resolution setting is used. If a value is entered it should correspond to the current resolution setting otherwise an error occurs.	1 to 4 ² 1.0, 0.1, 0.01, 0.001 DEF ¹
source list	This channel list specifies between which channels the ratio is calculated. If unspecified and the current window setup is a ratio measurement then this ratio setup is used, otherwise it defaults to channel A/B.	(@1),(@2) (@2),(@1)

1. The mnemonic DEF means DEFault. This is not equivalent to the DEFault parameter used in the command sub-systems. The parameters must be entered in the specified order. If parameters are omitted, they will default from the right. The parameter DEFault is used as a place holder. Specifying DEF leaves the parameter value unchanged.
2. When the measurement result is linear this parameter represents the number of significant digits. When the measurement result is logarithmic 1 to 4 represents a resolution of 1, 0.1, 0.01 and 0.001 respectively.

Example

READ:RAT:REL? *This command queries the relative ratio measurement on the upper window.*

Error Messages

INITiate:CONTinuous must be set to OFF on both channels, otherwise error -213, "INIT ignored" occurs.

If TRIGger:SOURce is set to BUS or HOLD on either channel, error -214, "Trigger deadlock" occurs.

If the resolution parameter is not the same as the current resolution setting on the specified window, error -221, "Settings conflict" occurs.

MEASure[1|2] Commands

The MEASure? commands configure the power meter to perform a power measurement with the given measurement function, relative mode setting, range and resolution then makes the measurement. The format of the return is <NR3>, for example, -6.98970004E-001. MEASure? is a compound command which is equivalent to:

- For the HP EPM-441A the MEASure? query is equivalent to:
ABORT
CONFigure
READ?
- For the HP EPM-442A carrying out a single channel measurement the MEASure? queries are equivalent to:
ABORT1
CONFigure
READ1?

or
ABORT2
CONFigure
READ2?
- For the HP EPM-442A carrying out a difference measurement the READ:DIFFerence? queries are equivalent to:
ABORT1
ABORT2
CONFigure:DIFFerence
READ:DIFFerence?
- For the HP EPM-442A carrying out a ratio measurement the READ:RATio? queries are equivalent to:
ABORT1
ABORT2
CONFigure:RATio
READ:RATio?

MEASurement Instructions

MEASure[1|2][:SCALar][:POWer:AC]? [<expected_value>,<resolution>,<source list>]]

MEASure[1|2][:SCALar][:POWer:AC]? [<expected_value>,<resolution>,<source list>]]

This command sets the specified window's measurement function to single channel with relative mode off, aborts, configures the window then initiates channel A or B, calculates the measurement result and places the result on the bus.

Syntax

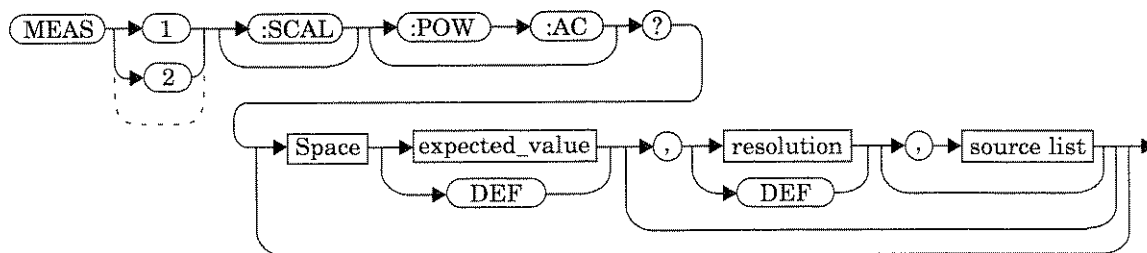

Parameters

Refer to “The Optional Parameters”, on page 2-3 for additional details on the parameters in this command.

Item	Description/Default	Range of Values
expected_value (for the expected power level)	A numeric value for the expected power level. The units of measurement are dBm and W. The default units are defined by UNIT:POWer.	sensor dependent DEF ¹
resolution	A numeric value for the resolution. If unspecified the current resolution setting is used.	1 to 4 ² 1.0, 0.1, 0.01, 0.001 DEF ¹

MEASure[1|2][:SCALar][:POWer:AC]? [<expected_value>,<resolution>,<source list>]]

Item	Description/Default	Range of Values
source list	This is the channel on which the command is implemented. If unspecified the current window setup is used. However, on the HP EPM-442A, if the window shows a ratio or difference measurement, the upper window defaults to channel A and the lower window to channel B.	(@1) (@2) (HP EPM-442A only)

1. The mnemonic DEF means DEFault. This is not equivalent to the DEFault parameter used in the command sub-systems. The parameters must be entered in the specified order. If parameters are omitted, they will default from the right. The parameter DEFault is used as a place holder. Specifying DEF leaves the parameter value unchanged.

2. When the measurement result is linear this parameter represents the number of significant digits. When the measurement result is logarithmic 1 to 4 represents a resolution of 1, 0.1, 0.01 and 0.001 respectively.

Example

MEAS2:POW:AC? -70DBM,1,(@1) *This command queries the lower window's measurement of channel A, using an expected power level of -70 dBm and a resolution setting of 1.*

MEASure[1|2][:SCALar][:POWer:AC]:RELative? [<expected_value>,<resolution>,<source list>]]

MEASure[1|2][:SCALar][:POWer:AC]:RELative? [<expected_value>,<resolution>,<source list>]]

This command sets the specified window's measurement function to single channel with relative mode on, aborts, configures then initiates the specified channel, calculates the measurement result and places the result on the bus. The result is a ratio based measurement and is expressed in the units defined by UNIT[1|2]:POWer:RATio. The relative value used is that set by the CALCulate:RELative:MAGNitude:AUTO command.

Syntax

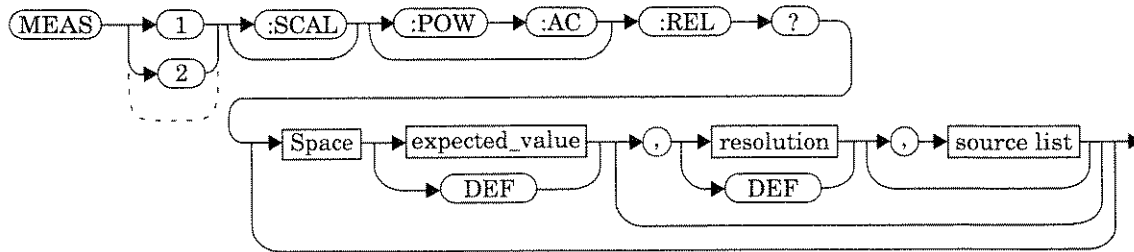

Parameters

Refer to “The Optional Parameters”, on page 2-3 for additional details on the parameters in this command.

Item	Description/Default	Range of Values
expected_value (for the expected power level)	A numeric value for the expected power level. The units of measurement are dBm and W. The default units are defined by UNIT:POWer.	sensor dependent DEF ¹
resolution	A numeric value for the resolution. If unspecified the current resolution setting is used.	1 to 4 ² 1.0, 0.1, 0.01, 0.001 DEF ¹

MEASure[1|2][:SCALar][:POWer:AC]:RELative? [<expected_value>[,<resolution>[,<source list>]]]

Item	Description/Default	Range of Values
source list	This is the channel on which the command is implemented. If unspecified the current window setup is used. However, on the HP EPM-442A, if the window shows a ratio or difference measurement, the upper window defaults to channel A and the lower window to channel B.	(@1) (@2) (HP EPM-442A only)

1. The mnemonic DEF means DEFault. This is not equivalent to the DEFault parameter used in the command sub-systems. The parameters must be entered in the specified order. If parameters are omitted, they will default from the right. The parameter DEFault is used as a place holder. Specifying DEF leaves the parameter value unchanged.
2. When the measurement result is linear this parameter represents the number of significant digits. When the measurement result is logarithmic 1 to 4 represents a resolution of 1, 0.1, 0.01 and 0.001 respectively.

Example

MEAS1:REL? -50DBM, 2, (@2)

This command queries the upper window's relative measurement of channel B, using an expected power level of -50 dBm and a resolution setting of 2.

MEASure[1|2][:SCALar][:POWER:AC]:DIFFerence? [<expected_value>,<resolution>,<source list>]]

MEASure[1|2][:SCALar][:POWER:AC]:DIFFerence?
 [<expected_value>,<resolution>,<source list>]]

This command is only relevant for the HP EPM-442A power meter.

This command sets the specified window's measurement function to difference mode with relative mode off, aborts, configures then initiates both channel A and B, calculates the difference measurement result and places the result on the bus. The result is a power based measurement and is expressed in the units defined by UNIT[1|2]:POWER.

Syntax

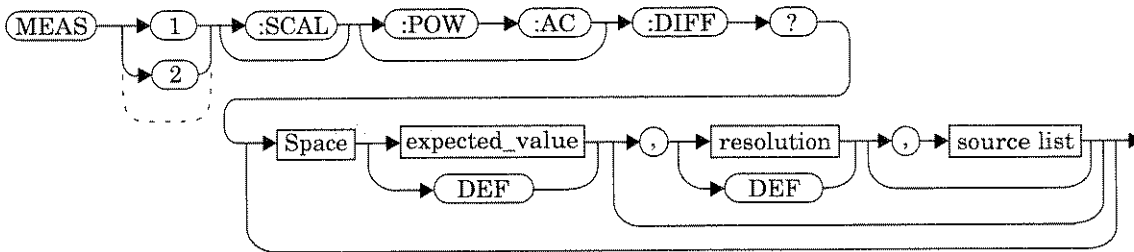

Parameters

Refer to “The Optional Parameters”, on page 2-3 for additional details on the parameters in this command.

Item	Description/Default	Range of Values
expected_value (for the expected power level)	The power meter ignores the numeric value entered in this parameter. Any value entered is treated like DEF.	sensor dependent DEF ¹
resolution	A numeric value for the resolution. If unspecified the current resolution setting is used.	1 to 4 ² 1.0, 0.1, 0.01, 0.001 DEF ¹

MEASure[1|2][[:SCALar][[:POWER:AC]:DIFFerence? [<expected_value>[,<resolution>[,<source list>]]]

Item	Description/Default	Range of Values
source list	This channel list specifies between which channels the difference is calculated. If unspecified and the current window setup is a difference measurement then this difference setup is used, otherwise it defaults to channel A-B.	(@1),(@2) (@2),(@1)

1. The mnemonic DEF means DEFault. This is not equivalent to the DEFault parameter used in the command sub-systems. The parameters must be entered in the specified order. If parameters are omitted, they will default from the right. The parameter DEFault is used as a place holder. Specifying DEF leaves the parameter value unchanged.

2. When the measurement result is linear this parameter represents the number of significant digits. When the measurement result is logarithmic 1 to 4 represents a resolution of 1, 0.1, 0.01 and 0.001 respectively.

Example

MEAS2:DIFF?

This command queries the difference measurement on the lower window.

MEASurement Instructions

MEASure[1|2][:SCALar][:POWer:AC]:DIFFerence:RELative?
 [<expected_value>[,<resolution>[,<source list>]]]

MEASure[1|2][:SCALar][:POWer:AC]:DIFFerence:RELative?
 [<expected_value>[,<resolution>[,<source list>]]]

This command is only relevant for the HP EPM-442A power meter.

This command sets the specified window's measurement function to difference mode with relative mode on, aborts, configures then initiates both channel A and B, calculates the difference measurement result and places the result on the bus. The result is a ratio based measurement and is expressed in the units defined by UNIT[1|2]:POWER:RATio. The relative value used is that set by the CALCulate:RELative:MAGNitude:AUTO command.

Syntax

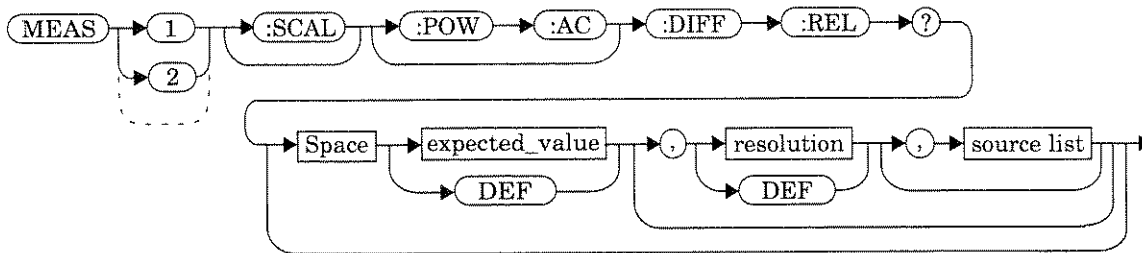

Parameters

Refer to “The Optional Parameters”, on page 2-3 for additional details on the parameters in this command.

Item	Description/Default	Range of Values
expected_value (for the expected power level)	The power meter ignores the numeric value entered in this parameter. Any value entered is treated like DEF.	sensor dependent DEF ¹
resolution	A numeric value for the resolution. If unspecified the current resolution setting is used.	1 to 4 ² 1.0, 0.1, 0.01, 0.001 DEF ¹

MEASurement Instructions
MEASure[1|2]:SCALar[:POWER:AC]:DIFFerence:RELative?
 [<expected_value>,<resolution>,<source list>]]

Item	Description/Default	Range of Values
source list	This channel list specifies between which channels the difference is calculated. If unspecified and the current window setup is a difference measurement then this difference setup is used, otherwise it defaults to channel A-B.	(@1),(@2) (@2),(@1)

1. The mnemonic DEF means DEFault. This is not equivalent to the DEFault parameter used in the command sub-systems. The parameters must be entered in the specified order. If parameters are omitted, they will default from the right. The parameter DEFault is used as a place holder. Specifying DEF leaves the parameter value unchanged.

2. When the measurement result is linear this parameter represents the number of significant digits. When the measurement result is logarithmic 1 to 4 represents a resolution of 1, 0.1, 0.01 and 0.001 respectively.

Example

```
MEAS1:DIFF:REL? DEF,3,(@2),(@1)
```

This command queries the upper window's relative difference measurement of channel B - channel A, using the current sensor range and a resolution setting of 3 on both channels.

MEASure[1|2][:SCALar][:POWer:AC]:RATio? [<expected_value>[,<resolution>[,<source list>]]]

MEASure[1|2][:SCALar][:POWer:AC]:RATio?

[<expected_value>[,<resolution>[,<source list>]]]

This command is only relevant for the HP EPM-442A power meter.

This command sets the specified window's measurement function to ratio mode with relative mode off, aborts, configures then initiates both channel A and B, calculates the ratio measurement result and places the result on the bus. The result is a ratio based measurement and is expressed in the units defined by UNIT[1|2]:POWER:RATio.

Syntax

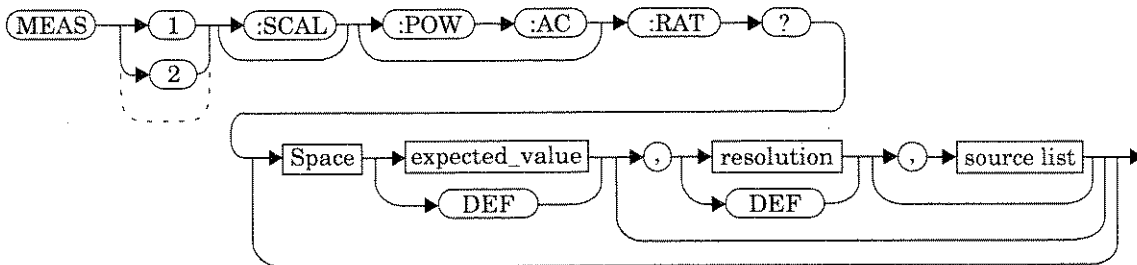

Parameters

Refer to “The Optional Parameters”, on page 2-3 for additional details on the parameters in this command.

Item	Description/Default	Range of Values
expected_value (for the expected power level)	The power meter ignores the numeric value entered in this parameter. Any value entered is treated like DEF.	sensor dependent DEF ¹
resolution	A numeric value for the resolution. If unspecified the current resolution setting is used.	1 to 4 ² 1.0, 0.1, 0.01, 0.001 DEF ¹

MEASure[1|2][:SCALar][:POWER:AC]:RATio? [<expected_value>[,<resolution>[,<source list>]]]

Item	Description/Default	Range of Values
source list	This channel list specifies between which channels the ratio is calculated. If unspecified and the current window setup is a ratio measurement then this ratio setup is used, otherwise it defaults to channel A/B.	(@1),(@2) (@2),(@1)

1. The mnemonic DEF means DEFault. This is not equivalent to the DEFault parameter used in the command sub-systems. The parameters must be entered in the specified order. If parameters are omitted, they will default from the right. The parameter DEFault is used as a place holder. Specifying DEF leaves the parameter value unchanged.

2. When the measurement result is linear this parameter represents the number of significant digits. When the measurement result is logarithmic 1 to 4 represents a resolution of 1, 0.1, 0.01 and 0.001 respectively.

Example

```
MEAS2:RAT? DEF,1,(@1),(@2)
```

This command queries the lower window's ratio measurement of channel A over channel B, using the current sensor range and a resolution of 1 on both channels.

MEASurement Instructions

MEASure[1|2][:SCALar][:POWer:AC]:RATio:RELative? [<expected_value>,<resolution>,<source list>]]

MEASure[1|2][:SCALar][:POWer:AC]:RATio:RELative?
 [<expected_value>,<resolution>,<source list>]]

This command is only relevant for the HP EPM-442A power meter.

This command sets the specified window's measurement function to ratio mode with relative mode on, aborts, configures then initiates both channel A and B, calculates the ratio measurement and places the result on the bus. The result is a ratio based measurement and is expressed in the units defined by UNIT[1|2]:POWER:RATIO. The relative value used is that set by the CALCulate:RELative:MAGNitude:AUTO command.

Syntax

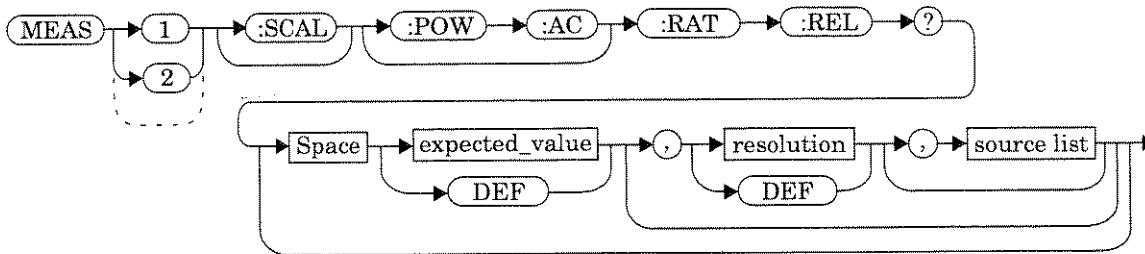

Parameters

Refer to “The Optional Parameters”, on page 2-3 for additional details on the parameters in this command.

Item	Description/Default	Range of Values
expected_value (for the expected power level)	The power meter ignores the numeric value entered in this parameter. Any value entered is treated like DEF.	sensor dependent DEF ¹
resolution	A numeric value for the resolution. If unspecified the current resolution setting is used.	1 to 4 ² 1.0, 0.1, 0.01, 0.001 DEF ¹

MEASure[1|2][[:SCALar][[:POWER:AC]:RATio:RELative? [<expected_value>[,<resolution>[,<source list>]]]

Item	Description/Default	Range of Values
source list	This channel list specifies between which channels the ratio is calculated. If unspecified and the current window setup is a ratio measurement then this ratio setup is used, otherwise it defaults to channel A/B.	(@ 1),(@ 2) (@ 2),(@ 1)

1. The mnemonic DEF means DEFault. This is not equivalent to the DEFault parameter used in the command sub-systems. The parameters must be entered in the specified order. If parameters are omitted, they will default from the right. The parameter DEFault is used as a place holder. Specifying DEF leaves the parameter value unchanged.

2. When the measurement result is linear this parameter represents the number of significant digits. When the measurement result is logarithmic 1 to 4 represents a resolution of 1, 0.1, 0.01 and 0.001 respectively.

Example

MEAS : RAT : REL ?

This command queries the relative ratio measurement on the upper window.

MEASurement Instructions

MEASure[1|2][:SCALar][:POWER:AC]:RATio:RELative? [<expected_value>,<resolution>,<source list>]]

3

CALCulate Subsystem

CALCulate Subsystem

The CALCulate subsystem exists to perform post acquisition data processing. Functions in the SENSE subsystem are related to data acquisition, while the CALCulate subsystem operates on the data acquired by a SENSE function.

The numeric suffix of the CALCulate program mnemonic in the CALCulate commands refers to a window, that is CALCulate1 and CALCulate2 represent the upper and lower windows respectively.

In the power meter there are two independent CALCulate blocks, one for each window. Data from both SENSE blocks may feed either or both CALCulate blocks via the MATH command. Figure 3-1 details where the commands are applied within the CALCulate block.

Keyword	Parameter Form	Notes	Page
CALCulate[1 2]			
:GAIN			
[:MAGNitude]	<numeric_value>		page 3-4
:STATe	<Boolean>		page 3-6
:MATH			
[:EXPRession]	<string>		page 3-8
:CATalog?		[query only]	page 3-10
:RELative			
[:MAGNitude]			
:AUTO	<Boolean> ONCE		page 3-12
:STATe	<Boolean>		page 3-14

Figure 3-1: CALCulate Block

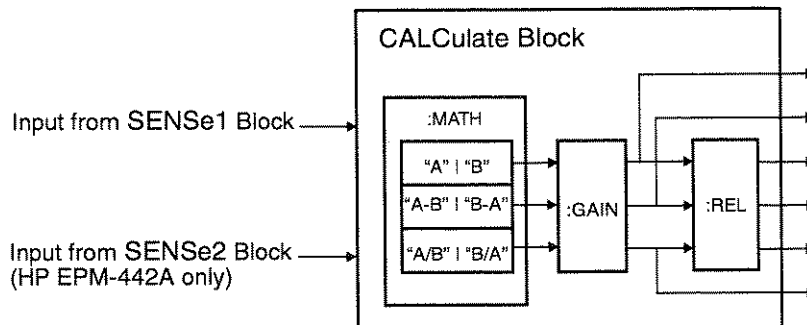

The CALCulate[1|2]:GAIN Node

This node is used to enter and enable a display offset on the specified window. The display offset is applied to the measurement signal after any math calculation.

The commands associated with this block are:

```
CALCulate[1|2]:GAIN[:MAGNitude] <numeric value>  
CALCulate[1|2]:GAIN:STATE <Boolean>
```

CALCulate Subsystem
CALCulate[1|2]:GAIN[:MAGNitude] <numeric_value>

CALCulate[1|2]:GAIN[:MAGNitude] <numeric_value>

This command is used to enter a value for the display offset on the specified window. The display offset is applied to the measurement signal after any math calculation.

Entering a value using this command automatically turns the CALCulate[1|2]:GAIN:STATE command to ON.

Syntax

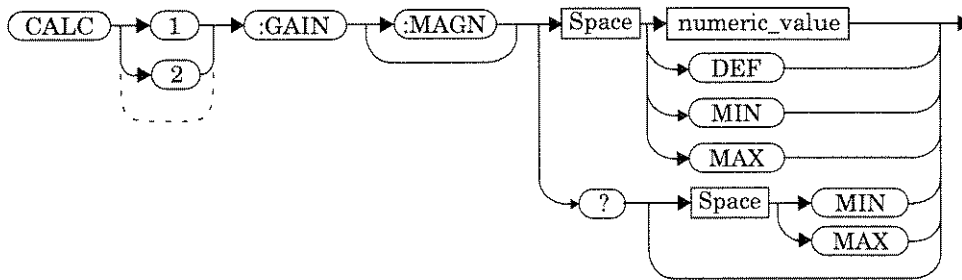

Parameters

Item	Description/Default	Range of Values
numeric_value	A numeric value. The default value, DEF, is 0 dB. The value for MIN is -100.000 dB. The value for MAX is +100.000 dB.	-100.000 to +100.000 dB DEF MIN MAX

Example

CALC2:GAIN 20

This command enters a display offset of 20 dB to the lower window.

Reset Condition

On reset, the display offset is set to 0 dB (DEF).

Query

CALCulate[1|2]:GAIN[:MAGNitude]? [MIN|MAX]

The query returns the current setting of the display offset or the value associated with MIN and MAX.

Query Example

CALC1:GAIN?

This command queries the current setting of the display offset on the upper window.

Error Message

If CALCulate[1|2]:GAIN[:MAGNitude] is set to ON while SENSE:SPEEd is set to 200, the error -221, "Settings Conflict" occurs.

CALCulate[1|2]:GAIN:STATe <Boolean>

This command is used on the specified window to enable and disable the display offset set by the CALCulate[1|2]:GAIN[:MAGNitude] command.

Syntax

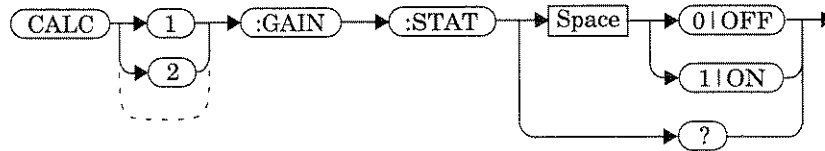

Example

```
CALC2:GAIN:STAT 1
```

This command enables the display offset set for the lower window.

Reset Condition

On reset, the gain is disabled.

Query

```
CALCulate[1|2]:GAIN:STATe?
```

The query enters a 1 or 0 into the output buffer indicating the status of the display offset.

- 1 is returned when the display offset feature is enabled.
- 0 is returned when the display offset feature is disabled.

Query Example

```
CALC1:GAIN:STAT?
```

This command queries whether the display offset on the upper window is on or off.

Error Message

If CALCulate[1|2]:GAIN:STATe is set to ON while SENSE:SPEEd is set to 200, the error -221, "Settings Conflict" occurs.

The CALCulate[1|2]:MATH Node

This node is a generic SCPI calculate sub-block which can be specified to define and carry out mathematical transformation on SENSE data. In the power meter a windows math block is used to set whether the window is measuring in single channel, difference or ratio modes.

The commands associated with this node are:

```
CALCulate[1|2]:MATH[:EXPRession]  
CALCulate[1|2]:MATH[:EXPRession]:CATalog?
```

CALCulate[1|2]:MATH[:EXPRession] <string>

This command is used to set the specified window to a single channel, difference or ratio measurement.

Syntax

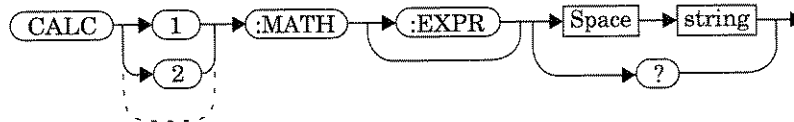

Parameters

Item	Description/Default	Range of Values
string	A single string value detailing the measurement type. For the HP EPM-441A the default is SENS1. For the HP EPM-442A the default is SENS1 if the upper window is selected or SENS2 if the lower window is selected.	" (SENS1) " ¹ " (SENS2) " ^{1,2} " (SENS1 - SENS2) " ^{1,2} " (SENS2 - SENS1) " ^{1,2} " (SENS1 / SENS2) " ^{1,2} " (SENS2 / SENS1) " ^{1,2}

1. Either single or double quotes may be used. However, quotes are mandatory.
2. HP EPM-442A only.

Example

`CALC2:MATH " (SENS2 / SENS1) "` *This command sets the lower window to make a channel B/A ratio measurement.*

Reset Condition

On reset, the HP EPM-441A upper and lower windows are both set to channel A (" (SENS1) "). On the HP EPM-442A the upper window is set to channel A (" (SENS1) ") and the lower window to channel B (" (SENS2) ").

Query

CALCulate[1|2]:MATH[:EXPRession]?

The query returns the current math measurement setting on the specified window.

Query Example

CALC1:MATH?

This command queries the current setting of the math expression on the upper window.

Error Messages

For the HP EPM-442A, if CALCulate1:MATH is set to anything other than SENS1 while SENSE:SPEed is set to 200, the error -221, "Settings Conflict" occurs.

For the HP EPM-442A, if CALCulate2:MATH is set to anything other than SENS2 while SENSE:SPEed is set to 200, the error -221, "Settings Conflict" occurs.

CALCulate[1|2]:MATH[:EXPRession]:CATalog?

This query lists all the defined expressions. The response is a list of comma separated strings. Each string contains an expression.

For the HP EPM-441A the string is:

" (SENS1) "

For the HP EPM-442A the string is:

" (SENS1) ", " (SENS2) ", " (SENS1/SENS2) ",
" (SENS2/SENS1) ", " (SENS1-SENS2) ", " (SENS2-SENS1) "

Syntax

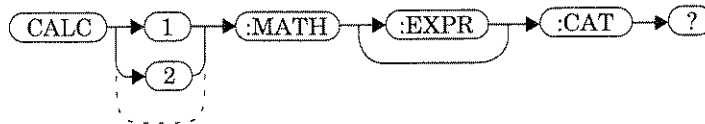

Example

CALC1:MATH:CAT?

This command lists all the defined math expressions.

The CALCulate[1|2]:RELative Node

This node contains commands which allow you to compare the measurement signal to a reference value.

Within the CALCulate block the relative value is applied to the measurement signal after any math calculations and display offsets have been applied.

The commands associated with this node are:

```
CALCulate[1|2]:RELative[:MAGNitude]:AUTO <Boolean>|ONCE  
CALCulate[1|2]:RELative:STATe <Boolean>
```

CALCulate Subsystem
CALCulate[1|2]:RELative[:MAGNitude]:AUTO <Boolean>|ONCE

CALCulate[1|2]:RELative[:MAGNitude]:AUTO <Boolean>|ONCE

This command is used to set the reference value to be used in the relative measurement. Within the CALCulate block the relative value is applied to the measurement signal after any math calculations and display offsets have been applied.

This command should be set to ONCE to set the reference value to be used in relative measurements. Selecting ONCE sets the reference value to being that of the measurement signal after any math calculations and display offsets have been applied. After the reference value has been set the command returns to OFF. Setting this command to ONCE turns the CALCulate[1|2]:RELative:STATE command to ON.

If 0|OFF is selected, no reference value is applied to the measurement signal. There is no situation in which you would want to send this command with OFF. OFF is only available because it is required for the query response.

If 1|ON is selected, it causes the error -224, "Illegal parameter value" to occur.

Syntax

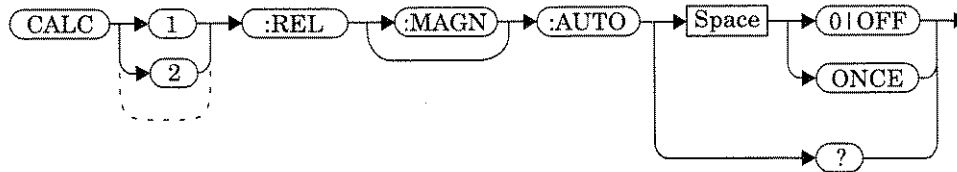

Example

```
CALC1:REL:AUTO ONCE
```

This command sets a reference value to be used in the relative measurement on the upper window.

Query

CALCulate[1|2]:RELative[:MAGNitude]:AUTO?

The query always returns OFF.

Error Message

If CALCulate:RELative[:MAGNitude]:AUTO is set to ONCE while SENSE:SPEEd is set to 200, the error -221, "Settings Conflict" occurs.

If this command is set to ON the error -224, "Illegal parameter value" occurs.

CALCulate[1|2]:RELative:STATe <Boolean>

This command is used to enable and disable relative mode. If the command is:

- disabled, the measurement signal remains unchanged.
- enabled, the current relative value set by CALCulate:RELative:MAGnitude:AUTO is applied to the measurement signal.

Syntax

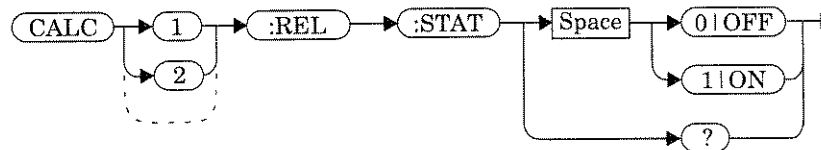

Example

```
CALC1:REL:STAT OFF
```

This command disables the relative mode on the upper window.

Reset Condition

On reset, relative mode is disabled.

Query

```
CALCulate[1|2]:RELative:STATe?
```

The query returns a 1 or 0 into the output buffer.

- 1 is returned when relative mode is enabled.
- 0 is returned when relative mode is disabled.

Query Example

```
CALC1:REL:STAT?
```

This command queries whether relative mode is off or on.

Error Message

If CALCulate:RELative:STATe is set to ON while SENSE:SPeEd is set to 200, the error -221, "Settings Conflict" occurs.

4

CALibration Subsystem

CALibration Subsystem

The CALibration command subsystem is used to zero and calibrate the power meter. It is also used to set the reference calibration factor for the power sensor which is being used.

The numeric suffix of the CALibration program mnemonic in the CALibration commands refers to a channel, that is CALibration1 and CALibration2 represent channel A and channel B respectively. If you are using the single channel HP EPM-441A power meter the CALibration2 commands are irrelevant and cause the error "Header suffix out of range."

Zeroing and calibration of the power meter is recommended:

- when a 5°C change in temperature occurs.
- when you change the power sensor.
- every 24 hours.
- prior to measuring low level signals. For example, 10 dB above the lowest specified power for your sensor.

The CALibration commands, with the exception of RCFactor, are all overlapped commands, that is, the power meter can continue parsing and executing subsequent commands while initiated. Refer to "Using the Operation Complete Commands", on page 1-78 to determine when the commands are complete.

Keyword	Parameter Form	Notes	Page
CALibration[1 2]			
[:ALL]		[event; no query]	page 4-3
[:ALL]?		[event;query]	page 4-5
:AUTO	<Boolean> ONCE		page 4-7
:RCFactor	<numeric_value>	[non-SCPI]	page 4-9
:ZERO			
:ZERO :AUTO	<Boolean> ONCE		page 4-11

CALibration[1|2][:ALL]

Note This command is identical to CALibration[1|2] [:ALL]?, however, unlike the query it does not provide a response to indicate whether the calibration has been successful or not.

This command causes the power meter to perform a calibration sequence on the specified channel. The command assumes that the power sensor is connected to the POWER REF output. The calibration sequence consists of:

- Zeroing the power meter (CALibration:ZERO:AUTO ONCE), and
- calibrating the power meter (CALibration:AUTO ONCE).

For the HP 8480 series power sensors the reference calibration factor used during this calibration can be derived from either an active sensor calibration table or the value entered using CALibration:RCFactor. The actual value used is the one which was most recently set. That is, a value entered using CALibration:RCFactor is overridden if a sensor calibration table is subsequently selected and enabled. Conversely, CALibration:RCFactor overrides any reference calibration factor previously set from a sensor calibration table. To determine the currently set reference calibration factor use CALibration:RCFactor?

The HP E-series power sensors have their sensor calibration tables stored in EEPROM which means that the reference calibration factor is automatically downloaded by the power meter.

Syntax

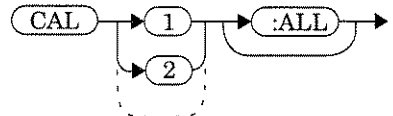

Example

CAL1:ALL

This command causes the power meter to perform a calibration sequence on channel A.

CALibration Subsystem
CALibration[1|2][:ALL]

Error Message

If the calibration was not carried out successfully the error -231, "Data Questionable; CAL ERROR" occurs. If you are using the HP EPM-442A the error message specifies on which channel the calibration failed.

If zeroing was not carried out successfully the error -231, "Data Questionable; ZERO ERROR" occurs. If you are using the HP EPM-442A the error message specifies on which channel the calibration failed.

CALibration[1|2][:ALL]?

Note This query is identical to CALibration[1|2][:ALL], however, unlike the command, this query provides a response to indicate whether the calibration has been successful or not.

This query causes the power meter to perform a calibration sequence on the specified channel. The query assumes that the power sensor is connected to the POWER REF output. The calibration sequence consists of:

- Zeroing the power meter (CALibration:ZERO:AUTO ONCE), and
- calibrating the power meter (CALibration:AUTO ONCE).

When the calibration sequence is completed, 0 or 1 is entered into the output buffer to indicate if the sequence was successful. If the result is:

- 0, the calibration has passed.
- 1, the calibration has failed.

For the HP 8480 series power sensors the reference calibration factor used during this calibration can be derived from either an active sensor calibration table or the value entered using CALibration:RCFactor. The actual value used is the one which was most recently set. That is, a value entered using CALibration:RCFactor is overridden if a sensor calibration table is subsequently selected and enabled. Conversely, CALibration:RCFactor overrides any reference calibration factor previously set from a sensor calibration table. To determine the currently set reference calibration factor use CALibration:RCFactor?

The HP E-series power sensors have their sensor calibration tables stored in EEPROM which means that the reference calibration factor is automatically downloaded by the power meter.

Syntax

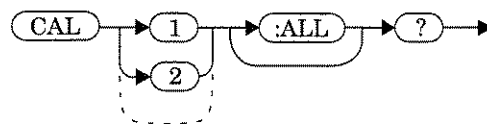

CALibration Subsystem
CALibration[1|2][:ALL]?

Query Example

CAL1:ALL?

This command causes the power meter to perform a calibration sequence on channel A and return a result.

Error Message

If the calibration was not carried out successfully the error -231, "Data Questionable; CAL ERROR" occurs. If you are using the HP EPM-442A the error message specifies on which channel the calibration failed.

If zeroing was not carried out successfully the error -231, "Data Questionable; ZERO ERROR" occurs. If you are using the HP EPM-442A the error message specifies on which channel the calibration failed.

CALibration[1|2]:AUTO <Boolean>IONCE

This command is used to calibrate the specified channel when ONCE is selected. The command assumes that the power sensor is connected to a 1 mW reference signal. The 0|OFF parameter is only required for the query response and is ignored in the command. If 1|ON is selected, it causes the error -224, "Illegal parameter value" to occur.

For the HP 8480 series power sensors the reference calibration factor used during this calibration can be derived from either an active sensor calibration table or the value entered using CALibration:RCFactor. The actual value used is the one which was most recently set. That is, a value entered using CALibration:RCFactor is overridden if a sensor calibration table is subsequently selected and enabled. Conversely, CALibration:RCFactor overrides any reference calibration factor previously set from a sensor calibration table. To determine the currently set reference calibration factor use CALibration:RCFactor?

The HP E-series power sensors have their sensor calibration tables stored in EEPROM which means that the reference calibration factor is automatically downloaded by the power meter.

Note The power meter should be zeroed before calibration using the CALibration:ZERO:AUTO ONCE command.

Syntax

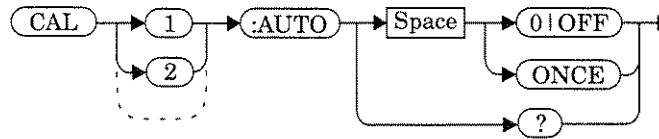

Example

CAL1:AUTO ONCE

This command causes the power meter to perform a calibration on channel A.

Reset Condition

On reset, automatic calibration is disabled.

CALibration Subsystem
CALibration[1|2]:AUTO <Boolean>|ONCE

Query

CALibration[1|2]:AUTO?

The query always returns a value of 0.

Error Message

If the calibration was not carried out successfully the error -231, "Data Questionable; CAL ERROR" occurs. If you are using the HP EPM-442A the error message specifies on which channel the calibration failed.

If this command is set to ON the error -224, "Illegal parameter value" occurs.

CALibration[1|2]:RCFactor <numeric_value>

This command is used with HP 8480 series power sensors to set the reference calibration factor of the specified channel. Reference calibration factors can also be set using sensor calibration tables. The power meter uses the most recently set reference calibration factor.

Syntax

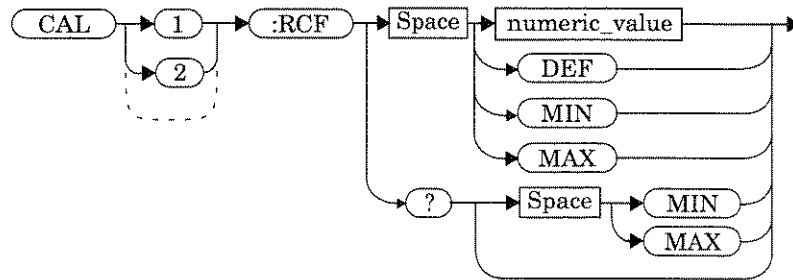

Parameters

Item	Description/Default	Range of Values
numeric_value	A numeric value. The default value, DEF, is 100%. The value for MIN is 1%. The value for MAX is 150%.	1.0 to 150.0PCT DEF MIN MAX

Example

CAL1:RCF 98

This command enters a reference calibration factor of 98% to channel A.

Reset Condition

On reset, the reference calibration factor is set to 100%.

CALibration Subsystem
CALibration[1|2]:RCFactor <numeric_value>

Query

CALibration[1|2]:RCFactor? [MIN|MAX]

The query returns the current setting of the reference calibration factor or the values associated with MIN and MAX.

Query Example

CAL2:RCF?

This command queries the reference calibration factor of channel B.

Error Message

If this command is used when an HP E-series power sensor is connected the error -241, "Hardware missing" occurs.

CALibration[1|2]:ZERO:AUTO <Boolean>|ONCE

This command causes the power meter to perform its zeroing routine on the specified channel when **ONCE** is selected. Zeroing takes approximately 10 seconds. This adjusts the power meter for a zero power reading with no power supplied to the power sensor. The **0|OFF** parameter is only required for the query response and is ignored in the command. If **1|ON** is selected, it causes the error -224, "Illegal parameter value" to occur.

The command assumes that the power sensor is not connected to a power source.

Syntax

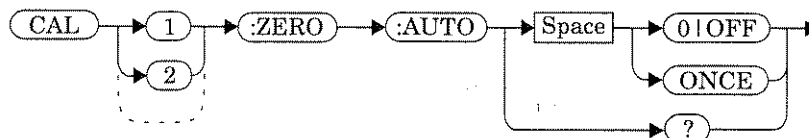

Example

```
CAL2:ZERO:AUTO ONCE
```

This command causes the power meter to perform a zeroing routine on channel B.

Reset Condition

On reset, automatic zeroing is disabled.

Query

```
CALibration[1|2]:ZERO:AUTO?
```

The query always returns a value of 0.

Error Message

If zeroing was not carried out successfully the error -231, "Data Questionable; ZERO ERROR" occurs. If you are using the HP EPM-442A the error message specifies on which channel the calibration failed.

If this command is set to **ON** the error -224, "Illegal parameter value" occurs.

CALibration Subsystem
CALibration[112]:ZERO:AUTO <Boolean>IONCE

5

DISPlay Subsystem

DISPlay Subsystem

The DISPlay subsystem is used to control the selection and presentation of the windows used on the power meter's display.

Keyword	Parameter Form	Notes	Page
DISPlay			
:CONTRast	<numeric_value>		page 5-3
:ENABle	<Boolean>		page 5-5
[:WINDow[1 2]]			
:FORMat	<character_data>	[non-SCPI]	page 5-7
:METer			
:LOWer	<numeric_value>	[non-SCPI]	page 5-10
:UPPer	<numeric_value>	[non-SCPI]	page 5-12
:RESolution	<numeric_value>	[non-SCPI]	page 5-14
:SElect		[non-SCPI]	page 5-16
[:STATe]	<Boolean>		page 5-17

DISPlay:CONTRast <numeric_value>

This command is used to control the display contrast. A contrast of:

- 0, represents a minimum contrast.
- 1, represents a maximum contrast.

When the supply power is cycled off then on the contrast sets to the factory default for that particular power meter.

Syntax

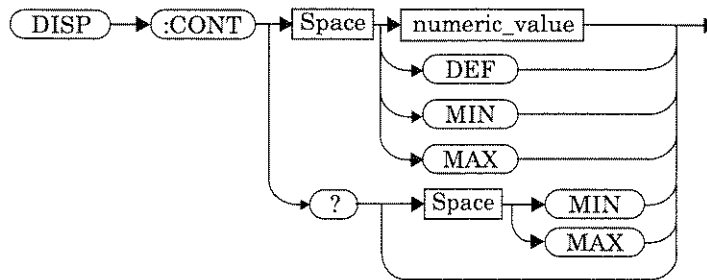

Parameters

Item	Description/Default	Range of Values
numeric_value	A numeric value for the contrast level. The default, DEF, is the factory default and can vary between power meters. The value for MIN is 0. The value for MAX is 1.	0 to 1 DEF MIN MAX

Example

DISP:CONT 0.75

This command sets the display contrast to 0.75.

Reset Condition

On reset, the contrast is not affected.

DISPlay Subsystem
DISPlay:CONTRast <numeric_value>

Query

DISPlay:CONTRast? [MIN|MAX]

The query returns the current setting of the contrast or the values associated with MIN and MAX. The response format is <NR3>.

Query Example

DISP:CONT?

This command queries the current contrast setting.

DISPlay:ENABLE <Boolean>

This command is used to enable and disable the display. At power-up the display is always enabled.

Syntax

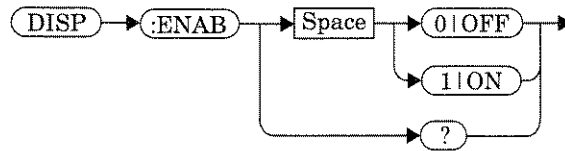

Example

```
DISP:ENAB 0
```

This command disables the display.

Reset Condition

On reset, the display is enabled.

Query

```
DISPlay:ENAB?
```

The query returns a 1 or 0 into the output buffer.

- 1 is returned when the display is enabled.
- 0 is returned when the display is disabled.

Query Example

```
DISP:ENAB?
```

This command queries whether the display is on or off.

DISPlay[:WINDow[1|2]] Node

This node is used to control various characteristics of the display windows.

The numeric suffix of the WINDow program mnemonic in the DISPlay commands refers to a window, that is WINDow1 and WINDow2 represent the upper and lower windows respectively.

The commands associated with this node are:

```
DISPlay[:WINDow[1|2]]:FORMat <character_data>  
DISPlay[:WINDow[1|2]]:METer:LOWer <numeric_value>  
DISPlay[:WINDow[1|2]]:METer:UPPer <numeric_value>  
DISPlay[:WINDow[1|2]]:RESolution <numeric_value>  
DISPlay[:WINDow[1|2]]:SElect  
DISPlay[:WINDow[1|2]][:STATE] <Boolean>
```

DISPlay[:WINDow[1|2]]:FORMat <character_data>

This command is used to select the format, either analog or digital, of the selected window.

Syntax

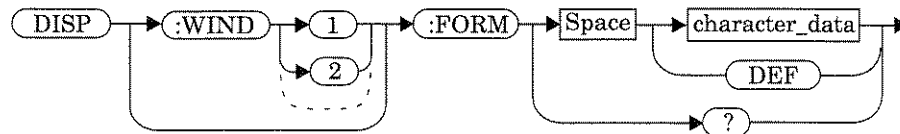

Parameters

Item	Description/Default	Range of Values
character_data	Character data for the window format. For the HP EPM-441A the default for the upper window is DIGital and ANALog for the lower window. For the HP EPM-442A the defaults for the upper and lower windows are DIGital.	DIGital ANALog DEF

Example

DISP:WIND2:FORM DIG

This command sets the lower window to a digital display.

Reset Condition

On reset, the HP EPM-441A upper window is DIGital and the lower window ANALog. For the HP EPM-442A the defaults for the upper and lower windows are DIGital.

Query

DISPlay: [WINDow[1|2]]:FORMat?

The query returns the current format of the selected window, either ANAL or DIG.

DISPlay Subsystem
DISPlay[:WINDow[1|2]]:FORMat <character_data>

Query Example

DISP:FORM?

This command queries the current format of the upper window.

DISPlay[:WINDow[1|2]]:METer Node

This command node is used to control the upper and lower limits of the analog meter.

The commands associated with this node are:

```
DISPlay[:WINDow[1|2]]:METer:LOWer <numeric_value>
```

```
DISPlay[:WINDow[1|2]]:METer:UPPer <numeric_value>
```

DISPlay Subsystem
 DISPlay[:WINDow[1|2]]:METer:LOWer <numeric_value>

DISPlay[:WINDow[1|2]]:METer:LOWer <numeric_value>

This command is used to set the analog meter lower limit. The units used are dependent on the current setting of UNIT:POWer and CALCulate:RELative:STATe as shown in Table 5-1.

Table 5-1: Measurement Units

Measurement Mode	CALC:REL:STAT OFF		CALC:REL:STAT ON	
	Linear	Log	Linear	Log
Single Channel	Watt	dBm	%	dB
Ratio	%	dB	%	dB
Difference	Watt	dBm	%	dB

Syntax

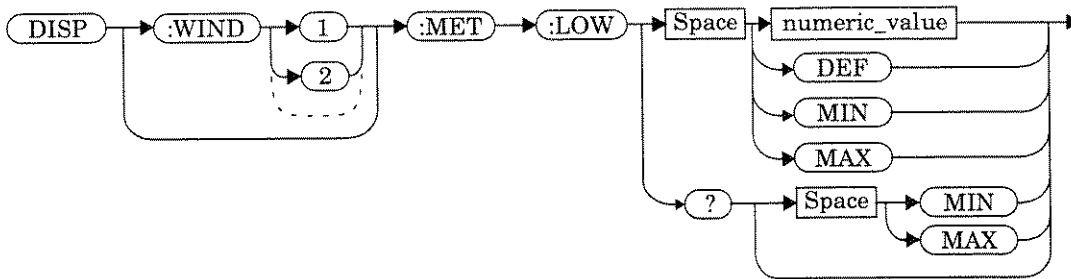

Parameters

Item	Description/Default	Range of Values
numeric_value	A numeric value for the analog meter lower limit. The default, DEF, is -70 dBm. The value for MIN is -150 dBm. The value for MAX is 230 dBm. The default units are defined by UNIT:POWer and CALCulate:RELative:STATe.	-150 to 230 dBm DEF MIN MAX

Example

DISP:WIND2:MET:LOW 10 *This command sets the lower window's analog meter lower limit.*

Reset Condition

On reset, the lower limit is set to -70 dBm (DEF).

Query

DISPlay[:WINDow[1|2]]:METer:LOWer? [MIN|MAX]

The query returns the current setting of the analog meter's lower limit or the value associated with MIN and MAX. The format of the response is <NR3>. The units in which the results are returned is dependent on the current setting of UNIT:POWER and CALCulate:RELative:STATE as shown in Table 5-1.

Query Example

DISP:MET:LOW? *This command queries the lower limit set on the analog meter in the upper window.*

DISPlay Subsystem
DISPlay[:WINDow[1|2]]:METer:UPPer <numeric_value>

DISPlay[:WINDow[1|2]]:METer:UPPer <numeric_value>

This command is used to set the analog meter upper limit. The units used are dependent on the current setting of UNIT:POWER and CALCulate:RELative:STATE as shown in Table 5-1.

Table 5-2: Measurement Units

Measurement Mode	CALC:REL:STAT OFF		CALC:REL:STAT ON	
	Linear	Log	Linear	Log
Single Channel	Watt	dBm	%	dB
Ratio	%	dB	%	dB
Difference	Watt	dBm	%	dB

Syntax

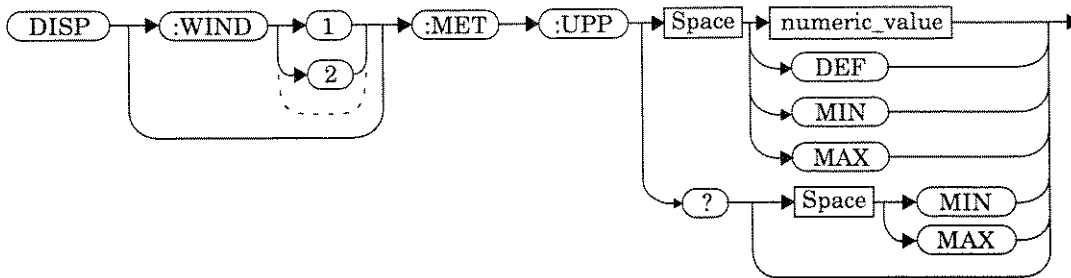

Parameters

Item	Description/Default	Range of Values
numeric_value	A numeric value for the analog meter upper limit. The default, DEF, is 20 dBm. The value for MIN is -150 dBm. The value for MAX is 230 dBm. The default units are defined by UNIT:POWER. The default units are defined by UNIT:POWER and CALCulate:RELative:STATE.	-150 to 230 dBm DEF MIN MAX

Example

```
DISP:WIND2:MET:UPP 20
```

This command sets the lower window's analog meter upper limit.

Reset Condition

On reset, the upper limit is set to 20 dBm (DEF).

Query

```
DISPlay[:WINDow[1|2]]:METer:UPPer? [MIN|MAX]
```

The query returns the current setting of the analog meter's upper limit or the value associated with MIN and MAX. The format of the response is <NR3>. The units in which the results are returned is dependent on the current setting of UNIT:POWER and CALCulate:RELative:STATE as shown in Table 5-1.

Query Example

```
DISP:WIND2:MET:UPP?
```

This command queries the upper limit set on the analog meter in the lower window.

DISPlay[:WINDow[1|2]]:RESolution <numeric_value>

This command is used to set the resolution of the measurement result in the selected window.

When the measurement result is linear this parameter represents the number of significant digits. When the measurement result is logarithmic 1 through 4 represents a resolution of 1, 0.1, 0.01, and 0.001 respectively.

The resolution set for the measurement window also affects the level of averaging in the SENSE subsystem when auto averaging is selected. Also, as a measurement from a selected channel may be displayed in more than one window (either directly as a single channel measurement or with a ratio or difference measurement (HP EPM-442A only)) there is a defined relationship between the window resolution and the resolution used to determine the auto averaging level. The resolution level used to determine auto averaging for a selected channel is the greater of the resolutions set for all windows in which the channel is displayed.

Syntax

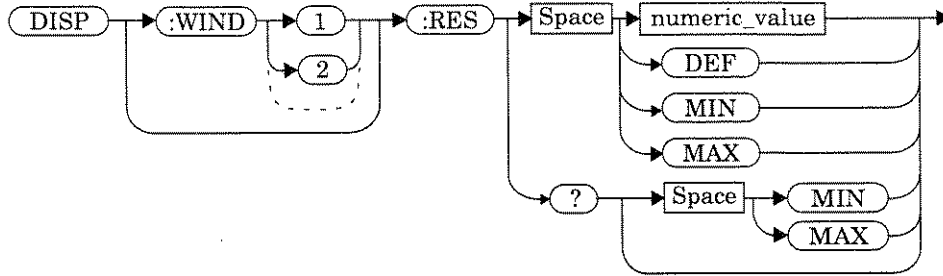

Parameters

Item	Description/Default	Range of Values
numeric_value	A numeric value for the window resolution. DEF is 3, MIN is 1, and MAX is 4.	1 2 3 4 DEF MIN MAX

Example

DISP:WIND2:RES 4

This command sets the lower window's resolution to 4 significant digits if the measurement result is linear or 0.001 if the measurement result is logarithmic.

Reset Condition

On reset, the resolution is set to 3 (DEF).

Query

DISPlay[:WINDow[1|2]]:RESolution? [MIN|MAX]

The query returns the current setting of the window's resolution or the value associated with MIN and MAX. The format of the response is <NR1>.

Query Example

DISP:RES?

This command queries the resolution setting of the upper window.

DISPlay[:WINDow[1|2]]:SElect

This command is used to determine which window is currently selected.

Syntax

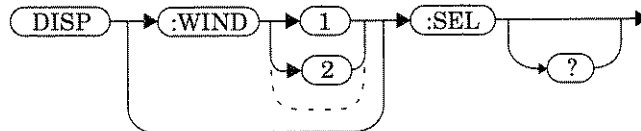

Example

```
DISP:WIND2:SEL
```

This command selects the lower window.

Reset Condition

On reset, the upper window is selected.

Query

```
DISPlay[:WINDow[1|2]]:SElect?
```

The query enters a 1 or 0 into the output buffer indicating whether the window specified is currently selected.

- 1 is returned if the specified window is selected.
- 0 is returned if the specified window is not selected.

Query Example

```
DISP:SEL?
```

This command queries whether or not the upper window is selected.

DISPlay[:WINDow[1|2]][:STATe] <Boolean>

This command is used to enable and disable the selected window, therefore allowing you to toggle between single and dual measurement window's on the display.

Only one window can be disabled at any one time. If you disable the only remaining window then the other window is automatically enabled and becomes the currently active window.

Syntax

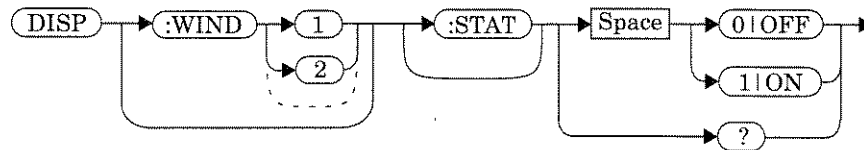

Example

```
DISP:WIND1:STAT 1
DISP:WIND2:STAT 1
```

This command enables both the upper and lower window giving a dual measurement display.

Reset Condition

On reset, both windows are enabled.

Query

```
DISPlay [:WINDow[1|2]] :STATe?
```

The query enters a 1 or 0 into the output buffer indicating the state of the selected window.

- 1 is returned if the window is enabled.
- 0 is returned if the window is disabled.

Query Example

```
DISP:WIND2:STAT?
```

This command queries whether or not the lower window is displayed.

DISPlay Subsystem
DISPlay[:WINDow[1|2]][:STATe] <Boolean>

6

FORMat Subsystem

FORMat Subsystem

The FORMat subsystem sets a data format for transferring numeric information. This data format is used only for response data by those commands that are specifically designated to be affected by the FORMat subsystem.

For the HP EPM-442A the same FORMat is used on both channels.

The queries that are affected are:

- FETCh?
- READ?
- MEASure?

When the format type is ASCII, numeric data is output as ASCII bytes in the <NR3> format.

When the format type is real, numeric data is output as a definite length block as IEEE 754 64 bit floating point numbers. The result is an 8 byte block per number.

Keyword	Parameter Form	Notes	Page
FORMat			
[:READings]			
:BORDER	NORMAL SWAPPED		page 6-3
[:DATA]	<Type>		page 6-4

FORMat[:READings]:BORDER NORMAlSWAPped

This command is used to control whether the binary data is transferred in normal or swapped Byte ORDER. It is only used when FORMat[:READings][:DATA] is set to REAL.

Syntax

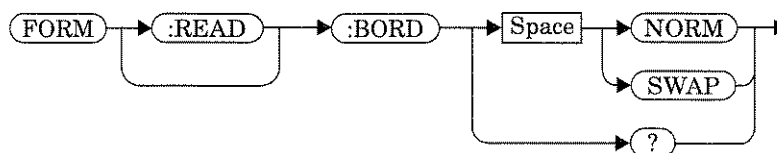

Example

FORM:BORDER SWAP

This command sets the byte order to swapped.

Reset Condition

On reset, this value is set to NORMAl.

Query

FORMat[:READings]:BORDER?

The query returns the current setting of the byte order. The format of the response is <character_data>.

Query Example

FORM:BORDER?

This command queries the current byte order setting.

FORMat[:READings][:DATA] <Type>

This command is used to set the data format to either ASCii or REAL.

Syntax



Parameters

Item	Description/Default	Range of Values
Type	Character data (not string).	ASCii REAL

Example

```
FORM REAL
```

This command sets the format to real.

Reset Condition

On reset, the format is set to ASCii.

Query

```
FORMat[:READings][:DATA]?
```

The query returns the current setting of format. The format of the response is <character_data>.

Query Example

```
FORM?
```

This command queries the current format setting.

FORMat Subsystem
FORMat[:READings][:DATA] <Type>

FORMat Subsystem
FORMat[:READings][:DATA] <Type>

7

MEMory Subsystem

MEMory Subsystem
MEMory Subsystem

MEMory Subsystem

The MEMory command subsystem is used to create, edit and review sensor calibration tables. This facility can be used to store sensor calibration tables for the HP 8480 series power sensors. The sensor calibration tables remain stored in the power meter's memory during power down. The power meter is capable of storing 20 sensor calibration tables of 80 frequency points each.

The power meter automatically downloads the HP E-series power sensors calibration tables. These tables cannot be reviewed or edited.

This subsystem is also used to create and review save/recall registers.

Keyword	Parameter Form	Notes	Page
MEMory			
:CATalog			
[:ALL]?		[query only]	page 7-4
:STATe?		[query only]	page 7-6
:TABLE?		[query only]	page 7-7
:CLEar			
[:NAME]	<string>	[no query], [non-SCPI]	page 7-10
:TABLE		[no query]	page 7-11
:FREE			
[:ALL]?		[query only]	page 7-13
:STATe?		[query only]	page 7-14
:TABLE?		[query only]	page 7-15
:NSTATes?		[query only]	page 7-16
:STATe			
:CATalog?		[query only]	page 7-18
:DEFine	<string> [, <numeric_value>]	[non-SCPI]	page 7-19
:TABLE			
:FREQUency	<numeric_value> [, <numeric_value>]		page 7-22
:POINTs?		[query only]	page 7-25
:GAIN			
[:MAGNitude]	<numeric_value> [, <numeric_value>]	[non-SCPI]	page 7-26
:POINTs?		[query only], [non-SCPI]	page 7-28
:MOVE	<string>, <string>	[no query], [non-SCPI]	page 7-29
:SElect	<string>	[no query], [non-SCPI]	page 7-30

MEMory:CATalog Node

This node is used to query information on the current contents of the power meter's sensor calibration tables and save/recall registers.

The commands associated with this node are:

```
MEMory:CATalog[:ALL]?  
MEMory:CATalog:STATe?  
MEMory:CATalog:TABLE?
```

MEMory:CATalog[:ALL]?

This command is used to list the stored sensor calibration tables and save/recall registers.

The power meter returns the data in the form of two numeric parameters and as many strings as there are stored sensor calibration tables and save/recall registers.

`<numeric_value>, <numeric_value>{, <string>}`

- The first numeric parameter indicates the amount of memory, in bytes, used for the storage of tables and registers.
- The second numeric parameter indicates the memory, in bytes, available for the storage of tables and registers.
- Each string parameter returned indicates the name, type and size of a stored sensor calibration table or save/recall register:
 - `<string>, <type>, <size>`
 - ◆ `<string>` indicates the name of the sensor calibration table or save/recall register.
 - ◆ `<type>` indicates TABL for a sensor calibration table or STAT for a save/recall register.
 - ◆ `<size>` indicates the size of the sensor calibration table or save/recall register in bytes.

For example, a sample of a response may look like:

```
1178, 26230, "DEFAULT, TABL, 14", "HP8481A, TABL, 116",  
"HP8482A, TABL, 74", ..... "State0, STAT, 1619",  
"State1, STAT, 1619", "State2, STAT, 1619" .....
```



The power meter is shipped with a set of predefined sensor calibration tables. The data in these sensor calibration tables is based on statistical averages for a range of Hewlett-Packard power sensors. These tables can be altered. The predefined data is listed in your *User's Guide*. These power sensors are:

Table	Power Sensor	Table Name
0	None	DEFAULT ¹
1	HP 8481A	HP8481A
2	HP 8482A, HP 8482B, HP 8482H	HP8482A
3	HP 8483A	HP8483A
4	HP 8481D	HP8481D
5	HP 8485A	HP8485A
6	HP R8486A	R8486A
7	HP Q8486A	Q8486A
8	HP R8486D	R8486D
9	HP 8487A	HP8487A

1. Default is a sensor calibration table in which the reference calibration factor and calibration factors are 100%. This sensor calibration table can be used during the performance testing of the power meter.

There are also ten sensor calibration tables named CUSTOM_0 through CUSTOM_9 which do not contain any data when the power meter is shipped from the factory.

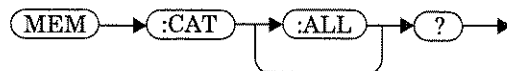
Syntax



Example

MEM:CAT?

This command queries the list of stored sensor calibration tables and save / recall registers.

MEMory:CATalog:STATe?

This command is used to list the save/recall registers.

The power meter returns the data in the form of two numeric parameters and as many strings as there are save/recall registers.

<numeric_value>, <numeric_value>{, <string>}

- The first numeric parameter indicates the amount of memory, in bytes, used for the storage of registers.
- The second parameter indicates the memory, in bytes, available for the storage of registers.
- Each string parameter returned indicates the name, type and size of a save/recall register:
 - <string>, <type>, <size>
 - ♦ <string> indicates the name of the save/recall register.
 - ♦ <type> indicates STAT for save/recall register.
 - ♦ <size> indicates the size of the save/recall register in bytes.

For example, a sample of a response may look like:

0,16190, "State0, STAT, 0", "State1, STAT, 0"

Syntax



Example

MEM:CAT:STAT?

This command queries the list of save/recall registers.

MEMory:CATalog:TABLE?

This command is used to list the stored sensor calibration tables.

The power meter returns the data in the form of two numeric parameters and as many strings as there are stored sensor calibration tables.

<numeric_value>, <numeric_value>{, <string>}

- The first numeric parameter indicates the amount of memory, in bytes, used for the storage of tables.
- The second parameter indicates the memory, in bytes, available for the storage of tables.
- Each string parameter returned indicates the name, type and size of a stored sensor calibration table:
 - <string>, <type>, <size>
 - ◆ <string> indicates the name of the sensor calibration table.
 - ◆ <type> indicates TABL for a sensor calibration table.
 - ◆ <size> indicates the size of the sensor calibration table in bytes.

For example, a sample of a response may look like:

```
1178,10040,"DEFAULT,TABL,14","HP8481A,TABL,116",  
"HP8482A,TABL,74","HP8483A,TABL,62".....
```

MEMory Subsystem
MEMory:CATalog:TABLE?

The power meter is shipped with a set of predefined sensor calibration tables. The data in these sensor calibration tables is based on statistical averages for a range of Hewlett-Packard power sensors. These tables can be altered. The predefined data is listed in your *User's Guide*. These power sensors are:

Table	Power Sensor	Table Name
0	None	DEFAULT ¹
1	HP 8481A	HP8481A
2	HP 8482A, HP 8482B, HP 8482H	HP8482A
3	HP 8483A	HP8483A
4	HP 8481D	HP8481D
5	HP 8485A	HP8485A
6	HP R8486A	R8486A
7	HP Q8486A	Q8486A
8	HP R8486D	R8486D
9	HP 8487A	HP8487A

1. Default is a sensor calibration table in which the reference calibration factor and calibration factors are 100%. This sensor calibration table can be used during the performance testing of the power meter.

There are also ten sensor calibration tables named CUSTOM_0 through CUSTOM_9 which do not contain any data when the power meter is shipped from the factory.

Syntax

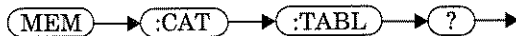

Example

MEM:CAT:TABLE?

This command queries the list of stored sensor calibration tables.

MEMory:CLEar Node

This node is used to remove the contents stored in the sensor calibration tables and save/recall registers. This subsystem removes the data contents but does not affect the name of the associated sensor calibration table or save/recall register.

The commands associated with this node are:

```
MEMory:CLEar:[NAME] <string>  
MEMory:CLEar:TABLE
```

Note The contents cleared using these commands are non-recoverable.

MEMory Subsystem
MEMory:CLEar[:NAME] <string>

MEMory:CLEar[:NAME] <string>

This command is used to clear the contents of a given sensor calibration table or save/recall register.

Although the sensor calibration table remains, a MEMory:TABLE:FREQuency|GAIN:POINTs? query returns a 0 as there are no contents in the sensor calibration table.

For sensor calibration tables this command is an alternative form of the MEMory:CLEar:TABLE command, the only difference being the method in which the sensor calibration table is selected.

Note The contents cleared using this command are non-recoverable.

Syntax



Parameters

Item	Description/Default	Range of Values
string	String data.	Any existing sensor calibration table name or save/recall register.

Example

```
MEM:CLE "HP8485A"
```

This command clears the contents of sensor calibration table HP 8485A

Error Messages

If the sensor calibration table or save/recall register name does not exist error -224, "Illegal parameter value" occurs.

MEMory:CLEar:TABLE

This command is used to clear the contents of the sensor calibration table, currently selected using `MEMory:TABLE:SElect`. Although the sensor calibration table remains, a `MEMory:TABLE:FREQuency|GAIN:POINTs?` query returns a 0 as there are no contents in the sensor calibration table.

For sensor calibration tables, this command is an alternative form of the `MEMory:CLEar[:NAME]` command, the only difference being the method in which the sensor calibration table is selected.

Note The contents cleared using this command are non-recoverable.

Syntax



Example

```
MEM:CLE:TABL
```

This command clears the contents of the currently selected sensor calibration table.

Error Message

If no sensor calibration table is selected error -221, "Settings conflict" occurs.

MEMory Subsystem
The MEMory:FREE Node

The MEMory:FREE Node

This node is used to return information on the amount of free memory space available for sensor calibration tables and save/recall registers.

The commands associated with this node are:

MEMory:FREE[:ALL]?

MEMory:FREE:STATE?

MEMory:FREE:TABLE?

MEMory:FREE[:ALL]?

This query returns the amount of memory free for both the sensor calibration tables and save/recall registers. The format of the response is:

<bytes_available>, <bytes_in_use>

Syntax

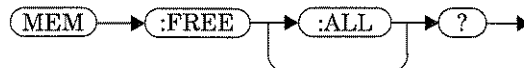

Example

MEM:FREE?

This command queries the amount of free memory in total.

MEMory Subsystem
MEMory:FREE:STATe?

MEMory:FREE:STATe?

This query returns the amount of memory free for save/recall registers.
The format of the response is:

<bytes_available>, <bytes_in_use>

Syntax

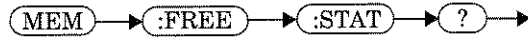

Example

MEM:FREE:STAT?

This command queries the amount of free memory for save / recall registers.

MEMory:FREE:TABLE?

This query returns the amount of memory free for sensor calibration tables. The format of the response is:

<bytes_available>, <bytes_in_use>

Syntax

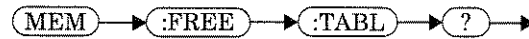

Example

MEM:FREE:TABLE?

This command queries the amount of free memory for sensor calibration tables.

MEMory:NSTates?

This query returns the number of registers that are available for save/recall. As there are ten registers this query always returns ten.

Syntax



Example

MEM:NST?

This command queries the number of registers available for save / recall.

The MEMory:STATe Node

This node is used to query and define register names.

The commands associated with this node are:

MEMory:STATe:CATalog?
MEMory:STATe:DEFine

MEMory Subsystem
MEMory:STATe:CATalog?

MEMory:STATe:CATalog?

This query returns a list of the save/recall register names in ascending order of register number. The format of the response is:

<string>,<string>,...,<string>

Syntax

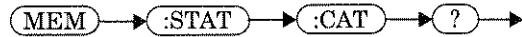

Example

MEM:STAT:CAT?

This command queries the register names.

MEMory:STATe:DEFine <string>,<numeric_value>

This command is used to associate a name with a save/recall register number.

Syntax

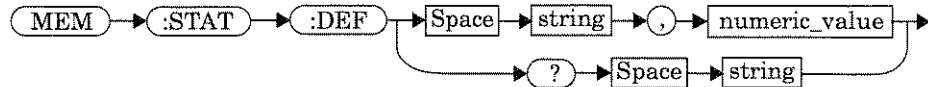

Parameters

Item	Description/Default	Range of Values
string	A string detailing the register name. A maximum of 12 characters can be used.	A to Z (uppercase) a to z (lowercase) 0 - 9 _ (underscore)
numeric_value	A numeric value (<Nrf>) for the register number.	0 to 9

Example

MEM:STAT:DEF "SETUP1",4 *This command names register 4 SETUP1.*

Query

MEMory:STATe:DEFine? <string>

The query returns the register number for the given register name.

Query Example

MEM:STAT:DEF? "SETUP1" *This command queries the register number of SETUP1.*

MEMory Subsystem

MEMory:STATe:DEFine <string>,<numeric_value>

Error Messages

If the register number is out of range, error -222, "Data out of range" occurs.

If the name is invalid, error -224, "Illegal parameter value" occurs.

If a register or sensor calibration table with the same name already exists, error -257, "File name error" occurs (command only).

MEMory:TABLE Node

This node is used to define a sensor calibration table and to write to and read data from it.

The commands associated with this node are:

```
MEMory:TABLE:FREQuency <numeric_value>{,<numeric_value>}
MEMory:TABLE:FREQuency:POINts?
MEMory:TABLE:GAIN[:MAGNitude]
    <numeric_value>{,<numeric_value>}
MEMory:TABLE:GAIN[:MAGNitude]:POINts?
MEMory:TABLE:MOVE <string>,<string>
MEMory:TABLE:SElect <string>
```

MEMory:TABLE:FREQuency <numeric_value>{,<numeric_value>}

This command is used to enter frequency data into the current sensor calibration table. Any previous frequency list is cleared before the new frequencies are stored. The frequencies must be entered in ascending order. Entries in the frequency lists correspond as shown with entries in the calibration factor lists. The first calibration factor entered using the MEMory:TABLE:GAIN command is used as the reference calibration factor.

Frequency	Calibration Factor
-	Reference Calibration Factor
Frequency 1	Calibration Factor 1
Frequency 2	Calibration Factor 2
"	"
Frequency 80	Calibration Factor 80

The number of frequency points must be one less than the number of calibration factor points. This is verified when the sensor calibration table is selected using SENSE:CORREction:CSET:SElect <string>.

Ensure that the frequency points you use cover the frequency range of the signals that you want to measure. If you measure a signal with a frequency outside the frequency range defined in the sensor calibration table then the power meter uses the highest or lowest point in the sensor calibration table to calculate the calibration factor.

The power meter is capable of storing 20 tables of 80 frequency points.

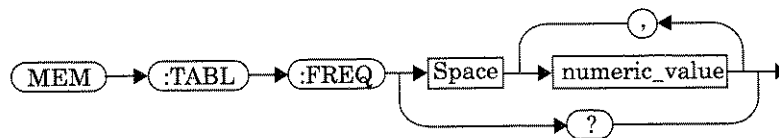
Syntax

Parameters

Item	Description/Default	Range of Values
numeric_value	A numeric value for the frequency. The default units are Hz.	1 kHz to 999.9 GHz ^{1, 2}

1. The following measurement units can be used:

- Hz
- kHz (10³)
- MHz (10⁶)
- GHz (10⁹)

2. All frequencies are truncated to a multiple of 1 kHz.

Example

MEM:TABLE:FREQ 200kHz,600kHz

This command enters frequencies of 200 kHz and 600 kHz into the currently selected sensor calibration table.

Query

MEMory:TABLE:FREQuency?

The query returns a list of frequency points for the sensor calibration table currently selected. The frequencies are returned in Hz.

Query Example

MEM:TABLE:FREQ?

This command queries the frequency points in the currently selected sensor calibration table.

MEMory Subsystem

MEMory:TABLE:FREQuency <numeric_value>{,<numeric_value>}

Error Messages

If more than 80 frequencies are in the list, error -108, "Parameter not allowed" occurs.

If the frequencies are not entered in ascending order, error -220, "Parameter error;Frequency list must be in ascending order" occurs.

If a sensor calibration table has not been specified using the MEMory:TABLE:SElect command, the data cannot be entered into the sensor calibration table and error -221, "Settings conflict" occurs.

If a frequency is sent which is outwith the allowed frequency range, error -222, "Data out of range" occurs.

MEMory:TABLE:FREQuency:POINts?

This query returns the number of frequency points for the sensor calibration table currently selected. The response format is <NRf>. If no frequency values have been set, this command returns 0. If no sensor calibration table is selected, this command returns NAN.

Syntax



Example

MEM:TABLE:FREQ:POIN?

This command queries the number of frequency points in the current sensor calibration table.

MEMory:TABLE:GAIN[:MAGNitude] <numeric_value>{,<numeric_value>}

MEMory:TABLE:GAIN[:MAGNitude] <numeric_value>{,<numeric_value>}

This command is used to enter calibration factors into the sensor calibration table currently selected using `MEMory:TABLE:SElect`. Any previous calibration factor list is cleared before the new calibration factors are stored.

A maximum of 81 parameters can be sent with this command. The first parameter is the reference calibration factor, each subsequent parameter is a calibration factor point in the sensor calibration table.

Entries in the frequency lists correspond as shown with entries in the calibration factor lists.

Calibration Factor	Frequency
Reference Calibration Factor	-
Calibration Factor 1	Frequency 1
"	"
Calibration Factor 80	Frequency 80

The number of frequency points must be one less than the number of calibration factor data points. This is verified when the sensor calibration table is selected using `SENSE:CORREction:CSET:SElect <string>`.

Syntax

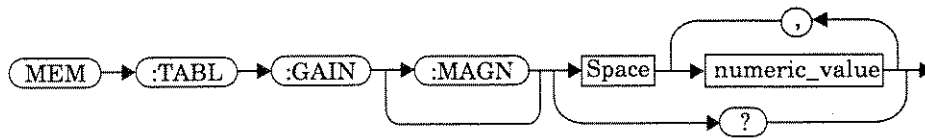

Parameters

Item	Description/Default	Range of Values
numeric_value	A numeric value for the calibration factors. The units are PCT.	1.0 to 150.0

MEMory:TABLE:GAIN[:MAGNitude] <numeric_value>{,<numeric_value>}**Example**

```
MEM:TABLE:GAIN 97,99.5,97.4
```

This command enters a reference calibration factor of 97% and calibration factors of 99.5% and 97.4% into the current sensor calibration table.

Query

```
MEMory:TABLE:GAIN[:MAGNitude]?
```

The query returns a list of calibration factor points for the currently selected sensor calibration table.

Query Example

```
MEM:TABLE:GAIN?
```

This command queries the calibration factors in the current sensor calibration table.

Error Messages

If more than 81 calibration factors are in the list, error -108, "Parameter not allowed" occurs.

If a sensor calibration table is not specified using the `MEMory:TABLE:SElect` command, the data cannot be entered and error -221, "Settings conflict" occurs.

If any of the calibration factors are outwith the allowed range, error -222, "Data out of range" occurs.

MEMory:TABLE:GAIN[:MAGNitude]:POINTs?

This query is used to return the number of calibration factor points including the reference calibration factor for the currently selected sensor calibration table.

If no values have been sent, 0 is returned. If no sensor calibration table is selected, NAN is returned.

Syntax

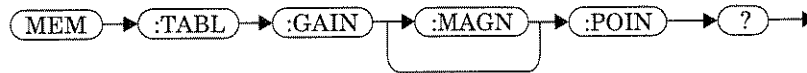

Example

MEM:TABLE:GAIN:POIN?

This command queries the number of calibration points in the current sensor calibration table.

MEMory:TABLE:MOVE <string>,<string>

This command is used to rename a sensor calibration table.

Syntax



Parameters

Item	Description/Default	Range of Values
string (1st parameter)	A string containing the existing table name.	existing table name
string (2nd parameter)	A string detailing the register name. A maximum of 12 characters can be used.	A to Z (uppercase) a to z (lowercase) 0 - 9 _ (underscore)

Example

MEM:TABLE:MOVE "tab1", "tab1a" *This command renames a table named tab1 to tab1a.*

Error Messages

If either sensor calibration table name is invalid, error -224, "Illegal parameter value" occurs.

If the first parameter does not match an existing table name, error -256, "File name not found" occurs.

If the second parameter matches an existing table name or save/recall register, error -257, "File name error" occurs.

MEMory:TABLE:SElect <string>

This command is used to activate a sensor calibration table. A sensor calibration table must be activated before any operation can be performed on it.

Syntax



Parameters

Item	Description/Default	Range of Values
string	A string detailing the sensor calibration table name. A maximum of 12 characters can be used.	A to Z (uppercase) a to z (lowercase) 0 - 9 _ (underscore)

Example

MEM:TABLE:SEL "Sensor1"

This command selects a sensor calibration table named "Sensor1".

Query

MEMory:TABLE:SElect?

The query returns the name of the currently selected sensor calibration table.

8

———— **OUTput Subsystem**

OUTput Subsystem
OUTPut Subsystem

OUTPut Subsystem

The **OUTPut** command subsystem is used to switch on and off the **POWER REF** output.

Keyword	Parameter Form	Notes	Page
OUTPut :ROSCillator [:STATe]	<Boolean>		page 8-3

OUTPut:ROSCillator[:STATe] <Boolean>

This command is used to switch on and off the POWER REF output

Syntax

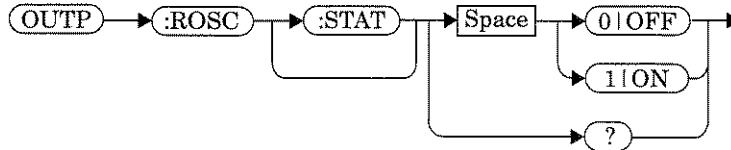

Example

OUTP:ROSC:STAT 1

This command switches on the POWER REF output.

Reset Condition

On reset, the POWER REF output is switched off.

Query

OUTPut:ROSCillator[:STATe]?

The query command enters a 1 or 0 into the output buffer indicating whether or not the POWER REF is switched on.

- 1 is returned when the POWER REF output is switched ON.
- 0 is returned when the POWER REF output is switched OFF.

Query Example

OUTP:ROSC?

This command queries the status off the POWER REF output.

OUTput Subsystem
OUTPut:ROSCillator[:STATe] <Boolean>

SENSe Subsystem

[SENSe] Subsystem

The `SENSe` command subsystem directly affects device specific settings used to make measurements. The `SENSe` node is optional since this is the primary function of the power meter. The high level command `CONFIgure` uses the `SENSe` commands to prepare the power meter for making measurements. At a lower level `SENSe` enables you to change the following parameters: `RANGe`, `FREQuency`, `LOSS`, `CFACator` | `GAIN1` (calibration factor), `GAIN2` (channel offset), `DCYClE` (duty cycle), and `AVERage`, without completely re-configuring the power meter.

The `SENSe` command subsystem also provides a limit checking function. This function allows you to set the power meter's upper and lower measurement limits. The power meter monitors the power level and indicates when these limits are exceeded.

The `SENSe` command subsystem also allows you to select the measurement speed and the sensor calibration table used for frequency correction.

The numeric suffix of the `SENSe` program mnemonic in the `SENSe` commands refers to a channel, that is `SENSe1` and `SENSe2` represent channel A and channel B respectively. If you are using the single channel HP EPM-441A power meter the `SENSe2` commands are irrelevant and cause the error "Header suffix out of range."

Keyword	Parameter Form	Notes	Page
[SENSe[1]] SENSe2			
:AVERage			
:COUNT	<numeric_value>		page 9-5
:AUTO	<Boolean> ONCE		page 9-7
[:STATe]	<Boolean>		page 9-10
:CORRection			
:CFACTOR GAIN1			
[:INPut]			
[:MAGNitude]	<numeric_value>		page 9-24
:CSET			
[:SElect]	<string>		page 9-13
:STATe	<Boolean>		page 9-15
:DCYCLe GAIN3			
[:INPut]			
[:MAGNitude]	<numeric_value>		page 9-18
:STATe	<Boolean>		page 9-21
:GAIN2			
[:INPut]			
[:MAGNitude]	<numeric_value>		page 9-24
:STATe	<Boolean>		page 9-27
:LOSS2			
[:INPut]			
[:MAGNitude]	<numeric_value>		page 9-30
:STATe	<Boolean>		page 9-32
:FREQuency			
[:CW] :FIXed	<numeric_value>		page 9-34
:LIMit			
:CLEar			
:AUTO	<Boolean> ONCE		page 9-37
[:IMMediate]		[no query]	page 9-39
:FAIL?		[query only]	page 9-40
:FCOUNT?		[query only]	page 9-41
:LOWer			
[:DATA]	<numeric_value>		page 9-43
:STATe	<Boolean>		page 9-45
:UPPer			
[:DATA]	<numeric_value>		page 9-46
:POWer			
:AC			
:RANGE	<numeric_value>	[non-SCPI]	page 9-48
:AUTO	<Boolean>		page 9-49
:SPEed	<numeric_value>	[non-SCPI]	page 9-51

[SENSe[1]]|SENSe2:AVERAge Node

This node controls averaging which is used to improve the measurement accuracy. The AVERAge subsystem combines successive measurements to produce a new composite result.

The commands associated with this node are:

```
[SENSe[1]]|SENSe2:AVERAge:COUNT <numeric_value>  
[SENSe[1]]|SENSe2:AVERAge:COUNT:AUTO <Boolean>  
[SENSe[1]]|SENSe2:AVERAge[:STATe] <Boolean>
```

[SENSe[1]]|SENSe2:AVERAge:COUNt <numeric_value>

This command is used to enter a value for the filter length. If [SENSe[1]]|SENSe2:AVERAge:COUNt:AUTO is set to ON then entering a value for the filter length automatically sets it to OFF. Increasing the value of filter length increases measurement accuracy but also increases the time taken to make a power measurement.

Entering a value using this command automatically turns the [SENSe[1]]|SENSe2:AVERAge:STATE command to ON.

Note

For most applications, automatic filter length selection ([SENSe[1]]|SENSe2:AVERAge:COUNt:AUTO ON) is the best mode of operation. However, manual filter length selection ([SENSe[1]]|SENSe2:AVERAge:COUNt <numeric_value>) is useful in applications requiring either high resolution or fast settling times.

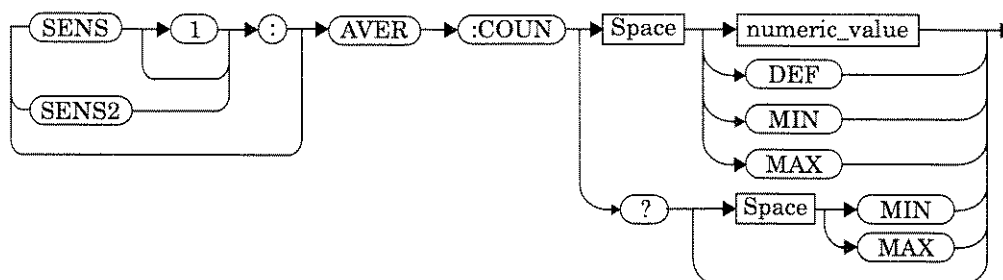
Syntax

SENSE Subsystem
 [SENSE[1]]|SENSE2:AVERAge:COUNT <numeric_value>

Parameters

Item	Description/Default	Range of Values
numeric_value	A numeric value defining the filter length. The default value, DEF, is 4. The value for MIN is 1. The value for MAX is 1024.	1 to 1024 ^{1, 2} DEF MIN MAX

1. If a numeric value is specified which is not a binary multiple, the power meter rounds the value to the nearest power of 2 within the range allowed. That is 5 is rounded to 4 and 7 is rounded to 8. If the filter length is exactly half way between to powers of two the length is rounded down (that is 6 rounds to 4).
2. In HP 437B remote programming language you cannot enter a value of 1024.

Example

AVER:COUN 400

This command enters a filter length of 400 for channel A. The power meter rounds this up to 512.

Reset Condition

On reset, the filter length is set to 4.

Query

AVERAge:COUNT? [MIN|MAX]

The query returns the current setting of the filter length or the values associated with MIN and MAX. The format of the response is <NR1>.

Query Example

AVER:COUN?

This command queries the filter length for channel A.

Error Message

If a filter length value is entered using [SENSE[1]]|SENSE2:AVERAge:COUNT while [SENSE[1]]|SENSE2:SPEEd is set to 200, the error -221, "Settings Conflict" occurs. However, the filter length value is set but the [SENSE[1]]|SENSE2:AVERAge:STATe command is not automatically set ON.

[SENSe[1]]|SENSe2:AVERAge:COUNT:AUTO <Boolean>IONCE

This command is used to enable and disable automatic averaging. **IONCE** has no affect on the power meter.

When the auto filter mode is enabled, the power meter automatically sets the number of readings averaged together to satisfy the averaging requirements for most power measurements. The number of readings averaged together depends on the resolution and the power level in which the power meter is currently operating. Figure 9-1 lists the number of readings averaged for each range and resolution when the power meter is in auto filter mode.

Setting this command to **ON** automatically sets the `[SENSe[1]]|SENSe2:AVERAge:STATe` command to **ON**.

Figure 9-1: Averaged Readings

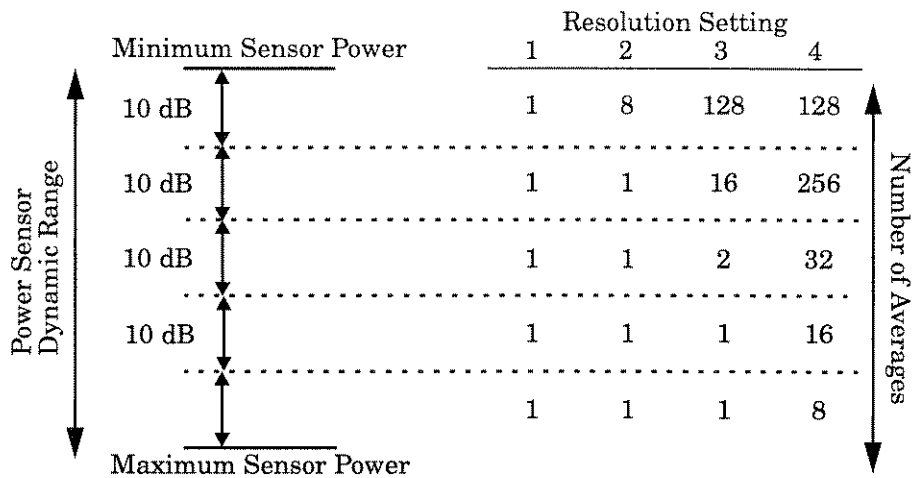

If `[SENSe[1]]|SENSe2:AVERAge:COUNT:AUTO` is set to **OFF**, the filter length is set by the `[SENSe[1]]|SENSe2:AVERAge:COUNT` command. Using the `[SENSe[1]]|SENSe2:AVERAge:COUNT` command automatically disables automatic averaging.

Auto averaging is enabled by the `MEASure:POWer:AC?` and `CONFigure:POWer:AC?` commands.

SENSe Subsystem
[SENSe[1]]|SENSe2:AVERAge:COUNT:AUTO <Boolean>|ONCE

Note For most applications, automatic filter length selection ([SENSe[1]]|SENSe2:AVERAge:COUNT:AUTO ON) is the best mode of operation. However, manual filter length selection ([SENSe[1]]|SENSe2:AVERAge:COUNT <numeric_value>) is useful in applications requiring either high resolution or fast settling times.

Syntax

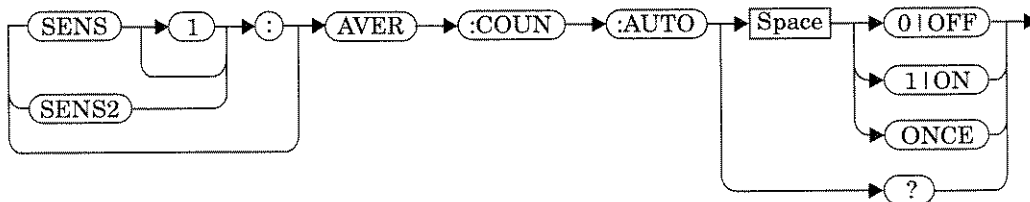

Example

AVER: COUN: AUTO OFF

This command disables automatic filter length selection for channel A.

Reset Condition

On reset, automatic averaging is enabled.

Query

[SENSe[1]]|SENSe2:AVERAge:COUNT:AUTO?

The query enters a 1 or 0 into the output buffer indicating whether automatic filter length is enabled or disabled.

- 1 is returned when automatic filter length is enabled.
- 0 is returned when automatic filter length is disabled.

Query Example

AVER: COUN: AUTO?

This command queries whether automatic filter length selection is on or off for channel A.

Error Message

If [SENSe[1]] | SENSe2:AVERage:COUNT:AUTO is set to ON while [SENSe[1]] | SENSe2:SPEEd is set to 200, the error -221, "Settings Conflict" occurs. However, automatic averaging is enabled but the [SENSe[1]] | SENSe2:AVERage:STATE command is not automatically set ON.

[SENSe[1]]|SENSe2:AVERage[:STATe] <Boolean>

This command is used to enable and disable averaging.

Syntax

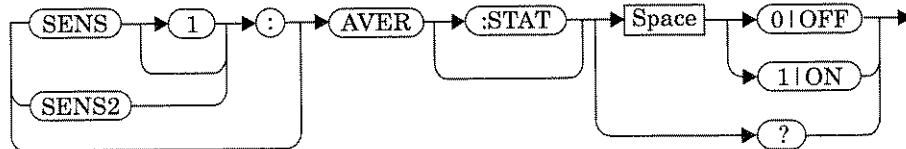

Example

AVER 1

This command enables averaging on channel A.

Reset Condition

On reset, averaging is enabled.

Query

[SENSe[1]]|SENSe2:AVERage[:STATe]?

The query enters a 1 or 0 into the output buffer indicating the status of averaging.

- 1 is returned when averaging is enabled.
- 0 is returned when averaging is disabled.

Query Example

SENS2:AVER?

This command queries whether averaging is on or off for channel B.

Error Message

If [SENSe[1]]|SENSe2:AVERage:STATe is set to ON while [SENSe[1]]|SENSe2:SPEed is set to 200, the error -221, "Settings Conflict" occurs.

[SENSe[1]]|SENSe2:CORRection Node

This node provides for known external losses or gains. These are used to enter duty cycle values, calibration factors and other external gains and losses.

The commands associated with this node are:

```
[SENSe[1]]|SENSe2:CORRection:CSET[:SElect] <string>  
[SENSe[1]]|SENSe2:CORRection:CSET:STATE <Boolean>  
[SENSe[1]]|SENSe2:CORRection:DCYCLE|GAIN3[:INPut]  
[:MAGNitude] <numeric_value>  
[SENSe[1]]|SENSe2:CORRection:DCYCLE|GAIN3:STATE <Boolean>  
[SENSe[1]]|SENSe2:CORRection:CFACTOR|GAIN[1|2][:INPut]  
[:MAGNitude] <numeric_value>  
[SENSe[1]]|SENSe2:CORRection:GAIN2:STATE <Boolean>  
[SENSe[1]]|SENSe2:CORRection:LOSS2[:INPut][:MAGNitude]  
<numeric_value>  
[SENSe[1]]|SENSe2:CORRection:LOSS2:STATE <Boolean>
```

SENSe Subsystem
[SENSe[1]]|SENSe2:CORRection:CSET Node

[SENSe[1]]|SENSe2:CORRection:CSET Node

This node is used to select the active sensor calibration table.

Note

These commands are only relevant with the HP 8480 series power sensors. If any of these commands are used when an HP E-series power sensor is connected the error -241, "Hardware missing" occurs.

The commands associated with this node are:

```
[SENSe[1]]|SENSe2:CORRection:CSET[:SELEct] <string>  
[SENSe[1]]|SENSe2:CORRection:CSET:STATe <Boolean>
```

[SENSe[1]]|SENSe2:CORRection:CSET[:SELEct] <string>

This command is used to enter the name of the sensor calibration table which is to be used to determine the calibration factors used for frequency correction. The calibration factor is interpolated from the table using the setting for [SENSe[1]]|SENSe2:FREQuency.

Note

If [SENSe[1]]|SENSe2:CORRection:CSET:STATE is set to OFF, the sensor calibration table is not being used.

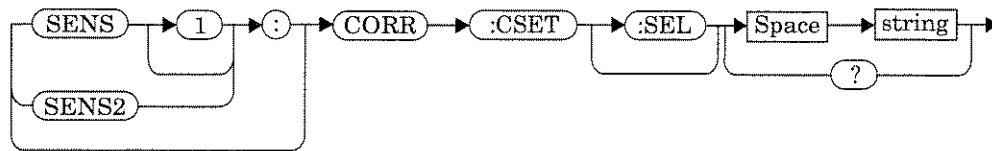
Syntax**Parameters**

Item	Description/Default	Range of Values
string	String data representing a sensor calibration table name.	Any existing table name. (To list names use MEMORY:CATalog:TABLE?.)

Example

```
CORR:CSET "PW1"
```

This command enters the name of the sensor calibration table which is to be used on channel A.

Reset Condition

On reset the selected table is not affected.

SENSE Subsystem
[SENSe[1]]|SENSe2:CORRection:CSET[:SELEct] <string>

Query

[SENSe[1]]|SENSe2:CORRection:CSET:[SELEct]?

The name of the sensor calibration table is returned as a quoted string. If no table is selected an empty string is returned.

Query Example

CORR:CSET?

This command queries the sensor calibration table currently used for channel A.

Error Messages

If <string> is not valid, error -224, "Illegal parameter value" occurs.

If a sensor calibration table called <string> does not exist, error -256, "File name not found" occurs.

When the sensor calibration table is selected, the power meter verifies that the number of calibration points defined is one more than the number of frequency points defined. If this is not the case, error -226, "Lists not the same length" occurs.

If this command is used when an HP E-series power sensor is connected the error -241, "Hardware missing" occurs.

[SENSe[1]]|SENSe2:CORRection:CSET:STATe <Boolean>

This command is used to enable and disable the use of the currently active sensor calibration table. When a sensor calibration table has been selected and enabled the calibration factors stored in it can be used by specifying the required frequency using the [SENSe[1]]|SENSe2:FREQuency command.

When this command is set to ON, the reference calibration factor is taken from the sensor calibration table and is used during calibration.

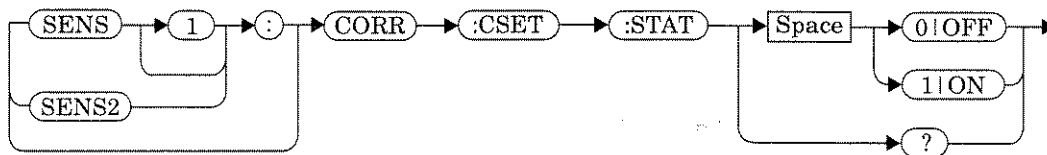
Syntax**Example**

```
CORR:CSET:STAT 1
```

This command enables the use of the currently active sensor calibration table for channel A.

Reset Condition

On reset, the sensor calibration table is not affected.

Query

```
[SENSe[1]]|SENSe2:CORRection:CSET:STATe?
```

The query returns a 1 or 0 into the output buffer indicating whether a sensor calibration table is enabled or disabled.

- 1 is returned when the sensor calibration table is enabled.
- 0 is returned when the sensor calibration table is disabled.

SENSe Subsystem
[SENSe[1]]|SENSe2:CORRection:CSET:STATe <Boolean>

Query Example

SENS2:CORR:CSET:STAT?

This command queries whether there is currently an active sensor calibration table for channel B.

Error Message

If you attempt to set this command to ON and no sensor calibration table has been selected using the [SENSe[1]]|SENSe2:CORRection:CSET:[SElect] command then error -221, "Settings conflict" occurs and [SENSe[1]]|SENSe2:CORRection:CSET:STATe remains OFF.

[SENSE[1]]|SENSE2:CORREction:DCYCLE|GAIN3 Node

This command node controls the pulse power measurement feature of the power meter.

The commands associated with this node are:

```
[SENSE[1]]|SENSE2:CORREction:DCYCLE|GAIN3[:INPut]
[:MAGNitude] <numeric_value>
```

```
[SENSE[1]]|SENSE2:CORREction:DCYCLE|GAIN3:STATE <Boolean>
```

Note

You can use either DCYCLE or GAIN3 in these commands, both do the same. Using GAIN3 complies with the SCPI standard whereas DCYCLE does not, but may make your program more understandable.

[SENSe[1]]|SENSe2:CORRection:DCYClE|GAIN3[:INPut][:MAGNitude] <numeric_value>

This command is used to set the duty cycle for the pulse power measurement feature of the power meter. Pulse power measurements average out any aberrations in the pulse such as overshoot or ringing. The result returned for a pulse power measurement is a mathematical representation of the pulse power rather than an actual measurement. The power meter measures the average power in the pulsed input signal and then divides the result by the duty cycle value to obtain a pulse power reading.

Entering a value using this command automatically turns the [SENSe[1]]|SENSe2:CORRection:DCYClE|GAIN3:STATe command to ON.

Note

Pulse measurements are not recommended using HP E-series power sensors at power levels above -20 dBm.

Pulse power averages out any aberrations in the pulse such as overshooting or ringing. For this reason it is called pulse power and not peak power or peak pulse power.

In order to ensure accurate pulse power readings, the input signal must be pulsed with a rectangular pulse. Other pulse shapes (such as triangle, chirp or Gaussian) will cause erroneous results.

The pulse power on/off ratio must be much greater than the duty cycle ratio.

Syntax

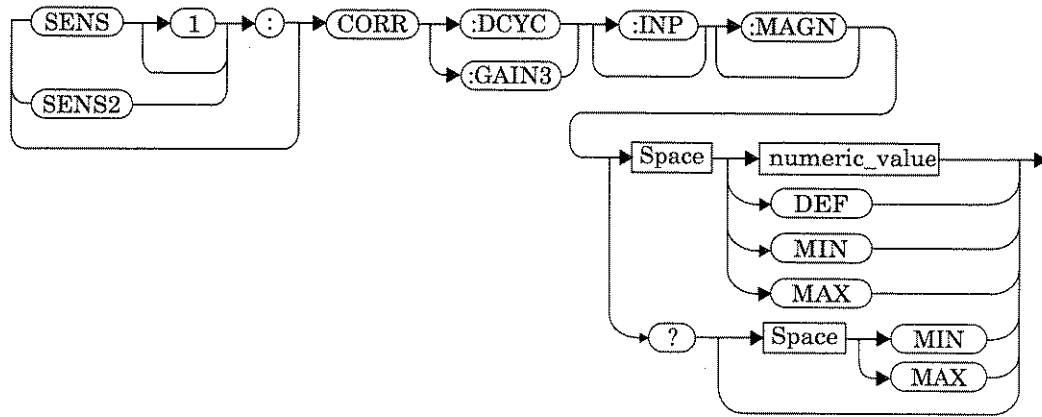

Parameters

Item	Description/Default	Range of Values
numeric_value	A numeric value for the duty cycle. The default value, DEF, is 1%. The value for MIN is 0.001%. The value for MAX is 99.999%. The units are PCT, and are optional.	0.001 to 99.999PCT DEF MIN MAX

Example

CORR:DCYC 90PCT

This command sets a duty cycle of 90% for channel A.

Reset Condition

On reset, the duty cycle is set to 1% (DEF).

Query

[SENSe[1]]|SENSe2:CORRection:DCYClE|GAIN3[:INPut][:MAGNitude]? [MIN|MAX]

The query returns the current setting of the duty cycle or the values associated with MIN and MAX.

SENSe Subsystem
[SENSe[1]]|SENSe2:CORRection:DCYCLe|GAIN3[:INPut][:MAGNitude]

Query Example

CORR:GAIN3?

This command queries the current setting of the duty cycle for channel A.

Error Messages

If a duty cycle value is entered using

[SENSe[1]]|SENSe2:CORRection:DCYCLe|GAIN3 while [SENSe[1]]|SENSe2:SPEEd is set to 200, the error -221, "Settings Conflict" occurs. However, the duty cycle value is set but the [SENSe[1]]|SENSe2:CORRection:DCYCLe|GAIN3:STATe command is not automatically set ON.

If this command is used when an HP E-series power sensor is connected, the error -310, "System error;Dty Cyc may impair accuracy with ECP sensor" occurs. If you are using the HP EPM-442A the error message specifies the channel.

[SENSe[1]]|SENSe2:CORRection:DCYClE|GAIN3:STATe <Boolean>

This command is used to enable and disable the pulse power measurement feature.

The [SENSe[1]]|SENSe2:CORRection:DCYClE|GAIN3 command should be used to enter the duty cycle of the signal you want to measure.

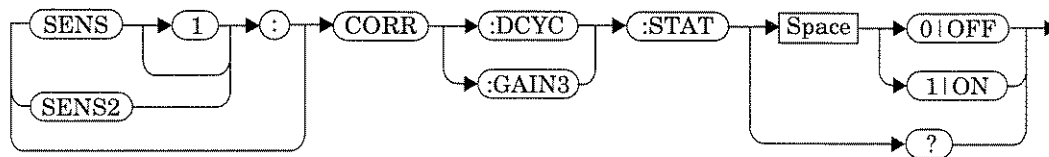
Syntax**Example**

```
CORR:DCYC:STAT 1
```

This command enables the pulse measurement feature on channel A.

Reset Condition

On reset, the pulse power measurement feature is disabled.

Query

```
[SENSe[1]]|SENSe2:CORRection:DCYClE|GAIN3:STATe?
```

The query enters a 1 or 0 into the output buffer indicating the status of the pulse power measurement feature.

- 1 is returned when the pulse power measurement feature is enabled.
- 0 is returned when the pulse power measurement feature is disabled.

SENSE Subsystem
[SENSE[1]]|SENSE2:CORRection:DCYCLE|GAIN3:STATe <Boolean>

Query Example

CORR:GAIN3:STAT?

This command queries whether the pulse measurement feature is on or off.

Error Messages

If [SENSE[1]]|SENSE2:CORRection:DCYCLE:STATUS is set to ON while [SENSE[1]]|SENSE2:SPEEd is set to 200, the error -221, "Settings Conflict" occurs.

If this command is used when an HP E-series power sensor is connected, the error -310, "System error;Dty Cyc may impair accuracy with ECP sensor" occurs. If you are using the HP EPM-442A the error message specifies the channel.

[SENSe[1]]|SENSe2:CORRection:GAIN[1|2] Node

This node is used to provide a simple correction to the measurement. It is possible to apply two corrections, one for the calibration factor (CFACTOR|GAIN1) and one for any other channel offset (GAIN2).

Note

The `SENSe[1]|SENSe2:CORRection:CFACTOR|GAIN1` command can be used for the HP 8480 series power sensors when no sensor calibration table has been set up. If a sensor calibration table is selected the error -221, "Settings Conflict" occurs.

Gain and loss correction are a coupled system. This means that a gain set by `[SENSe[1]]|SENSe2:CORRection:GAIN2` is represented in the `[SENSe[1]]|SENSe2:CORRection:LOSS2?` command. `LOSS2` is coupled to `GAIN2` by the equation:

$Loss = \frac{1}{Gain}$ when the default unit is linear, and

$Gain = -Loss$ when the default unit is logarithmic.

The commands associated with this node are:

```
[SENSe[1]]|SENSe2:CORRection:CFACTOR:GAIN[1|2][:INPut]
[:MAGNitude] <numeric_value>
[SENSe[1]]|SENSe2:CORRection:GAIN2:STATE <Boolean>
```

[SENSe[1]]|SENSe2:CORRection:CFACTOR|GAIN[1|2][:INPut][:MAGNitude] <numeric_value>

This command is used to enter a value for gain correction. The power meter corrects every measurement by this factor to compensate for the gain.

There are two gains which can be set:

- CFACTOR|GAIN1 is used to enter a gain correction value for the calibration factor.
You can use either CFACTOR or GAIN1 in this command, both do the same. Using GAIN1 complies with the SCPI standard whereas CFACTOR does not but may make your program more understandable.
- GAIN2 is used to enter an offset value to compensate for the power meter setup.
Entering a value for GAIN2 using this command automatically turns the [SENSe[1]]|SENSe2:CORRection:GAIN2:STATE command to ON.

Gain and loss correction are a coupled system. This means that a gain set by [SENSe[1]]|SENSe2:CORRection:GAIN2 is represented in the [SENSe[1]]|SENSe2:CORRection:LOSS2? command.

LOSS2 is coupled to GAIN2 by the equation:

Loss = $\frac{1}{\text{Gain}}$ when the default unit is linear, and

Gain = -Loss when the default unit is logarithmic.

Syntax

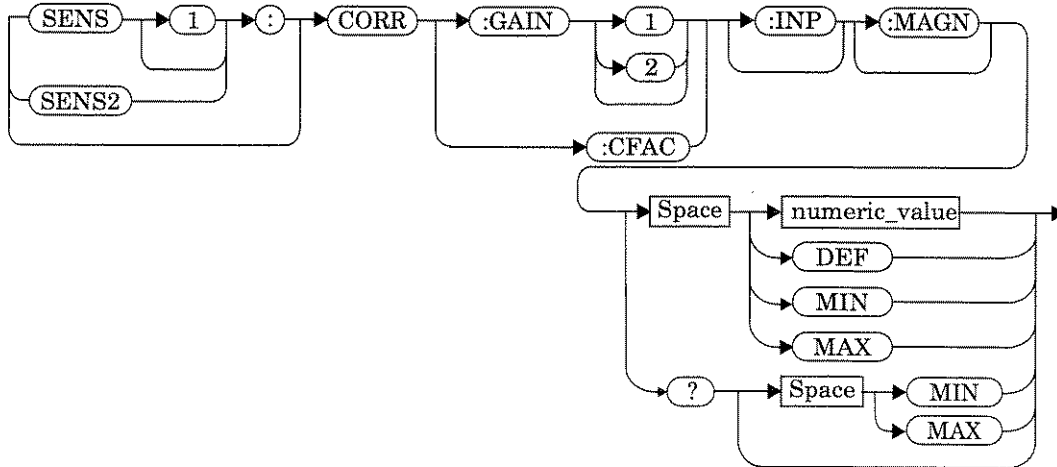

Parameters

Item	Description/Default	Range of Values
numeric_value (for CFACtor and GAIN1)	A numeric value. The default value, DEF, is 100%. The value for MIN is 1%. The value for MAX is 150%.	1 to 150PCT ¹ DEF MIN MAX
numeric_value (for GAIN2)	A numeric value. The default value, DEF, is 0.00 dB. The value for MIN is -100 dB. The value for MAX is +100 dB.	-100 to +100 dB DEF MIN MAX

1. For example, a gain of 60% corresponds to a multiplier of 0.6 and a gain of 150% corresponds to a multiplier of 1.5.

Example

SENS2:CORR:GAIN2 50

This command sets a channel offset of 50 dB for channel B.

Reset Condition

On reset, CFACtor | GAIN1 is set to 100% and GAIN2 to 0.0 dB.

SENSe Subsystem
[SENSe[1]]|SENSe2:CORRection:CFACTOR|GAIN[1|2][:INPut][:MAGNitude]

Query

[SENSe[1]]|SENSe2:CORRection:CFACTOR|GAIN[1|2][:INPut][:MAGNitude]? [MIN|MAX]

The query returns the current setting of the gain correction or the values associated with MIN and MAX.

If [SENSe[1]]|SENSe2:CORRection:LOSS2 is used to set a gain level, the result of this query is $\frac{1}{\text{Loss2}}$ when the default unit is linear, and -Loss2 when the default unit is logarithmic.

Query Example

CORR:GAIN1?

This command queries the current setting of the calibration factor on channel A.

Error Messages

If a channel offset value is entered using [SENSe[1]]|SENSe2:CORRection:GAIN2 while [SENSe[1]]|SENSe2:SPEEd is set to 200, the error -221, "Settings Conflict" occurs. However, the channel offset value is set but the [SENSe[1]]|SENSe2:CORRection:GAIN2:STATE command is not automatically set ON.

The [SENSe[1]]|SENSe2:CORRection:CFACTOR|GAIN1 command can be used for the HP 8480 series power sensors when no sensor calibration table has been set up. If a sensor calibration table is selected the error -221, "Settings Conflict" occurs.

[SENSe[1]]|SENSe2:CORRection:GAIN2:STATe <Boolean>

This command is used to enable and disable a channel offset for the power meter setup. Since GAIN2 and LOSS2 form a coupled system, the command is identical to

[SENSe[1]]|SENSe2:CORRection:LOSS2:STATe.

The [SENSe[1]]|SENSe2:CORRection:GAIN2 command should be used to enter the gain value.

Syntax

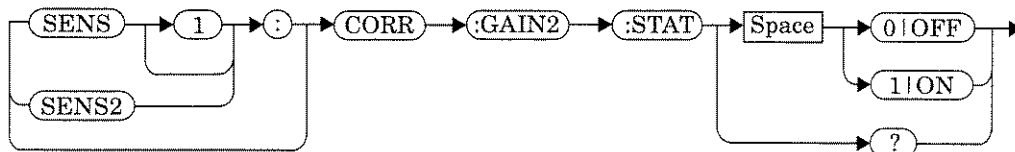

Example

CORR:GAIN2:STAT ON

This command enables a channel offset on channel A.

Reset Condition

On reset, channel offsets are disabled.

Query

[SENSe[1]]|SENSe2:CORRection:GAIN2:STATe?

The query enters 1 or 0 into the output buffer indicating the status of the channel offsets.

- 1 is returned if a channel offset is enabled.
- 0 is returned if a channel offset is disabled.

Query Example

CORR:GAIN2:STAT?

This command queries whether or not there is a channel offset applied to channel A.

SENSe Subsystem
[SENSe[1]]|SENSe2:CORRection:GAIN2:STATe <Boolean>

Error Message

If [SENSe[1]]|SENSe2:CORRection:GAIN2:STATe is set to ON while [SENSe[1]]|SENSe2:SPEEd is set to 200, the error -221, "Settings Conflict" occurs.

[SENSe[1]]|SENSe2:CORRection:LOSS2 Node

This node is used to provide a simple correction to the measurement for an external loss.

Loss and gain correction are a coupled system. This means that a loss set by [SENSe[1]]|SENSe2:CORRection:LOSS2 is represented in [SENSe[1]]|SENSe2:CORRection:GAIN2? command. LOSS2 is coupled to GAIN2 by the equation

Gain = $\frac{1}{\text{Loss}}$ when the default unit is linear, and

Loss = -Gain when the default is logarithmic.

The commands associated with this node are:

```
[SENSe[1]]|SENSe2:CORRection:LOSS2[:INPut][:MAGNitude]
    <numeric_value>
[SENSe[1]]|SENSe2:CORRection:LOSS2:STATe <Boolean>
```

[SENSe[1]]|SENSe2:CORRection:LOSS2[:INPut][:MAGNitude] <numeric_value>

This command is used to enter a channel offset value for the power meter setup, for example cable loss. The power meter then corrects every measurement by this factor to compensate for the loss.

Entering a value for LOSS2 using this command automatically turns the [SENSe[1]]|SENSe2:CORRection:LOSS2:STATe command to ON.

Loss and gain correction are a coupled system. This means that a loss set by [SENSe[1]]|SENSe2:CORRection:LOSS2 is represented in [SENSe[1]]|SENSe2:CORRection:GAIN2? command. LOSS2 is coupled to GAIN2 by the equation

$$\text{Gain} = \frac{1}{\text{Loss}}$$

when the default unit is linear, and

$$\text{Loss} = -\text{Gain}$$

when the default is logarithmic.

Syntax

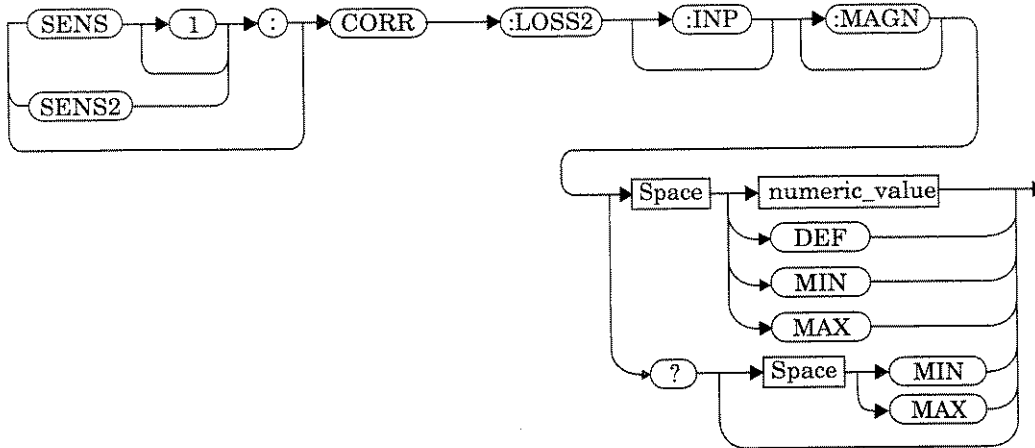

Parameters

Item	Description/Default	Range of Values
numeric_value	A numeric value. The default value, DEF, is 0.00 dB. The value for MIN is -100 dB. The value for MAX is +100 dB.	-100 to +100 dB DEF MIN MAX

[SENSE[1]]|SENSE2:CORRection:LOSS2[:INPut][:MAGNitude] <numeric_value>

Example

CORR:LOSS2 50

This command sets a channel offset of 50 dB for channel A.

Reset Condition

On reset, LOSS2 is set to 0.00 dB.

Query

[SENSE[1]]|SENSE2:CORRection:LOSS2[:INPut][:MAGNitude]? [MIN|MAX]

The query returns the current setting of the channel offset or the values associated with MIN and MAX.

If [SENSE[1]]|SENSE2:CORRection:GAIN2 is used to set a loss level, the result of this query is $\frac{1}{\text{Gain2}}$ when the default unit is linear, and $-\text{Gain2}$ when the default is logarithmic.

Query Example

CORR:LOSS2?

This command queries the current setting of the channel offset on channel A.

Error Message

If a loss correction value is entered using [SENSE[1]]|SENSE2:CORRection:LOSS2 while [SENSE[1]]|SENSE2:SPEEd is set to 200, the error -221, "Settings Conflict" occurs. However, the correction value is set but the [SENSE[1]]|SENSE2:CORRection:LOSS2:STATE command is not automatically set ON.

The [SENSE[1]]|SENSE2:CORRection:LOSS2 command can be used for the HP 8480 series power sensors when no sensor calibration table has been set up. If a sensor calibration table is selected the error -221, "Settings Conflict" occurs.

SENSe Subsystem
[SENSe[1]]|SENSe2:CORRection:LOSS2:STATe <Boolean>

[SENSe[1]]|SENSe2:CORRection:LOSS2:STATe <Boolean>

This command is used to enable and disable a loss correction for the power meter setup, for example cable loss. Since LOSS2 and GAIN2 form a coupled system, the command is identical to [SENSe[1]]|SENSe2:CORRection:GAIN2:STATe.

The [SENSe[1]]|SENSe2:CORRection:LOSS2 command should be used to enter the loss value.

Syntax

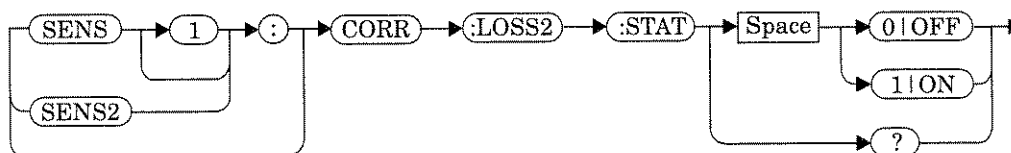

Example

SENS2:CORR:LOSS2:STAT 1

This command enables loss correction on channel B.

Reset Condition

On reset, loss correction is disabled.

Query

[SENSe[1]]|SENSe2:CORRection:LOSS2:STATe?

The query enters 1 or 0 into the output buffer indicating the status of the loss correction.

- 1 is returned if loss correction is enabled.
- 0 is returned if loss correction is disabled.

Query Example

CORR:LOSS2:STAT?

This command queries whether the loss correction on channel A is on or off.

SENSe Subsystem
[SENSe[1]]|SENSe2:CORRection:LOSS2:STATe <Boolean>

Error Message

If [SENSe[1]]|SENSe2:CORRection:LOSS2:STATe is set to ON while [SENSe[1]]|SENSe2:SPEEd is set to 200, the error -221, "Settings Conflict" occurs.

[SENSe[1]]|SENSe2:FREQuency[:CW|:FIXed] <numeric_value>

This command is used to enter a frequency. If the frequency does not correspond directly to a frequency in the sensor calibration table, the power meter calculates the calibration factor using linear interpolation. For HP 8480 series power sensors the power meter uses linear interpolation to calculate the calibration factor for the frequency entered if [SENSe[1]]|SENSe2:CORREction:CSET:STATE is ON. For HP E-series power sensors, the calibration factor is calculated using the sensor's calibration factor data held in its EEPROM.

Syntax

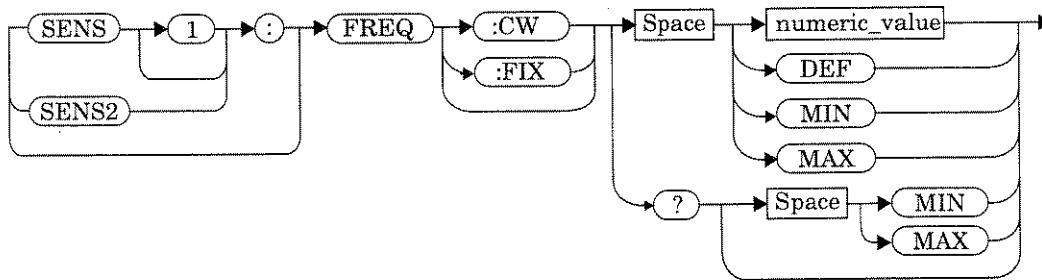

Parameters

Item	Description/Default	Range of Values
numeric_value	A numeric value for the frequency. The default value, DEF, is 50 MHz. The value for MIN is 1 kHz. The value for MAX is 999.999 GHz. The default units are HZ.	1 kHz to 999.999 GHz ¹ DEF MIN MAX

1. The following measurement units can be used:

- Hz
- kHz (10³)
- MHz (10⁶)
- GHz (10⁹)

[SENSe[1]]|SENSe2:FREQUency[:CW|:FIXed] <numeric_value>

Example

FREQ 500kHz

This command enters a channel A frequency of 500 kHz.

Reset Condition

On reset, the frequency is set to 50 MHz (DEF).

Query

[SENSe[1]]|SENSe2:FREQUency[:CW|:FIXed]? [MIN|MAX]

The query returns the current frequency setting or the values associated with MIN and MAX. The units in which the results are returned are Hz.

Query Example

SENS2:FREQ?

This command queries the channel B frequency setting.

SENSe Subsystem
The [SENSe[1]]|SENSe2:LIMit:CLEar Node

The [SENSe[1]]|SENSe2:LIMit:CLEar Node

This node contains the commands that are used to clear any limit failures.

The commands associated with this node are:

```
[SENSe[1]]|SENSe2:LIMit:CLEar:AUTO <Boolean>|ONCE  
[SENSe[1]]|SENSe2:LIMit:CLEar[:IMMediate]
```

[SENSe[1]]|SENSe2:LIMit:CLEar:AUTO <Boolean>|ONCE

This command is used to control when the FCO (fail counter) is cleared of any limit failures. The FCO is used to determine the results returned by the [SENSe[1]]|SENSe2:LIMit:FAIL? query.

If ON is specified, the FCO is set to 0 each time a measurement:

- is initiated using INITiate[:IMMediate].
- is initiated using INITiate:CONTinuous ON.
- is measured using MEASure?
- is read using READ?

If OFF is specified, the FCO is not cleared by the above commands.

If ONCE is specified, the FCO is cleared only after the first initialization then starts accumulating any limit failures.

Syntax

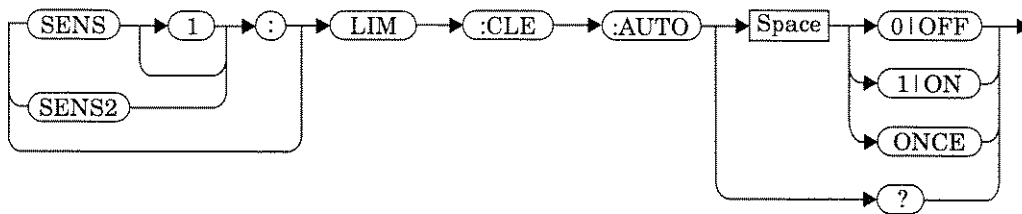

Example

SENS1:LIM:CLE:AUTO 1

This command switches on automatic clearing of the FCO for channel A.

Reset Condition

On reset, both channels are set to ON.

SENSe Subsystem

[SENSe[1]]|SENSe2:LIMit:CLEar:AUTO <Boolean>|ONCE

Query

```
[SENSe[1]]|SENSe2:LIMit:CLEar:AUTO?
```

The query command enters a 1 or 0 into the output buffer indicating whether limit failures are cleared automatically when a new measurement is initiated on the specified channel.

- 1 is entered into the output buffer when limit failures are cleared automatically when a new measurement is initiated.
- 0 is entered into the output buffer when limit failures are not cleared automatically when a new measurement is initiated.

In the case where limit failures are cleared once, when a query occurs a 1 is entered into the output buffer if no measurement is initiated. If a measurement is initiated then 0 is entered.

Query Example

```
SENS1:LIM:CLE:AUTO?
```

This command queries when the FCO is cleared for channel A.

[SENSe[1]]|SENSe2:LIMit:CLEar[:IMMEDIATE]

This command is used to immediately clear the FCO (fail counter) of any limit failures for the specified channel. The FCO is used to determine the results returned by the [SENSe[1]]|SENSe2:LIMit:FAIL? query.

Syntax

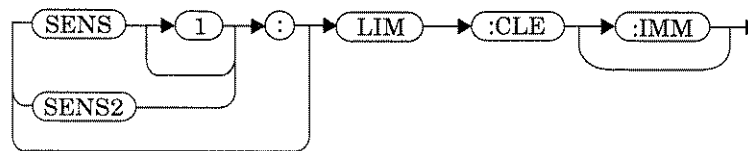

Example

SENS2 : LIM : CLE : IMM

This command clears the FCO for channel B.

SENSe Subsystem
[SENSe[1]]|SENSe2:LIMit:FAIL?

[SENSe[1]]|SENSe2:LIMit:FAIL?

This query enters a 1 or 0 into the output buffer indicating whether there have been any limit failures for the specified channel. A limit failure is defined as [SENSe[1]] | SENSe2:LIMit:FCO? being non-zero. The FCO (fail counter) can be zeroed using the [SENSe[1]] | SENSe2:LIMit:CLear command.

- 1 is returned when one or more limit failures have occurred.
- 0 is returned when no limit failures have occurred.

Syntax

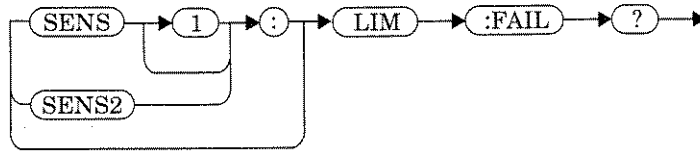

Example

SENS1:LIM:FAIL?

This command queries if there have been any limit failures on channel A.

Reset Condition

On reset, the buffer is set to zero for both channels.

[SENSE[1]]|SENSE2:LIMit:FCOut?

This query is used to return the total number of limit failures for the specified channel.

If the appropriate STATE commands are set to ON, each time a measurement is initiated on the specified channel and the measurement result is outside the limits, the counter is incremented by one.

If the measured value is equal to a limit, this is a limit pass.

The counter is reset to zero by any of the following commands:

- *RST
- [SENSE[1]]|SENSE2:LIMit:CLEar:IMMediate
- [SENSE[1]]|SENSE2:LIMit:CLEar:AUTO ON

When [SENSE[1]]|SENSE2:LIMit:CLEar:AUTO is set to ON, the counter is set to zero each time a measurement:

- is measured using MEASure?
- is read using READ?
- is initiated using:
 - INITiate[:IMMediate] or,
 - INITiate:CONTinuous ON.

When [SENSE[1]]|SENSE2:LIMit:CLEar:AUTO is set to ONCE, the counter is set to zero the first time a measurement:

- is measured using MEASure?
- is read using READ?
- is initiated using:
 - INITiate[:IMMediate] or,
 - INITiate:CONTinuous ON.

The maximum number of errors is $2^{16}-1$. If more than $2^{16}-1$ errors are detected the counter returns to zero.

SENSe Subsystem
[SENSe[1]]|SENSe2:LIMit:FCOunt?

Syntax

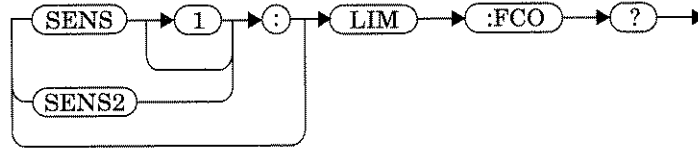

Example

SENS1:LIM:FCO?

This command queries the number of limit failures on channel A.

Reset Condition

On reset, the counter is set to zero on both channels.

[SENSe[1]]|SENSe2:LIMit:LOWer[:DATA] <numeric_value>

This command is used to enter a value for the lower test limit for the specified channel used in the [SENSe[1]]|SENSe2:LIMit:FAIL? test. The value is entered in dBm. When the measured power is less than the value specified in [SENSe[1]]|SENSe2:LIMit:LOWer:DATA, [SENSe[1]]|SENSe2:LIMit:FAIL? reports a fail. When the measured power is greater than or equal to the limit, a fail is not reported.

Syntax

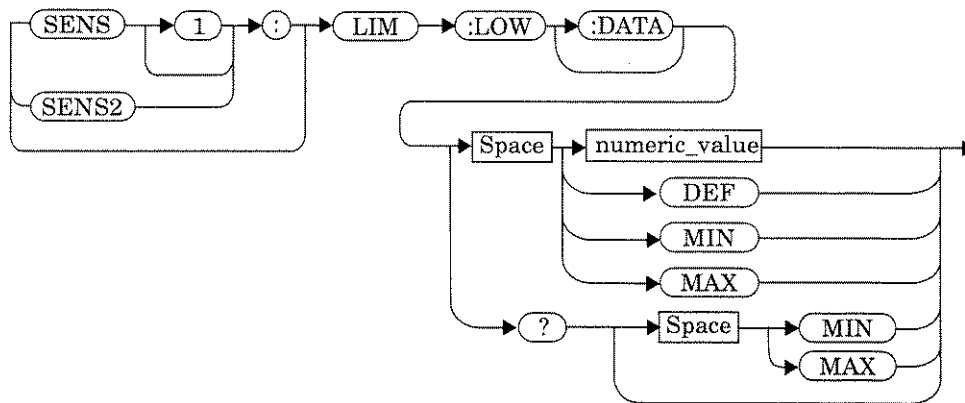

Parameters

Item	Description/Default	Range of Values
numeric_value	A numeric value. The default value, DEF, is -90.00 dBm. The value for MIN is -150 dBm. The value for MAX is +230 dBm.	-150 to +230 dBm DEF MIN MAX

Example

SENS2:LIM:LOW:DATA MIN

This command enters a lower limit for channel B of -150 dBm.

SENSe Subsystem
[SENSe[1]]|SENSe2:LIMit:LOWer[:DATA] <numeric_value>

Reset Condition

On reset, both channels are set to -90.00 dBm (DEF).

Query

[SENSe[1]]|SENSe2:LIMit:LOWer[:DATA]? [MIN|MAX]

The query returns the current setting of the lower limit or the values associated with MIN and MAX for the specified channel.

Query Example

SENSe2:LIM:LOW:DATA?

This command queries the lower limit set for channel B.

[SENSe[1]]|SENSe2:LIMit:STATe <Boolean>

This command is used to enable and disable the test limits for the specified channel.

Syntax

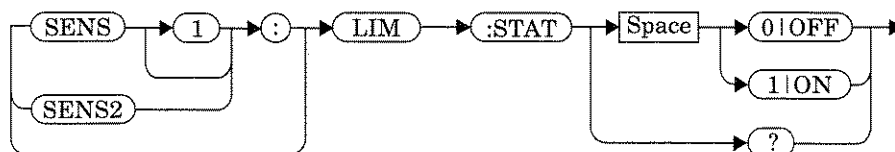

Example

`SENS2:LIM:STAT 1`

This command enables the limit checking function for channel B.

Reset Condition

On reset, limit checking is disabled.

Query

`[SENSe[1]]|SENSe2:LIMit:STATe?`

The query enters 1 or 0 into the output buffer indicating the status of the limits testing feature for the specified channel.

- 1 is returned when limits testing is enabled.
- 0 is returned when limits testing is disabled.

Query Example

`SENS1:LIM:STAT?`

This command queries whether the limit checking function for the channel A is on or off.

Error Message

If `[SENSe[1]]|SENSe2:LIMit:STATe` is set to ON while `[SENSe[1]]|SENSe2:SPEed` is set to 200, the error -221, "Settings Conflict" occurs.

SENSe Subsystem
 [SENSe[1]]|SENSe2:LIMit:UPPer[:DATA] <numeric_value>

[SENSe[1]]|SENSe2:LIMit:UPPer[:DATA] <numeric_value>

This command is used to enter a value for the upper test limit for the specified channel used in the [SENSe[1]]|SENSe2:LIMit:FAIL? test. The value is entered in dBm. When the measured power is greater than the value specified in [SENSe[1]]|SENSe2:LIMit:UPPer:DATA, [SENSe[1]]|SENSe2:LIMit:FAIL? reports a fail. When the measured power is less than or equal to the limit, a fail is not reported.

Syntax

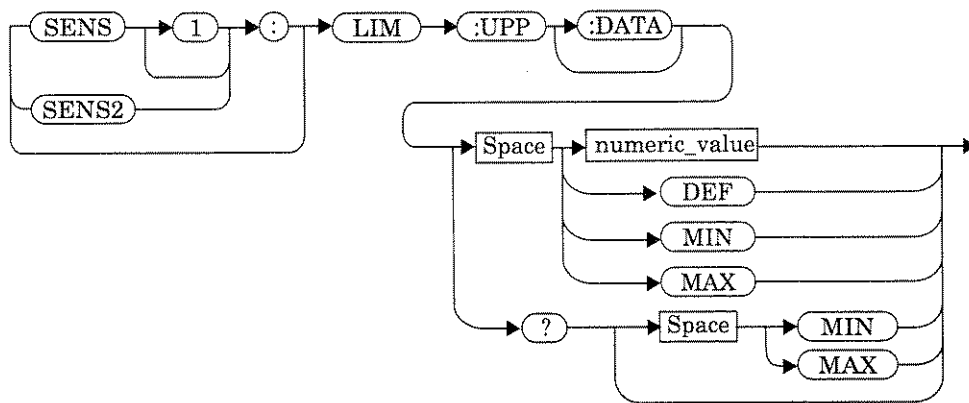

Parameters

Item	Description/Default	Range of Values
numeric_value	A numeric value. The default value, DEF, is +90.00 dBm. The value for MIN is -150 dBm. The value for MAX is +230 dBm.	-150 to +230 dBm DEF MIN MAX

Example

SENS2:LIM:UPP:DATA -20DBM *This command enters an upper limit of -20 dBm for channel B.*

Reset Condition

On reset, both channels are set to +90.00 dBm (DEF).

SENSE Subsystem
[SENSe[1]]|SENSe2:LIMit:UPPer[:DATA] <numeric_value>

Query

[SENSe[1]]|SENSe2:LIMit:UPPer[:DATA]? [MIN|MAX]

The query returns the current setting of the upper limit or the values associated with MIN and MAX for the specified channel.

Query Example

SENS2:LIM:UPP:DATA?

This command queries the setting of the upper limit for channel B.

SENSe Subsystem

[SENSe[1]]|SENSe2:POWer:AC:RANGe <numeric_value>

[SENSe[1]]|SENSe2:POWer:AC:RANGe <numeric_value>

This command is used with the HP E-series power sensors to select one of two power ranges.

- If 0 is selected, the power sensor's lower range is selected.
- If 1 is selected, the power sensor's upper range is selected.

Setting a range with this command automatically switches

[SENSe[1]]|SENSe2:POWer:AC:RANGe:AUTO to OFF.

Syntax

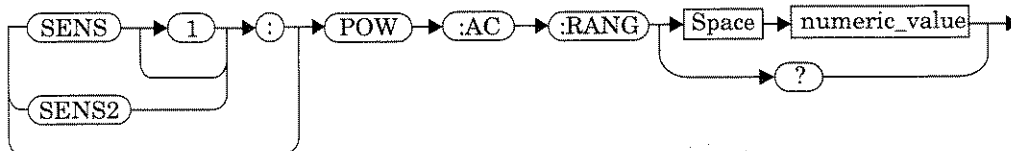

Example

```
POW:AC:RANG 0
```

This command sets the power sensor to its lower range.

Reset Condition

On reset, the upper range is selected.

Query

```
[SENSe[1]]|SENSe2:POWer:AC:RANGe?
```

The query enters a 1 or 0 into the output buffer indicating the status of the power sensor's range.

- 1 is returned when the upper range is selected.
- 0 is returned when the lower range is selected.

Query Example

```
POW:AC:RANG?
```

This command queries the current setting of the power sensor range.

Error Message

This command is used with the HP E-series power sensors. If one is not connected the error -241, "Hardware missing" occurs.

[SENSe[1]]|SENSe2:POWer:AC:RANGe:AUTO <Boolean>

This command is used with the HP E-series power sensors to enable and disable autoranging. When autoranging is ON, the power meter selects the best measuring range for the measurement. When autoranging is set to OFF, the power meter remains in the currently set range.

The [SENSe[1]]|SENSe2:POWer:AC:RANGe command disables autoranging.

If INITiate:CONTinuous is set to ON and TRIGger:SOURce is set to IMMEDIATE, the range will track the input power if [SENSe[1]]|SENSe2:POWer:AC:RANGe:AUTO is ON.

If the power meter is not making measurements then autoranging only occurs when the power meter is triggered.

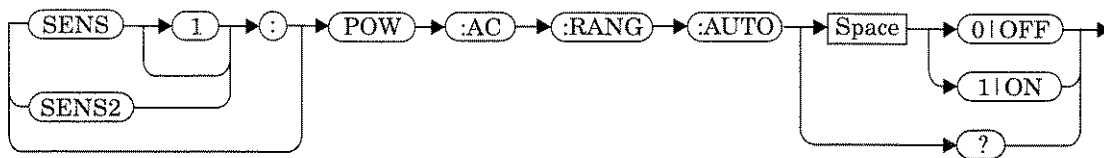
Syntax**Example**

```
POW:AC:RANG:AUTO 0
```

This command disables autoranging.

Reset Condition

On reset, autoranging is enabled.

Query

```
[SENSe[1]]|SENSe2:POWer:AC:RANGe:AUTO?
```

The query enters a 1 or 0 into the output buffer indicating the status of autoranging.

- 1 is returned when autoranging is enabled.
- 0 is returned when autoranging is disabled.

SENSe Subsystem
[SENSe[1]]|SENSe2:POWer:AC:RANGe:AUTO <Boolean>

Query Example

POW:AC:RANG:AUTO?

*This command queries whether
auto ranging is on or off.*

Error Message

If this command is set to OFF when there is not an HP E-series power sensor connected, the error, -241, "Hardware missing" occurs.

[SENSe[1]]|SENSe2:SPEEd <numeric_value>

This command is used to select the measurement speed on the selected channel. The speeds available are 20, 40 and 200 readings/second. Refer to “Getting the Best Speed Performance”, on page 1-54 for further information.

When a channel is set to 200 readings/second the following couplings occur.

Command	Status
[SENSe[1]] SENSe2:AVERAge:STATe	OFF ¹
[SENSe[1]] SENSe2:LIMit:STATe	OFF ¹
[SENSe[1]] SENSe2:CORRection:DCYClE:STATe	OFF ¹
[SENSe[1]] SENSe2:CORRection:GAIN2:STATe	OFF ¹
CALCulate[1 2]:GAIN:STATe	OFF ²
CALCulate[1 2]:RELative:STATe	OFF ²
CALCulate1:MATH:EXPRession	“(SENSe1)”
CALCulate2:MATH:EXPRession	“(SENSe2)”

1. This change only occurs on the channel specified in the SENSe:SPEEd command. When the specified channel is changed from 200 readings/second to either 20 or 40 readings/second the settings that were in place when 200 readings/second mode was entered are restored.
2. This change occurs when either channel is set to 200 readings/second. When both channels are changed from 200 readings/second to either 20 or 40 readings/second the settings that were in place when 200 readings/second mode was entered are restored.

Syntax

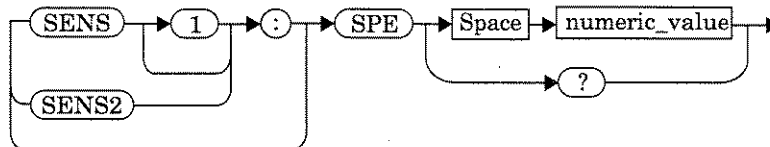

SENSe Subsystem
[SENSe[1]]|SENSe2:SPEed <numeric_value>

Parameters

Item	Description/Default	Range of Values
numeric_value	A numeric value for the measurement speed. The default is 20.	20 40 200

Example

SPE 40

This command sets the channel A speed to 40 readings / second.

Reset Condition

On reset, the speed is set to 20 readings/second.

Query

{SENSe[1]}|SENSe2:SPEed?

The query returns the current speed setting, either 20, 40 or 200.

Query Example

SPE?

This command queries the current speed setting for channel A.

Error Message

If <speed> is not 20, 40 or 200, error -224, "Illegal parameter value" occurs.

If an HP E-series power sensor is not connected and the <numeric_value> is set to 200 readings/second the error -241, "Hardware missing" occurs.

10

STATUS Subsystem

STATUS Subsystem
STATUS Subsystem

STATUS Subsystem

The STATUS command subsystem enables you to examine the status of the power meter by monitoring the “Device Status Register”, “Operation Status Register” and the “Questionable Status Register”.

Table 10-1 summarizes the effects of various commands and events on the status data structures in the power meter.

Table 10-1: Status Data Structure

Status Data Structure	*RST	*CLS	Power On	STATUS: PRESet
SCPI Transition Filters	none	none	preset	preset
SCPI Enable Registers	none	none	preset	preset
SCPI Event Registers	none	clear	clear	none
SCPI Error/Event Queue enable	none	none	preset	preset
SCPI Error/Event Queue	none	clear	clear	none
IEEE488.2 Registers ESE SRE	none	none	clear	none
IEEE488.2 Registers SESR STB	none	clear	clear	none

As the status reporting commands are orthogonal, the same commands apply to all the registers. The registers are:

- STATUS:DEVICE (page 10-8)
- STATUS:OPERation (page 10-11)
- STATUS:OPERation:CALibrating[:SUMMARY] (page 10-12)
- STATUS:OPERation:LLFail[:SUMMARY] (page 10-13)
- STATUS:OPERation:MEASuring[:SUMMARY] (page 10-14)
- STATUS:OPERation:SENSE[:SUMMARY] (page 10-15)
- STATUS:OPERation:TRIGger[:SUMMARY] (page 10-16)
- STATUS:OPERation:ULFail[:SUMMARY] (page 10-17)
- STATUS:QUESTionable (page 10-20)
- STATUS:QUESTionable:CALibration[:SUMMARY] (page 10-21)
- STATUS:QUESTionable:POWER[:SUMMARY] (page 10-22)

The following five commands operate on each of these registers. However, to avoid duplication they are only listed once.

Keyword	Parameter Form	Notes	Page
:CONDition?		[query only]	page 10-4
:ENABle	<NRf> <non-decimal numeric>		page 10-5
[:EVENT?]		[query only]	page 10-4
:NTRansition	<NRf> <non-decimal numeric>		page 10-6
:PTRansition	<NRf> <non-decimal numeric>		page 10-7

For example, to use the :CONDition?command on the STATUS:DEVICE register, use:

```
STATUS:DEVICE:CONDition?
```

To use the :NTRansition command on the STATUS:OPERation:SENSE[:SUMMARY] register, use:

```
STATUS:OPERation:SENSE[:SUMMARY]:NTRansition
```

Status Register Set Commands

The following descriptions detail the five commands which can be applied to all the SCPI registers. These commands should be prefixed with the node or nodes that represent the SCPI Register Set you require to control. For example, to use the :ENABLE command on the STATUS:QUESTIONABLE register use STATUS:QUESTIONABLE:ENABLE.

The five Status Register Set commands are:

```
:CONDition?  
:ENABle <NRf>|<non-decimal numeric>  
[:EVENT?]  
:NTRansition <NRf>|<non-decimal numeric>  
:PTRansition <NRf>|<non-decimal numeric>
```

:CONDition?

This query returns a 16 bit decimal-weighted number representing the bits set in the Condition Register of the SCPI Register Set you require to control. The format of the return is <NR1> in the range of 0 to 32767 ($2^{15}-1$). The contents of the Condition Register remain unchanged after it is read.

Syntax

--> :COND → ? →

[:EVENT]?

This query returns a 16 bit decimal-weighted number representing the bits set in the Event Register of the SCPI Register Set you require to control. The format of the return is <NR1> in the range of 0 to 32767 ($2^{15}-1$). This query clears all bits in the register to 0.

Syntax

→ :EVEN → ? →

:ENABle <NRf>|<non-decimal numeric>

This command is used to set the Enable Register of the particular SCPI Register Set you require to control. The parameter value, when rounded to an integer and expressed in base 2 has its first 15 bits written into the Enable Register of the SCPI Register Set concerned. The last bit (bit 15) is always set to 0.

Syntax

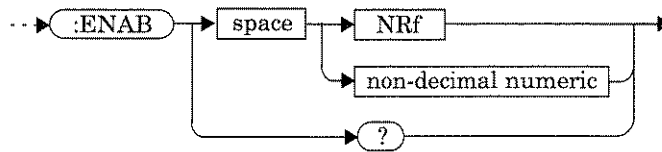

Parameters

Type	Description	Range of Values
NRf	The value used to set the Enable Register.	0 to 2 ¹⁶ -1
non-decimal numeric		

Query

:ENABle?

The query returns a 15 bit decimal-weighted number representing the contents of the Enable Register of the SCPI Register Set being queried. The format of the return is <NR1> in the range of 0 to 32767 (2¹⁵-1).

STATUS Subsystem
Status Register Set Commands

:NTRansition <NRf>|<non-decimal numeric>

This command is used to set the Negative Transition Register of the SCPI Register Set you require to control. The parameter value, when rounded to an integer and expressed in base 2 has it's first 15 bits written into the Negative Transition Register of the SCPI Register Set concerned. The last bit (bit 15) is always set to 0.

Refer to "Status Reporting", on page 1-59 for a general description of the status register model.

Syntax

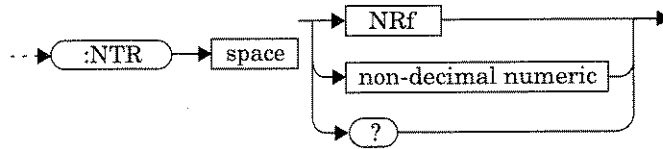

Parameters

Type	Description	Range of Values
NRf	The value used to set the NTR Register.	0 to $2^{16}-1$
non-decimal numeric		

Query

:NTRansition?

The query returns a 15 bit decimal-weighted number representing the contents of the Negative Transition Register of the SCPI register set being queried. The format of the return is <NR1> in the range of 0 to 32767 ($2^{15}-1$).

:PTRansition <NRf>|<non-decimal numeric>

This command is used to set the Positive Transition Register of the SCPI Register Set you require to control. The first 15 bits of the input parameter are written into the Positive Transition Register of the SCPI Register Set concerned. The last bit (bit 15) is always set to 0.

Refer to “Status Reporting”, on page 1-59 for a general description of the status register model.

Syntax

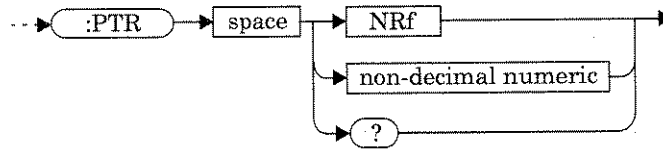

Parameters

Type	Description	Range of Values
NRf	The value used to set the PTR Register.	0 to 2 ¹⁶ -1
non-decimal numeric		

Query

:PTRansition?

The query returns a 15 bit decimal-weighted number representing the contents of the Positive Transition Register of the SCPI register set being queried. The format of the return is <NR1> in the range of 0 to 32767 (2¹⁵-1).

Device Status Register Sets

The following registers contain information which give device status information. The contents of the individual registers of these register sets may be accessed by appending the commands listed in "Status Register Set Commands".

The following command descriptions detail the SCPI register you require to control but do not detail the Register Set commands.

The one Device Status Register Set is:

STATus:DEVIce:

The following bits in these registers are used by the power meter:

Bit Number	Decimal Weight	Definition
0	-	Not used
1	2	Channel A sensor connected
2	4	Channel B sensor connected (HP EPM-442A only)
3	8	Channel A sensor error
4	16	Channel B sensor error (HP EPM-442A only)
5	32	Channel A sensor Front/Rear
6	64	Channel B sensor Front/Rear (HP EPM-442A only)
7-15	-	Not used
14	16384	Front Panel key press
15	-	Bit 15 always 0

The Channel A and B sensor connected bits (bits 1 and 2), when queried with the `STATUS:DEVICE:CONDITION?` query are set to:

- 1, when a power sensor is connected.
- 0, when no power sensor is connected.

The Channel A and B sensor connected bits (bits 1 and 2), when queried with the `STATUS:DEVICE:EVENT?` query indicate whether a power sensor has been connected or disconnected depending on the state of the corresponding bits of `STATUS:DEVICE:NTRANSITION` and `STATUS:DEVICE:PTRANSITION`. If the corresponding bit in:

- `STATUS:DEVICE:NTRANSITION` is 1, then `STATUS:DEVICE:EVENT?` is set when a power sensor is disconnected. Note, querying `STATUS:DEVICE:EVENT?` clears the `STATUS:DEVICE:EVENT?` register.
- `STATUS:DEVICE:PTRANSITION` is 1, then `STATUS:DEVICE:EVENT?` is set when a power sensor is connected. Note, querying `STATUS:DEVICE:EVENT?` clears the `STATUS:DEVICE:EVENT?` register.

The Channel A and B sensor error bits (3 and 4) are set to:

- 1, if the HP E-series power sensor EEPROM has failed or if there are power sensors connected to both the rear and front panel connectors.
- 0, for every other condition.

The Channel A and B sensor Front/Rear bits (bits 5 and 6) are set to:

- 1, if the power sensor is connected to the rear panel.
- 0, if the power sensor is connected to the front panel.

The Front Panel key press bit (bit 14), when queried with the `STATUS:DEVICE:EVENT?` query indicates whether any front panel keys have been pressed since power up or since you last queried the device status register. Note, this bit ignores the `:NTRANSITION`, and `:PTRANSITION` registers, and a `:CONDITION?` query always returns a 0.

Operation Register Sets

The following registers contain information which is part of the power meters normal operation. The contents of the individual registers of these register sets may be accessed by appending the commands listed in "Status Register Set Commands".

The following command descriptions detail the SCPI register you require to control but do not detail the Register Set commands.

The seven Operation Register Sets are:

```
STATUS:OPERation  
STATUS:OPERation:CALibrating[:SUMMARY]  
STATUS:OPERation:LLFail[:SUMMARY]  
STATUS:OPERation:MEASuring[:SUMMARY]  
STATUS:OPERation:SENSe[:SUMMARY]  
STATUS:OPERation:TRIGger[:SUMMARY]  
STATUS:OPERation:ULFail[:SUMMARY]
```

STATus:OPERation

The operation status register set contains conditions which are a part of the operation of the power meter as a whole.

The following bits in these registers are used by the power meter:

Bit Number	Decimal Weight	Definition
0	1	CALibrating Summary
1 - 3	-	Not used
4	16	MEASuring Summary
5	32	Waiting for TRIGger Summary
6 - 9	-	Not used
10	1024	SENSE Summary
11	2048	Lower Limit Fail Summary
12	4096	Upper Limit Fail Summary
13 to 15	-	Not used (bit 15 always 0)

These bits are set and cleared under the conditions shown on page 1-74.

Syntax

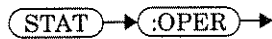

Status Subsystem
STATus:OPERation:CALibrating[:SUMM]ary

STATus:OPERation:CALibrating[:SUMM]ary

The operation status calibrating summary register set contains information on the calibrating status of the power meter.

The following bits in these registers are used by the power meter:

Bit Number	Decimal Weight	Definition
0	-	Not used
1	2	Channel A CALibrating Status
2	4	Channel B CALibrating Status (HP EPM-442A only)
3-15	-	Not used

These bits are set at the beginning of zeroing (CALibration:ZERO:AUTO ONCE) and at the beginning of calibration (CALibration:AUTO ONCE). Also for the compound command/query CALibration[:ALL]?, this bit is set at the beginning of the calibration sequence.

These bits are cleared at the end of zeroing or calibration.

Syntax

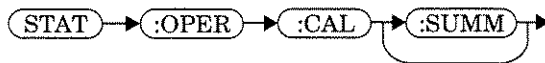

STATus:OPERation:LLFail[:SUMMARY]

The operation status lower limit fail summary register set contains information on the lower limit fail status of the power meter.

The following bits in these registers are used by the power meter:

Bit Number	Decimal Weight	Definition
0	-	Not used
1	2	Channel A LLFail Status
2	4	Channel B LLFail Status (HP EPM-442A only)
3-15	-	Not used

These bits are set if a power measurement is made and the lower limit test fails.

These bits are cleared if a power measurement is made and the test is enabled and passes.

Syntax

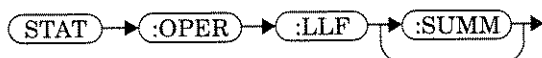

STATus Subsystem
STATus:OPERation:MEASuring[:SUMMary]

STATus:OPERation:MEASuring[:SUMMary]

The operation status measuring summary register set contains information on the measuring status of the power meter.

The following bits in these registers are used by the power meter:

Bit Number	Decimal Weight	Definition
0	-	Not used
1	2	Channel A MEASuring Status
2	4	Channel B MEASuring Status (HP EPM-442A only)
3-15	-	Not used

These bits are set when the power meter is taking a measurement.

These bits are cleared when the measurement is finished.

Syntax



STATus:OPERation:SENSe[:SUMM]ary]

The operation status sense summary register set contains information on the status of the power sensors.

The following bits in these registers are used by the power meter:

Bit Number	Decimal Weight	Definition
0	-	Not used
1	2	Channel A SENSE Status
2	4	Channel B SENSE Status (HP EPM-442A only)
3-15	-	Not used

These bits are set when the power meter is reading data from the HP E-series power sensor EEPROM.

These bits are cleared when the power meter is not reading data from the HP E-series power sensor EEPROM.

Syntax

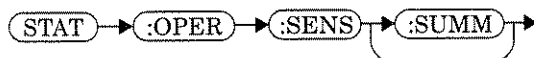

STATus Subsystem
STATus:OPERation:TRIGger[:SUMMary]

STATus:OPERation:TRIGger[:SUMMary]

The operation status trigger summary register set contains information on the trigger status of the power meter.

The following bits in these registers are used by the power meter:

Bit Number	Decimal Weight	Definition
0	-	Not used
1	2	Channel A TRIGger Status
2	4	Channel B TRIGger Status (HP EPM-442A only)
3-15	-	Not used

These bits are set when the power meter enters the “wait for trigger” state. Refer to Figure 1-7, “Trigger System,” on page 1-51.

These bits are cleared when the power meter enters the “idle” state. Refer to Figure 1-7, “Trigger System,” on page 1-51.

Syntax

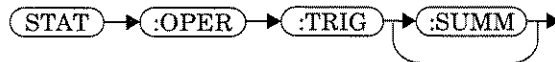

STATus:OPERation:ULFail[:SUMMARY]

The operation status upper limit fail summary register set contains information on the upper limit fail status of the power meter.

The following bits in these registers are used by the power meter:

Bit Number	Decimal Weight	Definition
0	-	Not used
1	2	Channel A ULFail Status
2	4	Channel B ULFail Status (HP EPM-442A only)
3-15	-	Not used

These bits are set if a power measurement is made and the upper limit test fails.

These bits are cleared if a power measurement is made and the test is enabled and passes.

Syntax

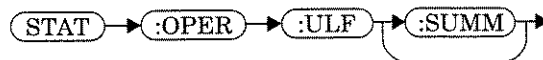

STATus Subsystem
STATus:PRESet

STATus:PRESet

PRESet sets a number of the status registers to their preset values as shown below - all other registers are unaffected. Bit 15 is always 0.

Register	Filter/Enable	PRESet Value
OPERational	ENABLE	all zeros
	PTR	all ones
	NTR	all zeros
QUEStionable	ENABLE	all zeros
	PTR	all ones
	NTR	all zeros
All Others	ENABLE	all ones
	PTR	all ones
	NTR	all zeros

Syntax

STAT → :PRES →

Questionable Register Sets

The Questionable Register Sets contain information which gives an indication of the quality of the data produced by the power meter. The contents of the individual registers in these register sets may be accessed by appending the commands listed in "Status Register Set Commands".

The following command descriptions detail the SCPI register you require to control but do not detail the Register Set commands.

The three Questionable Register Sets are:

```
STATUS:QUESTIONable  
STATUS:QUESTIONable:CALibration[:SUMMARY]  
STATUS:QUESTIONable:POWER[:SUMMARY]
```

STATUS Subsystem
STATUS:QUESTIONable

STATUS:QUESTIONable

The questionable register set contains bits which give an indication of the quality of various aspects of signals processed by the power meter as a whole.

The following bits in these registers are used by the power meter:

Bit Number	Decimal Weight	Definition
0 to 2	-	Not used
3	8	POWER Summary
4 to 7	-	Not used
8	256	CALibration Summary
9	512	Power On Self Test
10 to 15	-	Not Used (bit 15 always 0)

Bit 3 is set by the logical OR outputs of the
STATUS:QUESTIONable:POWER:SUMMARY register set.

Bit 8 is set by the logical OR outputs of the
STATUS:QUESTIONable:CALibration:SUMMARY register set.

Bit 9 is set if power-on self-test fails, and cleared if it passes.

Syntax



STATus:QUESTionable:CALibration[:SUMM]ary]

The questionable calibration summary register set contains bits which give an indication of the quality of the data produced by the power meter due to its calibration status.

The following bits in these registers are used by the power meter:

Bit Number	Decimal Weight	Definition
0	-	Not used
1	2	Summary of Channel A CALibration
2	4	Summary of Channel B CALibration (HP EPM-442A only)
3-15	-	Not used

These bits are set by the following:

- Error -231, "Data questionable; CH<A|B>:ZERO ERROR"
- Error -231, "Data questionable; CAL ERROR"
- Error -231, "Data questionable; CAL ERROR ChA"
- Error -231, "Data questionable; CAL ERROR ChB"

These bits are cleared when any of the three commands listed above succeed and no errors are placed on the error queue.

Syntax

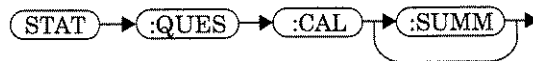

STATUS:QUESTIONABLE:POWER[:SUMMARY]

The questionable power summary register set contain bits which give an indication of the quality of the power data being acquired by the power meter.

The following bits in these registers shall be used by the power meter:

Bit Number	Decimal Weight	Definition
0	-	Not used
1	2	Channel A Power
2	4	Channel B Power (HP EPM-442A only)
3	8	Upper Window Power
4	16	Lower Window Power
5	32	Channel A Please Zero
6	64	Channel B Please Zero (HP EPM-442A only)

Bit 1 is set when any of the following errors occur:

- Error -230, "Data corrupt or stale"
- Error -231, "Data questionable;Input Overload" (HP EPM-441A only)
- Error -231, "Data questionable;Input Overload ChA" (HP EPM-442A only)

Bit 2 is set when any of the following errors occur:

- Error -230, "Data corrupt or stale"
- Error -231, "Data questionable;Input Overload ChB" (HP EPM-442A only)

Bits 3 is set when the following error occurs:

- Error -231, "Data questionable;Upper window log error"

Bit 4 is set when the following error occurs:

- Error -231, "Data questionable;Lower window log error"

Bit 5 is set when the following condition occurs:

- Channel A requires zeroing

Bit 6 is set when the following condition occurs (HP EPM-442A only):

- Channel B requires zeroing

These bits are cleared when no errors or events are detected by the power meter during a measurement covering the causes given for it to set.

Syntax

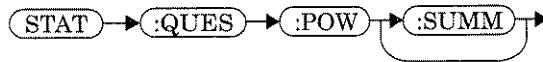

STATus Subsystem
STATus:QUEStionable:POWer[:SUMMary]

11

SYSTEM Subsystem

SYSTEM Subsystem
SYSTEM Subsystem

SYSTEM Subsystem

The **SYSTEM** command subsystem is used to return error numbers and messages from the power meter, preset the power meter, set the GPIB address, set the command language and query the SCPI version.

Keyword	Parameter Form	Notes	Page
SYSTEM			
:COMMunicate			
:GPIB			
[:SELP]			
:ADDRESS	<numeric_value>		page 11-3
:ERRor?		[query only]	page 11-4
:LANGUage	<character_data>		page 11-5
:PRESet		[event; no query]	page 11-6
:VERSion?		[query only]	page 11-9

SYSTem:COMMunicate:GPIB[:SELF]:ADDRess <numeric_value>

This command sets the GPIB address of the power meter.

Syntax

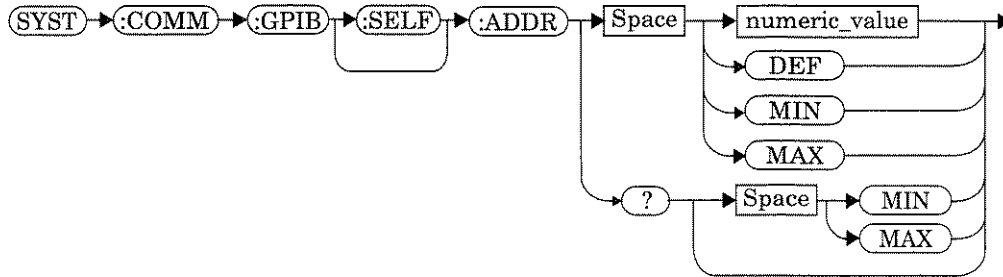

Parameters

Item	Description/Default	Range of Values
numeric_value	A numeric value for the address. The default value, DEF, is 13. The value for MIN is 0. The value for MAX is 30.	0 to 30 DEF MIN MAX

Example

SYST:COMM:GPIB:ADDR 13 *This command sets the GPIB address to 13.*

Query

SYSTem:COMMunicate:GPIB[:SELF]:ADDRess? MIN|MAX

The query returns the current setting of the GPIB address or the values associated with MIN and MAX.

Query Example

SYST:COMM:GPIB:ADDR? *This command queries the setting of the GPIB address.*

SYSTem:ERRor?

This query returns error numbers and messages from the power meter's error queue. When an error is generated by the power meter, it stores an error number and corresponding message in the error queue. One error is removed from the error queue each time the `SYSTem:ERRor?` command is executed. The errors are cleared in the order of first-in first-out, that is, the oldest errors are cleared first. To clear all the errors from the error queue, execute the `*CLS` command. When the error queue is empty, subsequent `SYSTem:ERRor?` queries return a +0, "No error" message. The error queue has a maximum capacity of 30 errors.

For further information on individual error messages refer to the *User's Guide*.

Syntax

`SYST` → `:ERR` → `?`

Example

`SYST:ERR?`

This command queries the oldest error message stored in the power meter's error queue.

Reset Condition

On reset, the error queue is unaffected.

Error Messages

The error queue has a maximum capacity of 30 errors. If the queue overflows, the last error is replaced with -350, "Queue overflow". No additional errors are accepted by the queue until space becomes available.

SYSTEM:LANGUage <character_data>

This command is used to change the remote programming language accepted by the power meter from SCPI to the HP 437B programming language. To return to using the SCPI programming language when in the HP 437B mode use the `SYST:LANG SCPI` command. After sending the command to change language wait 100 ms before sending any other commands. When changing between languages the power meter is placed into local mode. It is recommended that the instrument is preset following a language switch.

Syntax

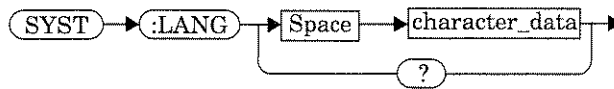

Parameters

Item	Description/Default	Range of Values
character_data	Character data containing the programming language.	HP437B SCPI

Example

`SYST:LANG HP437B`

This command sets the power meter to perform using the HP 437B programming language.

Query

`SYSTEM:LANGUage?`

The query returns the current setting of the remote programming language.

Query Example

`SYST:LANG?`

This command queries the setting of the remote programming language.

SYSTem Subsystem
SYSTem:PRESet

SYSTem:PRESet

This command is used to preset the power meter. The result of this command is similar to the *RST command. Refer to Table 11-1 for more information about the preset configuration.

Note All settings apply to both *RST and to SYSTem:PRESet unless stated otherwise.

Syntax



Example

SYST:PRESet

This command presets the power meter.

Table 11-1: Preset Settings

Command	Setting	Comments
CALC:GAIN[:MAGN]	0.000 dB	Display offset value
CALC:GAIN:STAT	OFF	Display offset disabled
CALC:MATH[:EXPR]	HP EPM-441A: Upper - channel A Lower - channel A HP EPM-442A Upper - channel A Lower - channel B	Math expression
CALC:REL[:MAGN]:AUTO	OFF	Reference value disabled
CALC:REL:STAT	OFF	Relative offset disabled
CAL:AUTO	OFF	Automatic calibration disabled
CAL:RCF	100.0%	Reference calibration factor
CAL:ZERO:AUTO	OFF	Automatic zeroing disabled
DISP:CONT	not affected	Display contrast
DISP:ENAB	ON	Display enabled

Command	Setting	Comments
DISP[:WIND[1 2]]:FORM	HP EPM-441A: Upper - digital Lower - analog HP EPM-442A Upper - digital Lower - digital	Display format
DISP[:WIND[1 2]]:MET:LOW	-70.000 dBm	Analog meter lower limit
DISP[:WIND[1 2]]:MET:UPP	+20.000 dBm	Analog meter upper limit
DISP[:WIND[1 2]]:RES	3	Window resolution
DISP[:WIND[1 2]]:SEL	upper window	Window selected
DISP[:WIND[1 2]][:STAT]	ON	Both windows enabled on display
FORM[:READ]:BORD	normal	Binary order
FORM[:READ][:DATA]	ascii	Data format
INIT:CONT	*RST: OFF SYS: PRES ON	Power Meter in "idle" state Power Meter in "wait-for-trigger" state
MEM:TABL:SEL	not affected	Active sensor calibration table
OUTP:ROSC	OFF	50 MHz reference disabled
SENS:AVER:COUN	4	Filter length
SENS:AVER:COUN:AUTO	ON	Auto-filtering enabled
SENS:AVER:STAT	ON	Averaging enabled
SENS:CORR:CSET:SEL	not affected	Selected sensor calibration table
SENS:CORR:CSET:STAT	not affected	Sensor calibration table disabled
SENS:CORR:DCYC GAIN3	1.000%	Duty cycle factor
SENS:CORR:DCYC GAIN3:STAT	OFF	Duty cycle correction disabled
SENS:CORR:CFAC GAIN1	100.0%	Calibration factor
SENS:CORR:GAIN2	0.000 dB	External gain
SENS:CORR:GAIN2:STAT	OFF	External gain correction disabled
SENS:CORR:LOSS2	0.000 dB	External gain
SENS:CORR:LOSS2:STAT	OFF	External loss correction disabled
SENS:FREQ	+50.000 MHz	Frequency setting
SENS:LIM:CLE:AUTO	ON	Clear limit data at INIT
SENS:LIM:FAIL	OFF	No failures
SENS:LIM:FCO	OFF	Limit failure count is zero
SENS:LIM:LOW[:DATA]	-90.000 dBm	Lower limit
SENS:LIM:STAT	OFF	Limits checking disabled
SENS:LIM:UPP[:DATA]	+90.000 dBm	Upper limit

SYSTem Subsystem
SYSTem:PRESet

Command	Setting	Comments
SENS:POW:AC:RANG	upper	Upper range selected
SENS:POW:AC:RANG:AUTO	ON	Auto-ranging selected
SENS:SPE	20 readings/second	Speed
SYST:GPIB:ADDR	not affected	Power meter address
SYST:ERR	not affected	Error messages
SYST:LANG	not affected	Programming language
SYST:VERS	not affected	SCPI version
TRIG:DEL:AUTO	ON	Delay after trigger enabled
TRIG:SOUR	IMM	Trigger source is immediate
UNIT:POW	dBm	Power units
UNIT:POW:RAT	dB	Ratio units

SYSTem:VERSion?

This query returns the version of SCPI used in the power meter. The response is in the form of XXXX.Y, where XXXX is the year and Y is the version number.

Syntax

SYST → :VERS → ?

Example

SYST:VERS?

This command queries which version of SCPI is used in the power meter.

SYSTem Subsystem
SYSTem:VERSIon?

12

TRIGger Subsystem

TRIGger Subsystem
TRIGger Subsystem

TRIGger Subsystem

The TRIGger subsystem is used to synchronize device actions with events.

The TRIGger subsystem includes the ABORT, INITiate and TRIGger commands. These are all at the root level in the command hierarchy but they are grouped here because of their close functional relationship.

Keyword	Parameter Form	Notes	Page
ABORT[1 2]		[no query]	page 12-3
INITiate[1 2]			
:CONTinuous	<Boolean>		page 12-5
[:IMMediate]		[no query]	page 12-5
TRIGger[1 2]			
:DELay			
:AUTO	<Boolean>		page 12-9
[:IMMediate]		[no query]	page 12-11
:SOURce	BUS IMMediate HOLD		page 12-12

Further information on triggering is detailed in “Triggering the Power Meter”, on page 1-49.

The numeric suffix of the TRIGger program mnemonic in the TRIGger commands refers to a channel, that is TRIGger1 and TRIGger2 represent channel A and channel B respectively. If you are using the single channel HP EPM-441A power meter the TRIGger2 commands are irrelevant and cause the error “Header suffix out of range.”

ABORt[1|2]

The **ABORt** command removes the specified channel from the “wait-for-trigger” state and places it in the “idle” state. It does not affect any other settings of the trigger system. When the **INITiate** command is sent, the trigger system responds as it did before **ABORt** was executed.

If **INITiate:CONTinuous** is ON, then after **ABORt** the specified channel immediately goes into the “wait-for-trigger” state.

Syntax

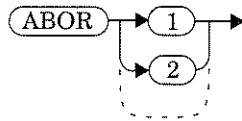

Example

ABOR

This command places channel A in the “idle” state.

INITiate Node

This command node allows you to place the power meter in the “wait-for-trigger” state.

The `INITiate` commands are overlapped, that is, the power meter can continue parsing and executing subsequent commands while initiated. Refer to IEEE 488.2, section 12 for further details. Note that the pending operation flag is set when the power meter moves out of the “idle” state and is cleared when it re-enters the “idle” state.

The commands associated with this node are:

```
INITiate[1|2] [:IMmediate]  
INITiate[1|2]:CONTinuous <Boolean>
```



INITiate[1|2]:CONTInuous <Boolean>

This command is used to set the power meter for either a single trigger cycle or continuous trigger cycles. A trigger cycle means that the power meter exits the “wait-for-trigger” state and starts a measurement. When entering local mode, INITiate:CONTInuous is set to ON.

If INITiate:CONTInuous is set to:

- OFF, the trigger system remains in the “idle” state until it is set to ON, or INITiate:IMMediate is received. Once this trigger cycle is complete the trigger system returns to the “idle” state.
- ON, the trigger system is initiated and exits the “idle” state. On completion of each trigger cycle, the trigger system immediately commences another trigger cycle without entering the “idle” state.

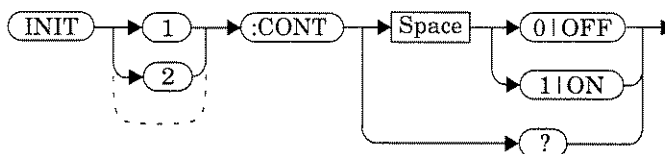
Syntax



Example

INIT2:CONT ON

This command places channel B in the “wait-for-trigger” state.

Reset Condition

On reset (*RST), this command is disabled.

On preset (SYSTEM:PRESet) and instrument power-up, this command is enabled.

Query

INITiate[1|2]:CONTInuous?

The query enters a 1 or 0 into the output buffer.

- 1 is returned when there is continuous triggering.
- 0 is returned when there is only a single trigger.

TRIGger Subsystem
INITiate[1|2]:CONTInuous <Boolean>

Query Example

INIT2:CONT?

This command queries whether channel B is set for single or continuous triggering.

INITiate[1|2][:IMMEDIATE]

This command is used to place the power meter in the “wait-for-trigger” state. When a trigger is received, the measurement is taken and the result placed in the power meter memory. If TRIGger:SOURCE is set to IMMEDIATE the measurement begins as soon as INITiate:IMMEDIATE is executed.

Use FETCh? to transfer a measurement from memory to the output buffer. Refer to “FETCh[1|2] Queries”, on page 2-21 for further details.

Syntax

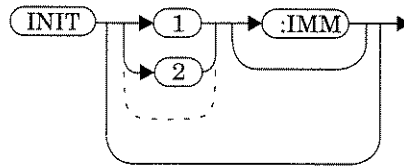

Example

```
INIT2:IMM
```

This command places channel B in the “wait-for-trigger” state.

Error Messages

If the power meter is not in the “idle” state or INITiate:CONTINUOUS is ON, error -213, “INIT ignored” occurs.

TRIGger Subsystem
TRIGger Node

TRIGger Node

This node controls the behavior of the trigger system.

The commands associated with this node are:

```
TRIGger[1|2]:DELay:AUTO <Boolean>  
TRIGger[1|2][:IMMediate]  
TRIGger[1|2]:SOURce BUS|IMMediate|HOLD
```

TRIGger[1|2]:DELay:AUTO <Boolean>

This command is used to determine whether or not there is a settling-time delay before a measurement is made.

When this command is set to:

- ON, the power meter inserts a settling-time delay before taking the requested measurement. This settling time allows the internal digital filter to be updated with new values to produce valid, accurate measurement results. The trigger with delay command allows settling time for the internal amplifiers and filters. It does not allow time for power sensor delay.

In cases of large power changes, the delay may not be sufficient for complete settling. Accurate readings can be assured by taking two successive measurements for comparison.

- OFF, the power meter makes the measurement immediately a trigger is received.

TRIGger [1|2] :DELay:AUTO is ignored if TRIGger [1|2] [:IMMediate] is set to ON.

Syntax

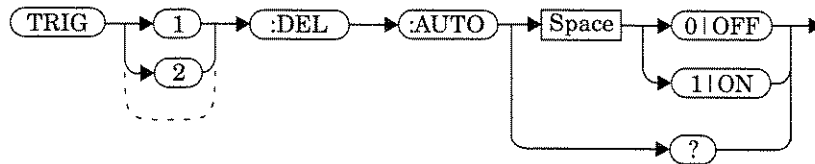

Example

```
TRIG:DEL:AUTO ON
```

This command enables a delay on channel A.

Reset Condition

On reset, TRIGger:DELay:AUTO is set to ON.

TRIGger Subsystem
TRIGger[1|2]:DELay:AUTO <Boolean>

Query

TRIGger:DELay:AUTO?

The query enters a 1 or 0 into the output buffer indicating the status of TRIGger:DELay:AUTO.

- 1 is returned when it is ON.
- 0 is returned when it is OFF.

TRIGger[1|2][:IMMEDIATE]

This command causes a trigger to occur immediately, provided the specified channel is in the “wait-for-trigger” state. When this command is executed, the measurement result is stored in the power meter’s memory. Use `FETCH?` to place the measurement result in the output buffer.

`TRIGger [1 | 2] : DELay : AUTO` is ignored if `TRIGger [1 | 2] [: IMMEDIATE]` is set to ON.

Syntax

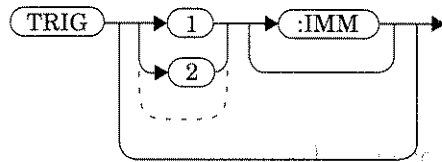

Example

TRIG

This command causes a channel A trigger to occur immediately.

Error Messages

If the power meter is not in the “wait-for-trigger” state, then `TRIGger : IMMEDIATE` causes error -211, “Trigger ignored”.

TRIGger[1|2]:SOURce BUS|IMMediate|HOLD

This command configures the trigger system to respond to the specified source. This command only selects the trigger source. You should use the INITiate command to place the power meter in the “wait-for-trigger” state. The following trigger sources are available:

- BUS
The trigger source is the group execute trigger <GET> bus command, a *TRG common command or the TRIGger:IMMediate SCPI command.
- HOLD
Triggering is suspended. The only way to trigger the power meter is to use the TRIGger:IMMediate.
- IMMediate
The trigger system is always true.
If INITiate:CONTinuous is ON the power meter is continuously triggering (free run mode).
If an INITiate:IMMediate command is sent a measurement is triggered then the power meter returns to the idle state.

On instrument power-up and when entering local mode, the trigger source is set to IMMediate.

Note

The MEASure, READ? and CONFIgure commands automatically set the trigger source to IMMediate.
The READ? or MEASure commands should not be used if the trigger source is BUS or HOLD.

Syntax

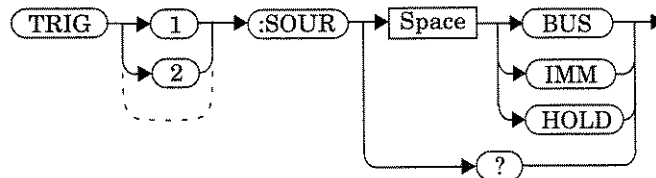

Example

TRIG:SOUR IMM

This command configures channel A for immediate triggering.

Reset Condition

On reset, the trigger source is set to IMMEDIATE.

Query

TRIGger:SOURce?

The query returns the current trigger source, either IMM, BUS or HOLD.

Query Example

TRIG:SOUR?

This command queries channel A's trigger source.

TRIGger Subsystem
TRIGger[12]:SOURce BUSIMMediateHOLD

13

UNIT Subsystem

UNIT Subsystem
UNIT Subsystem

UNIT Subsystem

The **UNIT** command subsystem is used to set the power meter measurement units to Watts and % (linear) or dBm and dB (logarithmic).

The numeric suffix of the **UNIT** program mnemonic in the **UNIT** commands refers to a window, that is **UNIT1** and **UNIT2** represent the upper and lower windows respectively.

The **UNIT:POWER** and **UNIT:POWER:RATio** commands are coupled, that is, if:

- **UNIT:POWER** is set to dBm then **UNIT:POWER:RATio** is dB.
- **UNIT:POWER** is set to W then **UNIT:POWER:RATio** is %.

Keyword	Parameter Form	Notes	Page
UNIT [1 2]			
:POWER	<amplitude unit>		page 13-3
:RATio	<ratio_unit>	[non-SCPI]	page 13-6

UNIT[1|2]:POWer <amplitude_unit>

This command is used to set the selected window's measurement units. For any command which accepts a numeric value in more than one unit and the power suffix is omitted then the units set by UNIT:POWer are used.

For the HP EPM-441A:

- UNIT1:POWer sets the power measurement units for the upper window. In addition, it also sets the power suffix for any SENSE1 command that requires but omits the power suffix.
- UNIT2:POWer sets the power measurement units for the lower window.

For the HP EPM-442A:

- UNIT1:POWer sets the power measurement units for the upper window. In addition, it also sets the power suffix for any SENSE1 command that requires but omits the power suffix.
- UNIT2:POWer sets the power measurement units for the lower window. In addition, it also sets the power suffix for any SENSE2 command that requires but omits the power suffix.

For ratio and relative power measurements, if UNIT:POWer is

- W, the measurement units are percentage.
- DBM, the measurement units are dB relative.

Syntax

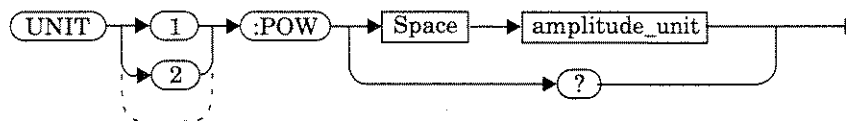

UNIT Subsystem
UNIT[1|2]:POW <amplitude_unit>

Parameters

Item	Description/Default	Range of Values
amplitude_unit	The measurement unit. The default unit is dBm.	W DBM

Example

```
UNIT1:POW DBM
```

This command sets the measurement units for the upper window and the default units for any relevant SENSE1 command to dBm.

Reset Condition

On reset, both channels are set to dBm.

Query

UNIT[1|2]:POWer?

The query returns the current setting of the measurement units.

Query Example

UNIT2:POW?

This command queries which measurement units are being used on the lower window. In addition, for the HP EPM-442A this command also queries the default units for any relevant SENSE2 command.

UNIT Subsystem
UNIT[1|2]:POWer:RATio <ratio_unit>

UNIT[1|2]:POWer:RATio <ratio_unit>

This command is used on the HP EPM-442A to set the default units used when inputting and outputting power ratio data.

- UNIT1:POWer:RATio sets the ratio measurement units for the upper window. In addition, it also sets the ratio suffix for any SENSE1 command that requires but omits the ratio suffix.
- UNIT2:POWer:RATio sets the ratio measurement units for the lower window. In addition, it also sets the ratio suffix for any SENSE2 command that requires but omits the ratio suffix.

Syntax

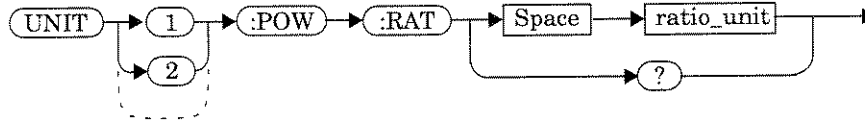

Parameters

Item	Description/Default	Range of Values
ratio_unit	The ratio measurement unit. The default unit is dB.	DB PCT

Example

```
UNIT1:POW:RAT DB
```

This command sets the ratio measurement units for the upper window and the default units for any relevant SENSE1 command to dB.

Reset Condition

On reset, the units are set to dB.

Query

UNIT[1|2]:POWer:RATio?

The query returns the current setting of the ratio measurement units.

Query Example

UNIT2:POW:RAT?

This command queries which ratio measurement units are being used on the lower window. It also queries the default units for any relevant SENSE2 command.

Error Message

If this command is used with an HP EPM-441A, error -113, "Undefined header" occurs.

UNIT Subsystem
UNIT[1|2]:POWER:RATio <ratio_unit>

IEEE488.2 Command Reference

IEEE-488 Compliance Information

This chapter contains information about the IEEE 488.2 Common (*) Commands that the power meter supports. It also describes the universal command statements which form the nucleus of HP-IB programming; they are understood by all instruments in the network. When combined with programming language codes, they provide all management and data communication instructions for the system.

The command descriptions are in alphabetical order.

IEEE-488.2 Common Commands

*CLS	Clear Status	page 14-7
*DDT	Define Device Trigger	page 14-8
*DDT?	Define Device Trigger	page 14-8
*ESE	Event Status Enable	page 14-10
*ESE?	Event Status Enable	page 14-10
*ESR?	Event Status Register	page 14-11
*IDN?	Identify	page 14-12
*OPC	Operation Complete	page 14-13
*OPC?	Operation Complete	page 14-13
*OPT?	Options	page 14-14
*RCL	Recall	page 14-15
*RST	Reset	page 14-16
*SAV	Save	page 14-17
*SRE	Service Request Enable	page 14-18
*SRE?	Service Request Enable	page 14-18
*STB?	Status Byte	page 14-20
*TRG	Trigger	page 14-22
*TST?	Test	page 14-23
*WAI	Wait	page 14-24

Universal Commands

DCL

The DCL (Device Clear) command causes all HP-IB instruments, or addressed instruments, to assume a cleared condition. The definition of device clear is unique for each instrument. For the power meter:

- All pending operations are halted, that is, *OPC? and *WAI.
- The parser (the software that interprets the programming codes) is reset and now expects to receive the first character of a programming code.
- The output buffer is cleared.

For further information refer to “Using Device Clear to Halt Measurements”, on page 1-81.

GET

The GET (Group Execute Trigger) command triggers all channels that are in the “wait-for-trigger” state.

Using the *DDT command may change the function of the GET command.

Error Message

If TRIGGER:SOURCE is not set to BUS then error -211, “Trigger ignored” occurs.

If the power meter is not in the “wait-for-trigger” state then error -211, “Trigger ignored” occurs.

GTL

The GTL (Go To Local) command is the complement to remote. It causes the power meter to return to local control with a fully enabled front panel. When reverting to local mode the power meter triggering is set to free run.

LLO

The LLO (Local Lock Out) command can be used to disable the front panel local key. With this key disabled, only the controller (or a hard reset by the line power switch) can restore local control.

PPC

When addressed to listen, the PPC (Parallel Poll Configure) command will cause the power meter to be configured according to the parallel poll enable secondary command which should follow this command.

PPD

Sending the PPC command followed by the PPD (Parallel Poll Disable) command will disable the power meter from responding to a parallel poll. This is effectively a selective disable.

Table 14-1: PPD Mapping

Bit	Weight	Meaning
0	1	Always 0
1	2	Always 0
2	4	Always 0
3	8	Always 0
4	16	Always 1
5	32	Always 1
6	64	Always 1
7	128	Always 0

PPE

Once the power meter has received a PPC command, the PPE (Parallel Poll Enable) secondary command configures the power meter to respond to a parallel poll on a particular data line with a particular level.

Table 14-2: PPE Mapping

Bit	Weight	Meaning
0	1	Bit positions for response: 000 (bit 0), 001 (bit 1), 010 (bit 2), 011 (bit 3), 100 (bit 4), 101 (bit 5), 110 (bit 6), 111 (bit 7)
1	2	
2	4	
3	8	Sense bit 0 - response bit is cleared during a parallel poll if requesting service 1 - response bit is set during a parallel poll if requesting service
4	16	Always 0
5	32	Always 1
6	64	Always 1
7	128	Always 0

PPU

The PPU (Parallel Poll Unconfigure) command disables the power meter from responding to a parallel poll. This is effectively a universal disable.

SDC

The SDC (Selected Device Clear) command causes all HP-IB instruments in the listen state, to assume a cleared condition. The definition of a selected device clear is unique for each instrument. For the power meter:

- All pending operations are halted, that is, *OPC? and *WAI.
- The parser (the software that interprets the programming codes) is reset and now expects to receive the first character of a programming code.
- The output buffer is cleared.

SPD

The SPD (Serial Poll Disable) command terminates the serial poll mode for the power meter and returns it to its normal talker state where device dependent data is returned rather than the status byte.

SPE

The SPE (Serial Poll Enable) command establishes the serial poll mode for the power meter. When the power meter is addressed to talk, a single eight bit status byte is returned (refer to "The Status Byte", on page 1-69 for further information).

***CLS**

The ***CLS** (Clear Status) command clears the status data structures. The SCPI registers (Questionable Status, Operation Status and all the other SCPI registers), the Standard Event Status Register, the Status Byte, and the Error/Event Queue are all cleared.

Syntax

***CLS** →

***DDT <arbitrary block program data>|<string program data>**

***DDT <arbitrary block program data>|<string program data>**

The *DDT (Define Device Trigger) command determines the power meter's response to a GET (Group Execute Trigger) message or *TRG common command. This command effectively turns GET and *TRG into queries, with the measured power being returned.

Syntax

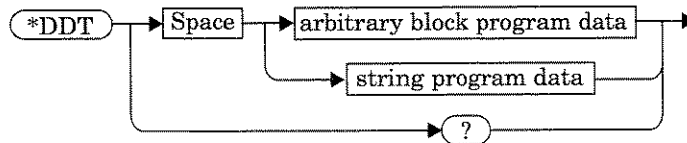

Parameters

Type	Description	Range of Values
arbitrary block program data	The command which is executed on a GET or *TRG.	#nN<action> ^{1,2}
string program data		"<action>" ¹

1. The <action> field of the parameter may contain:

- FETC?
- FETC1?
- FETC2? (HP EPM-442A only)
- *TRG
- TRIG1
- TRIG2 (HP EPM-442A only)

2. The first digit after the # indicates the number of following digits. The following digits indicate the length of the data.

Examples of <arbitrary block program data> parameters are:

- #15FETC? and #206FETCh?

Examples of <string program data> are:

- "FETCh1?", "FETCh?" and "TRIG1;FETC1"

Reset Condition

On reset, the <action> field of *DDT is set to *TRG.

DDT <arbitrary block program data>|<string program data>*Query*****DDT?**

The query returns the action which is performed on receipt of a GET or *TRG. This is returned as a <definite length arbitrary block response data> value which is in the form of #nN<action> as described on page 14-8.

Error Message

If an invalid parameter is received error -224, "Illegal parameter value" occurs.

***ESE <NRf>**

The *ESE (Event Status Enable) <NRf> command sets the Standard Event Status Enable Register. This register contains a mask value for the bits to be enabled in the Standard Event Status Register. A 1 in the Enable Register enables the corresponding bit in the Status Register, a 0 disables the bit. The parameter value, when rounded to an integer and expressed in base 2, represents the bit values of the Standard Event Status Enable Register. Table 14-3 shows the contents of this register.

Table 14-3: *ESE Mapping

Bit	Weight	Meaning
0	1	Operation Complete
1	2	Request Control (not used)
2	4	Query Error
3	8	Device Dependent Error
4	16	Execution Error
5	32	Command Error
6	64	Not used
7	128	Power On

Syntax

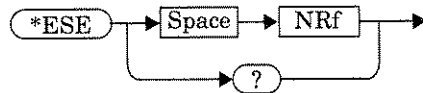

Parameters

Type	Description/Default	Range of Values
NRf	A value used to set the Standard Event Status Enable Register.	0 to 255

Query

*ESE?

The query returns the current contents of the Standard Event Status Enable Register. The format of the return is <NR1> in the range of 0 to 255.

***ESR?**

The *ESR? query returns the contents of the Standard Event Status Register then clears it. The format of the return is <NR1> in the range of 0 to 255. Table 14-4 shows the contents of this register.

Table 14-4: *ESR? Mapping

Bit	Weight	Meaning
0	1	Operation Complete
1	2	Request Control (not used)
2	4	Query Error
3	8	Device Dependent Error
4	16	Execution Error
5	32	Command Error
6	64	Not used
7	128	Power On

Syntax



*IDN?

The *IDN? query allows the power meter to identify itself. The string returned will be either:

HEWLETT-PACKARD,EPM-441A,<serial number>,A1.XX.YY

HEWLETT-PACKARD,EPM-442A,<serial number>,A2.XX.YY

HEWLETT-PACKARD,437B,,2.0

where:

- <serial number> uniquely identifies each power meter.
- A1.XX.YY and A2.XX.YY represents the firmware revision with XX and YY representing the major and minor revisions respectively.

Syntax



***OPC**

The *OPC (Operation Complete) command causes the power meter to set the operation complete bit in the Standard Event Status Register when all pending device operations have completed.

Syntax

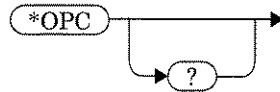

Query

*OPC?

The query places an ASCII 1 in the output queue when all pending device operations have completed.

***OPT?**

The *OPT? query reports the options installed in the power meter and returns:

" " empty string for a standard instrument

"002" for an option 002 instrument

"003" for an option 003 instrument

Syntax

*OPT → ? →

***RCL <NRf>**

The ***RCL <NRf>** (ReCaLl) command restores the state of the power meter from the specified save/recall register. An instrument setup must have been stored previously in the specified register.

Syntax

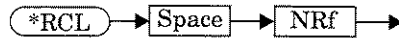

Parameters

Type	Description/Default	Range of Values
NRf	The number of the register to be recalled.	1 to 10

Error Message

If the register does not contain a saved state error -224, "Illegal parameter value" occurs.

***RST**

***RST**

The *RST (ReSeT) command places the power meter in a known state. The power meter is reset to the state shown in Table 11-1 on page 11-6.

Syntax

***RST** →

***SAV <NRf>**

The ***SAV <NRf>** (SAVe) command stores the current state of the power meter in the specified register.

Syntax

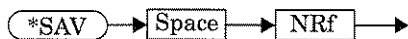

Parameters

Item	Description/Default	Range of Values
NRf	The number of the register that the current state of the power meter is to be saved to.	1 to 10

SRE <NRf>**SRE <NRf>**

The *SRE <NRf> command sets the Service Request Enable register bits. This register contains a mask value for the bits to be enabled in the Status Byte Register. A 1 in the Enable Register enables the corresponding bit in the Status Byte Register; a 0 disables the bit. The parameter value, when rounded to an integer and expressed in base 2, represents the bits 0 to 5 and bit 7 of the Service Request Enable Register. Bit 6 is always 0. Table 14-5 shows the contents of this register. Refer to the pullout at the end of chapter 1 for further information.

Table 14-5: *SRE Mapping

Bit	Weight	Meaning
0	1	Not used
1	2	Not used
2	4	Device Dependent
3	8	QUESTionable Status Summary
4	16	Message Available
5	32	Event Status Bit
6	64	Not used
7	128	OPERation Status Summary

Syntax**Parameters**

Type	Description/Default	Range of Values
NRf	A value used to set the Service Request Enable Register.	0 to 255

Query

*SRE?

The query returns the contents of bits 0 to 5 and bit 7 of the Service Request Enable Register. The format of the return is <NR1> in the ranges of 0 to 63 or 128 to 191 (that is, bit 6 is always 0).

STB?**STB?**

The ***STB?** (S**T**atus B**Y**te) query returns bit 0 to 5 and bit 7 of the power meter's status byte and returns the Master Summary Status (MSS) as bit 6. The MSS is the inclusive OR of the bitwise combination (excluding bit 6) of the Status Byte and the Service Request Enable registers. The format of the return is <NR1> in the ranges of 0 to 255. Table 14-6 shows the contents of this register. Refer to the pullout at the end of chapter 1 for further information.

Table 14-6: *STB? Mapping

Bit	Weight	Meaning
0	1	Not used
1	2	Device Dependent 0 - No device status conditions have occurred 1 - A device status condition has occurred
2	4	Error/Event Queue 0 - Queue empty 1 - Queue not empty
3	8	Questionable Status Summary 0 - No QUEStionable status conditions have occurred 1 - A QUEStionable status condition has occurred
4	16	Message Available 0 - no output messages are ready 1 - an output message is ready
5	32	Event Status Bit 0 - no event status conditions have occurred 1 - an event status condition has occurred
6	64	Master Summary Status 0 - power meter not requesting service 1 - there is at least one reason for requesting service
7	128	Operation Status Summary 0 - No OPERation status conditions have occurred 1 - An OPERation status condition has occurred

Syntax

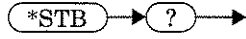

*TRG

The *TRG (TRiGger) command triggers all channels that are in the “wait-for-trigger” state. It has the same effect as Group Execute Trigger (GET).

Using the *DDT command may change the function of the *TRG command.

Syntax

***TRG** →

Error Message

If TRIGger: SOURce is not set to BUS then error -211, “Trigger ignored” occurs.

If the power meter is not in the “wait-for-trigger” state then error -211, “Trigger ignored” occurs.

***TST?**

The ***TST?** (TeST) query causes the power meter to perform the HP-IB self test which takes approximately 30 seconds. The HP-IB self test consists of the following tests:

- ROM checksum
- RAM
- Battery
- Display Assembly
- Calibrator
- Measurement Assembly
- Communications Assembly (Implicit)

The result of the test is placed in the output queue.

- 0 is returned if the test passes.
- 1 if the test fails.

Syntax



***WAI**

***WAI**

The *WAI (WAI) command causes the power meter to wait until either:

- all pending operations are complete,
- the device clear command is received,
- power is cycled,

before executing any subsequent commands or queries.

Syntax

***WAI** →

Index

Symbols

*STB? 1-70

A

abort command 12-3
address 1-3, 11-3
analog display 5-7
analog meter
 setting the lower limit 5-10
 setting the upper limit 5-12
auto averaging 1-38
autoranging 9-49
averaging 1-38, 9-5
 enabling and disabling 9-7
averaging, enabling and disabling 9-10

B

boolean definition 1-84
brightness, of display 5-3

C

CALCulate subsystem 3-1
CALCulate subsystem reference 1-93
calibrating 4-3, 4-5, 4-7
calibrating summary register 10-12
calibration 1-8
calibration factor 9-23
calibration factors
 entering into tables 7-26
CALibration subsystem reference 1-93
calibration summary register 10-21
caution v
channel offset
 enabling and disabling 9-27
channel offsets 1-41
character response data definition 1-85
clear status command 14-7
command set 1-4

condition register 1-60
configuration 1-3, 2-2-??
contrast 5-3

D

danger v
data format 6-2
data types
 SCPI 1-84
define device trigger command 14-8
delay, triggering 12-9
device status register 10-8
difference measurement 3-8
digital display 5-7
display
 selecting single or dual 5-17
 selecting the format 5-7
display contrast 5-3
display offset
 enabling 3-6
 setting the value 3-4
display offsets 1-41
DISPlay subsystem 5-2
DISPlay Subsystem reference 1-94
display, enabling and disabling 5-5
dual window 5-17
duty cycle 1-46, 9-18
 enabling and disabling 9-21

E

editing sensor calibration tables 1-30
enable register 1-61
enabling sensor calibration tables 1-35
error messages 11-4
errors 1-70
event register 1-60
event status enable command 14-10
expressions 3-10

F

- fail counter
 - clearing 9-37, 9-39
- fail limits 1-43
- failures 9-40
- FCO clearing 9-37, 9-39
- filter length 1-40, 9-5
- filtering
 - enabling and disabling 9-7
- format 6-2
- FORMat Subsystem reference 1-94
- frequency 9-34
 - entering into tables 7-22

G

- gain 9-23
- gain correction 9-24
 - enabling and disabling 9-27
- general status register 1-60
- GPIB 11-3
- GP-IB address 1-3

H

- HP 437B command summary 1-5
- HP-IB 11-3
- HP-IB address 1-3

I

- identification command 14-12
- idle state 12-3
- IEEE commands 14-1
- initiate command 12-4
- introduction 1-82

L

- language 11-5
- language selection 1-4
- legal information iii
- limit
 - setting on the analog meter 5-10, 5-12
- limit failures 9-40
 - amount of 9-41
- limits 1-43
 - enabling 9-43, 9-45
 - lower 9-43
 - upper 9-46

- listing sensor calibration tables 1-31
- loss 9-29
 - enabling and disabling 9-32
- loss correction 9-30
- lower limit
 - setting on the analog meter 5-10
- lower limit fail summary register 10-13
- lower test limit 9-43

M

- making measurements 2-2-??
- math expression 3-8
- MEASurement commands reference 1-92
- measurement units 13-3, 13-6
- measurements 2-2-??
 - using CONFigure Command 1-17
 - using INITiate 1-17
 - using READ? 1-17
- measuring summary register 10-14
- memory subsystem 7-2
- MEMory subsystem reference 1-95
- memory, amount available 7-13, 7-14, 7-15

N

- naming sensor calibration tables 1-33
- NAN 1-85, 1-88
- non-decimal numeric definition 1-86
- NR1 definition 1-87
- NR2 definition 1-87
- NR3 definition 1-88
- NRf definition 1-87
- numeric value definition 1-88

O

- offsets 1-41
- operation complete command 14-13
- operation complete commands 1-78
- operation register sets 10-10
- operation status 1-74
- operation status register 10-11
- OUTPut subsystem reference 1-95
- overview viii

P

- pass limits 1-43
- polling 1-63

- power reference 8-3
- power summary register 10-22
- preset 11-6
- preset, values of status registers 10-18
- programming language 11-5
- programming language selection 1-4
- pulse power 9-18, 9-21
- pulsed signals 1-46

Q

- questionable register set 10-19
- questionable status register 1-72

R

- range 1-37
- ranges
 - auto 9-49
 - selecting 9-48
- ratio measurement 3-8
- recall 1-80
 - registers available 7-16
- recall command 14-15
- recall register
 - clearing data 7-10
 - listing 7-4, 7-6, 7-18
 - naming 7-19
- reference calibration factor 4-2
 - querying 1-10
 - setting 1-10, 4-9
- reference value
 - setting 3-12
- registers, available for save/recall 7-16
- relative value
 - enabling 3-14
 - setting 3-12
- reset command 14-16
- resolution 1-38, 5-14

S

- safety v
- save 1-80
- save command 14-17
- save/recall
 - registers available 7-16
- save/recall register
 - clearing data 7-10

- listing 7-4, 7-6, 7-18
- naming 7-19
- SCPI an introduction 1-82
- SCPI data types 1-84
- SCPI language 1-82
- SCPI version 11-9
- screen, enabling and disabling 5-5
- selecting a sensor calibration table 1-35
- self test query 14-23
- sense subsystem 9-2
- SENSE Subsystem reference 1-96
- sense summary register 10-15
- sensor calibration table 7-2
 - clearing data 7-10, 7-11
 - enabling and disabling 9-15
 - entering calibration factors 7-26
 - entering frequency 7-22
 - listing 7-4, 7-7
 - naming 7-29
 - selecting 1-35, 7-30, 9-13
- sensor calibration tables 1-27
 - editing 1-30
 - enabling 1-35
 - listing 1-31
 - naming 1-33
- service request enable register 14-18
- service request generation 1-70
- single window 5-17
- speed 9-51
- SRQ 1-64
- standard event register 1-70
 - bit definitions 1-70
- standard event status register 14-11
- status byte 1-69
 - bit definitions 1-69
- status byte query 14-20
- status register 1-68
- status register set 10-4
- status reporting 1-59
- status subsystem 10-2
- STATus subsystem reference 1-97
- string definition 1-89
- summary register 1-69
- system subsystem 11-2
- SYSTEM subsystem reference 1-98

T

- test limits
 - enabling 9-43, 9-45
 - lower 9-43
 - upper 9-46
- transition filter 1-60
- trigger
 - delay 1-53
- trigger command 14-22
- trigger immediate 12-11
- trigger source 12-12
- trigger subsystem 12-2
- TRIGger subsystem reference 1-98
- trigger summary register 10-16
- trigger system 12-8
- triggering 1-49

U

- unit subsystem 13-2
- UNIT subsystem reference 1-98
- units 13-3, 13-6
- upper limit
 - setting on the analog meter 5-12
- upper limit fail summary register 10-17
- upper test limit 9-46

V

- version 11-9

W

- wait command 14-24
- wait for trigger state 12-4
- warning v
- warranty iii
- window
 - selecting single or dual 5-17
- window resolution 5-14
- window selection 5-16

X

- x2 mode 1-54

Z

- zeroing 1-8, 4-2, 4-11

Free Manuals Download Website

<http://myh66.com>

<http://usermanuals.us>

<http://www.somanuals.com>

<http://www.4manuals.cc>

<http://www.manual-lib.com>

<http://www.404manual.com>

<http://www.luxmanual.com>

<http://aubethermostatmanual.com>

Golf course search by state

<http://golfingnear.com>

Email search by domain

<http://emailbydomain.com>

Auto manuals search

<http://auto.somanuals.com>

TV manuals search

<http://tv.somanuals.com>